



US00D900228S

(12) **United States Design Patent**
Schultheis

(10) **Patent No.:** **US D900,228 S**

(45) **Date of Patent:** **** Oct. 27, 2020**

(54) **PLAYING SURFACE FOR SPINNING TOP TOY**

(71) Applicant: **TOMY COMPANY, LTD.**, Tokyo (JP)

(72) Inventor: **Douglas Arthur Schultheis**,
Cumberland, RI (US)

(73) Assignee: **TOMY COMPANY LTD.**, Tokyo (JP)

(**) Term: **15 Years**

(21) Appl. No.: **29/703,924**

(22) Filed: **Aug. 30, 2019**

(51) **LOC (12) Cl.** **21-01**

(52) **U.S. Cl.**
USPC **D21/338; D21/461**

(58) **Field of Classification Search**
USPC D21/334, 336-342, 355-359, 365, 318,
D21/397, 312, 314, 320, 362, 366, 367,
D21/385, 455, 456, 460, 461, 484,
D21/491-501, 561, 564; 273/242,
273/244-247, 259, 277, 287, 317.3,
273/108.1, 108.5, 118 D, 236-240, 283,
273/309, 441, 461, 108.2, 108.3, 113,
273/115, 116, 241, 280, 282.1, 282.2,
273/282.3, 289, 148 R, 440, 444, 450,
273/453, 459, 109, 110, 108, 456, 443;
D6/406.1, 406.3, 406.4, 406.6; D19/86,
D19/92, 95, 87, 113, 75, 77, 78, 80;
108/14, 62, 43, 67; 434/416, 247, 248,
434/251, 408, 413, 145, 430; 446/82,
446/168, 236, 256, 257, 259, 262, 263,
446/491, 233; D7/538-550.1, 552.2,
D7/553.1-553.8, 554.1-554.4, 558,
D7/584-588, 601, 602, 359, 354, 356;
D9/737, 756, 758-761, 414, 424-433,
D9/456, 499; D30/121, 129-133;
D11/143, 144, 152, 153, 155, 156, 164;

(Continued)

(56) **References Cited**

U.S. PATENT DOCUMENTS

581,365 A * 4/1897 Parker A63F 7/044
273/113
845,811 A * 3/1907 Osgood A63F 9/16
273/108

(Continued)

Primary Examiner — Susan Moon Lee

(74) *Attorney, Agent, or Firm* — Oliff PLC

(57) **CLAIM**

The ornamental design for a playing surface for spinning top toy, as shown and described.

DESCRIPTION

FIG. 1 is a front elevational view of the playing surface for spinning top toy;
FIG. 2 is a rear elevational view thereof;
FIG. 3 is a left-side elevational view thereof;
FIG. 4 is a right-side elevational view thereof;
FIG. 5 is a top plan view thereof;
FIG. 6 is a bottom plan view thereof;
FIG. 7 is a front, right-side, top perspective view thereof;
FIG. 8 is a rear, left-side, bottom perspective view thereof;
FIG. 9 is a Front, right-side and top disassembled perspective view, showing a state separating into clips, cover, base and legs;
FIG. 10 is a rear, left-side, bottom disassembled perspective view, showing a state of being separated into clips, cover, base, and legs;
FIG. 11 is a perspective view of only one of the clips;
FIG. 12 is a another perspective view of the clip;
FIG. 13 is a perspective view of only one of the legs; and,
FIG. 14 is a another perspective view of only the leg.

1 Claim, 11 Drawing Sheets

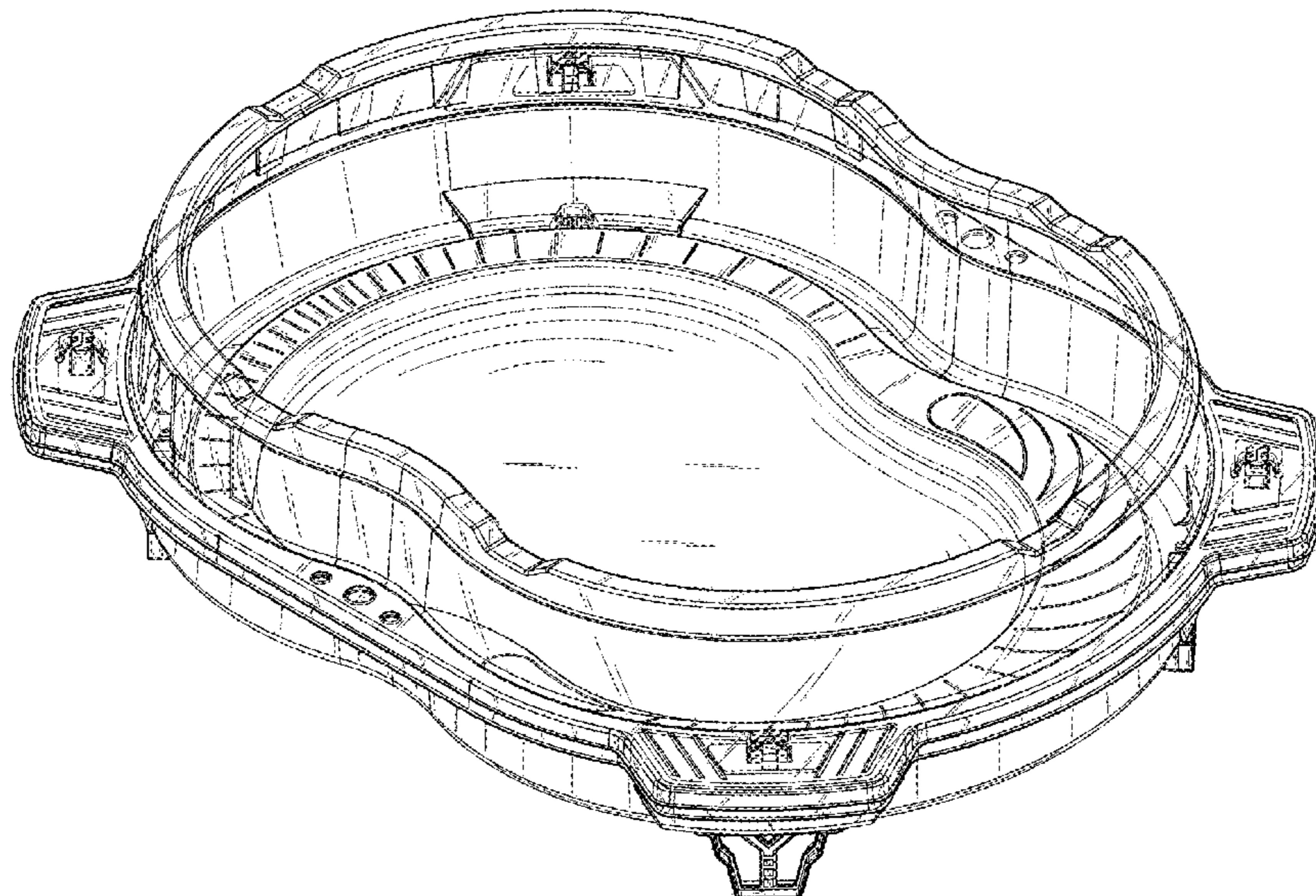

US D900,228 S

(58) Field of Classification Search

USPC 47/65, 65.5, 65.6, 66.7, 71, 73-75, 39;
 473/569, 570; 463/69
 CPC A63F 3/00; A63F 3/00003; A63F 3/0009;
 A63F 3/00041; A63F 3/00044; A63F
 3/00047; A63F 3/00173; A63F 3/00176;
 A63F 3/00214; A63F 3/00261; A63F
 3/00643; A63F 3/00646-00659; A63F
 3/04; A63F 2003/00182; A63F
 2003/00223; A63F 2003/00457; A63F
 2003/0046; A63F 2003/00463; A63F
 2003/00466; A63F 2003/0047; A63F
 2003/00485; A63F 2003/00492; A63F
 2003/00507; A63F 2003/00514; A63F
 2003/00533; A63F 2003/00552; A63F
 2003/00558; A63F 2003/00943; A63F
 2003/00946; A63F 2003/00952-00962;
 A63F 2003/00974; A63F 7/00; A63F
 7/06; A63F 7/0612; A63F 7/0616-0636;
 A63F 7/30; A63F 7/36; A63F 7/0005;
 A63F 7/0017; A63F 7/0023; A63F
 2007/0035; A63F 2007/367; A63F
 2007/3674; A63F 7/0604; A63F 9/00;
 A63F 9/16; A63F 9/02; A63F 2009/165;
 A63H 1/00; A63H 1/02; A63H 1/04;
 A63H 1/10

See application file for complete search history.

(56) References Cited

U.S. PATENT DOCUMENTS

2,083,119 A * 6/1937 Hense A63F 5/0088
 273/119 R
 2,433,995 A * 1/1948 Kevers A63F 7/0058
 273/119 A
 2,517,324 A * 8/1950 Kurose A63F 9/14
 463/69
 2,796,211 A * 6/1957 Wagner A24F 19/0028
 229/104
 3,208,185 A * 9/1965 Silvera A63F 7/3075
 446/137
 D209,410 S * 11/1967 Grant D21/374
 D222,492 S * 10/1971 Miller et al. D21/456
 3,643,951 A * 2/1972 Breslow A63F 7/02
 273/108
 3,643,954 A * 2/1972 Meyer A63F 9/02
 273/119 A
 3,674,271 A * 7/1972 De Gelder A63H 1/00
 273/115
 3,712,619 A * 1/1973 Goldfarb A63F 9/16
 273/108
 3,815,911 A * 6/1974 Cooper A63F 9/16
 463/69
 D246,197 S * 10/1977 Iwanami D21/590
 D246,609 S * 12/1977 Kanno D21/312
 4,061,334 A * 12/1977 Kanno A63F 9/02
 273/126 A
 4,076,245 A * 2/1978 Monroe A63F 9/14
 446/444
 4,200,283 A * 4/1980 Andrews A63F 9/16
 273/108
 D256,308 S * 8/1980 Zimmermann D11/143
 4,292,756 A * 10/1981 Jaworski A63H 1/00
 446/246
 4,332,385 A * 6/1982 McCaslin A63F 7/041
 273/113
 4,630,822 A * 12/1986 Massaglia A63F 9/16
 273/118 A

4,648,602 A * 3/1987 Maroney A63F 9/0402
 273/146
 D303,231 S * 9/1989 Mottmiller D11/143
 4,982,961 A * 1/1991 Ichimura A63F 9/16
 273/109
 D345,437 S * 3/1994 Bruno D27/105
 5,342,064 A * 8/1994 Williamson A63F 9/30
 273/447
 5,415,401 A * 5/1995 Nagasaka A63F 7/027
 273/109
 5,516,112 A * 5/1996 Rypinski A63F 9/0402
 273/287
 5,782,351 A * 7/1998 Shoptaugh B65D 51/249
 206/315.1
 6,032,827 A * 3/2000 Zettle B65D 43/0212
 220/788
 D563,102 S * 3/2008 Cornwell D3/294
 D563,671 S * 3/2008 Cornwell D3/294
 D606,125 S * 12/2009 Ujita D21/397
 D606,126 S * 12/2009 Ujita D21/397
 D644,559 S * 9/2011 Hashimoto D11/143
 D715,623 S * 10/2014 Holtby D8/356
 9,566,532 B1 * 2/2017 Walterscheid A63H 15/04
 D795,695 S * 8/2017 Snedden D9/456
 D806,801 S * 1/2018 Shindo D21/338
 D811,487 S * 2/2018 Shindo D21/338
 D834,651 S * 11/2018 Schultheis D21/338
 D838,316 S * 1/2019 Shindo D21/461
 D859,531 S * 9/2019 Matsukawa D21/338
 D869,560 S * 12/2019 Schultheis D21/338
 D883,389 S * 5/2020 Schultheis D21/338
 D884,078 S * 5/2020 Hama D21/338
 D884,797 S * 5/2020 Schultheis D21/338
 D886,903 S * 6/2020 Ishii D21/338
 2003/0064660 A1 * 4/2003 Matsukawa A63H 1/04
 446/256
 2003/0199222 A1 * 10/2003 Matsukawa A63H 30/04
 446/256
 2007/0021029 A1 * 1/2007 Weidetz A63H 1/04
 446/256
 2007/0216090 A1 * 9/2007 Brown A63F 9/16
 273/108
 2008/0242184 A1 * 10/2008 Divnick A63F 7/2409
 446/11
 2009/0188511 A1 * 7/2009 Wu A24F 19/14
 131/231
 2009/0253343 A1 * 10/2009 Kitamura A63F 9/16
 446/256
 2009/0253349 A1 * 10/2009 Iwakoshi A63H 18/14
 446/429
 2010/0051040 A1 * 3/2010 Bathey A24F 19/14
 131/235.1
 2010/0159798 A1 * 6/2010 Bertrand A63H 1/02
 446/259
 2010/0320682 A1 * 12/2010 Derrah A63F 9/14
 273/108.1
 2011/0171876 A1 * 7/2011 Ujita A63H 1/00
 446/264
 2011/0189921 A1 * 8/2011 Andersen A63H 33/22
 446/242
 2011/0256794 A1 * 10/2011 Horikoshi A63H 1/04
 446/259
 2011/0256796 A1 * 10/2011 Ujita A63H 1/00
 446/264
 2013/0056929 A1 * 3/2013 Rehkemper A63H 30/04
 273/129 R
 2016/0030848 A1 * 2/2016 Lema A63F 13/213
 463/9
 2016/0375354 A1 * 12/2016 Francis A63H 1/00
 463/16
 2017/0239558 A1 * 8/2017 Shindo A63F 9/16
 2017/0333783 A1 * 11/2017 Shindo A63H 1/02
 2019/0184278 A1 * 6/2019 Campos A63F 9/16

* cited by examiner

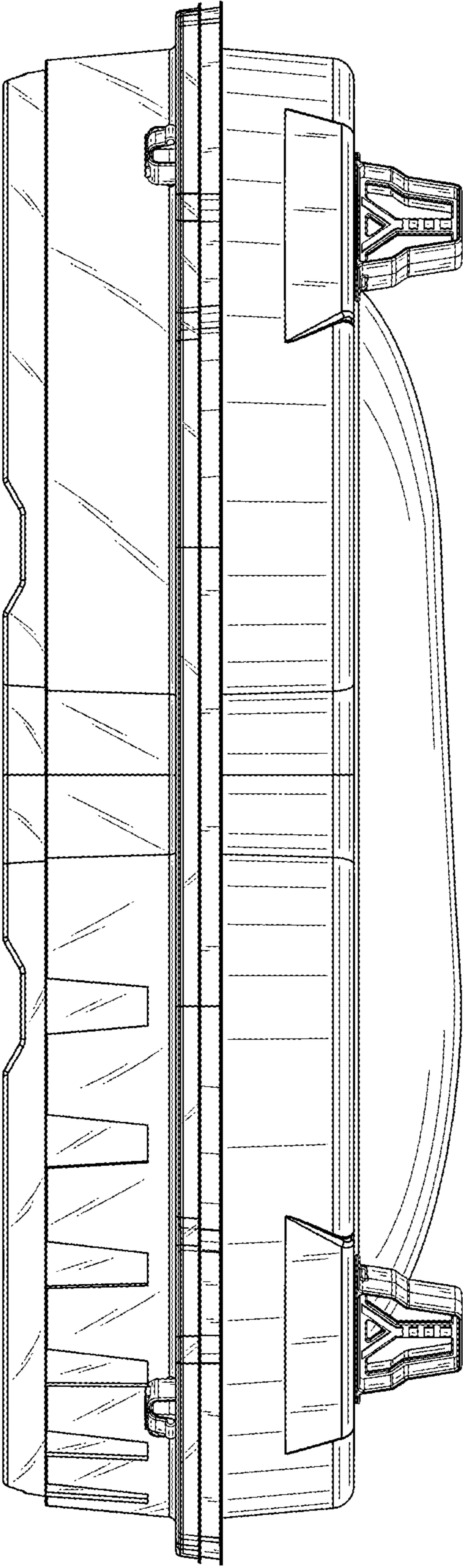

FIG. 1

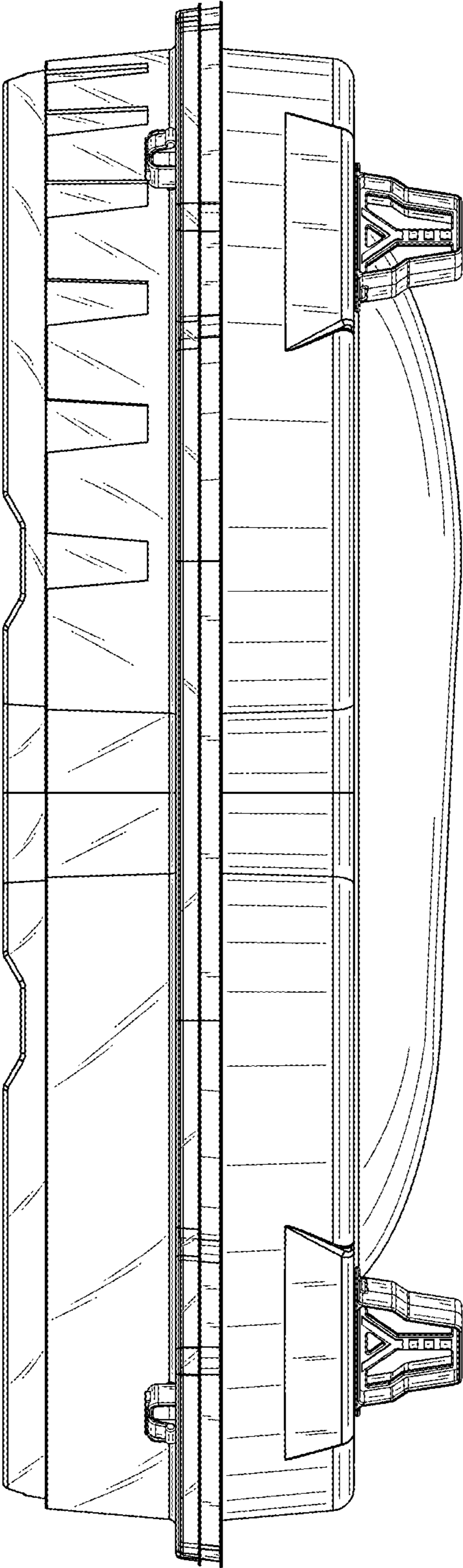

FIG. 2

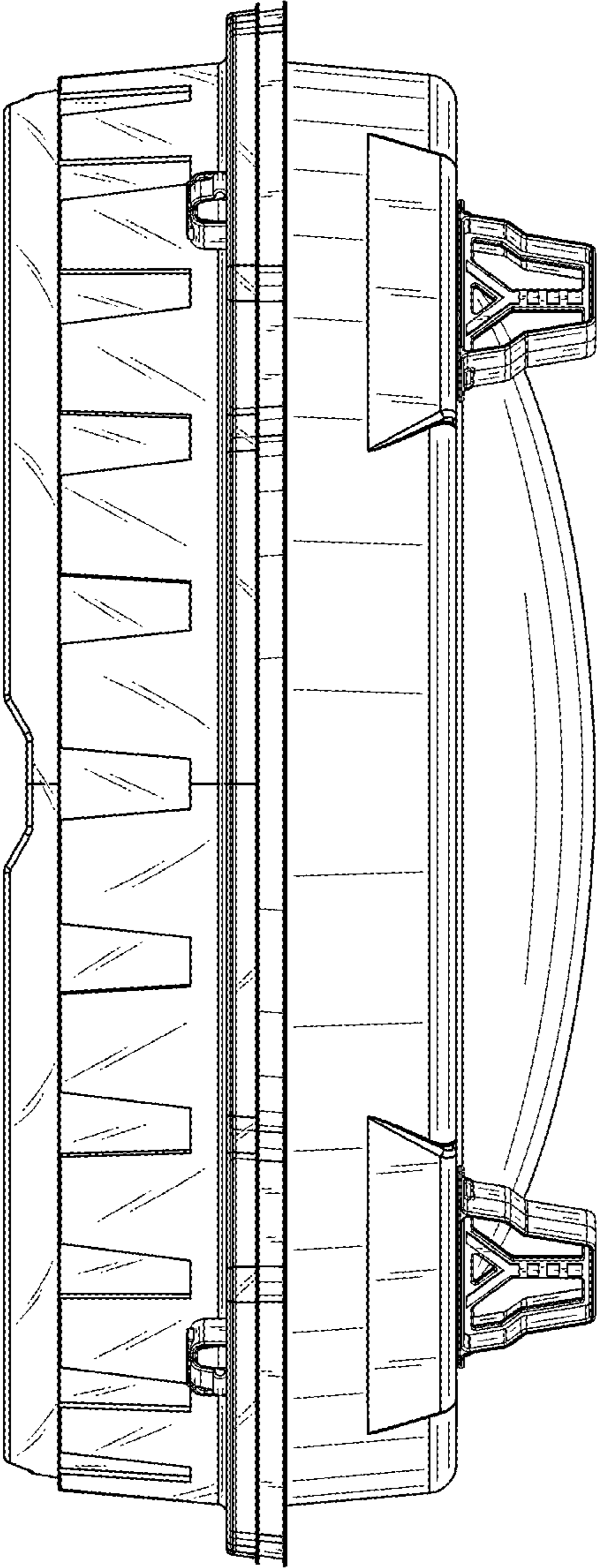

FIG. 3

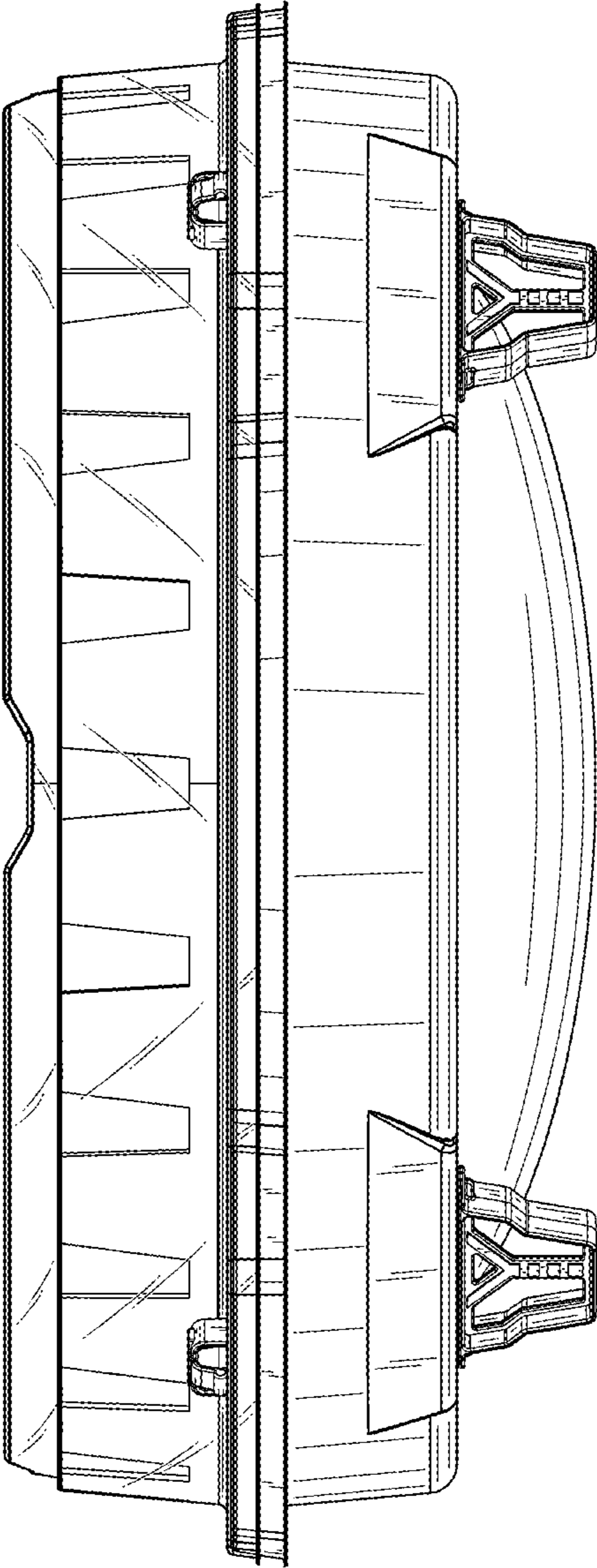

FIG. 4

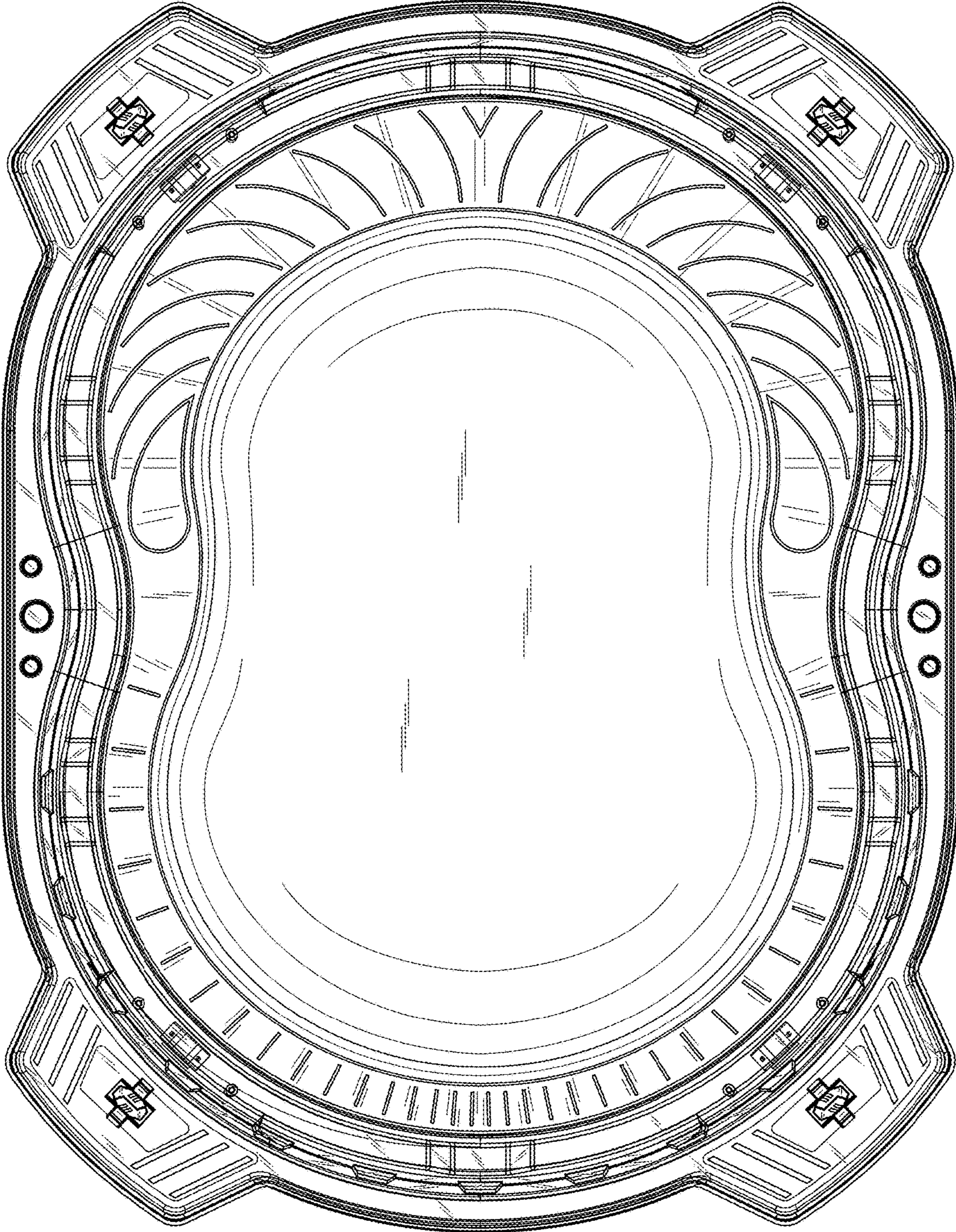

FIG. 5

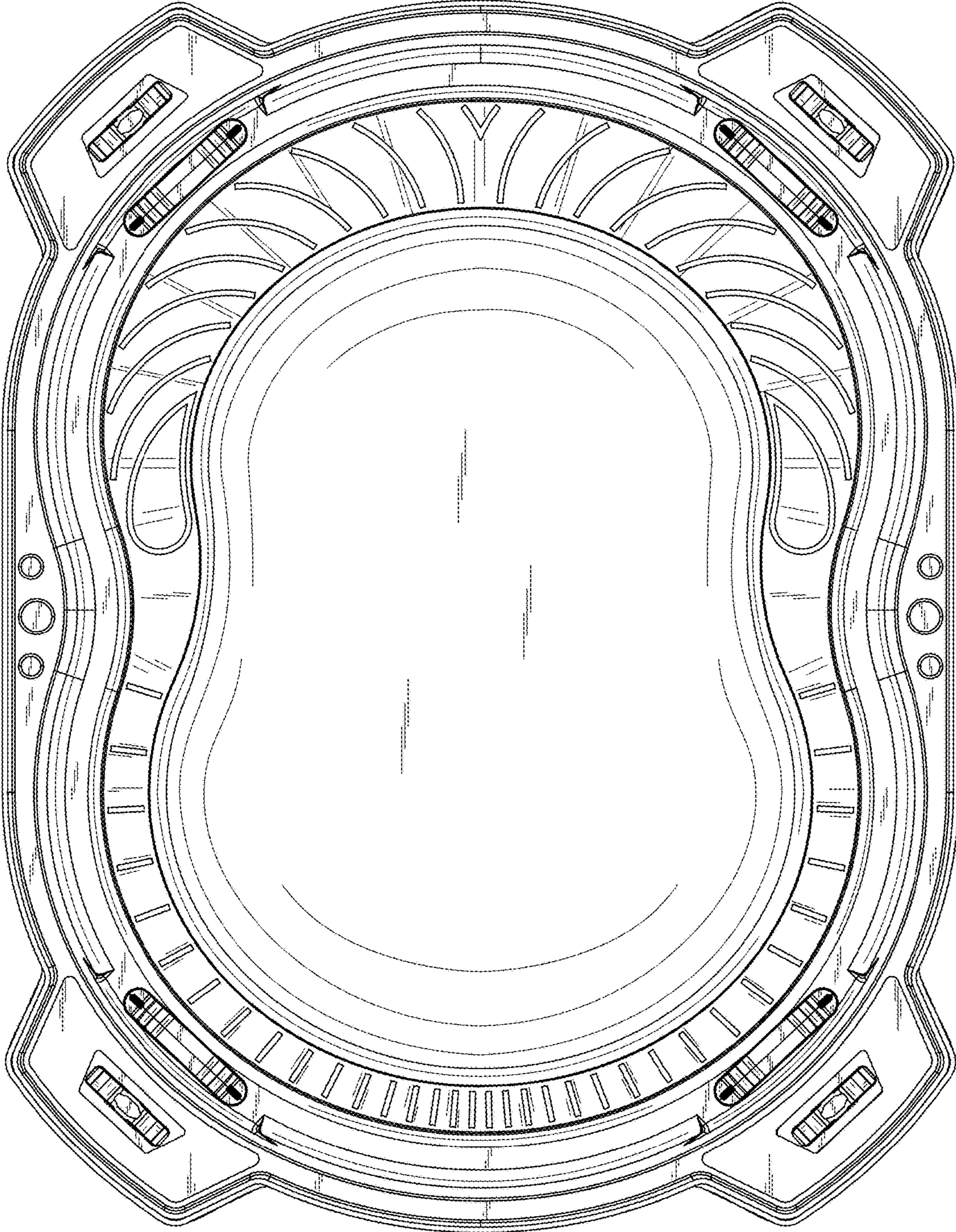

FIG. 6

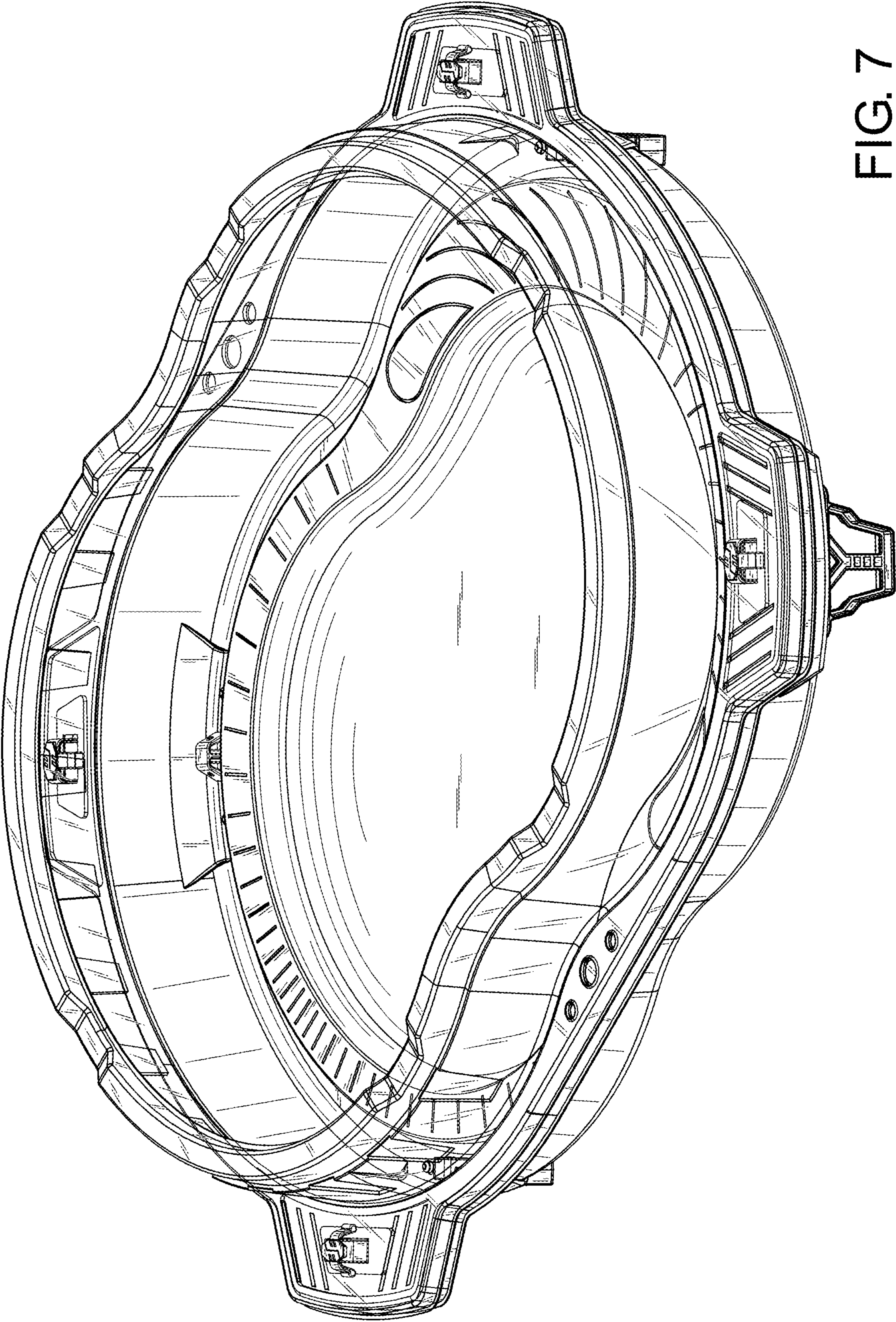

FIG. 7

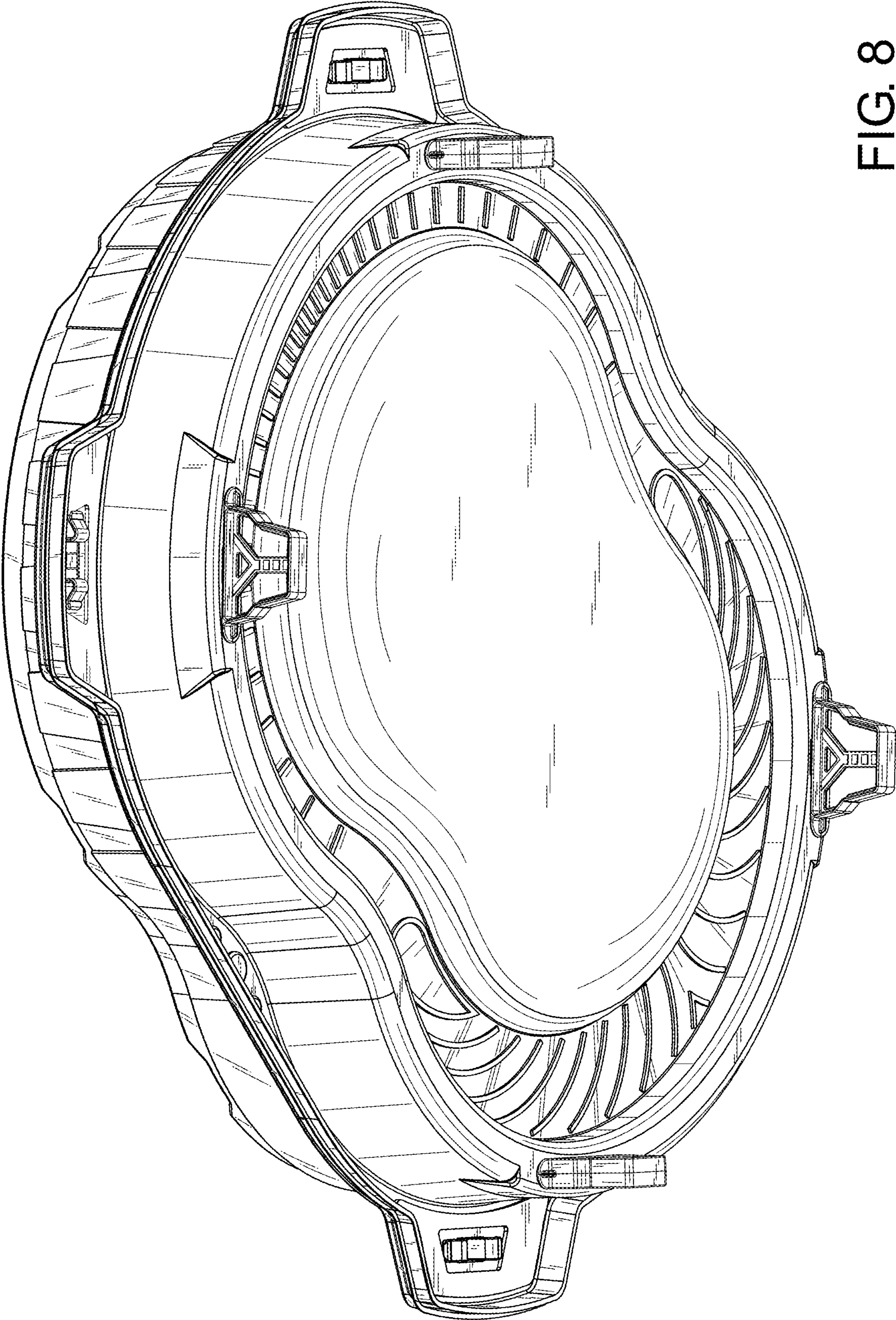

FIG. 8

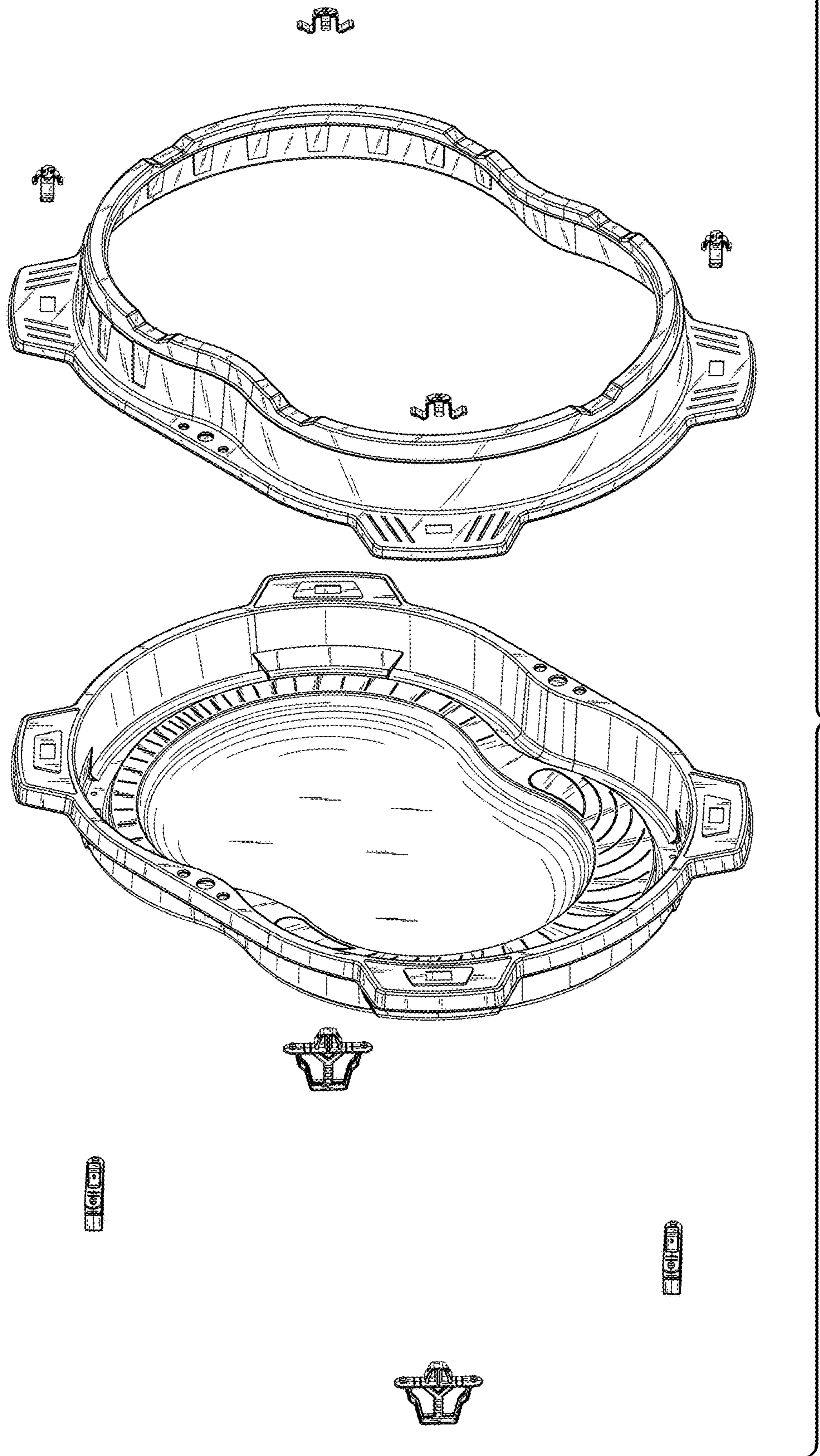

FIG. 9

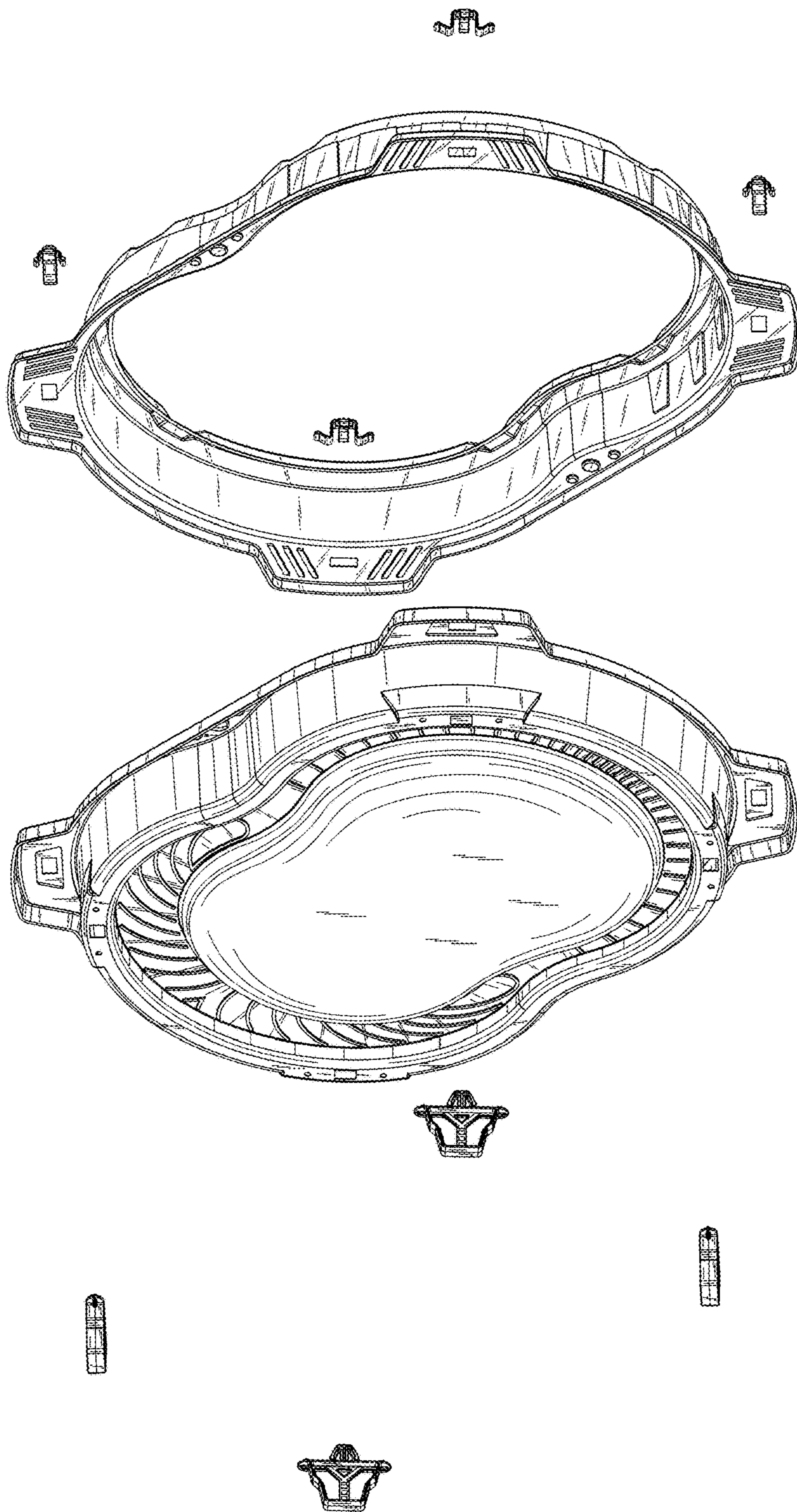

FIG. 10

FIG. 11

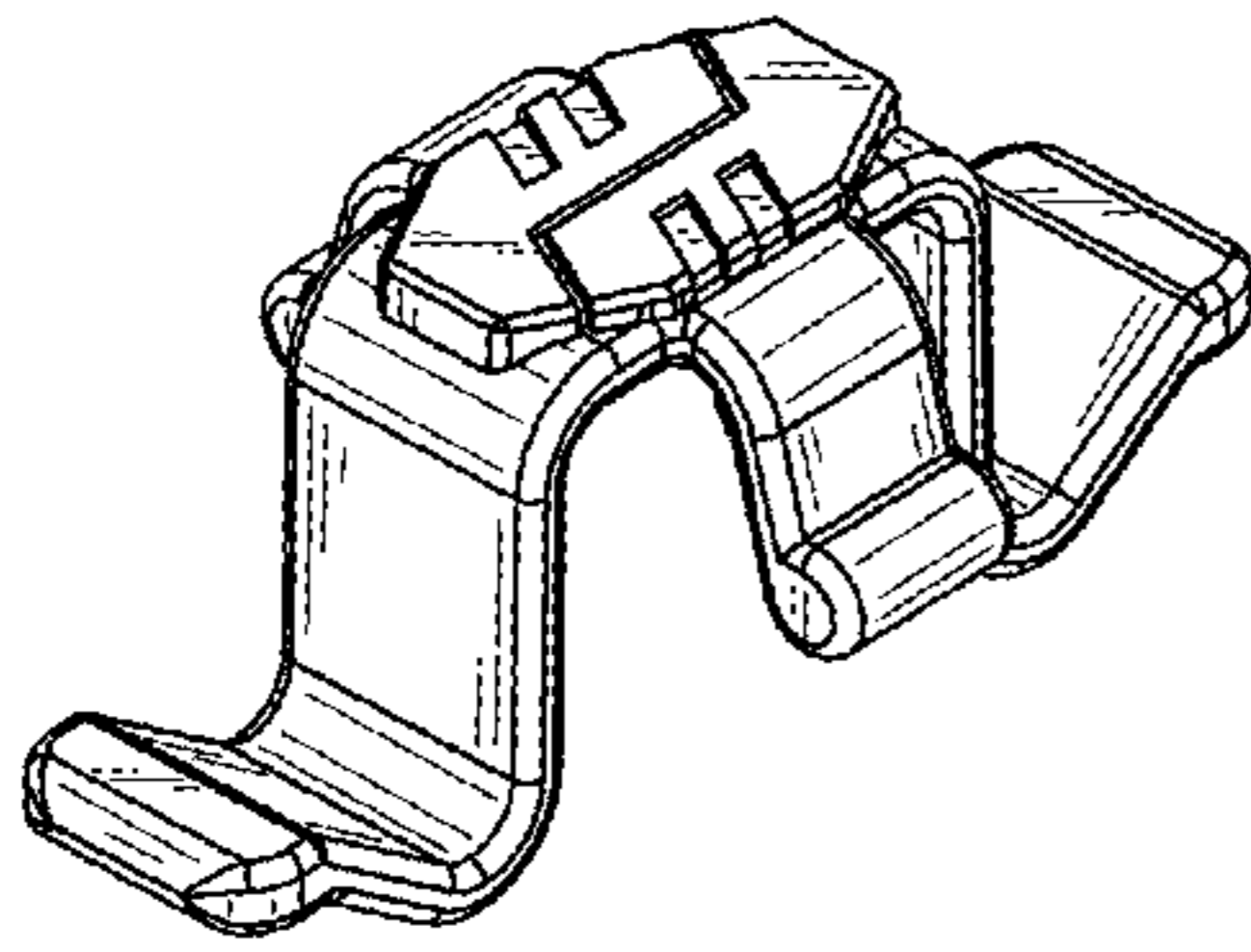

FIG. 12

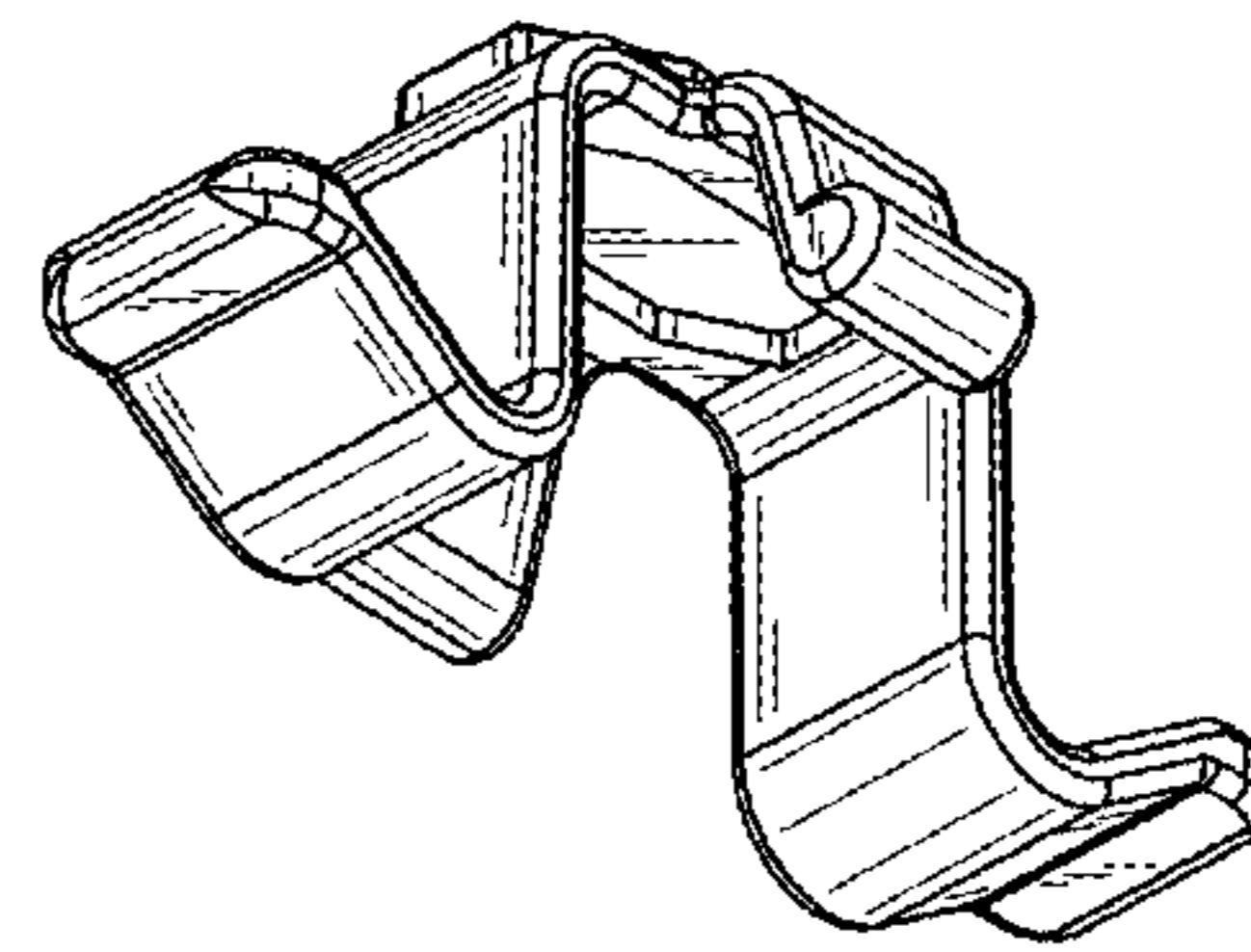

FIG. 13

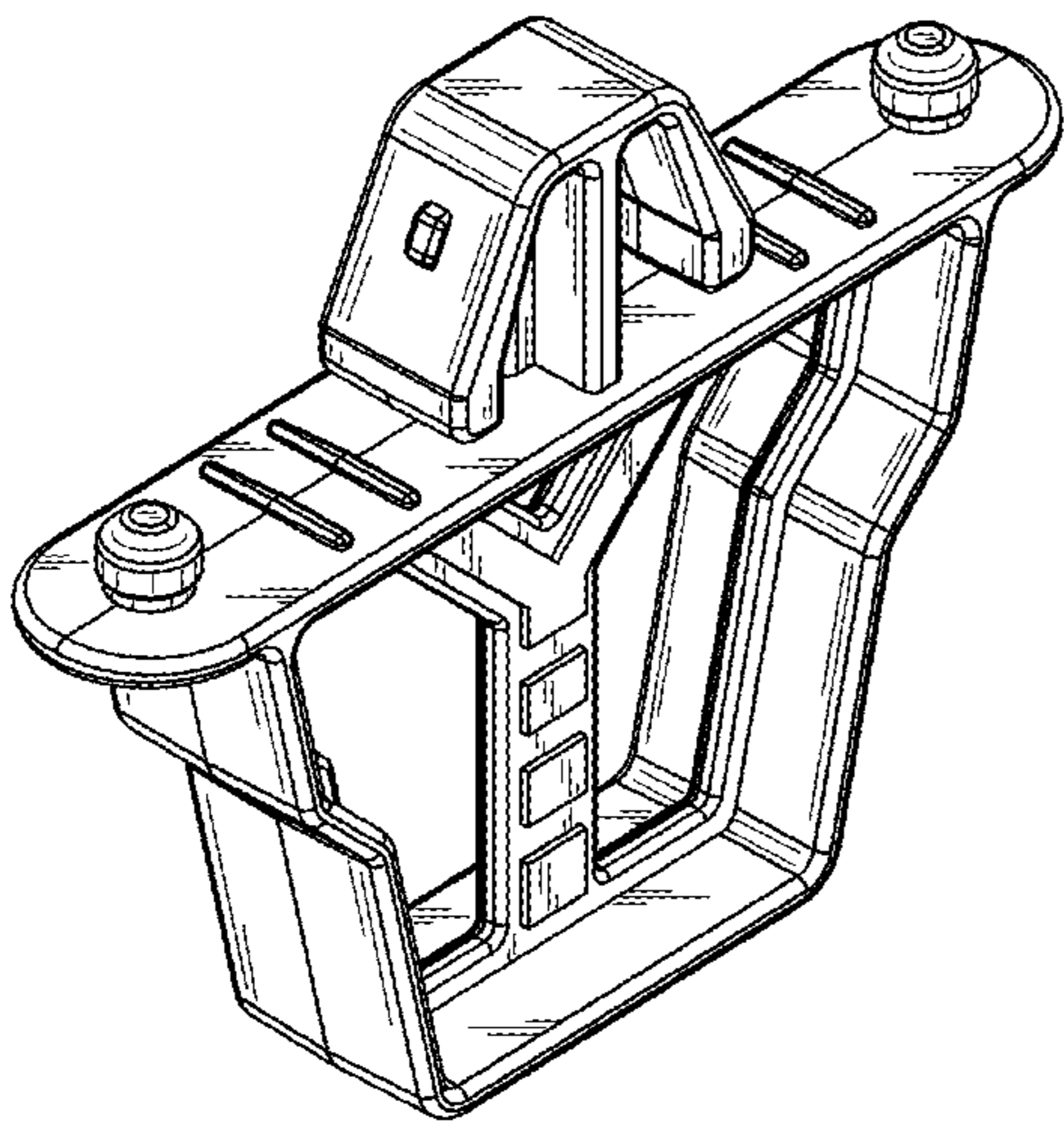

FIG. 14

