



US00D900165S

(12) **United States Design Patent**
Nemoto et al.

(10) **Patent No.:** **US D900,165 S**

(45) **Date of Patent:** **** Oct. 27, 2020**

(54) **FLUID PRESSURE CYLINDER WITH LOCK MECHANISM**

D699,759 S * 2/2014 Peschel D15/7
D699,760 S * 2/2014 Peschel D15/7
D871,457 S * 12/2019 Ikari D15/7
D888,773 S * 6/2020 Sato D15/7

(71) Applicant: **SMC CORPORATION**, Chiyoda-ku (JP)

(72) Inventors: **Shinichiro Nemoto**, Ichikawa (JP);
Masahiko Kawakami, Moriya (JP);
Sho Aso, Adachi-ku (JP)

(73) Assignee: **SMC CORPORATION**, Chiyoda-ku (JP)

(**) Term: **15 Years**

(21) Appl. No.: **29/699,736**

(22) Filed: **Jul. 29, 2019**

(30) **Foreign Application Priority Data**

Feb. 1, 2019 (JP) 2019-002086

(51) **LOC (12) Cl.** **15-02**

(52) **U.S. Cl.**
USPC **D15/7**

(58) **Field of Classification Search**
USPC D15/7, 143, 28, 5, 8, 9; D23/233, 235,
D23/231, 232, 225; 417/60, 235, 265,
417/321, 355, 358, 363, 359, 410.1,
417/415-416, 405, 900
CPC F15B 15/1447; F15B 15/149; F15B
15/1438; F15B 15/1457; F15B 15/222;
F15B 15/2861; F15B 15/1428; F15B
15/1461; F16J 10/02; F16J 1/12; F02M
37/04

See application file for complete search history.

(56) **References Cited**

U.S. PATENT DOCUMENTS

D370,683 S * 6/1996 Stahlman D15/7
D480,405 S * 10/2003 Kleffmann D15/143

OTHER PUBLICATIONS

Japanese Notification of Reason for Refusal dated Oct. 7, 2019, in Design Application No. 2019-002086, 5 pages (with English translation).

* cited by examiner

Primary Examiner — Gino Colan

(74) *Attorney, Agent, or Firm* — Oblon, McClelland, Maier & Neustadt, L.L.P.

(57) **CLAIM**

The ornamental design for a fluid pressure cylinder with lock mechanism, as shown and described.

DESCRIPTION

FIG. 1 is a front elevational view of a fluid pressure cylinder with lock mechanism;
FIG. 2 is a rear elevational view thereof;
FIG. 3 is a top plan view thereof;
FIG. 4 is a bottom plan view thereof;
FIG. 5 is a left side elevational view thereof;
FIG. 6 is a right side elevational view thereof;
FIG. 7 is a front, top, and left side perspective view thereof; and,
FIG. 8 is a rear, bottom, and right side perspective view thereof.
The broken lines shown in the figures illustrate portions of the fluid pressure cylinder with lock mechanism that form no part of the claimed design.

1 Claim, 7 Drawing Sheets

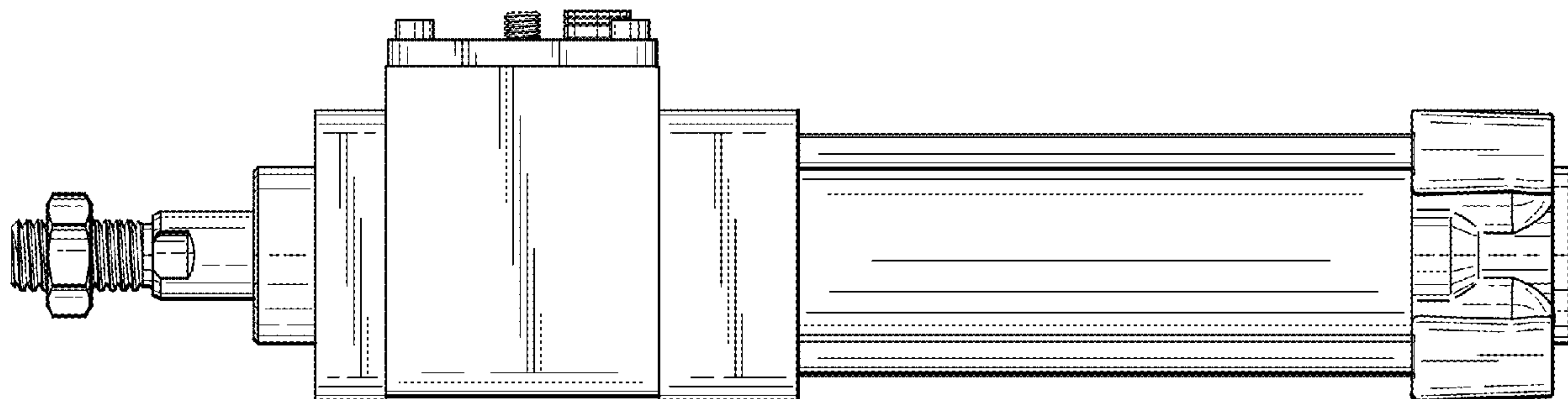

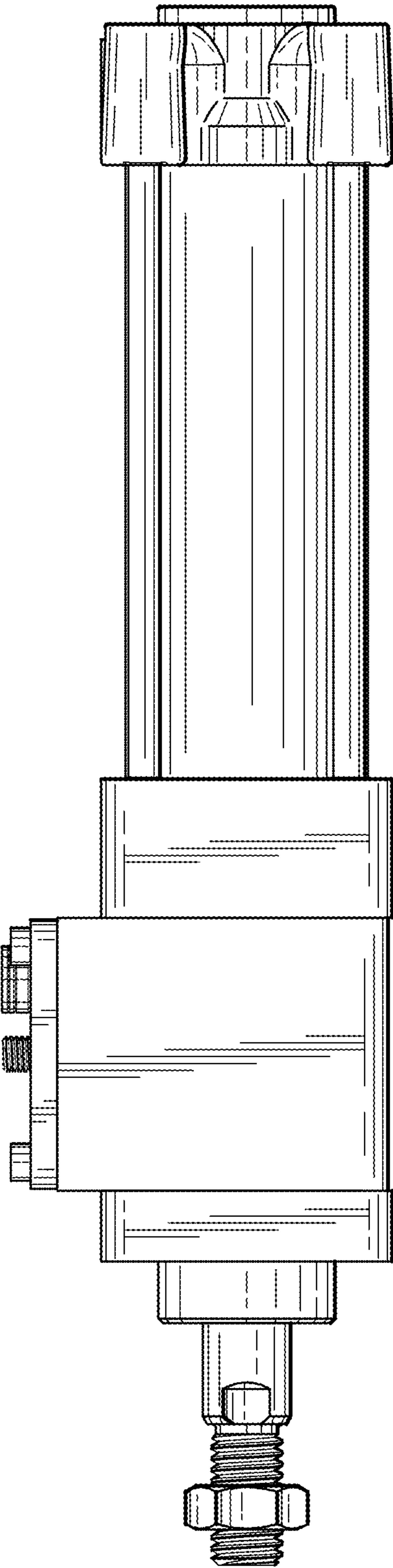

FIG. 1

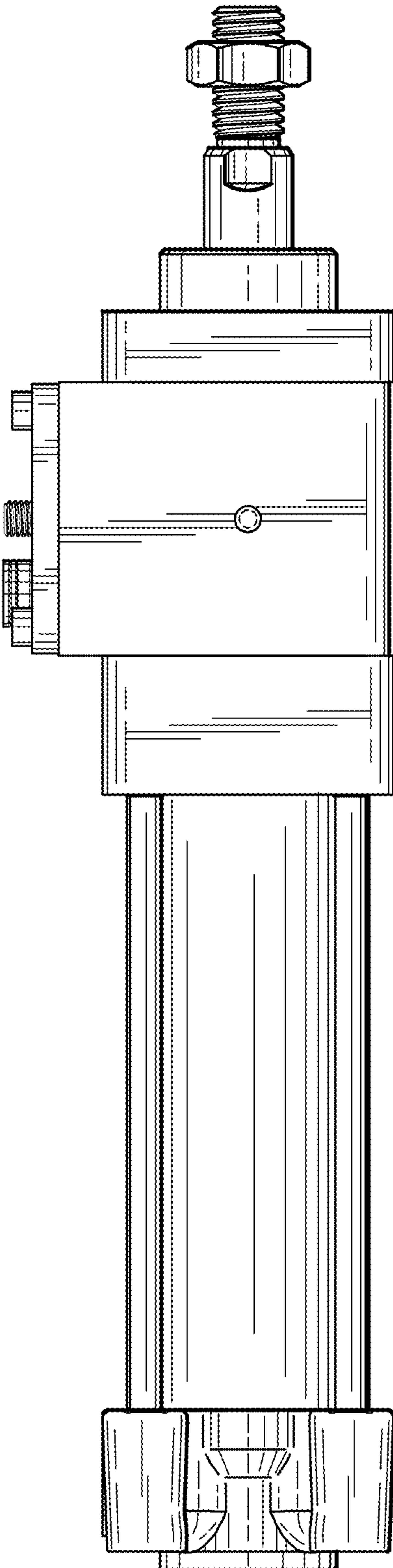

FIG. 2

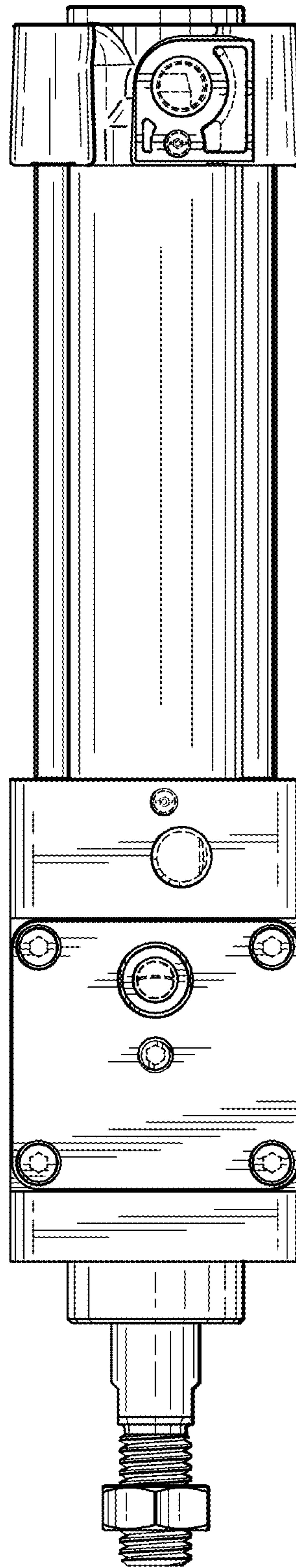

FIG. 3

FIG. 4

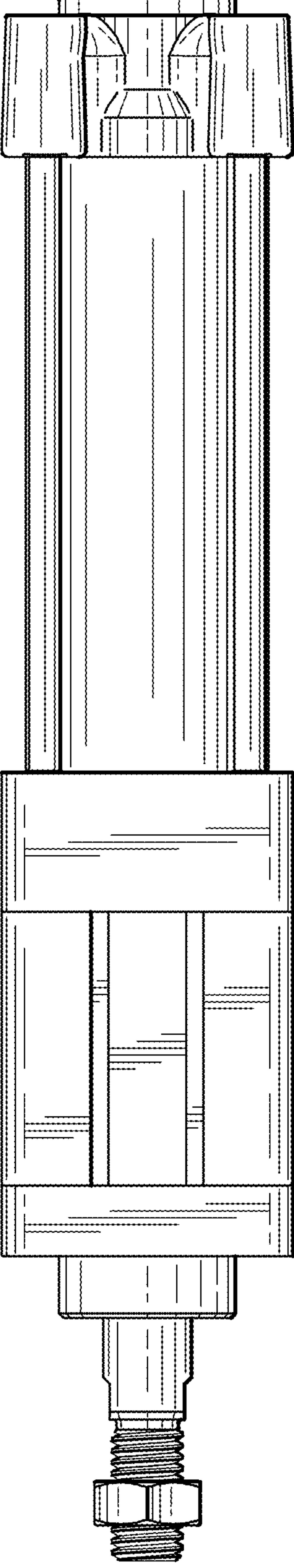

FIG. 6

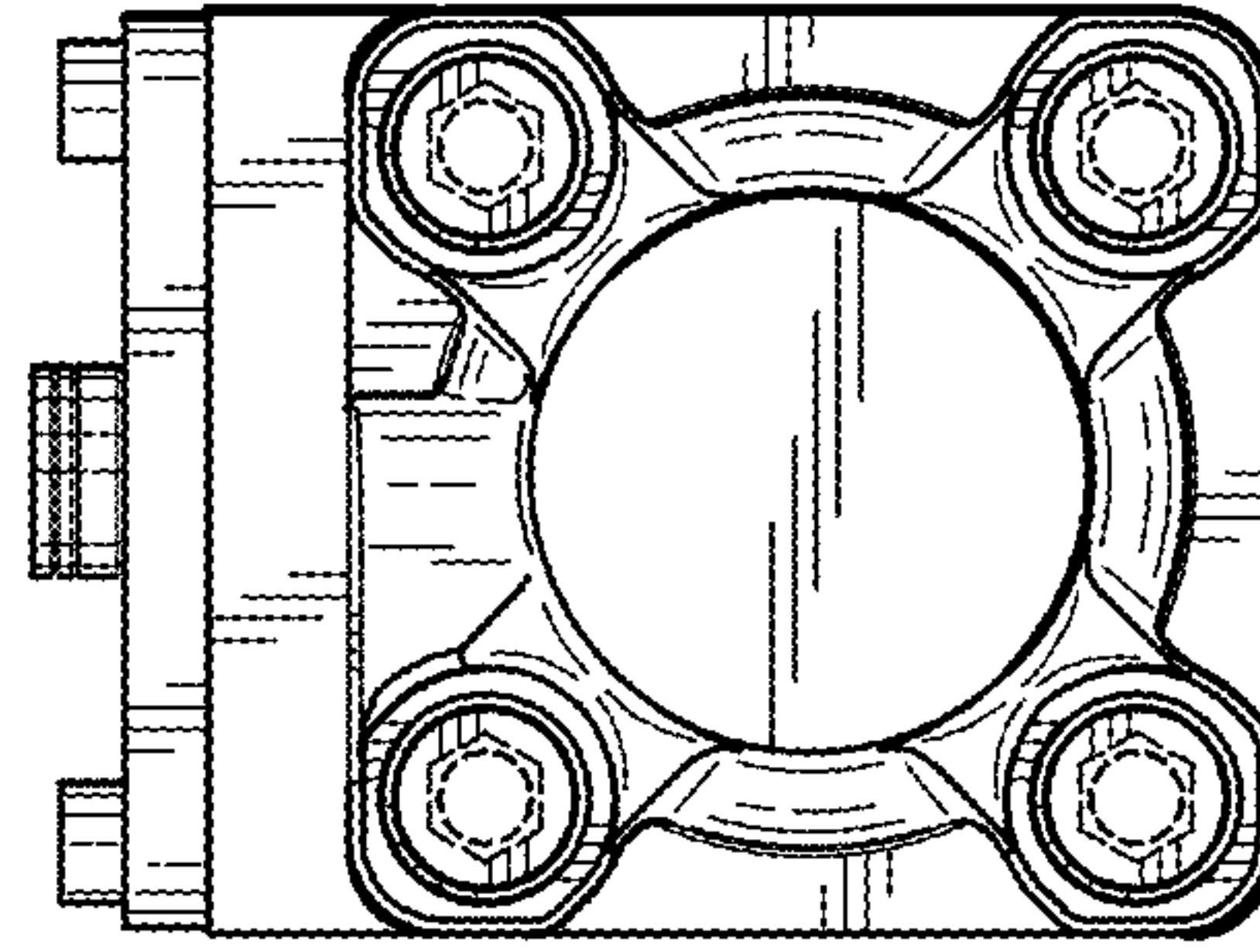
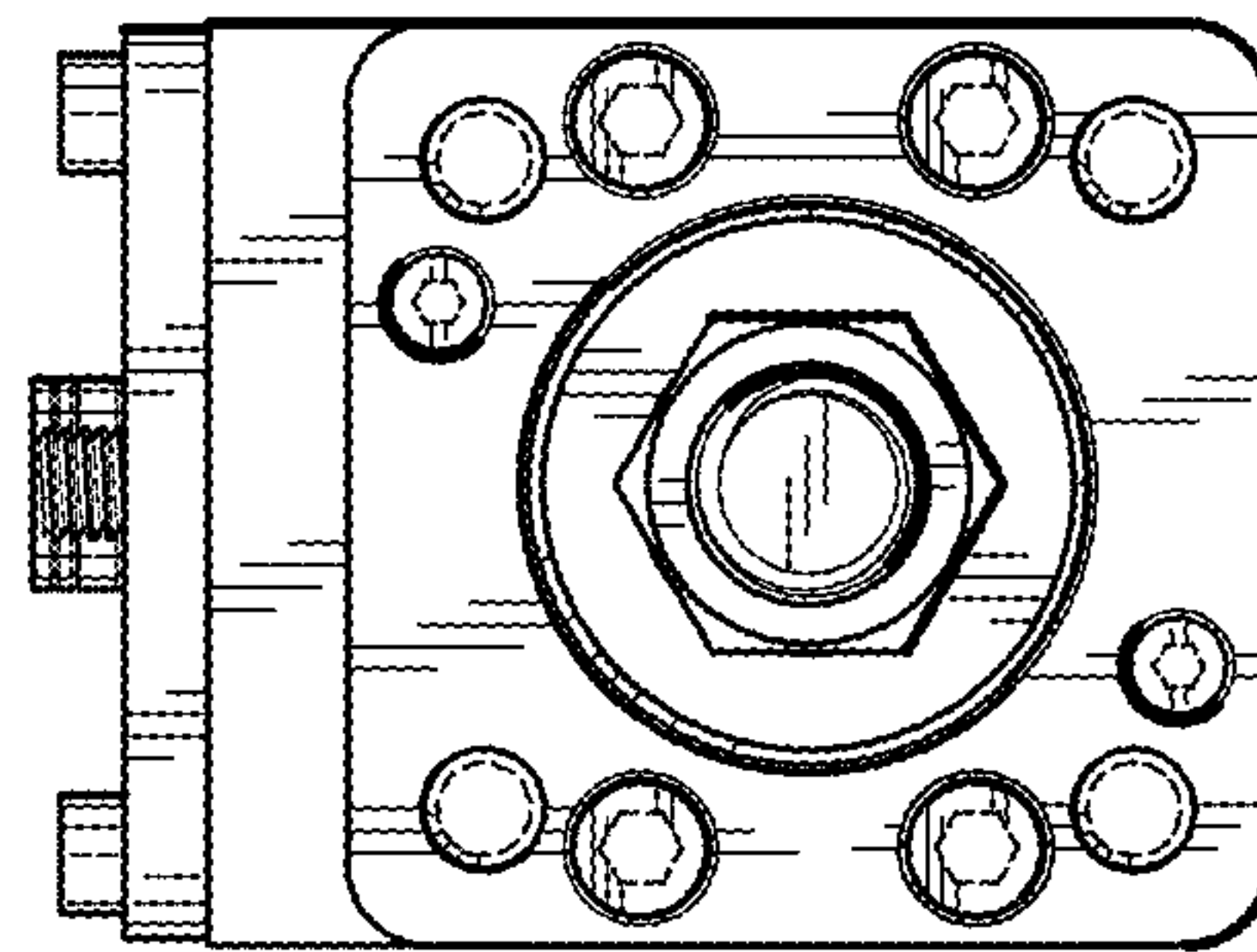

FIG. 5



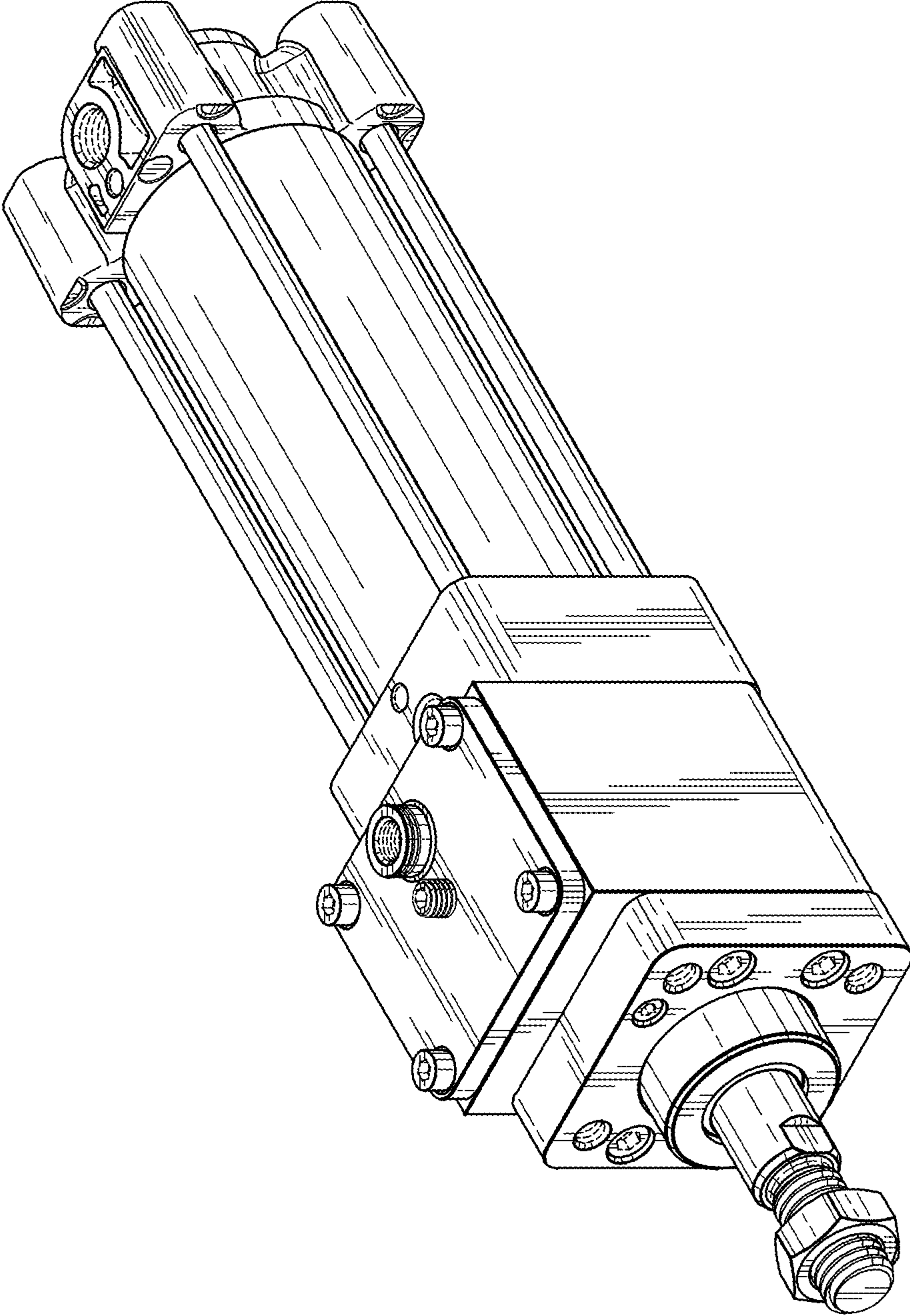

FIG. 7

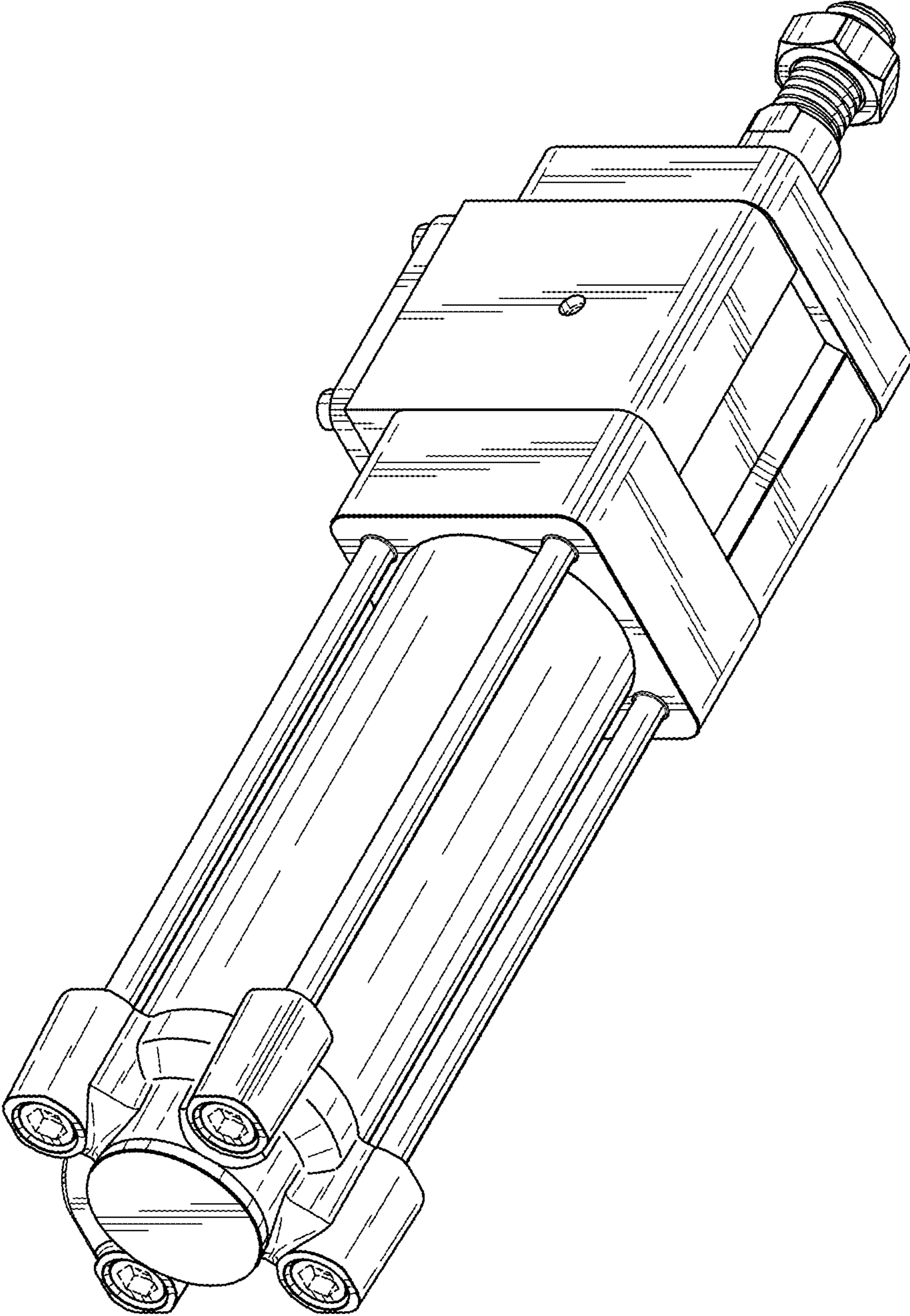

FIG. 8