



US00D900095S

(12) **United States Design Patent**  
**Wang et al.**

(10) **Patent No.:** **US D900,095 S**  
(45) **Date of Patent:** **\*\* Oct. 27, 2020**

(54) **HEAD MOUNTED DISPLAY**  
(71) Applicant: **XRSPACE CO., LTD.**, Taoyuan (TW)  
(72) Inventors: **Chieh-Kai Wang**, Taichung (TW);  
**Yen-Hung Lin**, Taoyuan (TW)  
(73) Assignee: **XRSPACE CO., LTD.**, Taoyuan (TW)  
(\*\*) Term: **15 Years**  
(21) Appl. No.: **29/696,496**

D867,362 S \* 11/2019 Chou ..... D14/372  
D872,082 S \* 1/2020 Denhez ..... D14/372  
D875,094 S \* 2/2020 Miller ..... D14/372  
D882,568 S \* 4/2020 Park ..... D14/372

**FOREIGN PATENT DOCUMENTS**

CN 303738967 7/2016  
CN 304450086 1/2018  
CN 304767768 8/2018  
CN 304848396 10/2018  
TW D196244 3/2019

\* cited by examiner

*Primary Examiner* — Austin Murphy  
(74) *Attorney, Agent, or Firm* — JCIP Global Inc.

(22) Filed: **Jun. 28, 2019**  
(51) **LOC (12) Cl.** ..... **14-02**  
(52) **U.S. Cl.**  
USPC ..... **D14/372**  
(58) **Field of Classification Search**  
USPC ..... D14/372, 496, 432, 371, 125, 126, 129,  
D14/299; D16/300–342; 351/158, 153,  
351/144; 345/7–9, 905; 455/344;  
348/115, 53, 121, 739  
CPC ..... G02B 27/017; G02B 27/0158; G02B  
27/0161; G02B 27/0181; G02B 27/0185;  
G02B 27/0189  
See application file for complete search history.

(57) **CLAIM**

The ornamental design for a head mounted display, as shown and described.

**DESCRIPTION**

FIG. 1 is a perspective view of a head mounted display showing our new design;  
FIG. 2 is another perspective view thereof;  
FIG. 3 is a front view thereof;  
FIG. 4 is a rear view thereof;  
FIG. 5 is a left side view thereof;  
FIG. 6 is a right side view thereof;  
FIG. 7 is a top view thereof; and,  
FIG. 8 is a bottom view thereof.  
The dashed broken lines illustrate portions of the head mounted display and form no part of the claimed design. The dot-dash broken line defines the boundary of the claimed design and forms no part thereof.

(56) **References Cited**

**U.S. PATENT DOCUMENTS**

D834,019 S \* 11/2018 Dallmeyer ..... D14/372  
D836,628 S \* 12/2018 Chen ..... D14/372  
D840,399 S \* 2/2019 Miller ..... D14/372  
D858,521 S \* 9/2019 Neil ..... D14/372  
D859,406 S \* 9/2019 Wei ..... D14/372  
D860,199 S \* 9/2019 McGinty, Jr. .... D14/372  
D860,200 S \* 9/2019 McGinty, Jr. .... D14/372  
D865,763 S \* 11/2019 Lau ..... D14/372  
D865,764 S \* 11/2019 Miller ..... D14/372

**1 Claim, 8 Drawing Sheets**

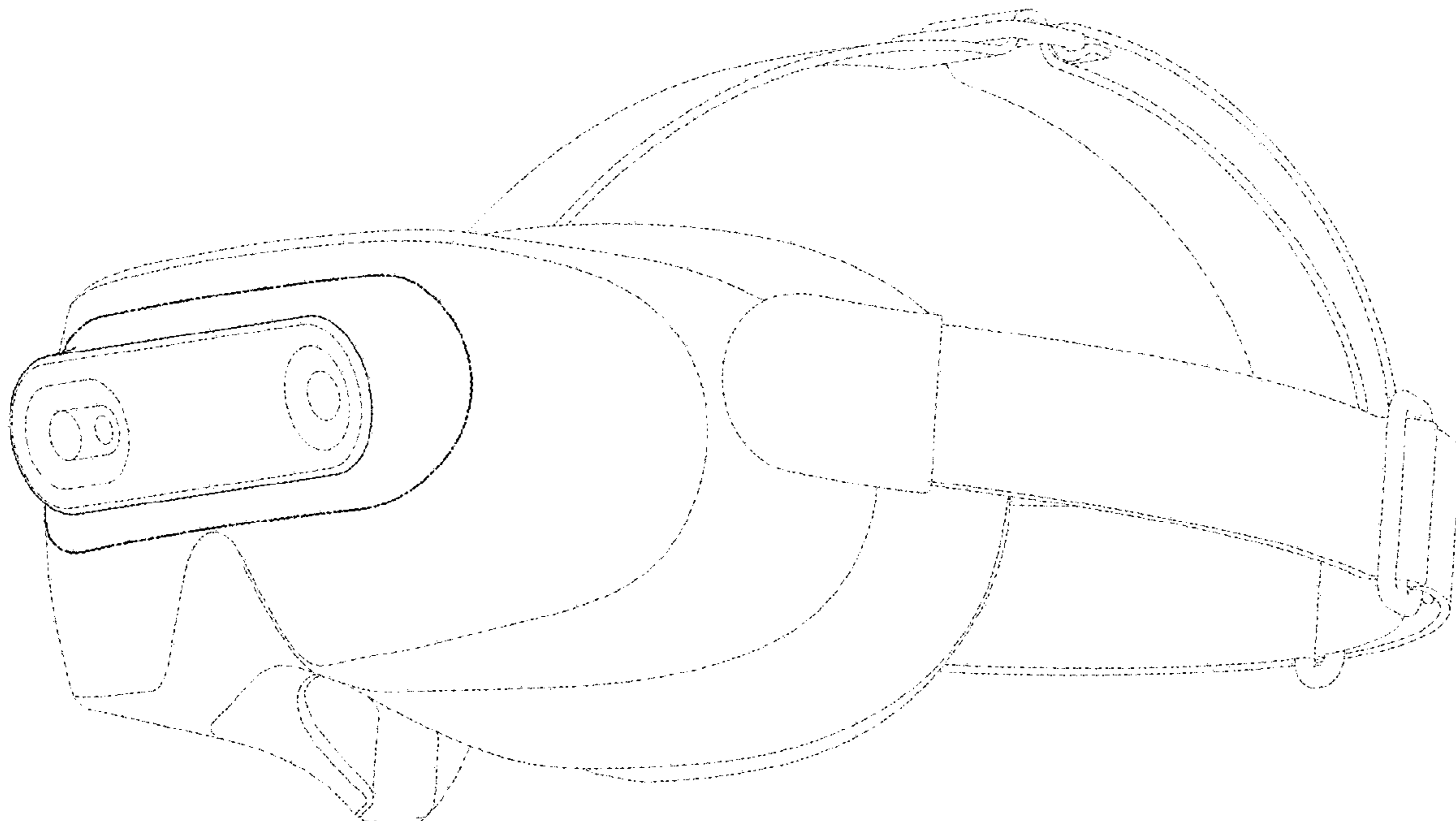

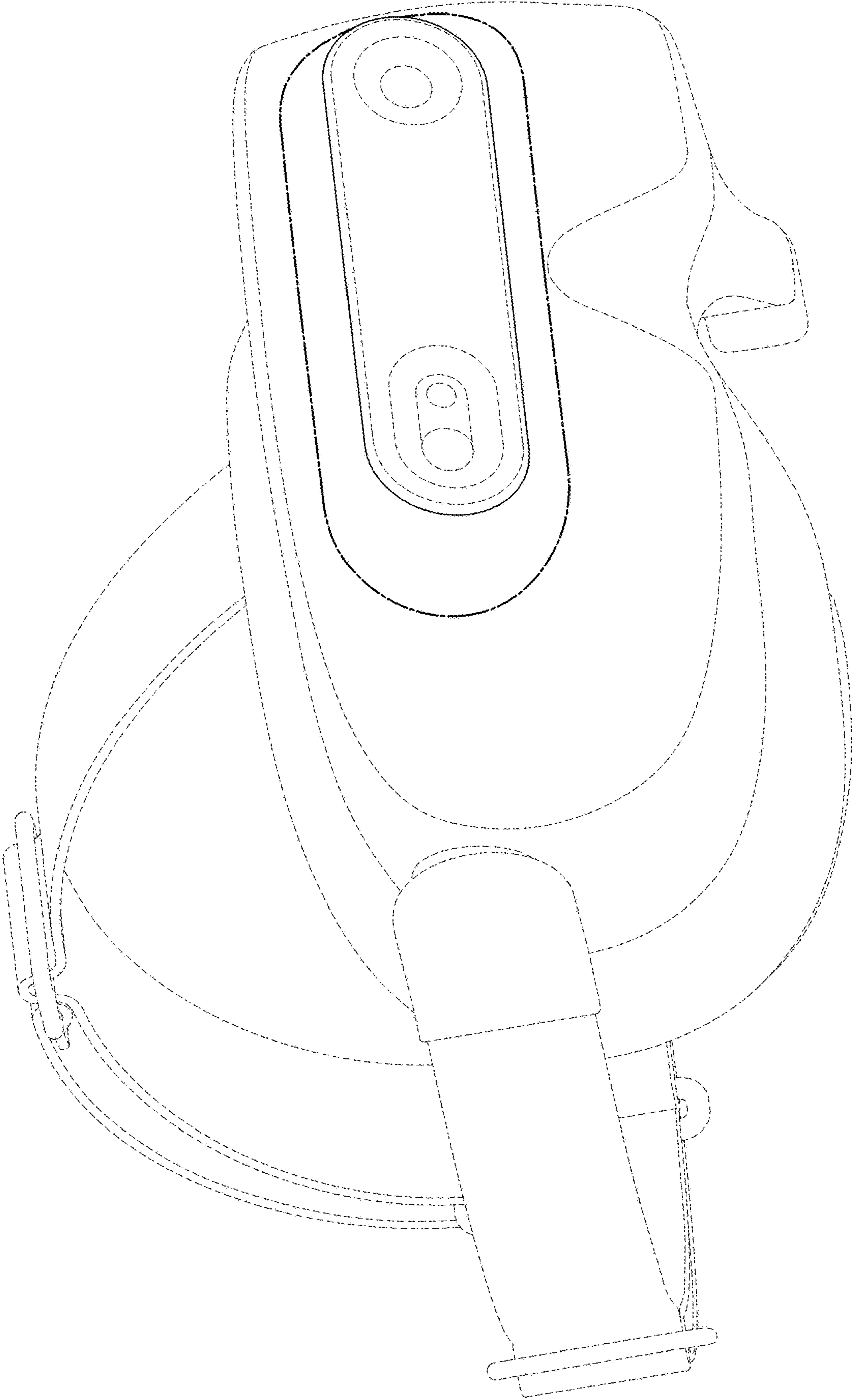

FIG. 1

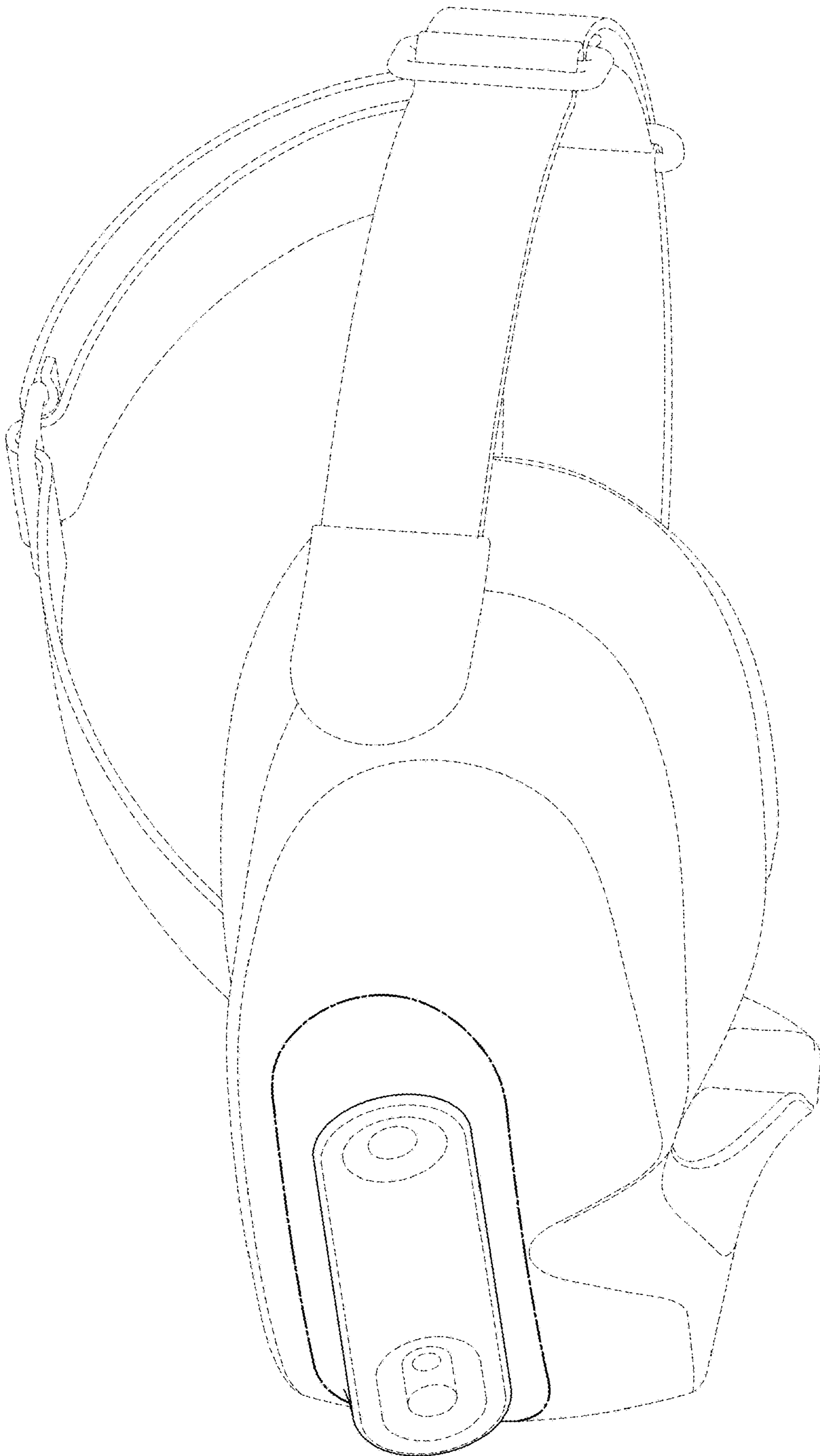

FIG. 2

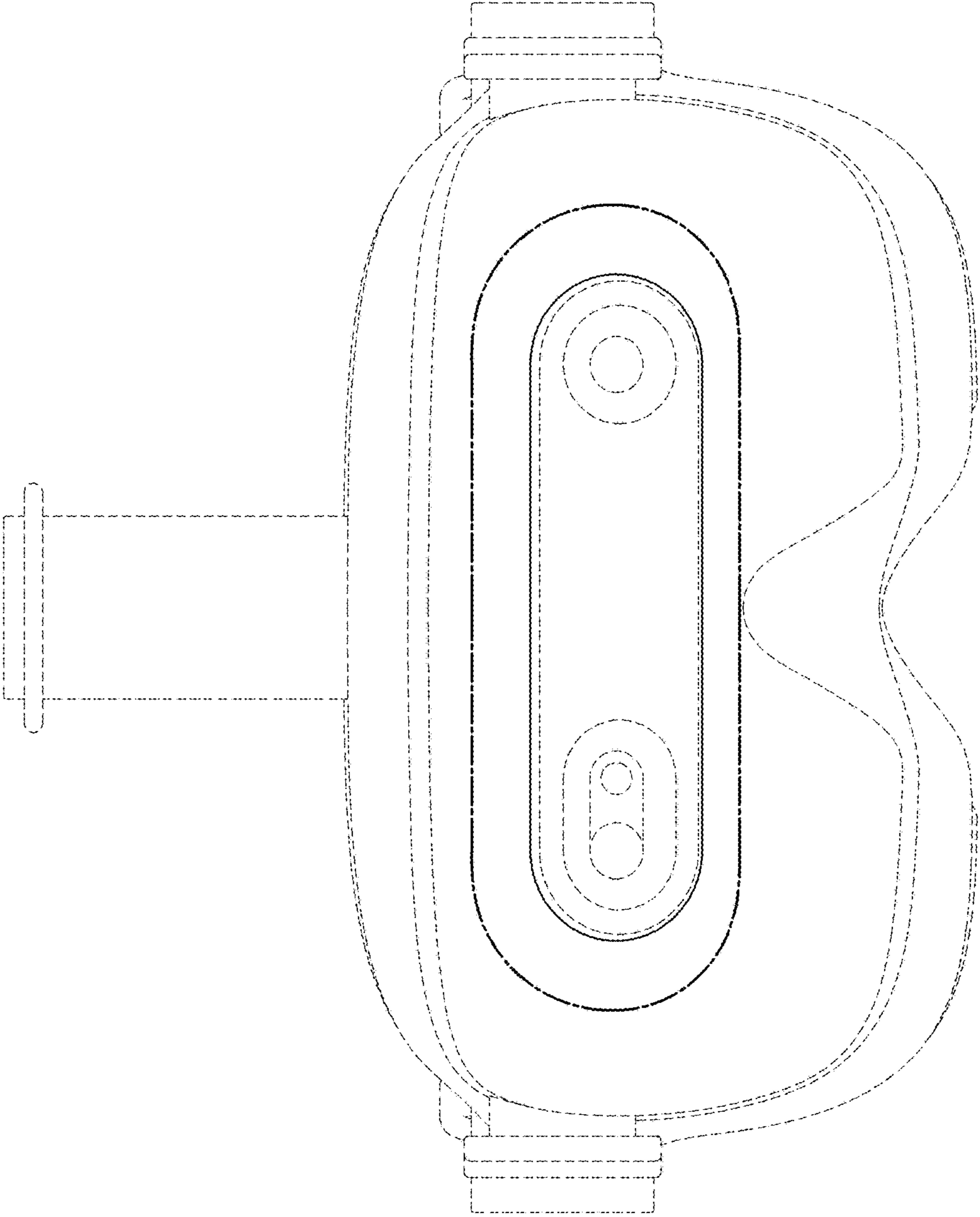

FIG. 3

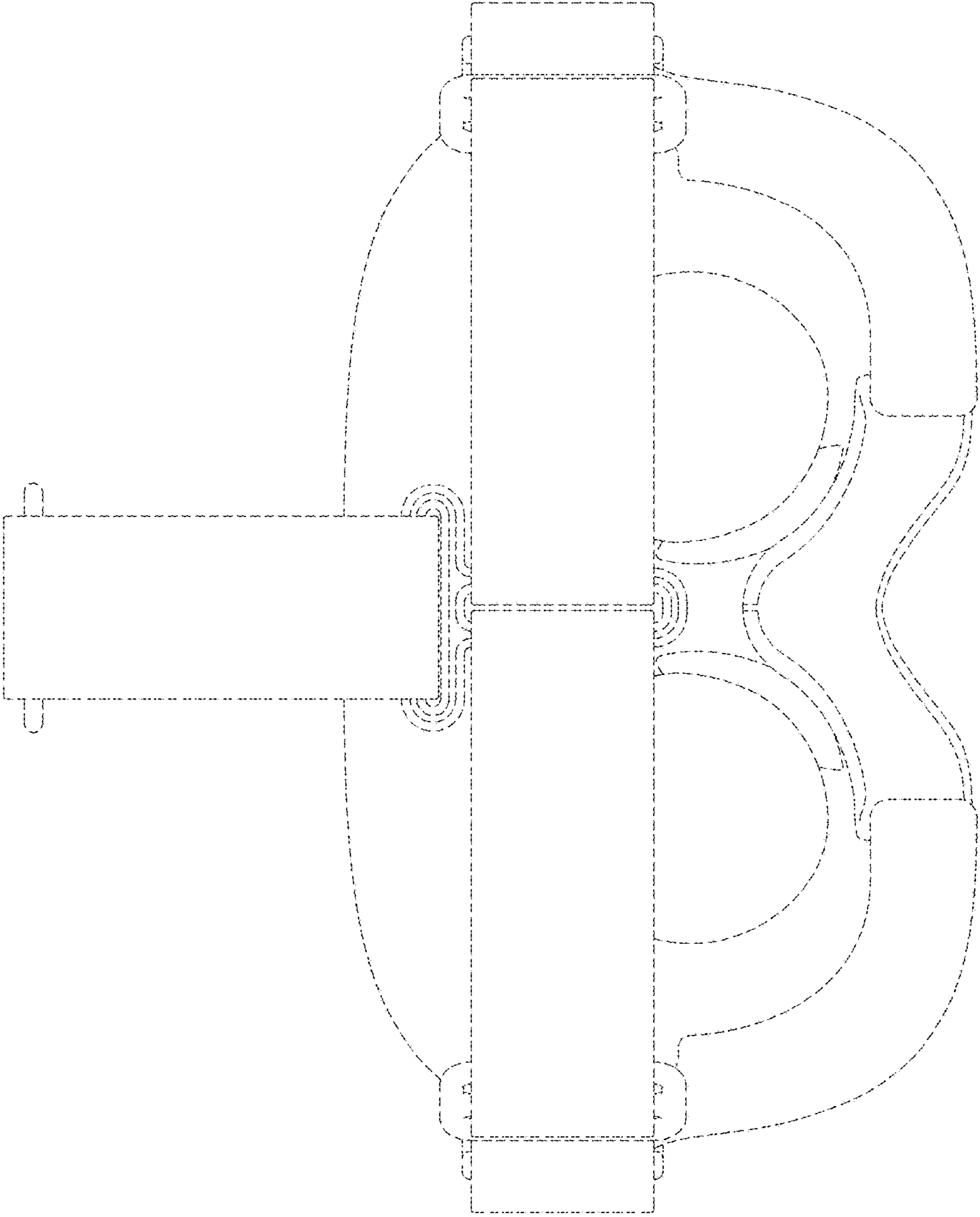

FIG. 4



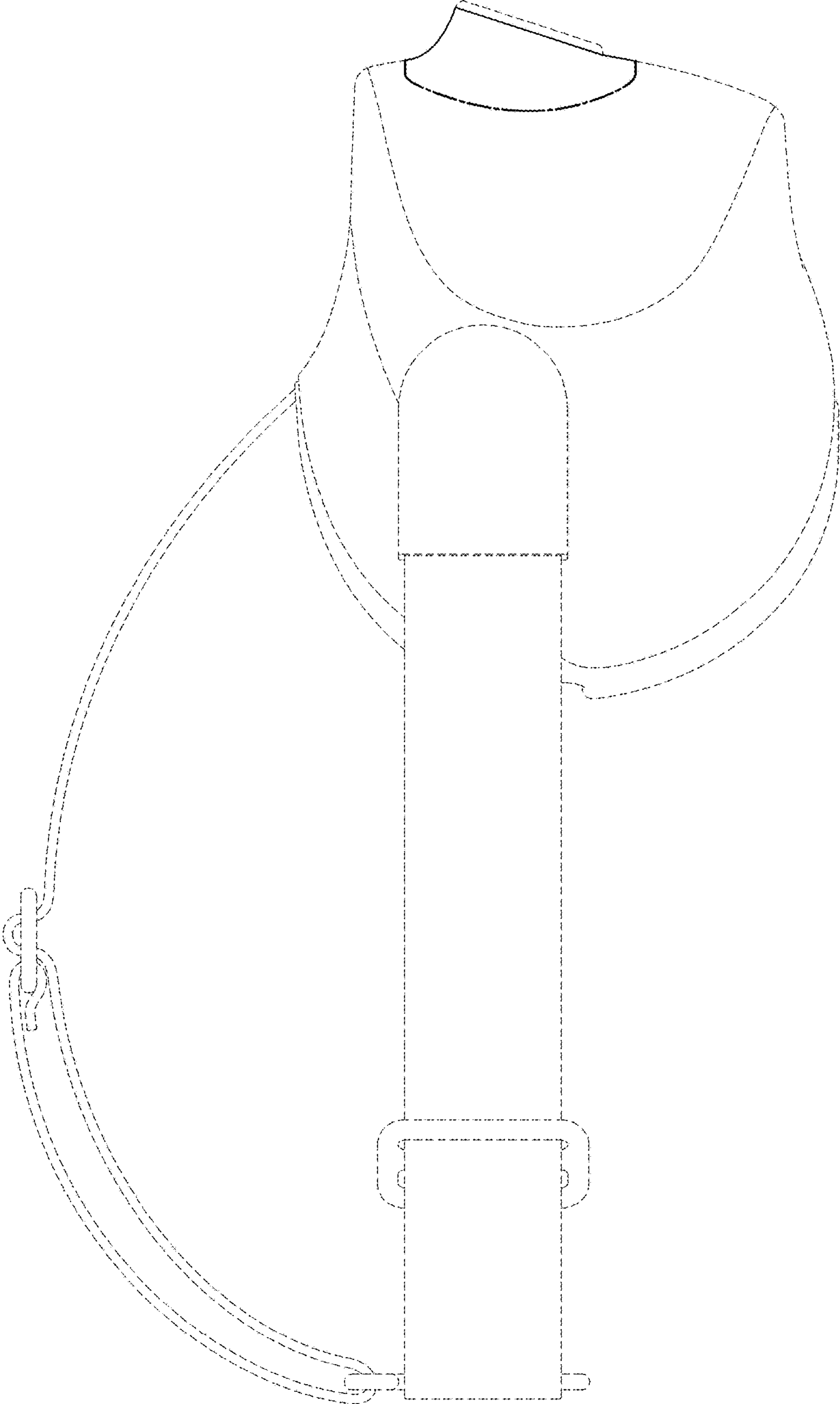

FIG. 5

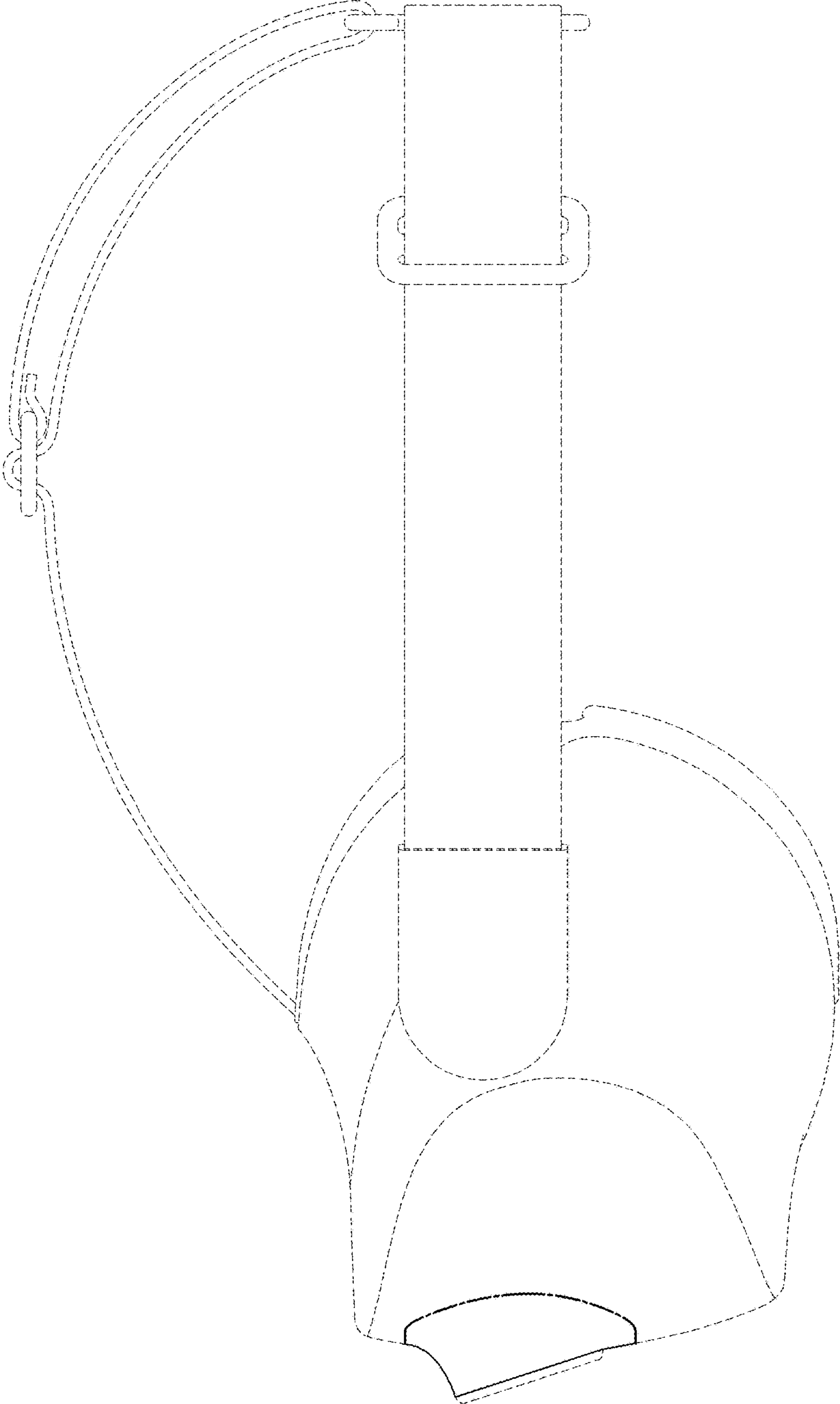

FIG. 6

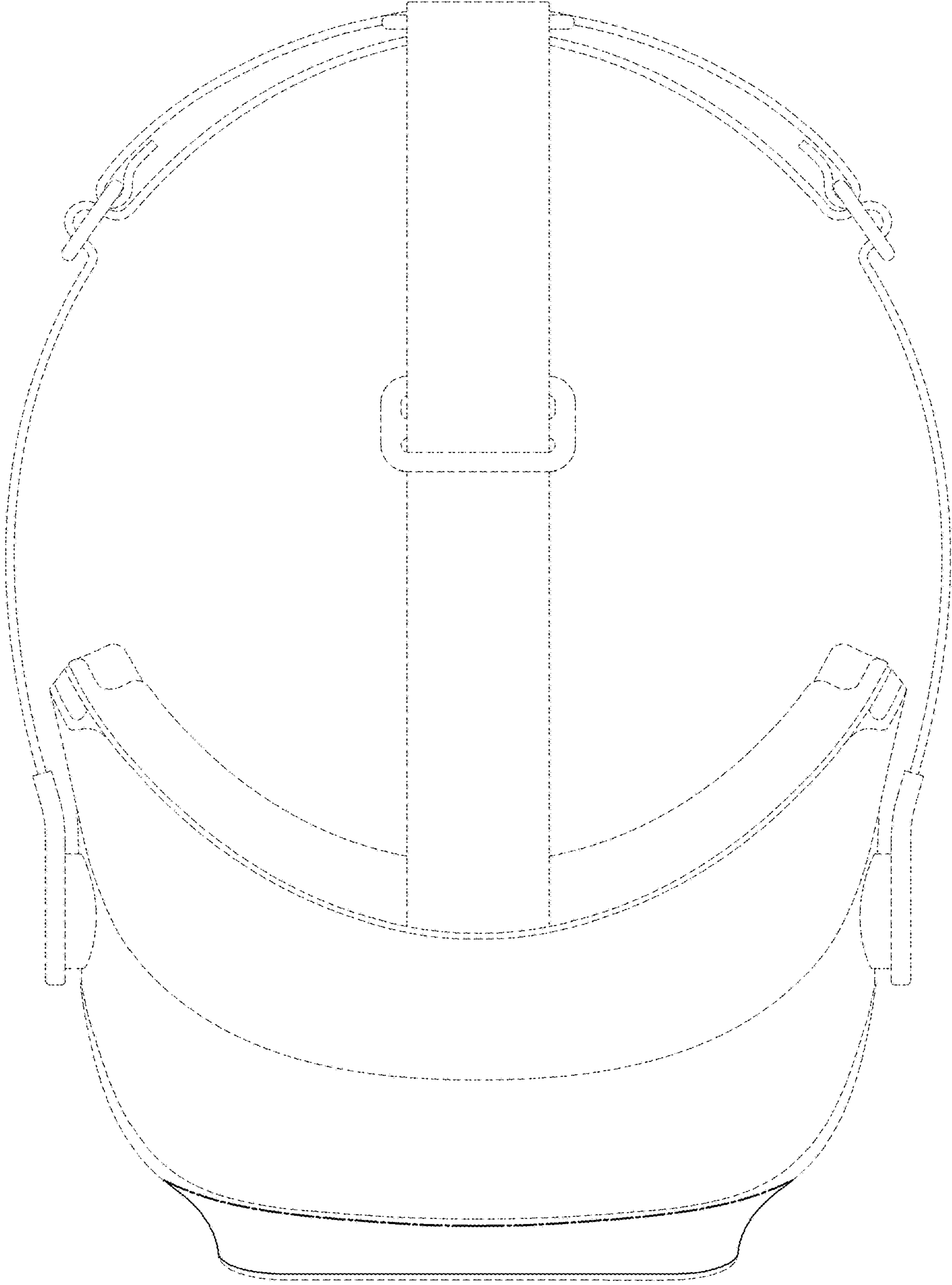

FIG. 7



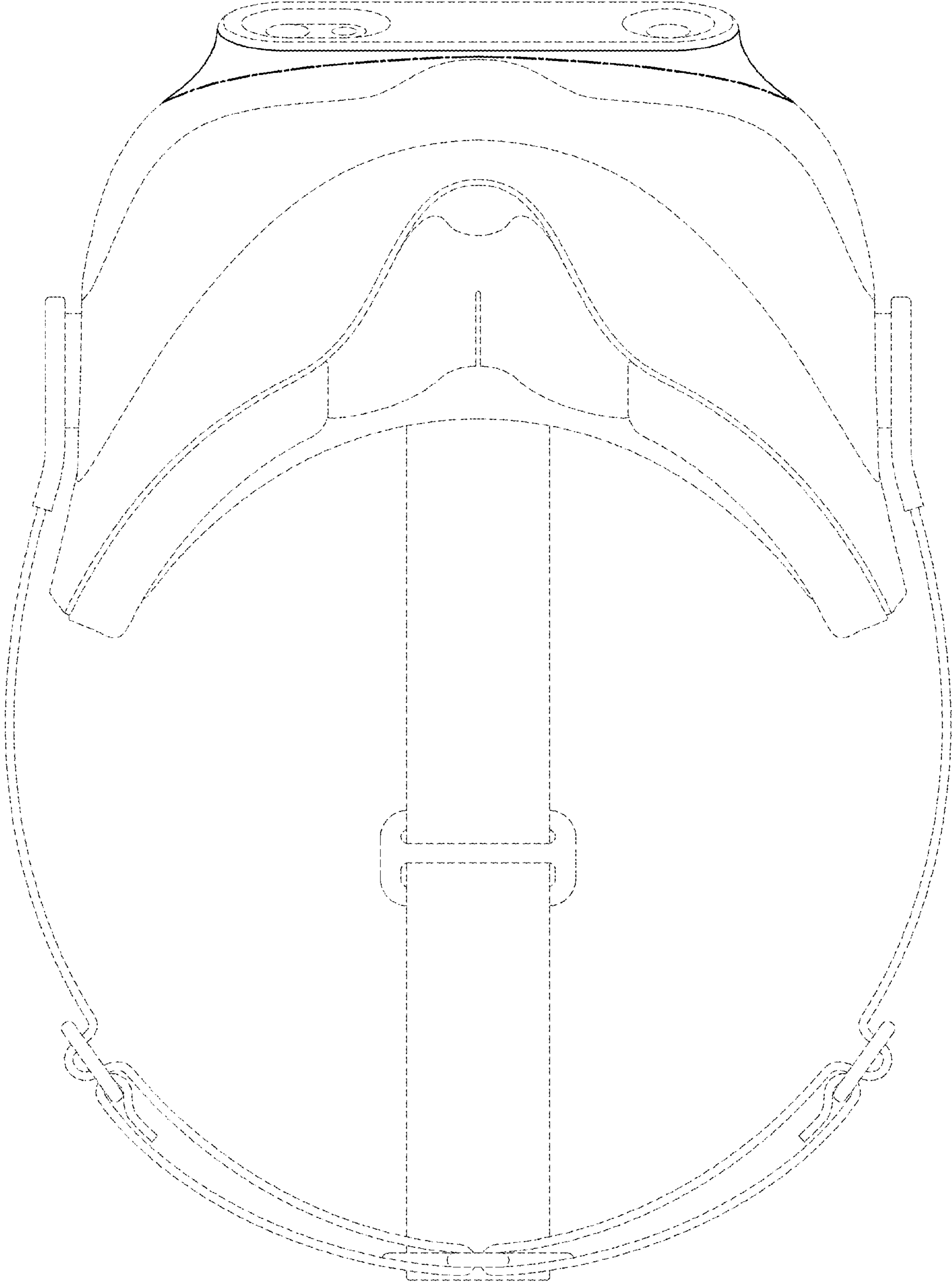

FIG. 8