



US00D900082S

(12) **United States Design Patent**
Kim

(10) **Patent No.:** **US D900,082 S**

(45) **Date of Patent:** **** *Oct. 27, 2020**

- (54) **CASE FOR ELECTRONIC COMMUNICATIONS DEVICE**
- (71) Applicant: **SPIGEN KOREA CO., LTD.**, Seoul (KR)
- (72) Inventor: **Seungjoo Kim**, Seoul (KR)
- (73) Assignee: **Spigen Korea CO., LTD.**, Seoul (KR)
- (*) Notice: This patent is subject to a terminal disclaimer.
- (**) Term: **15 Years**
- (21) Appl. No.: **29/691,194**
- (22) Filed: **May 14, 2019**

Related U.S. Application Data

- (63) Continuation of application No. 29/614,404, filed on Aug. 18, 2017, now Pat. No. Des. 852,180.
- (51) **LOC (12) Cl.** **14-03**
- (52) **U.S. Cl.**
USPC **D14/250**
- (58) **Field of Classification Search**
USPC D14/250, 203.3-203.7, 439, 238.1, 440, D14/251-253, 447, 217, 240, 248; D3/201, 218, 247, 269, 273, 301, 303; D13/103, 119, 107-108
CPC H04B 1/3888; H04M 1/0283; H04M 1/0202; A45C 1/06; A45C 11/00; A45C 13/02; A45C 2011/002; A45F 2005/026; A45F 2200/0525; A45F 2200/0516
See application file for complete search history.

D609,672 S *	2/2010	Lee	D14/138 AA
D615,077 S	5/2010	Richardson et al.		
D615,536 S	5/2010	Richardson et al.		
D623,639 S	9/2010	Richardson et al.		
D623,640 S	9/2010	Freeman		
D640,246 S *	6/2011	Liu	D14/248
D643,029 S	8/2011	Feng		
D643,837 S	8/2011	Smith		
7,989,085 B2 *	8/2011	Li	H04M 1/0283 174/50
D646,265 S *	10/2011	Fathollahi	D14/250
D647,084 S *	10/2011	Fathollahi	D14/250
D651,202 S	12/2011	Fathollahi		
D662,929 S	7/2012	Fahrendorff et al.		
D666,604 S *	9/2012	Li	D14/248
D669,889 S	10/2012	Li et al.		
D671,930 S	12/2012	Akana et al.		
D673,539 S	1/2013	Magness et al.		
D674,789 S	1/2013	Wen		
D679,695 S	4/2013	Fahrendorff et al.		
D679,698 S	4/2013	Murchison et al.		
D681,615 S *	5/2013	Fathollahi	D14/250
D681,617 S *	5/2013	Weller	D14/250
D687,027 S	7/2013	Melanson et al.		
D691,122 S	10/2013	Bau		
D691,601 S	10/2013	Murchison et al.		
D694,224 S	11/2013	Wooseung		
D694,759 S	12/2013	Chang et al.		
D696,238 S	12/2013	Murchison et al.		
D696,240 S	12/2013	Kim et al.		
D698,776 S *	2/2014	Fathollahi	D14/250
D703,646 S *	4/2014	Fathollahi	D14/250
D703,653 S	4/2014	Brubaker et al.		
D703,656 S	4/2014	Witter et al.		
D716,783 S *	11/2014	Loncar	D14/250
D721,071 S	1/2015	Nelson et al.		
D721,686 S	1/2015	Jacob et al.		
D721,693 S	1/2015	Lee et al.		
D732,525 S	6/2015	Seo et al.		
D734,747 S	7/2015	Seo et al.		
D735,182 S	7/2015	Watkins et al.		
D739,394 S	9/2015	Rayner et al.		
D741,845 S	10/2015	Kim		
D746,805 S	1/2016	Kim		
9,264,089 B2 *	2/2016	Tages	H04B 1/3888
D751,058 S *	3/2016	Cocchia	D14/250
D756,343 S	5/2016	Wall et al.		
D763,241 S	8/2016	Kim		
D765,627 S	9/2016	Watt		
D765,633 S	9/2016	Northrup et al.		
D765,638 S	9/2016	Gaylord et al.		
D765,644 S	9/2016	Witter et al.		
D765,645 S	9/2016	Kim		

(56) **References Cited**

U.S. PATENT DOCUMENTS

D111,093 S *	8/1938	Turpan	D5/47
D515,809 S *	2/2006	Perella	D3/232
D574,819 S	8/2008	Andre et al.		
D599,788 S *	9/2009	Nuovo	D14/248
D607,860 S *	1/2010	Bae	D14/138 AA

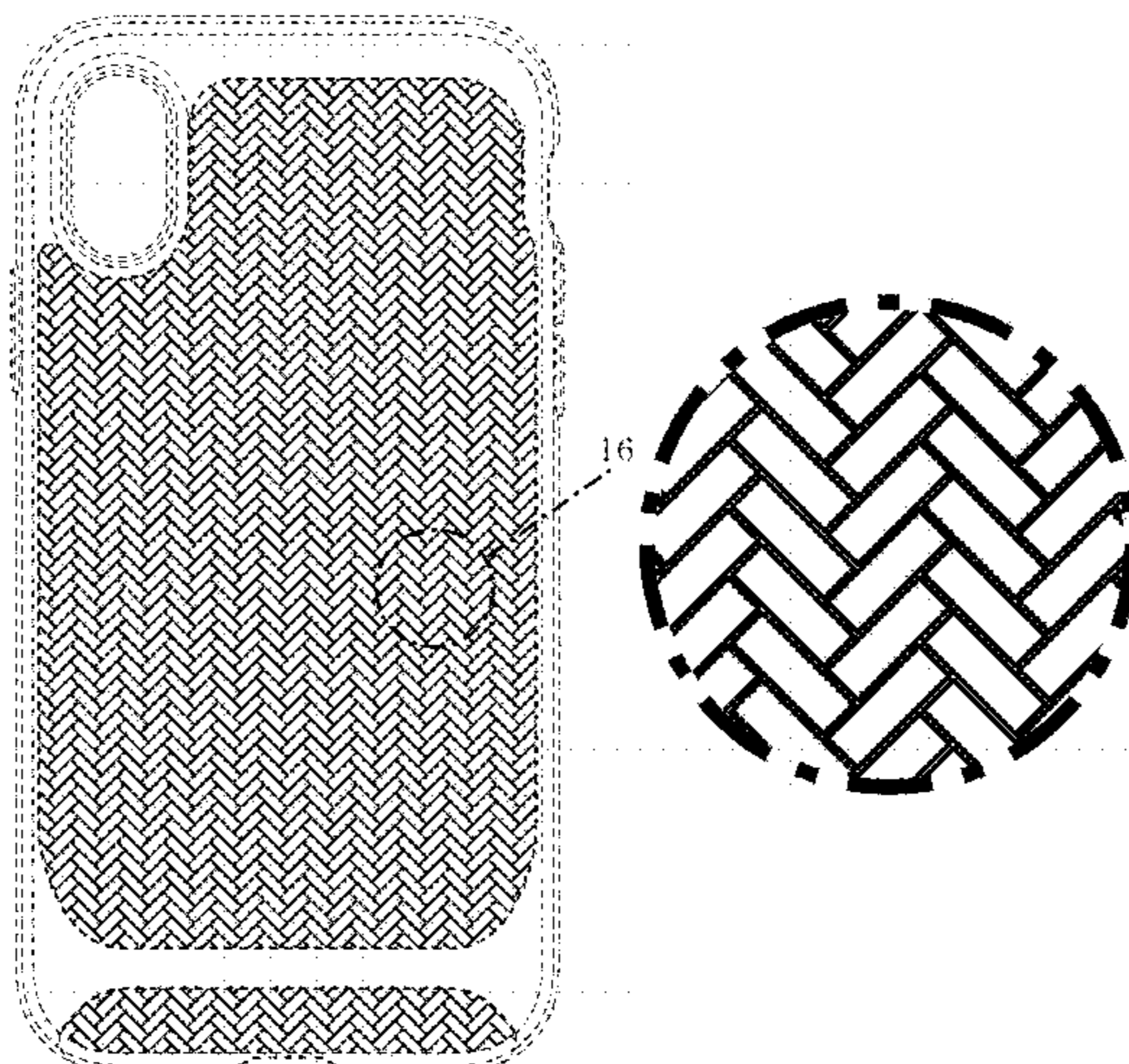

D766,819	S	*	9/2016	Gjovik	D13/103
D767,554	S		9/2016	Bertrand et al.	
D771,612	S		11/2016	Roberts et al.	
D771,613	S		11/2016	Poon et al.	
D772,211	S		11/2016	Poon et al.	
D773,445	S		12/2016	Witter et al.	
D774,499	S	*	12/2016	Fathollahi	D14/250
D776,647	S		1/2017	Kim	
D777,157	S		1/2017	Kim	
D777,159	S		1/2017	Lee et al.	
D778,271	S		2/2017	Stump et al.	
D781,835	S		3/2017	Kim et al.	
D781,836	S		3/2017	Kim et al.	
D781,837	S		3/2017	Kim et al.	
D781,838	S		3/2017	Kim et al.	
D781,839	S		3/2017	Kim et al.	
D781,840	S		3/2017	Kim et al.	
D782,453	S		3/2017	Kim et al.	
D782,454	S		3/2017	Kim et al.	
D782,460	S		3/2017	Bertrand et al.	
D784,309	S		4/2017	Lee et al.	
D786,848	S		5/2017	Park et al.	
D786,849	S		5/2017	Park et al.	
D786,853	S		5/2017	Friedland et al.	
D792,394	S		7/2017	Lee et al.	
D795,237	S		8/2017	Jung et al.	
D797,715	S		9/2017	Kim	
D800,714	S		10/2017	Lee et al.	
D801,323	S		10/2017	Kim	
D808,372	S		1/2018	Brown et al.	
D834,581	S		1/2018	Li	
D836,095	S		12/2018	Kim et al.	
D839,860	S	*	2/2019	Kim	D14/250
D840,990	S		2/2019	Kim	
D840,991	S		2/2019	Kim	
D845,290	S		4/2019	Brubaker et al.	
D848,997	S	*	5/2019	Kim	D14/250
D851,638	S		6/2019	Kim et al.	
D851,639	S	*	6/2019	Kim	D14/250
D852,180	S	*	6/2019	Kim	D14/250
D857,683	S	*	8/2019	Kim	D14/250
D863,279	S	*	10/2019	Kim	D14/250

OTHER PUBLICATIONS

Spigen, “Installation video of SGP Neo Hybrid Case”, <https://www.youtube.com/watch?v=mVASro4MsEg>, Published on Oct. 30, 2009, Downloaded on Feb. 21, 2019.

Spigen, “Installation video of SGP Neo Hybrid2”, https://www.youtube.com/watch?v=y5_NdOVOfZo, Published on May 25, 2010, Downloaded on Feb. 21, 2019.

Spigen, “Installation video of SGP Neo Hybrid EX on iPhone 4”, <https://www.youtube.com/watch?v=Z-IRD1H1w0E>, Published on Sep. 3, 2010, Downloaded on Feb. 21, 2019.

“SGP iPhone 4 Case Neo Hybrid Matte Series Gun Metal”, https://www.amazon.co.uk/iPhone-Case-Hybrid-Matte-Metal/dp/B004F1IQ7E/ref=cm_cr_srp_d_product_top?ie=UTF8, Earliest review date of Dec. 3, 2010, Downloaded on Aug. 15, 2018.

Spigen, “Installation video of SGP Case Neo Hybrid EX on Galaxy S2”, <https://www.youtube.com/watch?v=ZPhSIAUxXWg>, Published on Aug. 24, 2011, Downloaded on Feb. 21, 2019.

Danny Winget, “Spigen SGP Neo Hybrid for Galaxy Noe 3 Review”, <https://www.youtube.com/watch?v=W80JtBDSckk>, Published on Nov. 3, 2013, Downloaded on Dec. 20, 2018.

“Spigen Neo Hybrid Galaxy S5 Case with Flexible Inner Protection and Reinforced Hard Bumper Frame for Samsung Galaxy S5 2014—Electric Blue”, <https://www.amazon.com/dp/B0013UWJYJ>, Earliest review date of Apr. 12, 2014, Downloaded on Jan. 22, 2019.

“Spigen Neo Hybrid iPhone 6 Case with Flexible Inner Protection and Reinforced Hard Bumper Frame for iPhone 6S / iPhone 6—Gunmetal”, <https://www.amazon.com/dp/B00LL6ZPXY>, Earliest review date of Aug. 28, 2014, Downloaded on Dec. 18, 2019.

“Spigen Neo Hybrid EX iPhone 6 Case with Flexible Inner Bumper and Reinforced Hard Frame for iPhone 6S/iPhone 6—EX Satin Silver”, <https://www.amazon.com/dp/B00LL6RZ3C>, Earliest review date of Sep. 6, 2014, Downloaded on Dec. 18, 2019.

“Spigen Neo Hybrid Nexus 6 Case with Flexible Inner Protection and Reinforced Hard Bumper Frame for Google Nexus 6 2014—Dante Red”, <https://www.amazon.com/dp/B00OH4HKGC>, Earliest review date of Nov. 16, 2014, Downloaded on Dec. 18, 2019.

“Spigen Neo Hybrid Galaxy S6 Case with Flexible Inner Protection and Reinforced Hard Bumper Frame for Galaxy S6 2015—Satin Silver”, <https://www.amazon.com/dp/B00QU4Q31A>, Earliest review date of Mar. 6, 2015, Downloaded on Dec. 18, 2019.

“Spigen Neo Hybrid Galaxy S6 Edge Case with Flexible Inner Protection and Reinforced Hard Bumper Frame for Galaxy S6 Edge 2015—Gunmetal”, <https://www.amazon.com/dp/B00SV635BG>, Earliest review date of Mar. 19, 2015, Downloaded on Dec. 18, 2019.

“Spigen Neo Hybrid CC Galaxy S6 Case with Flexible Inner Casing and Reinforced Hard Bumper Frame for Galaxy S6 2015—Satin Silver”, <https://www.amazon.com/dp/B00UMDOZLU>, Earliest review date of Mar. 25, 2015, Downloaded on Dec. 18, 2019.

“Spigen Neo Hybrid CC Galaxy S6 Edge Case with Flexible Inner Casing and Reinforced Hard Bumper Frame for Galaxy S6 Edge 2015—Blue Topaz”, <https://www.amazon.com/dp/B00USAPGKQ>, Earliest review date of Apr. 4, 2015, Downloaded on Dec. 18, 2019.

“Spigen Neo Hybrid Carbon Galaxy S6 Edge Plus Case with Carbon Fiber Design and Reinforced Hard Bumper Frame for Galaxy S6 Edge Plus 2015—Dante Red”, <https://www.amazon.com/dp/B010MWHZS0>, Earliest review date of Aug. 18, 2015, Downloaded on Dec. 18, 2019.

“Spigen Neo Hybrid Crystal Galaxy Note 5 Case with Flexible Inner Casing and Reinforced Hard Bumper Frame for Galaxy Note 5 2015—Champagne Gold”, <https://www.amazon.com/dp/B010MWIG1K>, Earliest review date of Aug. 22, 2015, Downloaded on Dec. 18, 2019.

“iPhone 6s Case, Spigen [Neo Hybrid EX] Premium Bumper [Rose Gold] Clear TPU / PC Frame Slim Dual Layer Premium Case for iPhone 6 (2014) / 6s (2015)—Rose, Gold (SGP11725)”, <https://www.amazon.com/dp/B012PKV30S>, Earliest review date of Aug. 28, 2015, Downloaded on Dec. 18, 2019.

“Spigen Neo Hybrid Carbon iPhone 6s Case with Carbon Fiber Design and Reinforced Hard Bumper Frame for Apple iPhone 6s / iPhone 6 (2015)—Reventon Yellow”, <https://www.amazon.com/dp/B010MVJ5O8>, Earliest review date of Sep. 1, 2015, Downloaded on Dec. 18, 2019.

“Spigen Neo Hybrid iPhone 6S Case with Flexible Inner Protection and Reinforced Hard Bumper Frame for iPhone 6S 2015—Gunmetal”, <https://www.amazon.com/dp/B010MVIZTE>, Earliest review date of Sep. 1, 2015, Downloaded on Dec. 18, 2019.

“Spigen Neo Hybrid EX iPhone 6S Plus Case with Flexible Inner Bumper and Reinforced Hard Frame for iPhone 6S Plus/iPhone 6 Plus—Champagne Gold”, <https://www.amazon.com/dp/B010MVR16>, Earliest review date of Sep. 4, 2015, Downloaded on Dec. 18, 2019.

“Spigen Neo Hybrid Crystal Galaxy S7 Edge Case with Flexible Inner Casing and Reinforced Hard Bumper Frame for Samsung Galaxy S7 Edge 2016—Satin Silver”, <https://www.amazon.com/dp/B01A7IDQV4>, Earliest review date of Feb. 22, 2016, Downloaded on Dec. 18, 2019.

“Spigen Neo Hybrid Galaxy S7 Case with Flexible Inner Protection and Reinforced Hard Bumper Frame for Samsung Galaxy S7 2016—Gunmetal”, <https://www.amazon.com/dp/B01B116J0E>, Earliest review date of Feb. 27, 2016, Downloaded on Dec. 18, 2019.

“Spigen Neo Hybrid Galaxy S7 Edge Case with Flexible Inner Protection and Reinforced Hard Bumper Frame for Samsung Galaxy S7 Edge 2016—Satin Silver”, <https://www.amazon.com/dp/B01B116JMM>, Earliest review date of Feb. 27, 2016, Downloaded on Dec. 18, 2019.

“Spigen Neo Hybrid Crystal Galaxy S7 Case with Flexible Inner Casing and Reinforced Hard Bumper Frame for Samsung Galaxy S7 2016—Champagne Gold”, <https://www.amazon.com/dp/B01B29WCOY>, Earliest review date of Mar. 3, 2016 Downloaded on Dec. 18, 2019.

“Spigen Neo Hybrid iPhone SE Case with Flexible Inner Protection and Reinforced Hard Bumper Frame for iPhone SE 2016—Gunmetal”, <https://www.amazon.com/dp/B01BEJBBSK>, Earliest review date of Apr. 6, 2016, Downloaded on Dec. 18, 2019.

“Spigen Neo Hybrid Crystal iPhone SE Case with Flexible Inner Casing and Reinforced Hard Bumper Frame for iPhone SE 2016—Rose Gold”, <https://www.amazon.com/dp/B01BEJB7TI>, Earliest review date of Apr. 7, 2016, Downloaded on Dec. 18, 2019.

“Spigen Neo Hybrid Crystal LG G5 Case with Flexible Inner Casing and Reinforced Hard Bumper Frame for LG G5 2016—Champagne Gold”, <https://www.amazon.com/dp/B01B1GQKIC>, Earliest review date of Apr. 17, 2016, Downloaded on Dec. 18, 2019.

“Spigen Neo Hybrid OnePlus 3 Case/OnePlus 3T Case with Flexible Inner Protection and Reinforced Hard Bumper Frame for OnePlus 3 2016—Gunmetal”, <https://www.amazon.com/dp/B01H3PF76Q>, Earliest review date of Aug. 9, 2016, Downloaded on Dec. 18, 2019.

“Spigen Neo Hybrid Crystal iPhone 7 Plus Case with Flexible Casing and Hard Bumper Frame for Apple iPhone 7 Plus 2016—Champagne Gold”, <https://www.amazon.com/dp/B01GIWHKXI>, Earliest review date of Sep. 8, 2016, Downloaded on Dec. 18, 2019.

“Spigen Neo Hybrid iPhone 7 Case with Flexible Inner Protection and Reinforced Hard Bumper Frame for iPhone 7 2016—Gunmetal”, <https://www.amazon.com/dp/B01GIVXKUG>, Earliest review date of Sep. 8, 2016, Downloaded on Dec. 18, 2019.

“Spigen Neo Hybrid Crystal iPhone 7 Case with Flexible Inner Casing and Reinforced Hard Bumper Frame for iPhone 7 2016—Rose”, <https://www.amazon.com/dp/B01GIVXVN2>, Earliest review date of Sep. 14, 2016, Downloaded on Dec. 18, 2019.

“Spigen Neo Hybrid iPhone 7 Plus Case with Flexible Inner Protection and Hard Bumper Frame for Apple iPhone 7 Plus (2016)—Gunmetal”, <https://www.amazon.com/dp/B01GIWH6H8>, Earliest review date of Sep. 14, 2016, Downloaded on Dec. 18, 2019.

“Spigen Neo Hybrid Google Pixel XL Case with Flexible Inner Protection and Reinforced Hard Bumper Frame for Google Pixel XL 2016—Satin Silver”, <https://www.amazon.com/dp/B01LZW1LW3>, Earliest review date of Oct. 23, 2016, Downloaded on Dec. 18, 2019.

“Spigen Neo Hybrid Google Pixel Case with Flexible Inner Protection and Reinforced Hard Bumper Frame for Google Pixel 2016—Blue”, <https://www.amazon.com/dp/B01N3VR9EA>, Earliest review date of Jan. 10, 2017, Downloaded on Dec. 18, 2019.

“Spigen Neo Hybrid Huawei Y6 Case with Flexible Inner Protection and Reinforced Hard Bumper Frame for Huawei Y6 2015—Champagne Gold”, <https://www.amazon.com/dp/B0182SKWUO>, Earliest review date of Feb. 13, 2017, Downloaded on Dec. 18, 2019.

“Spigen Neo Hybrid Crystal Glitter Galaxy S8 Case with Flexible Inner Casing and Reinforced Hard Bumper Frame for Samsung Galaxy S8 (2017)—Space Quartz”, <https://www.amazon.com/dp/B06XP5KTXN>, Earliest review date of Apr. 15, 2017, Downloaded on Dec. 18, 2019.

“Spigen Neo Hybrid Crystal Galaxy S8 Plus Case with Clear Hard Casing and Reinforced Hard Bumper Frame for Galaxy S8 Plus (2017)—Gunmetal”, <https://www.amazon.com/dp/B06XP5HHV1>, Earliest review date of Apr. 20, 2017, Downloaded on Dec. 18, 2019.

“Spigen Neo Hybrid Crystal Glitter Galaxy S8 Plus Case with Flexible Inner Protection and Reinforced Hard Bumper Frame for Galaxy S8 Plus (2017)—Space Quartz”, <https://www.amazon.com/dp/B06XNW4WS9>, Earliest review date of Apr. 20, 2017, Downloaded on Dec. 18, 2019.

“Spigen Neo Hybrid Crystal Galaxy S6 Edge Plus Case with Flexible Inner Casing and Reinforced Hard Bumper Frame for Galaxy S6 Edge Plus 2015—Blue Topaz”, <https://www.amazon.com/dp/B010MWIIXQ>, Earliest review date of Jun. 25, 2017, Downloaded on Dec. 18, 2019.

“Spigen Neo Hybrid OnePlus 5 Case with Flexible Inner Protection and Reinforced Hard Bumper Frame for OnePlus 5 (2017)—Gunmetal”, <https://www.amazon.com/dp/B06XG24Q98>, Earliest review date of Aug. 23, 2017, Downloaded on Dec. 18, 2019.

“Spigen Neo Hybrid Crystal Galaxy Note 8 Case with Clear Hard Casing and Reinforced Hard Bumper Frame for Galaxy Note 8 (2017)—Gunmetal”, <https://www.amazon.com/dp/B073R79115>, Earliest review date of Aug. 28, 2017, Downloaded on Dec. 18, 2019, Downloaded on Dec. 18, 2019.

“Spigen Neo Hybrid Herringbone iPhone 8 Plus Case/iPhone 7 Plus Case with Hard Bumper Frame for Apple iPhone 8 Plus (2017) / Apple iPhone 7 Plus (2016)—Black & Gunmetal”, <https://www.amazon.com/dp/B07482D1JW>, Earliest review date of Sep. 12, 2017, Downloaded on Dec. 18, 2019.

“Spigen Neo Hybrid [2nd Generation] iPhone 8 Plus Case/iPhone 7 Plus Case with Hard Frame for Apple iPhone 8 Plus (2017) / Apple iPhone 7 Plus (2016)—Gunmetal”, <https://www.amazon.com/dp/B07519W92L>, Earliest review date of Sep. 14, 2017, Downloaded on Dec. 18, 2019.

“Spigen Neo Hybrid Herringbone iPhone 8 Case/iPhone 7 Case with Flexible Inner Protection and Reinforced Hard Bumper Frame for Apple iPhone 8 (2017) / iPhone 7 (2016)—Gunmetal”, <https://www.amazon.com/dp/B07482P44X>, Earliest review date of Sep. 20, 2017, Downloaded on Dec. 18, 2019.

“Spigen Neo Hybrid Crystal [2nd Generation] iPhone 8 Case/iPhone 7 Case with Clear Hard Casing and Reinforced Hard Bumper Frame for Apple iPhone 8 (2017) / iPhone 7 (2016)—Gunmetal”, <https://www.amazon.com/dp/B0751C7FF2>, Earliest review date of Sep. 22, 2017, Downloaded on Dec. 18, 2019.

* cited by examiner

Primary Examiner — Carla J Wright

(74) *Attorney, Agent, or Firm* — Heedong Chae; Lucem, PC

(57)

CLAIM

The ornamental design for a case for electronic communications device, as shown and described.

DESCRIPTION

FIG. 1 is a front perspective view of a case for electronic communications device showing my new design;

FIG. 2 is a rear perspective view thereof;

FIG. 3 is a front elevational view thereof;

FIG. 4 is a rear elevational view thereof;

FIG. 5 is a left side elevational view thereof;

FIG. 6 is a right side elevational view thereof;

FIG. 7 is a top plan view thereof;

FIG. 8 is a bottom plan view thereof;

FIG. 9 is a front perspective view showing the inner shell component of the case separately for clarity of disclosure;

FIG. 10 is a rear perspective view showing the inner shell component of the case separately for clarity of disclosure;

FIG. 11 is a front perspective view showing the environmental outer frame component of the case in isolation for clarity of disclosure;

FIG. 12 is a rear perspective view showing the environmental outer frame component of the case in isolation for clarity of disclosure;

FIG. 13 is an exploded front perspective view showing the components of the case separated for clarity of disclosure;

FIG. 14 is an exploded rear perspective view showing the components of the case separated for clarity of disclosure;

FIG. 15 is an enlarged detail view of the encircled portion of the design from FIG. 2; and,

FIG. 16 is an enlarged detail view of the encircled portion of the design from FIG. 4.

The dot-dash broken line circles in FIGS. 2, 4, 15, and 16, delineate portions of the claimed design that are shown on an enlarged scale in FIGS. 15 and 16. The dashed broken

lines throughout the drawing figures depict portions of the case for electronic communications device that form no part of the claimed design. The broken lines and regions bounded by dashed broken lines form no part of the claimed design.

1 Claim, 16 Drawing Sheets

FIG. 1

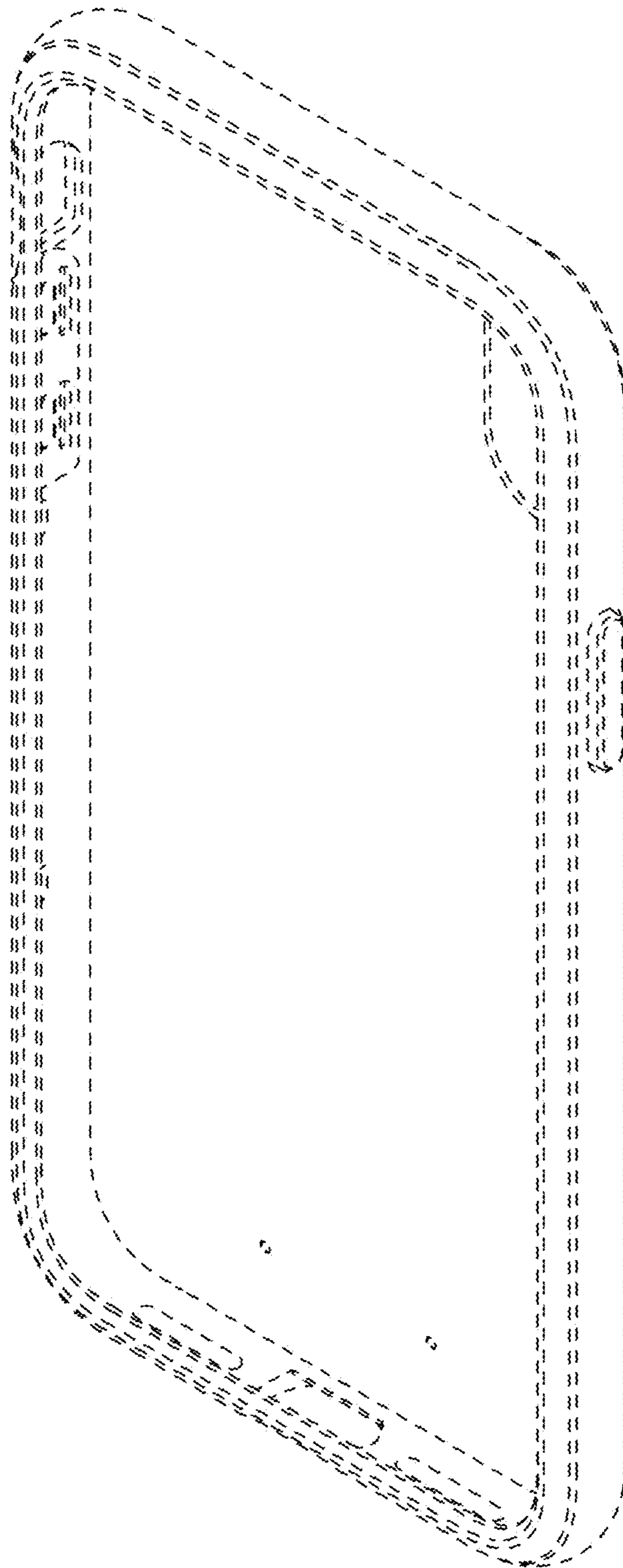

FIG. 2

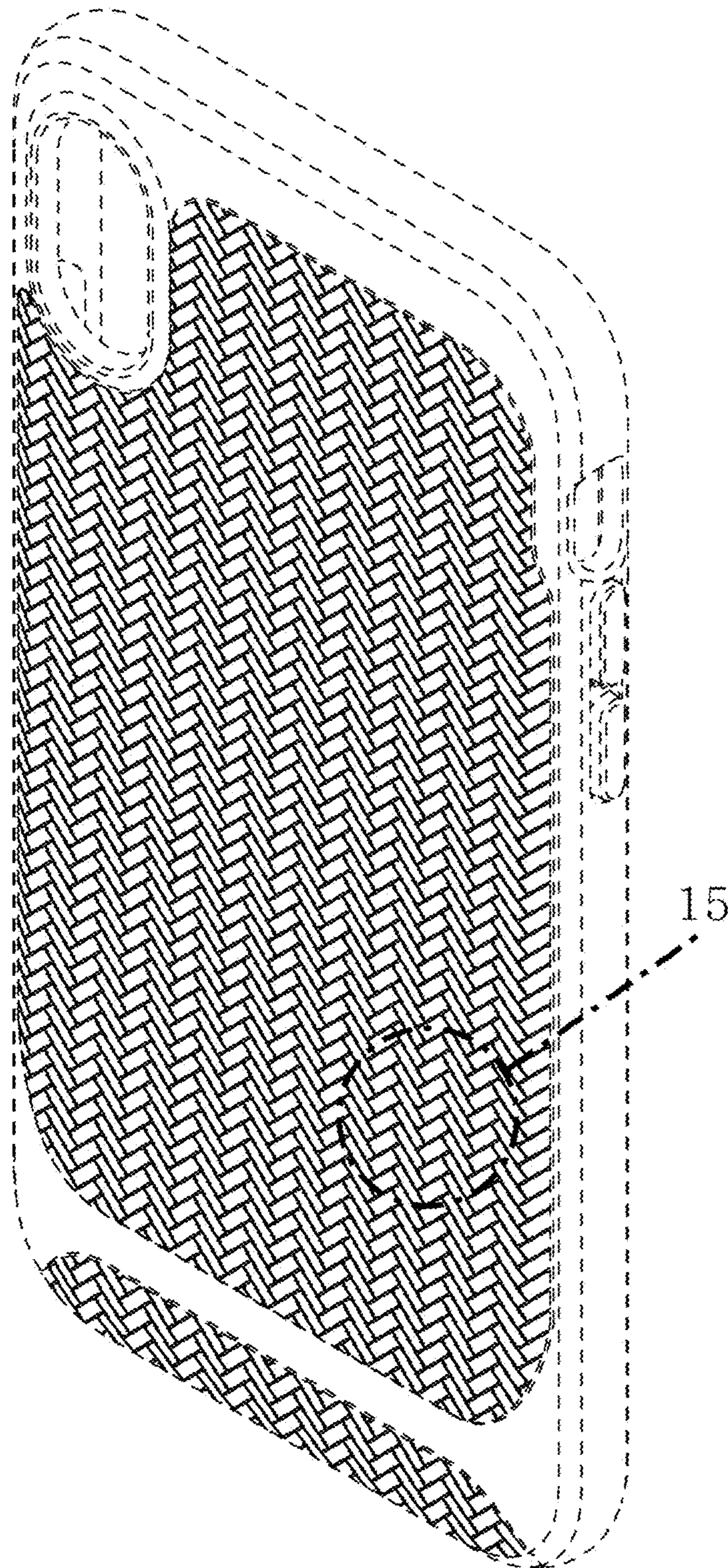

FIG. 3

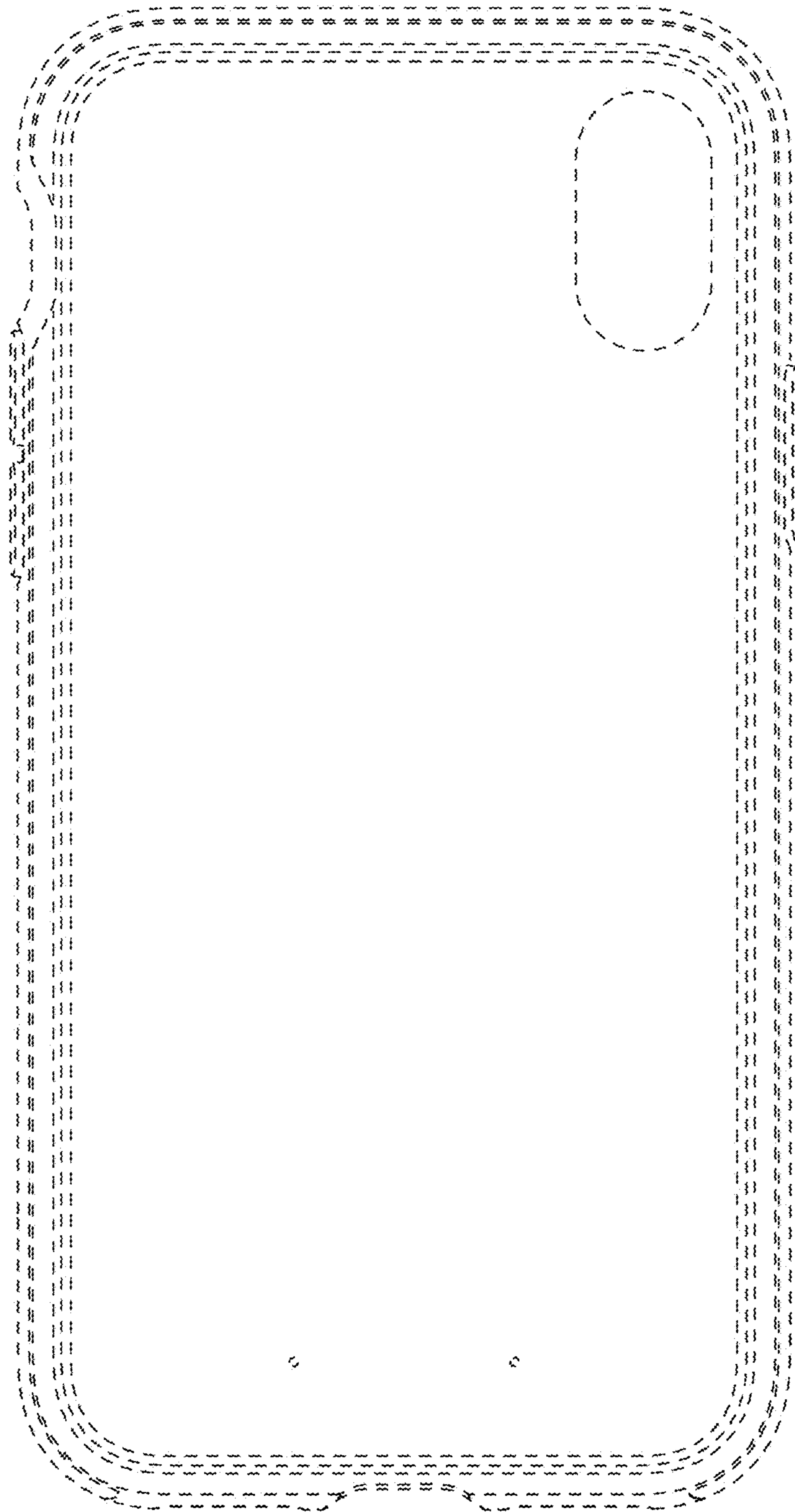

FIG. 4

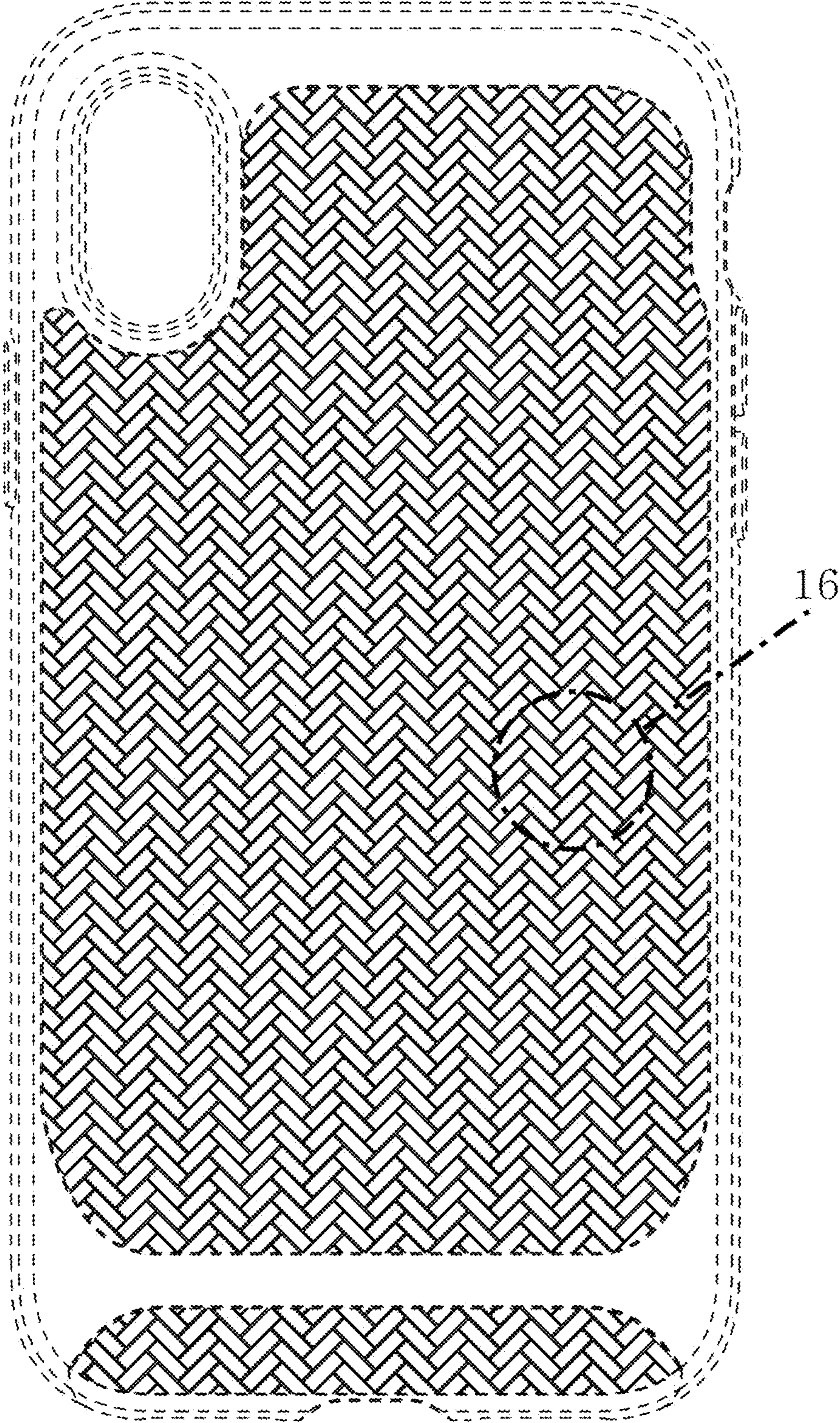

FIG. 5

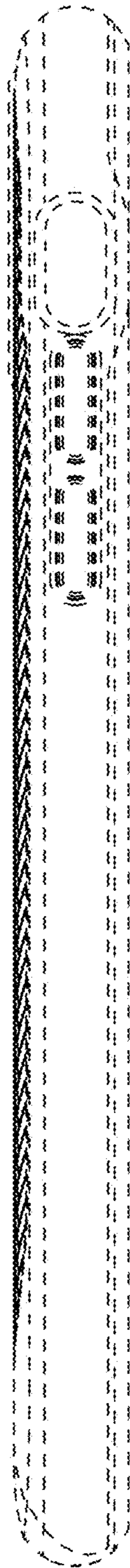

FIG. 6

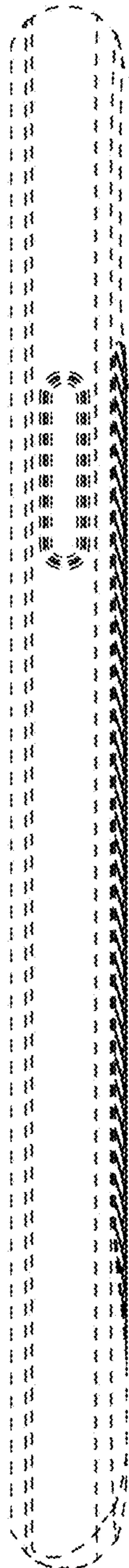

FIG. 7

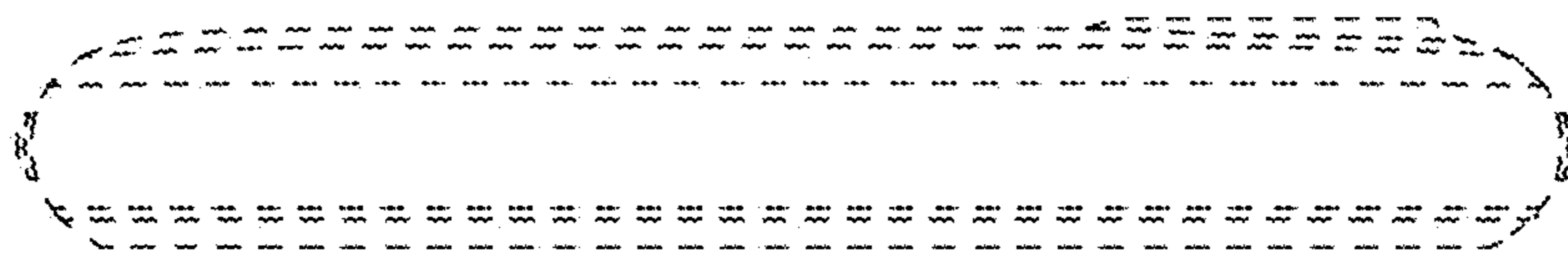

FIG. 8



FIG. 9

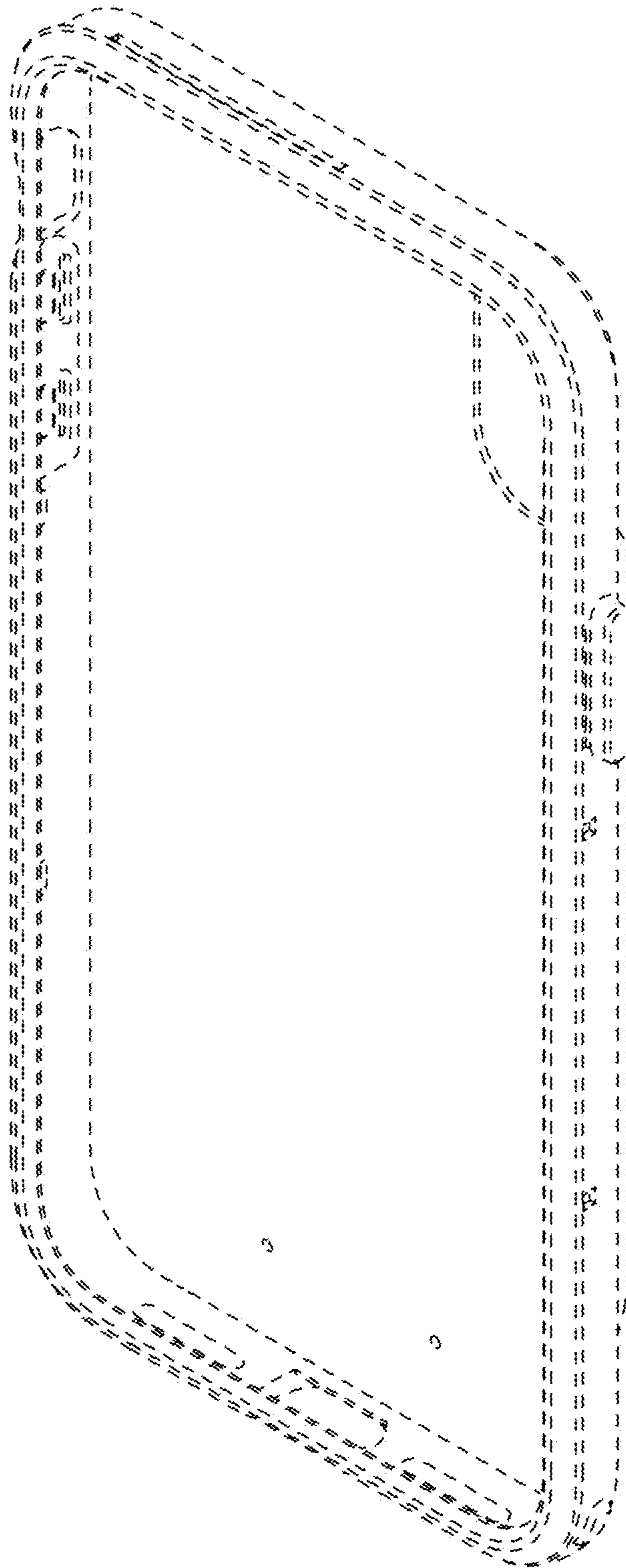

FIG. 10

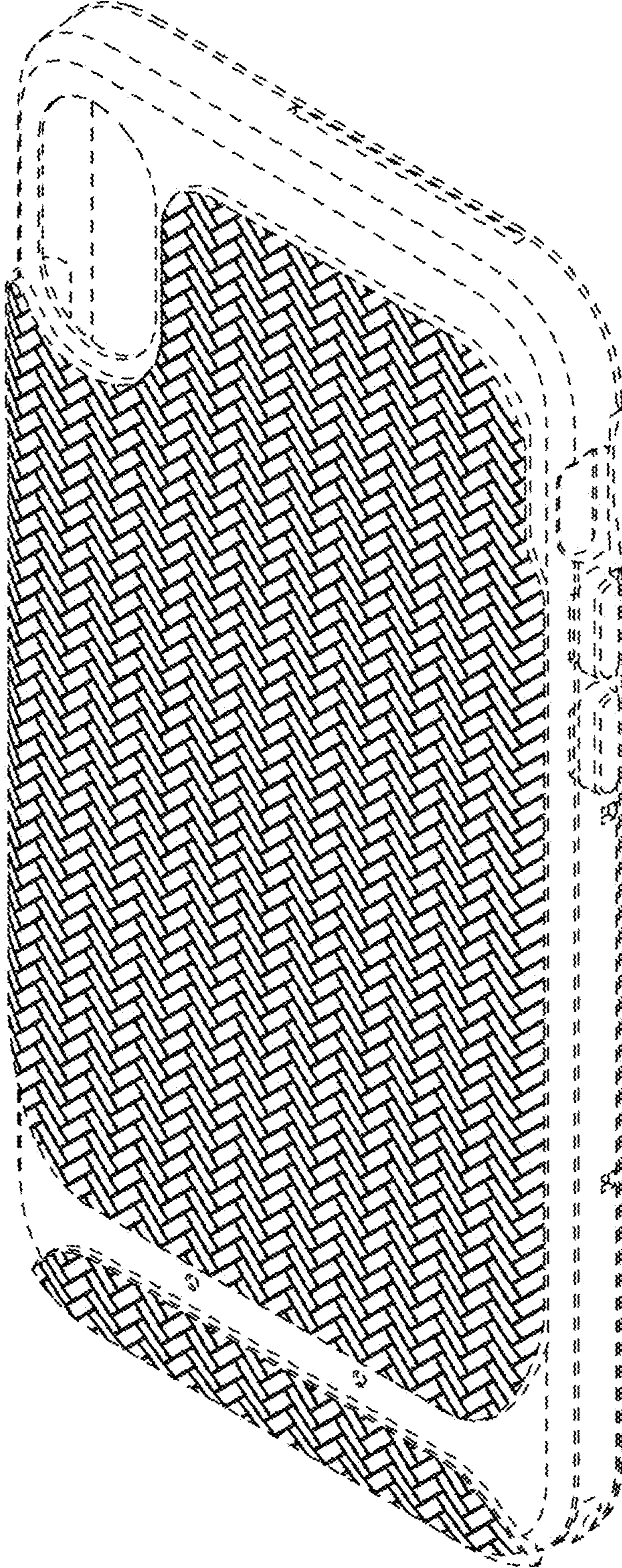

FIG. 11

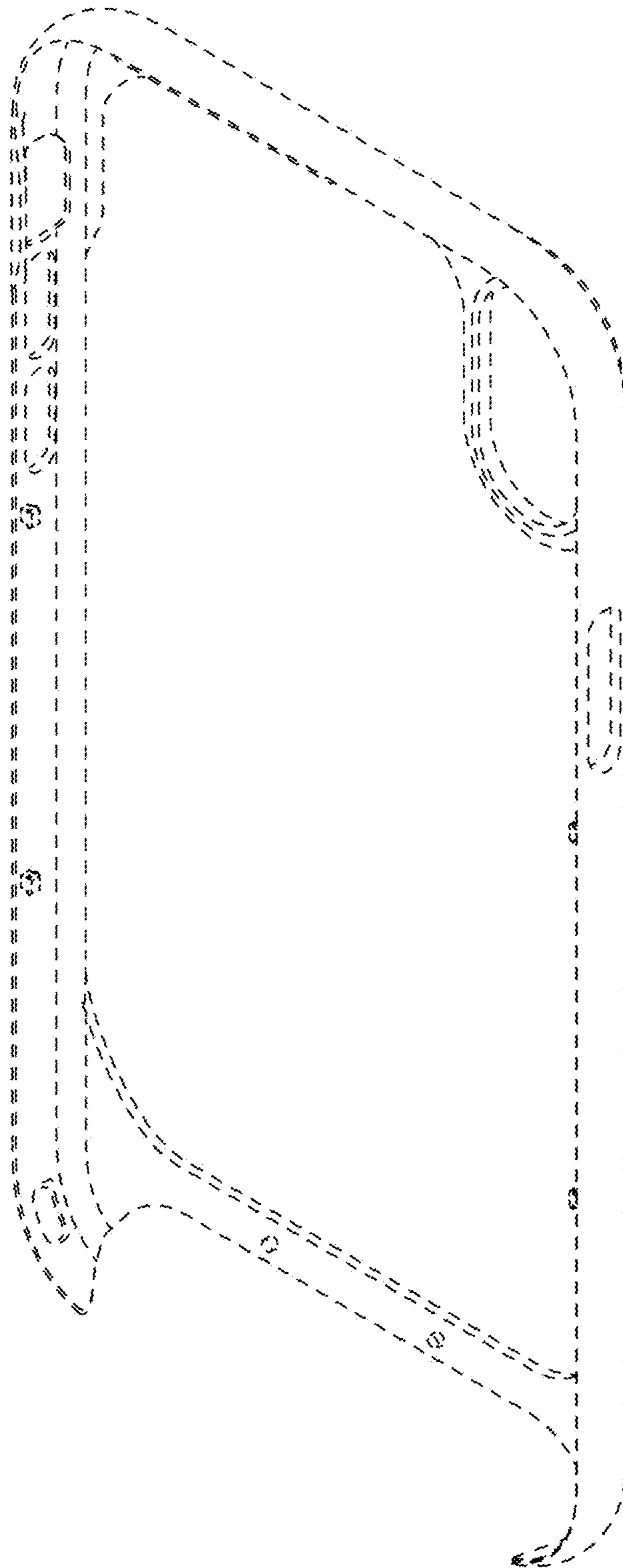

FIG. 12

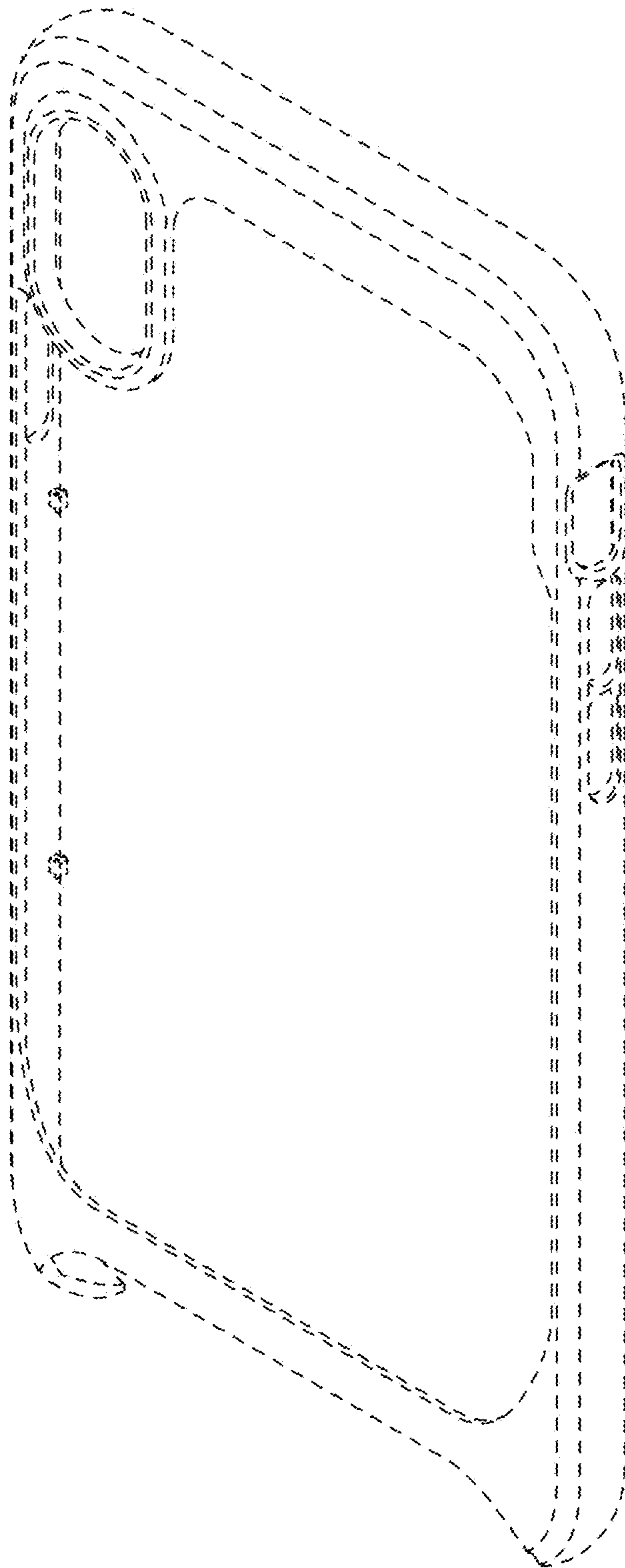

FIG. 13

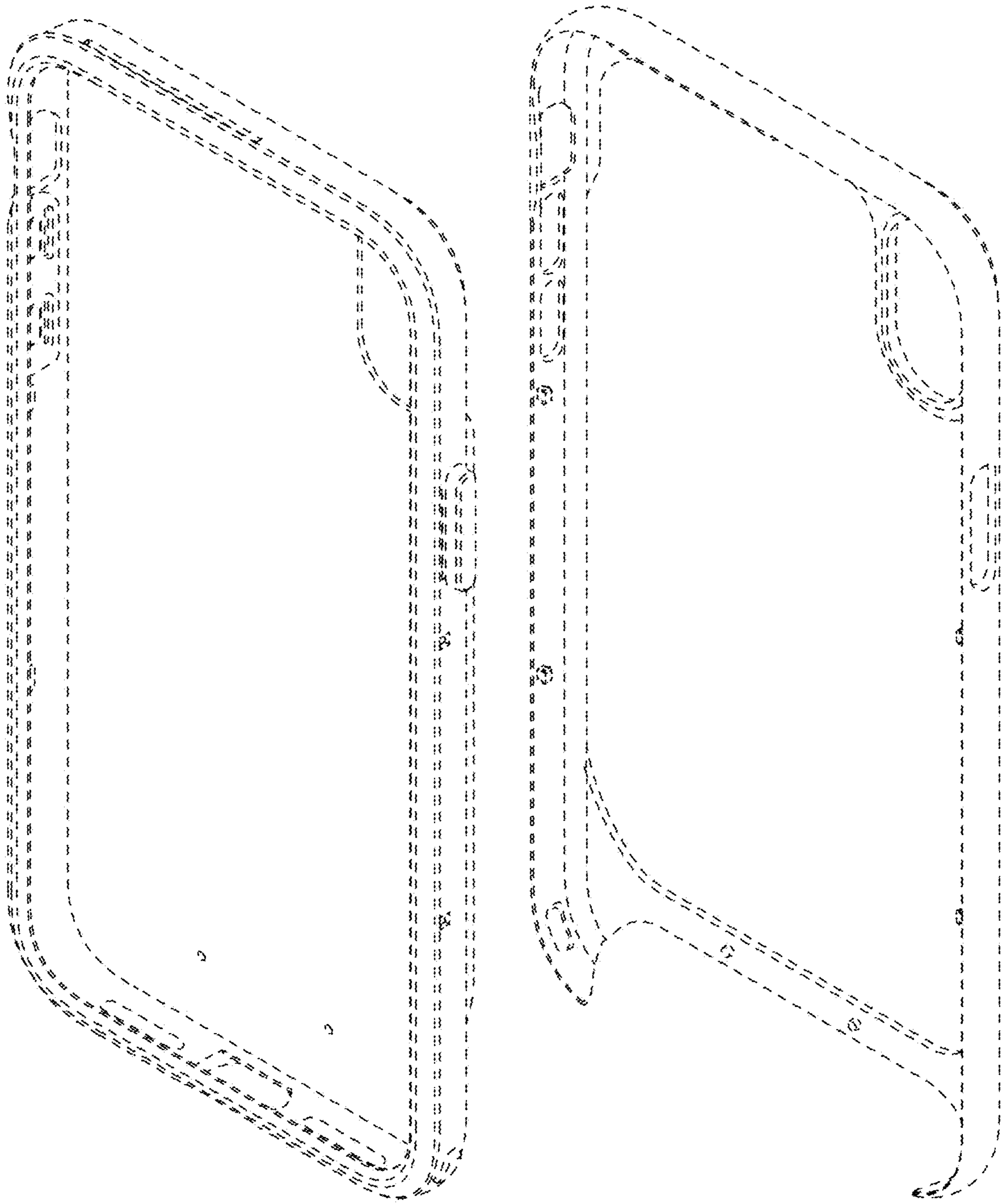

FIG. 14

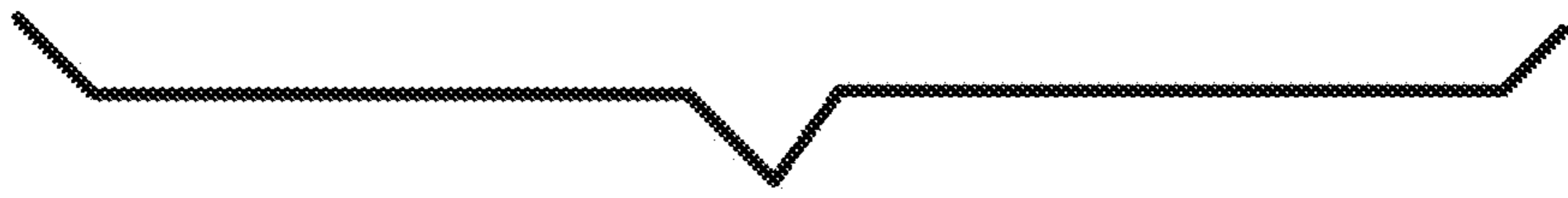
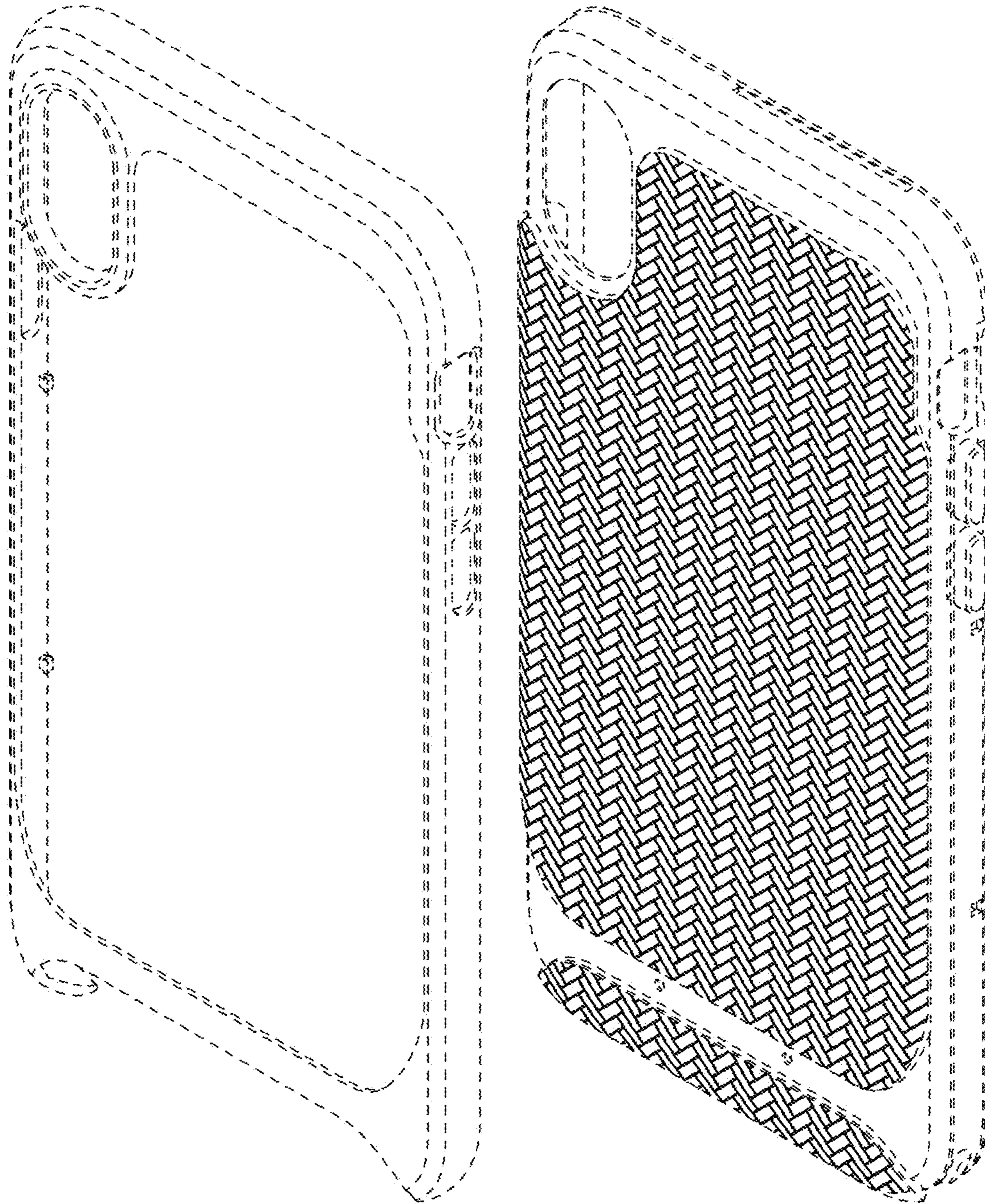

FIG. 15

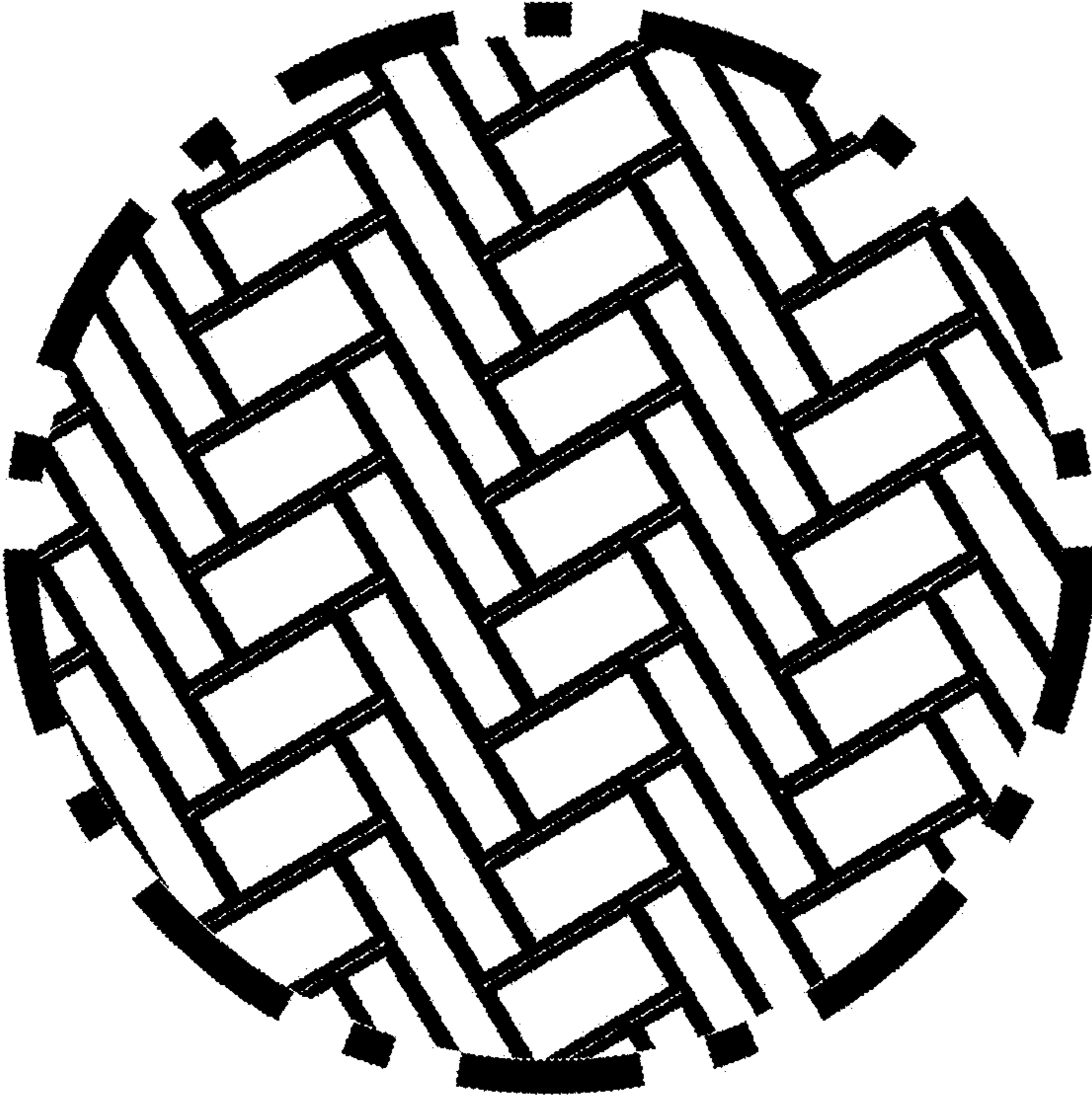

FIG. 16

