



US00D900067S

(12) **United States Design Patent** (10) **Patent No.:** **US D900,067 S**  
**Entelis et al.** (45) **Date of Patent:** **\*\* Oct. 27, 2020**

(54) **SPEAKER STAND**  
(71) Applicant: **Sonos, Inc.**, Santa Barbara, CA (US)  
(72) Inventors: **Dylan Entelis**, Los Angeles, CA (US);  
**Matthew Malone**, Los Angeles, CA (US); **Zachary Scott**, Oakland, CA (US)  
(73) Assignee: **Sonos, Inc.**, Santa Barbara, CA (US)  
(\*\*) Term: **15 Years**

3,194,952 A 7/1965 Wells  
4,033,430 A 7/1977 Bolden  
5,048,789 A 9/1991 Eason et al.  
D326,969 S 6/1992 Eason et al.  
5,169,104 A \* 12/1992 Kwoh ..... F16F 15/00  
248/176.1  
5,485,521 A 1/1996 Yagisawa et al.  
5,734,728 A 3/1998 Meissner  
D414,858 S 10/1999 Litvin et al.  
D415,494 S 10/1999 Curina  
5,995,634 A 11/1999 Zwolski  
D429,809 S 8/2000 Wolfe  
6,122,386 A 9/2000 Wiley

(Continued)

(21) Appl. No.: **29/665,017**  
(22) Filed: **Sep. 28, 2018**  
(51) **LOC (12) Cl.** ..... **14-01**  
(52) **U.S. Cl.**  
USPC ..... **D14/224**  
(58) **Field of Classification Search**  
USPC ..... D14/221, 224, 225, 226, 227, 228, 229,  
D14/150, 154, 155, 158, 160, 172  
CPC ..... H04R 19/04; H04R 19/00; H04R 1/406;  
H04R 1/08; H04R 1/04; H04R 1/326;  
H04R 29/004; H04R 2410/00; H04R  
2410/01; H04R 2410/03; H04R 2410/05;  
H04R 2410/07; H04R 2420/07; H04R  
17/02

See application file for complete search history.

(56) **References Cited**  
U.S. PATENT DOCUMENTS  
D84,831 S 8/1931 Kehoe  
1,819,183 A 8/1931 Ludlow  
D89,053 S 1/1933 Mitchell et al.  
1,893,799 A 1/1933 Harrington  
1,970,624 A 8/1934 Recker  
D131,623 S 3/1942 Tackaserry  
D131,669 S 3/1942 Kisling  
2,447,924 A 8/1948 Vitale  
2,495,785 A 1/1950 Stephens  
2,888,090 A 5/1959 Wylezik

**OTHER PUBLICATIONS**

Sonos—Speaker Stands, announced 2019 [online], retrieved Mar. 10, 2020, retrieved from internet, <https://www.bestbuy.com/site/sonos-speaker-stands-2-pack-black/6332083.p?skuId=6332083>.\*

(Continued)

*Primary Examiner* — Dana K Weiland  
*Assistant Examiner* — Messina L Smith  
(74) *Attorney, Agent, or Firm* — KPPB LLP

(57) **CLAIM**

The ornamental design for a speaker stand, as shown and described.

**DESCRIPTION**

FIG. 1 is a front elevation view of a speaker stand showing our new design;  
FIG. 2 is rear elevation view thereof;  
FIG. 3 is a left side elevation view thereof;  
FIG. 4 is a right side elevation view thereof;  
FIG. 5 is a top plan view thereof;  
FIG. 6 is a bottom plan view thereof; and,  
FIG. 7 is a perspective view thereof.  
The broken lines in the drawings depict portions of the speaker stand that form no part of the claimed design.

**1 Claim, 4 Drawing Sheets**

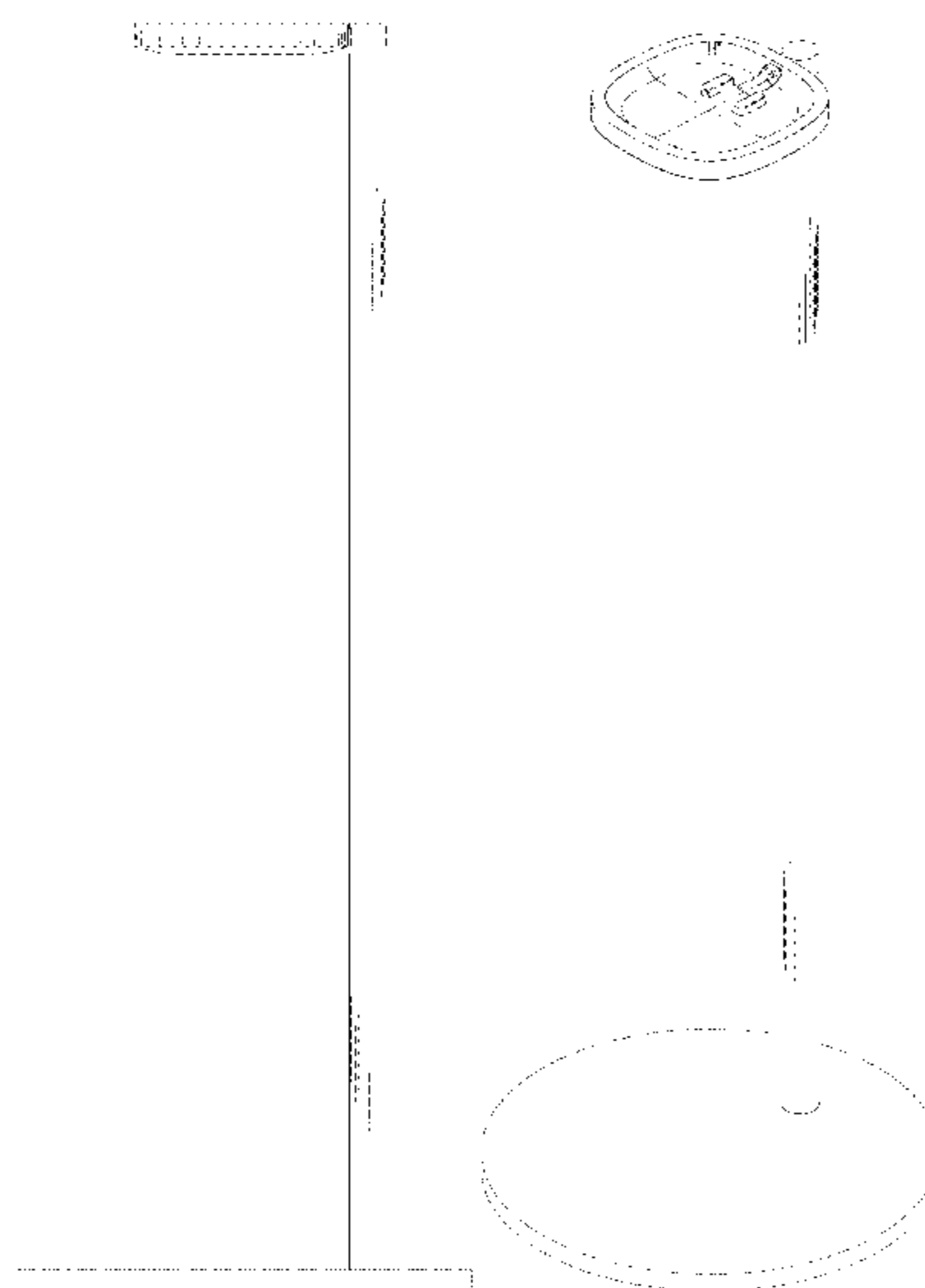

(56)

**References Cited**

U.S. PATENT DOCUMENTS

D454,263 S 3/2002 Worrall  
 D459,646 S 7/2002 Bertani  
 6,454,428 B1 9/2002 Bruzon  
 D483,026 S 12/2003 Koskinen  
 D488,803 S 4/2004 Chin et al.  
 6,719,091 B1 4/2004 Brown  
 D494,572 S 8/2004 Moeller  
 D497,904 S 11/2004 Dardashti  
 D579,926 S 11/2008 Whitworth  
 D579,927 S 11/2008 Whitworth  
 D581,697 S \* 12/2008 Fix ..... D6/681.2  
 D581,698 S 12/2008 Fix  
 7,575,095 B2 8/2009 An et al.  
 7,606,379 B2 10/2009 Ivey et al.  
 D610,570 S 2/2010 Upham et al.  
 D638,406 S 5/2011 Chiang  
 D691,117 S 10/2013 Silvera  
 D694,451 S 11/2013 Fang  
 D702,214 S 4/2014 Son  
 D716,764 S \* 11/2014 Jeon ..... D14/209.1

D723,011 S \* 2/2015 Symons ..... D14/224  
 D724,570 S \* 3/2015 Kusano ..... D14/224  
 D743,371 S \* 11/2015 Nardin ..... D14/209.1  
 D743,378 S \* 11/2015 Kim ..... D14/213  
 D783,000 S \* 4/2017 Koo ..... D14/209.1  
 D785,380 S \* 5/2017 King ..... D6/681  
 D788,080 S \* 5/2017 Turksu ..... D14/224  
 D793,996 S \* 8/2017 Katz ..... D14/224  
 D821,365 S \* 6/2018 Gheysens ..... D14/224  
 D855,038 S \* 7/2019 Hu ..... D14/224  
 D866,533 S \* 11/2019 Chong ..... D14/224  
 D868,753 S \* 12/2019 Kolton ..... D14/224  
 2017/0251293 A1 \* 8/2017 Green ..... H02J 7/00

OTHER PUBLICATIONS

Sonos Speaker Stands for One and Play:1, announced © 2020 [online], retrieved Mar. 10, 2020, retrieved from internet, [https://www.visions.ca/product-detail/48183/sonos\\_speaker\\_stands\\_for\\_one\\_and\\_play\\_1\\_white\\_pair?categoryId=0&sku=SS1FSWW1WHT.\\*](https://www.visions.ca/product-detail/48183/sonos_speaker_stands_for_one_and_play_1_white_pair?categoryId=0&sku=SS1FSWW1WHT.*)

\* cited by examiner

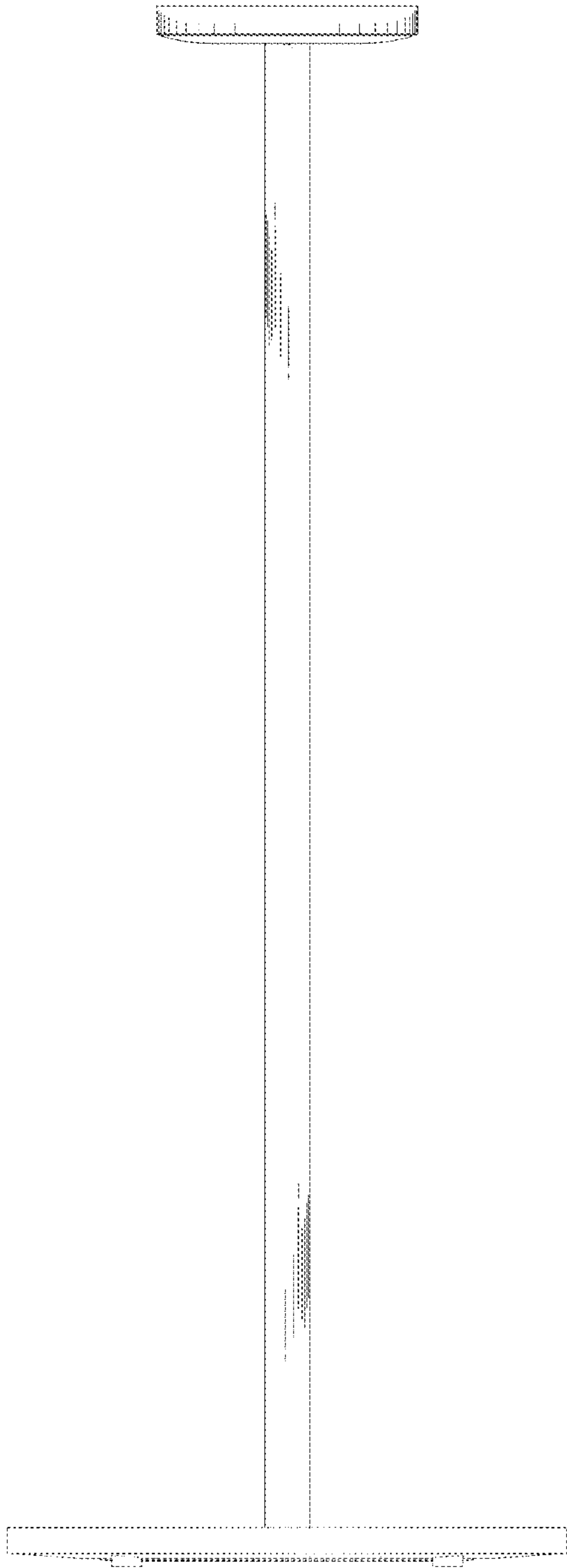

FIG. 1

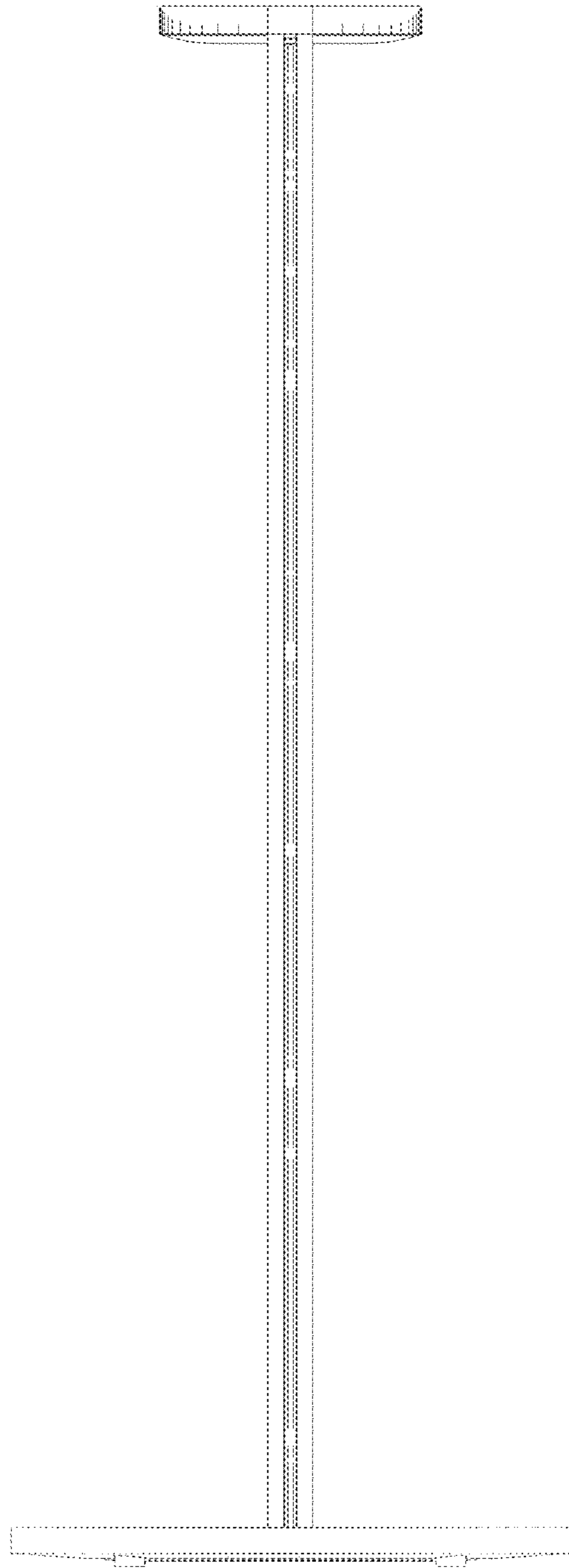

FIG. 2

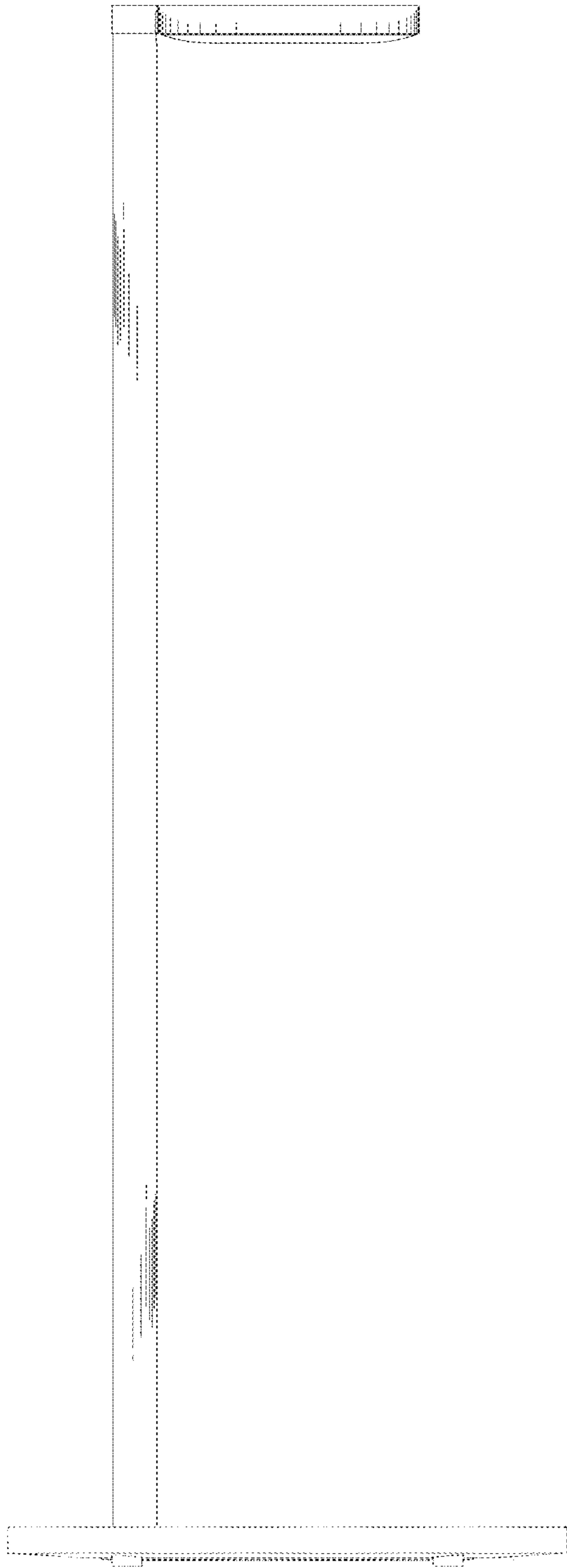

FIG. 3

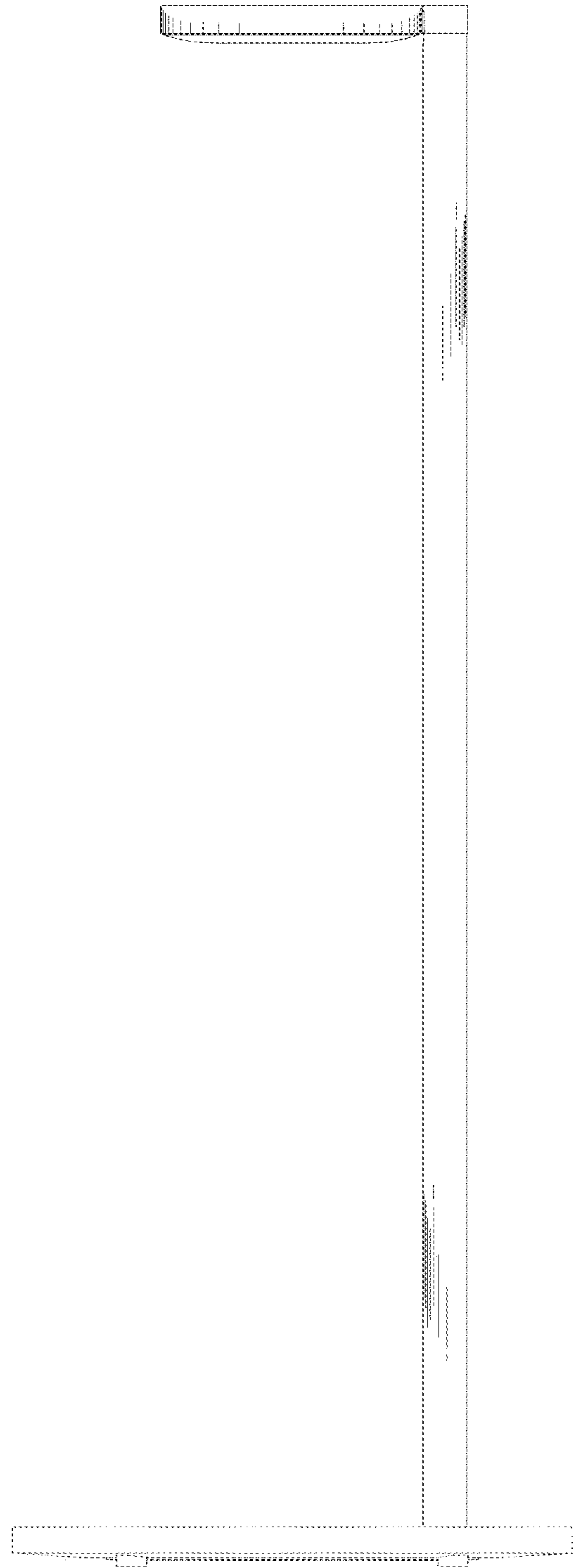

FIG. 4

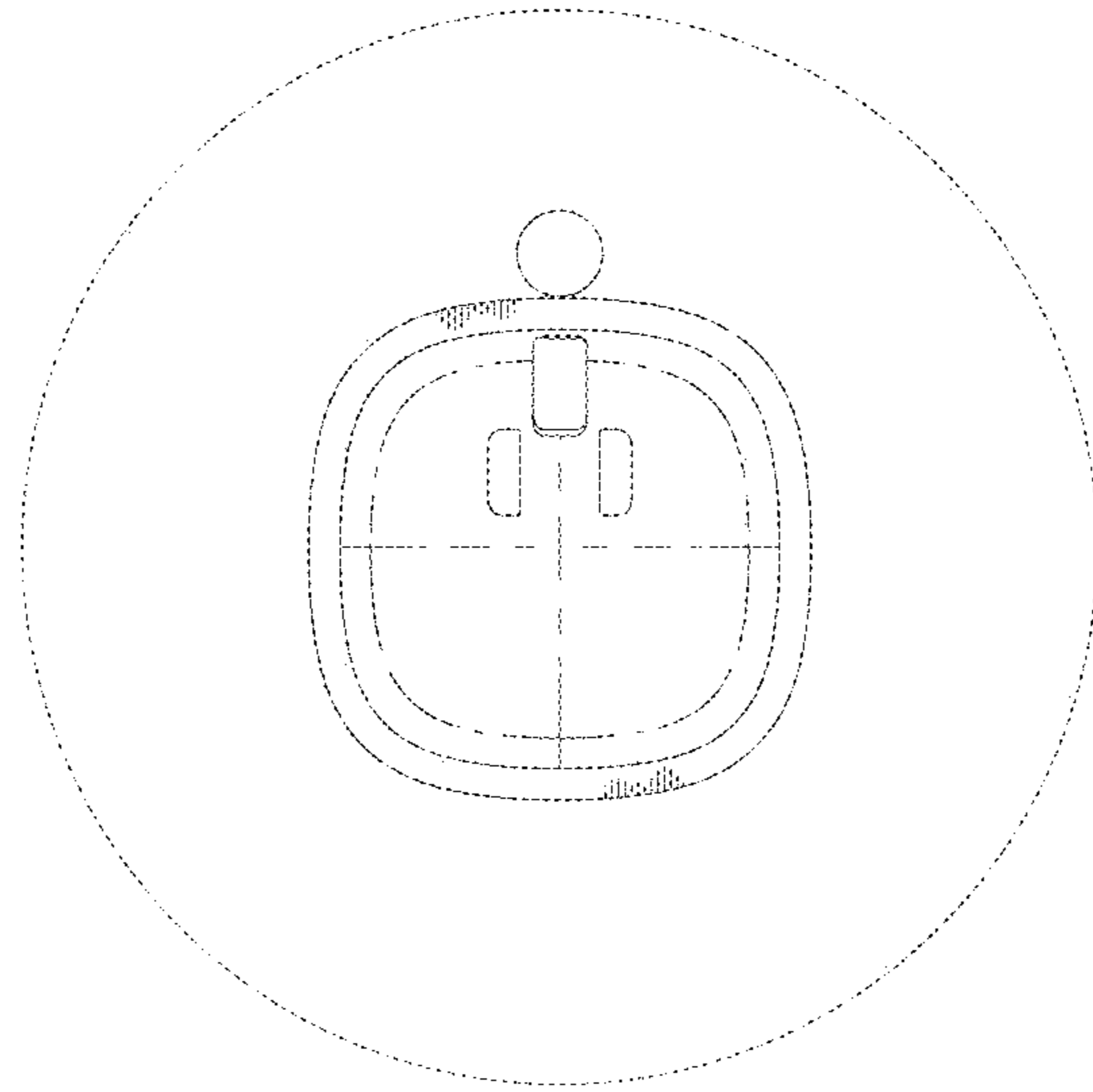

FIG. 5

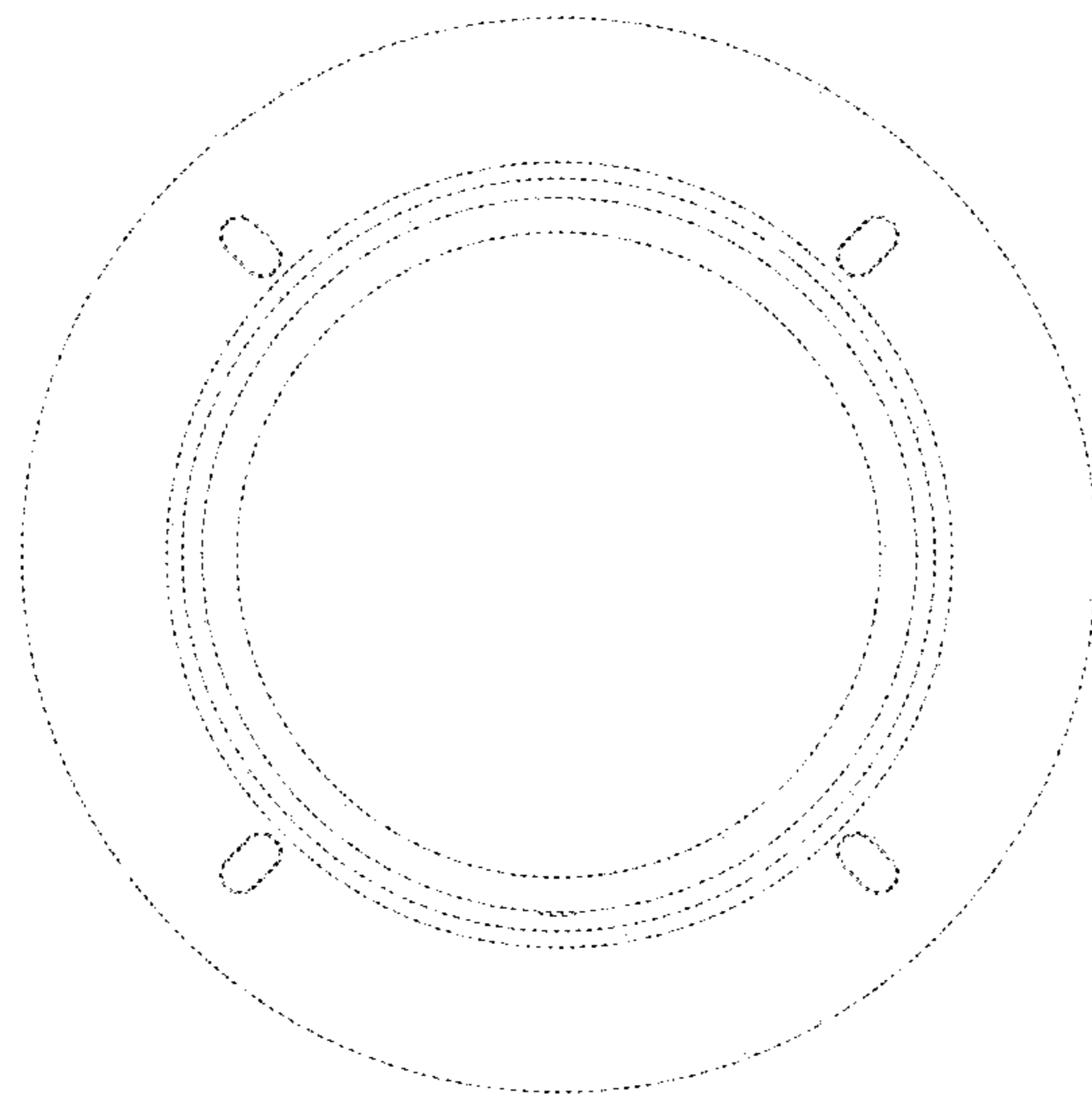

FIG. 6

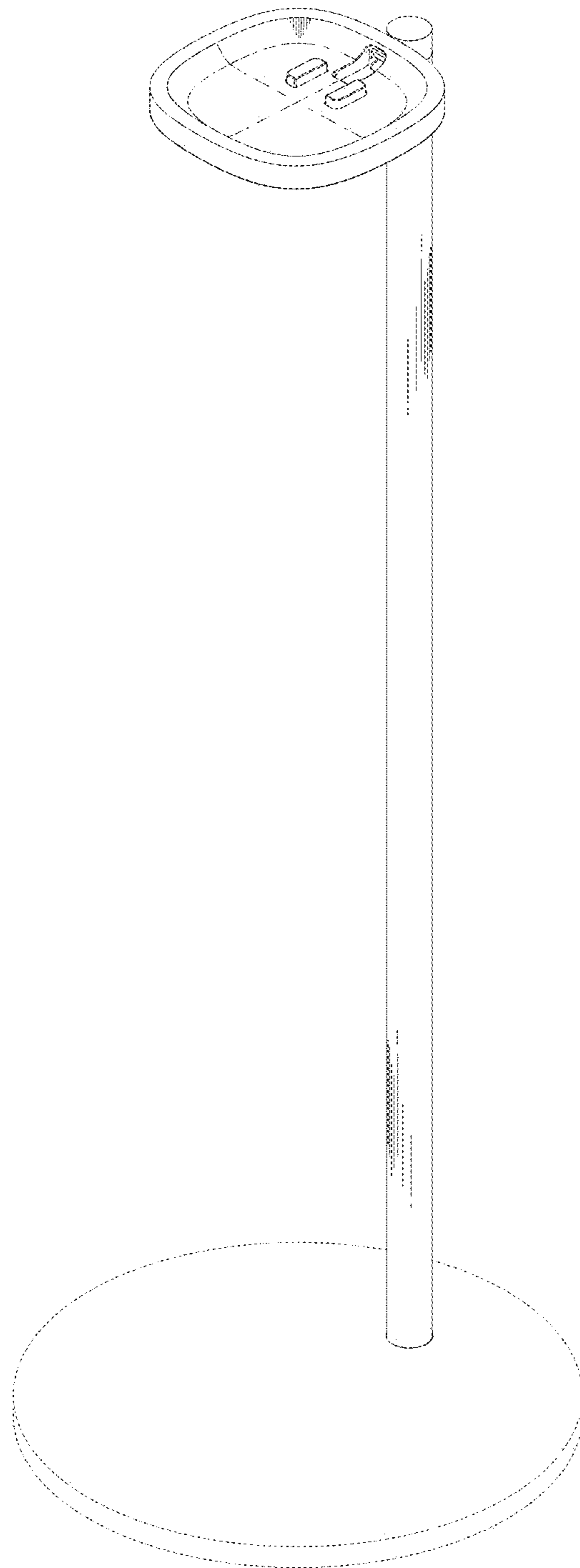

FIG. 7