



(12) **United States Design Patent**
Chan

(10) **Patent No.:** **US D899,967 S**
(45) **Date of Patent:** **** Oct. 27, 2020**

(54) **SNAP BUTTON**

(71) Applicant: **Duraflex Hong Kong Limited**, Hong Kong (HK)

(72) Inventor: **Man Chak Chan**, Hong Kong (HK)

(73) Assignee: **Duraflex Hong Kong Limited**, Hong Kong (HK)

(**) Term: **15 Years**

(21) Appl. No.: **29/688,690**

(22) Filed: **Apr. 23, 2019**

(51) **LOC (12) Cl.** **11-07**

(52) **U.S. Cl.**
USPC **D11/220**

(58) **Field of Classification Search**
USPC D11/1-25.43, 86, 87, 220
CPC .. A44C 1/00; A44C 7/00; A44C 7/002; A44C 7/003; A44B 7/00; A44B 7/0005; A44B 7/0017; A44B 7/0023; A44B 7/0029;
(Continued)

(56) **References Cited**

U.S. PATENT DOCUMENTS

D466,439 S * 12/2002 Wagner D11/220
D642,089 S * 7/2011 Chan D11/220
(Continued)

Primary Examiner — Zenia I Bennett

(57) **CLAIM**

The ornamental design for a snap button, as shown and described.

DESCRIPTION

FIG. 1 is a front elevational view of the female portion of a snap button showing my new design;
FIG. 2 is a rear elevational view of FIG. 1;

FIG. 3 is a left side view of FIG. 1;
FIG. 4 is a right side view of FIG. 1;
FIG. 5 is a top plan view of FIG. 1;
FIG. 6 is a bottom plan view of FIG. 1;
FIG. 7 is a top, front and right side perspective view of FIG. 1;
FIG. 8 is a top, front and left side perspective view of FIG. 1;
FIG. 9 is a top, rear and right side perspective view of FIG. 1;
FIG. 10 is a top, rear and left side perspective view of FIG. 1;
FIG. 11 is a front elevational view of the male portion of the snap button;
FIG. 12 is a rear elevational view of FIG. 11;
FIG. 13 is a left side view of FIG. 11;
FIG. 14 is a right side view of FIG. 11;
FIG. 15 is a top plan view of FIG. 11;
FIG. 16 is a bottom plan view of FIG. 11;
FIG. 17 is a top, front and right side perspective view of FIG. 11;
FIG. 18 is a top, front and left side perspective view of FIG. 11;
FIG. 19 is a top, rear and right side perspective view of FIG. 11;
FIG. 20 is a top, rear and left side perspective view of FIG. 11;
FIG. 21 is a front elevational view of the snap button;
FIG. 22 is a rear elevational view of FIG. 21;
FIG. 23 is a left side view of FIG. 21;
FIG. 24 is a right side view of FIG. 21;
FIG. 25 is a top plan view of FIG. 21;
FIG. 26 is a bottom plan view of FIG. 21;
FIG. 27 is a top, rear and right side perspective view of FIG. 21;
FIG. 28 is a top, rear and left side perspective view of FIG. 21;
FIG. 29 is a top, front and right side perspective view of FIG. 21; and,
FIG. 30 is a top, front and left side perspective view of FIG. 21.

1 Claim, 30 Drawing Sheets

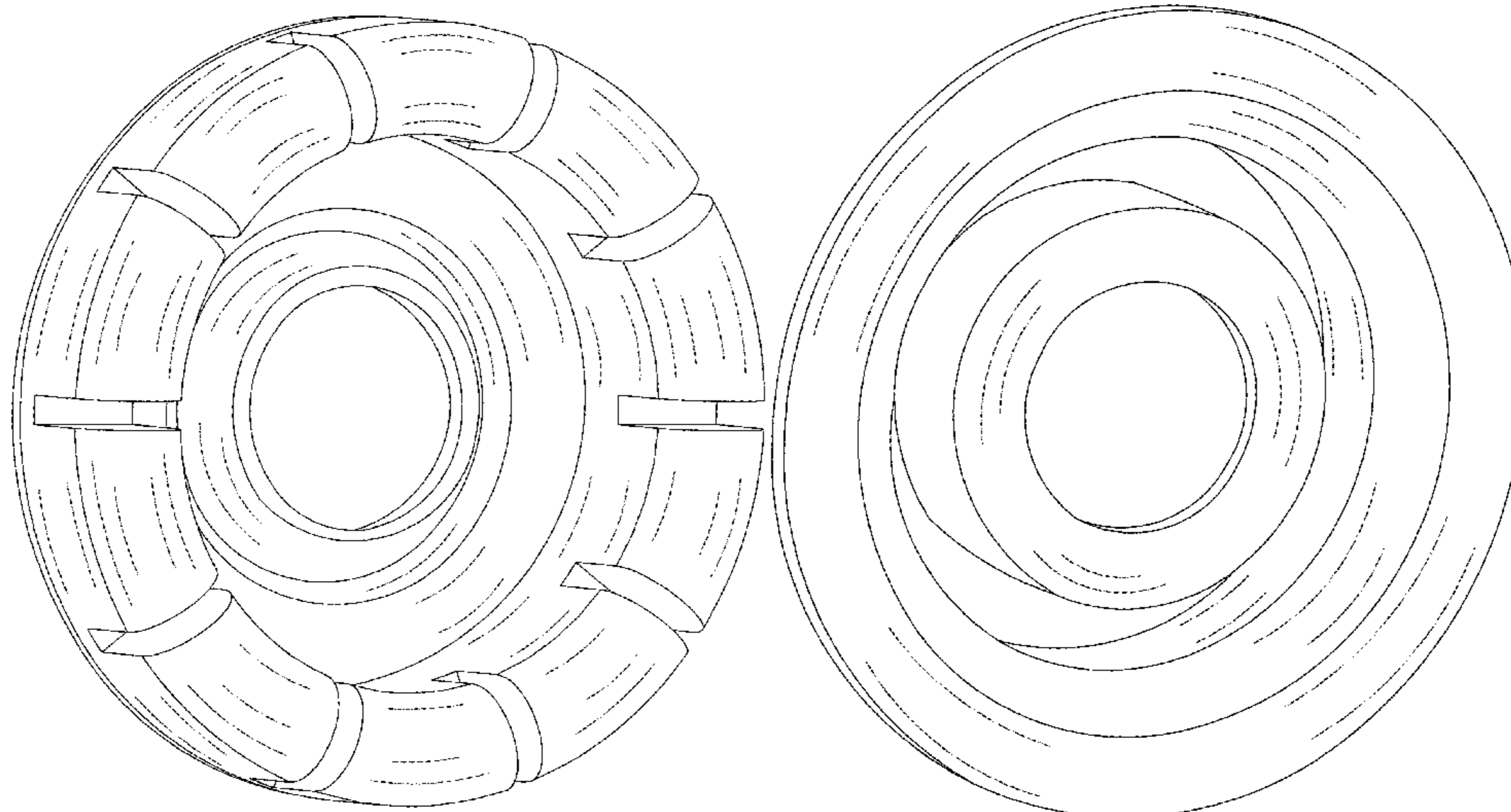

(58) **Field of Classification Search**

CPC .. A44B 7/0035; A44B 7/0041; A44B 7/0058;
A44B 7/0064

See application file for complete search history.

(56) **References Cited**

U.S. PATENT DOCUMENTS

D728,420 S *	5/2015	Leung	D11/220
D840,871 S *	2/2019	Leung	D11/220
D860,045 S *	9/2019	Oakley	A63F 9/0669
			D11/220
D880,352 S *	4/2020	Chan	D11/220

* cited by examiner

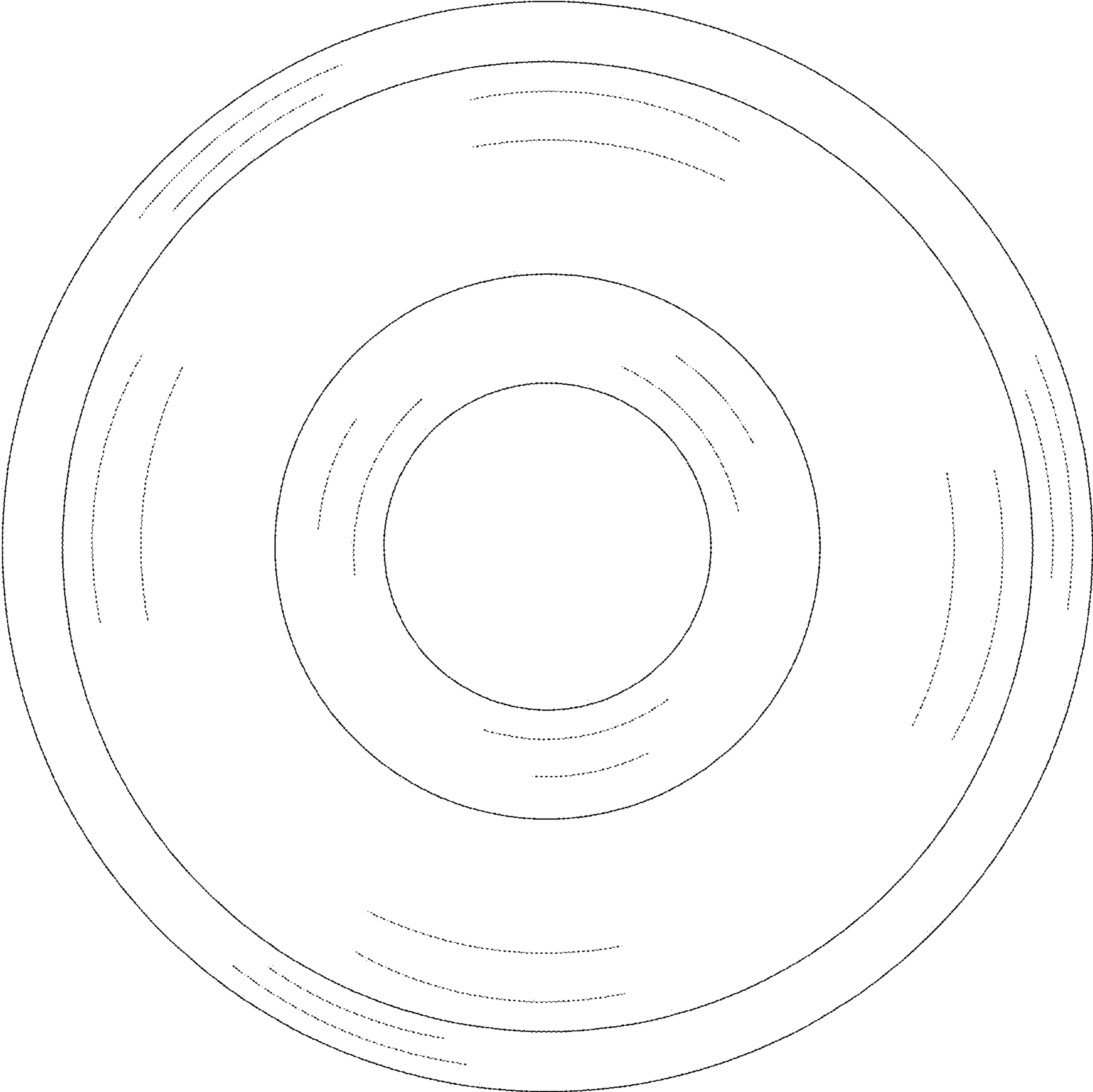

Fig. 1

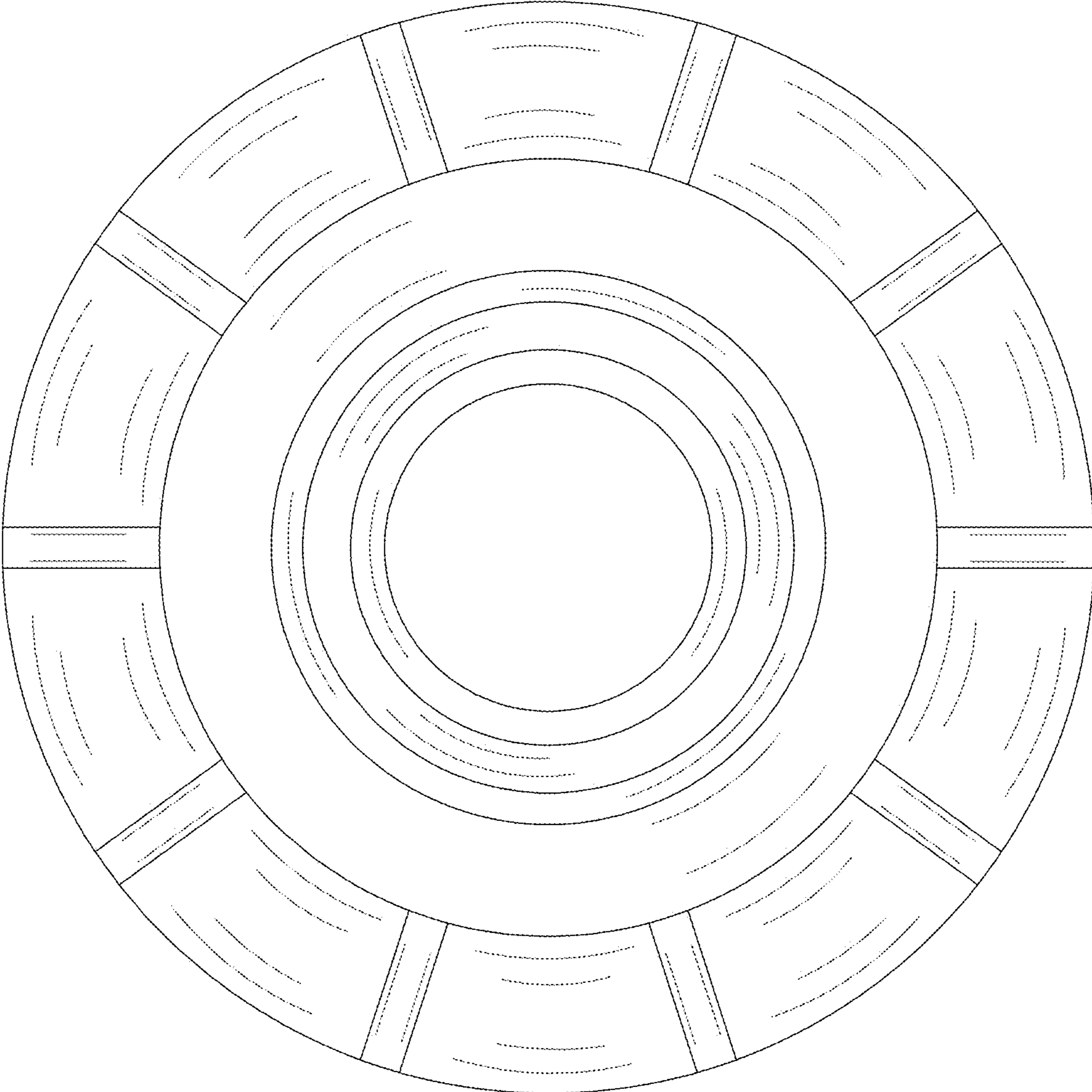

Fig. 2

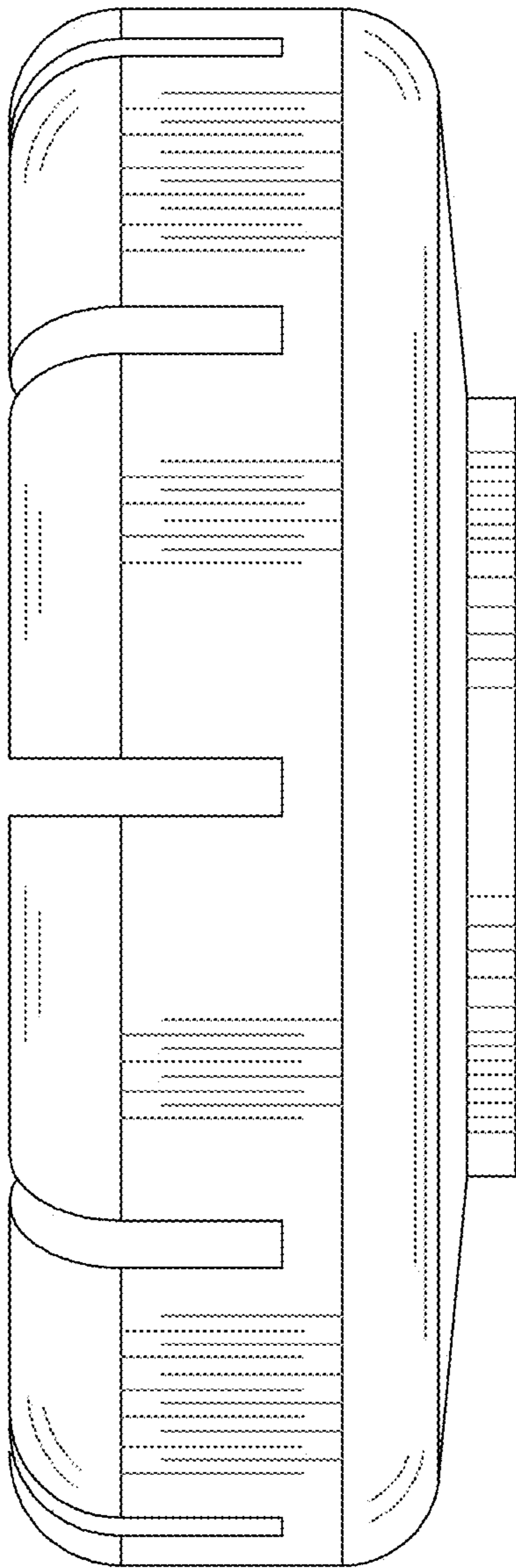

Fig. 3

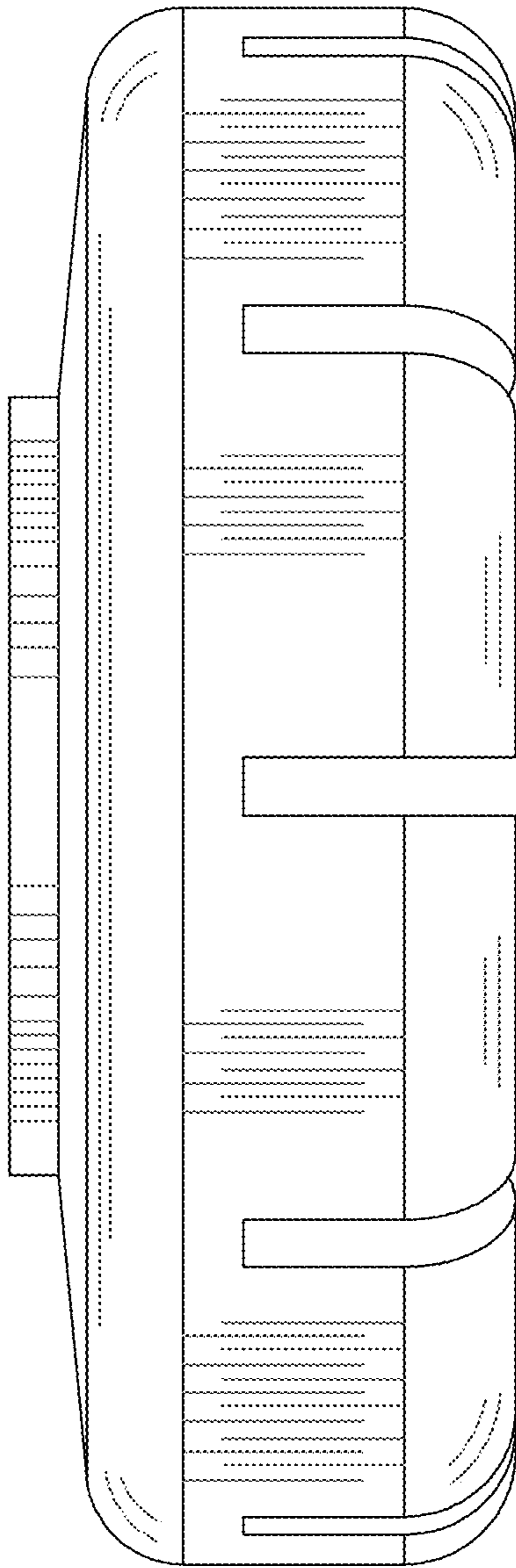

Fig. 4

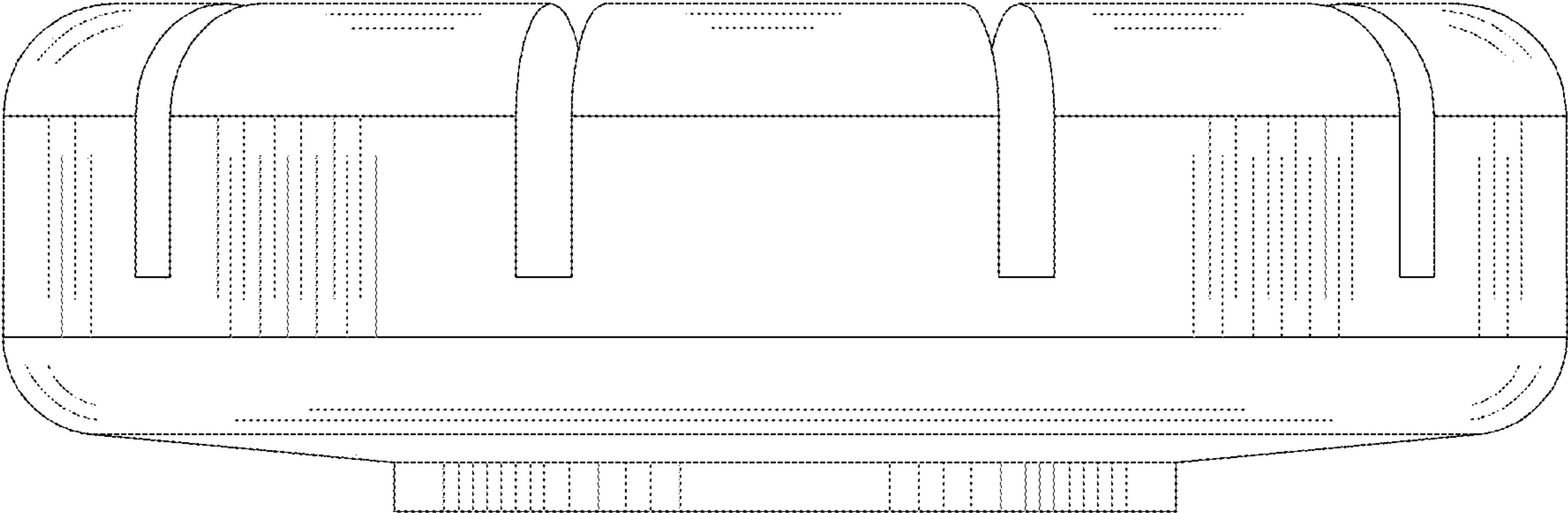

Fig. 5

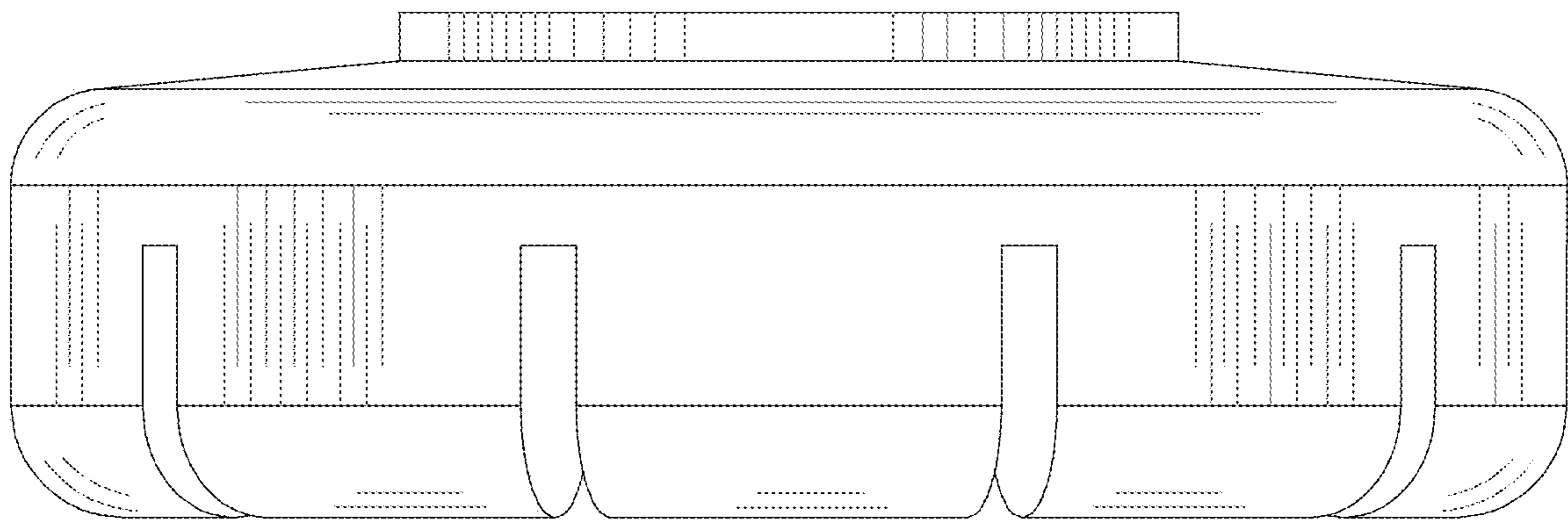

Fig. 6

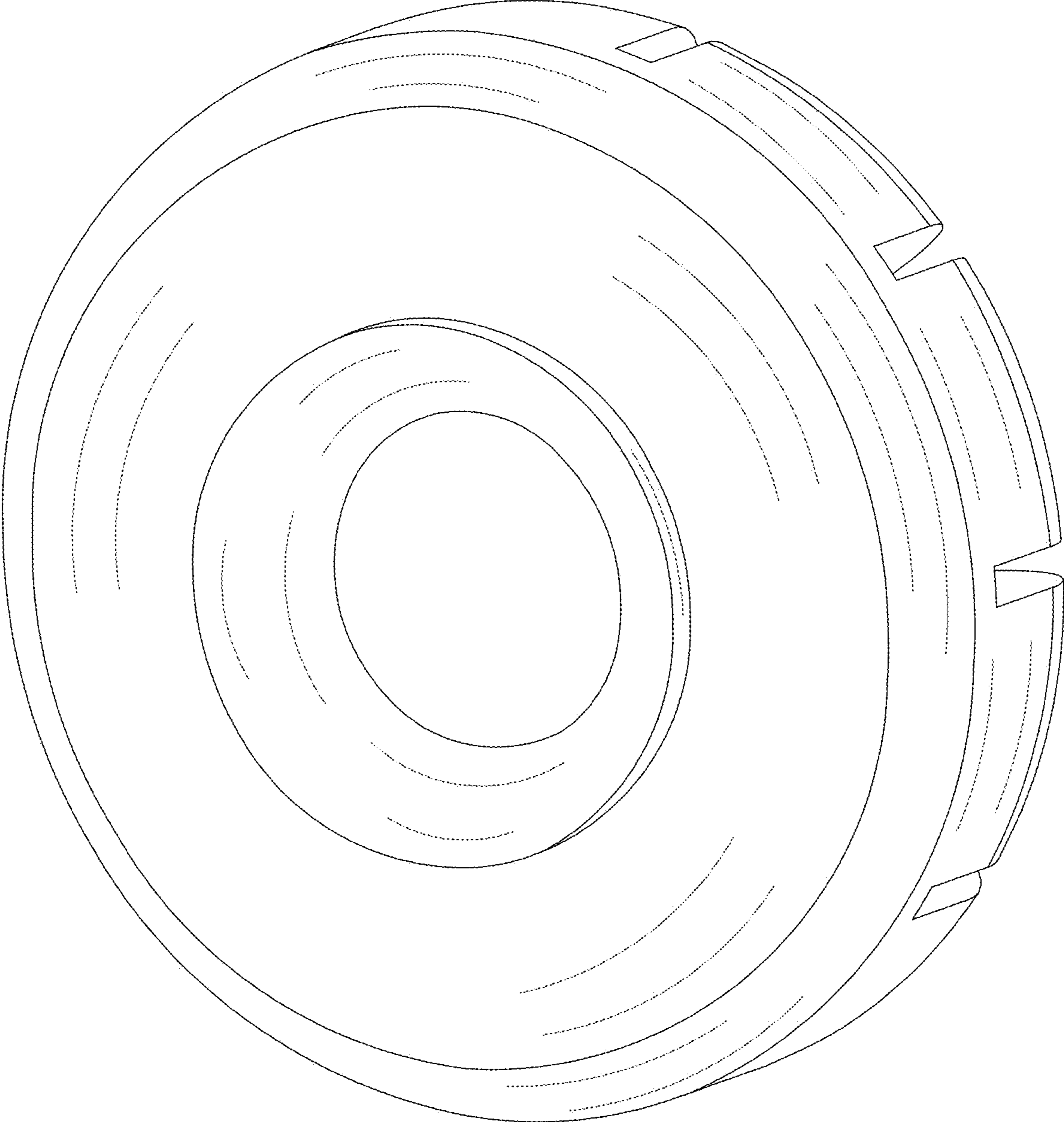

Fig. 7

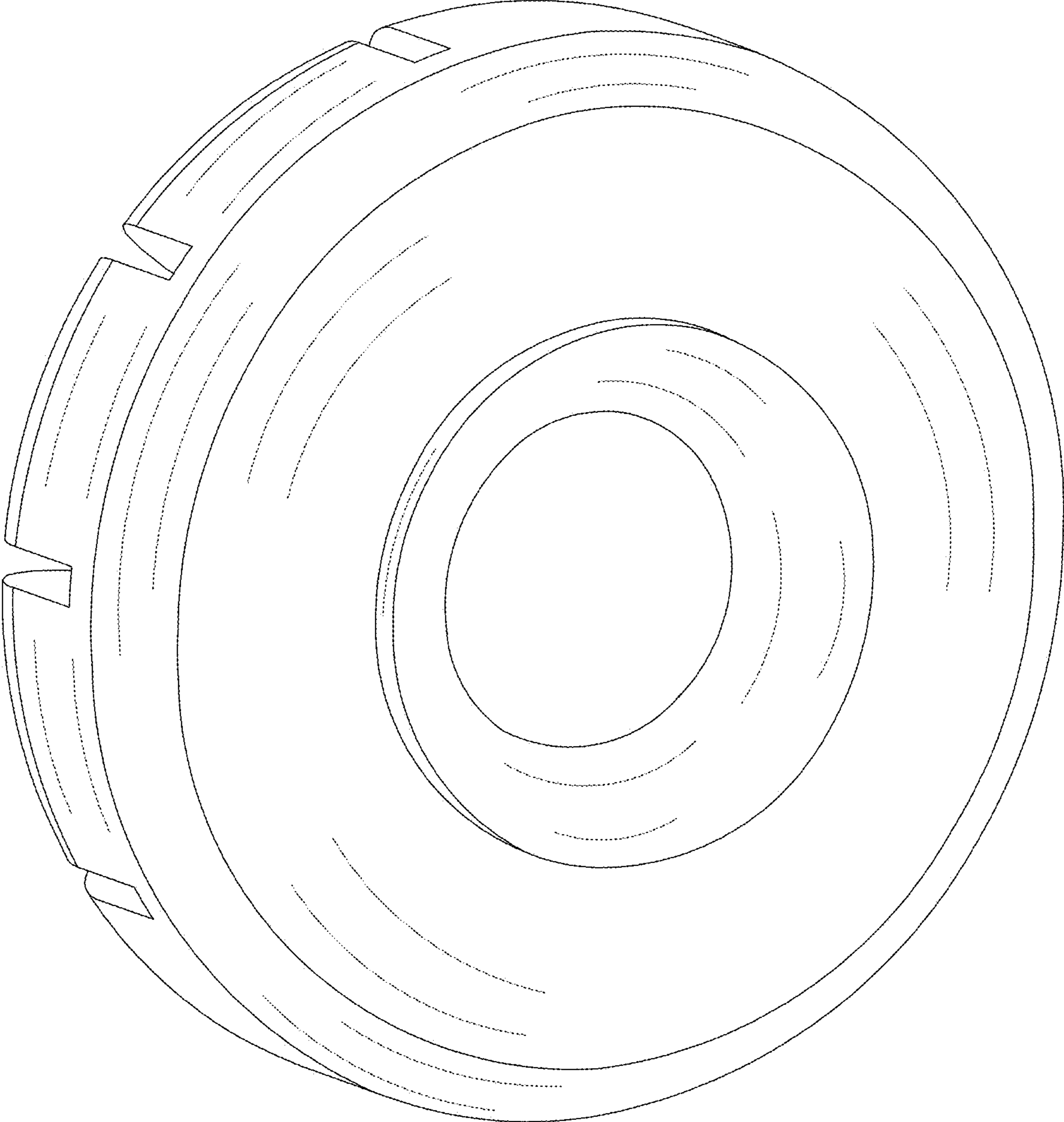

Fig. 8

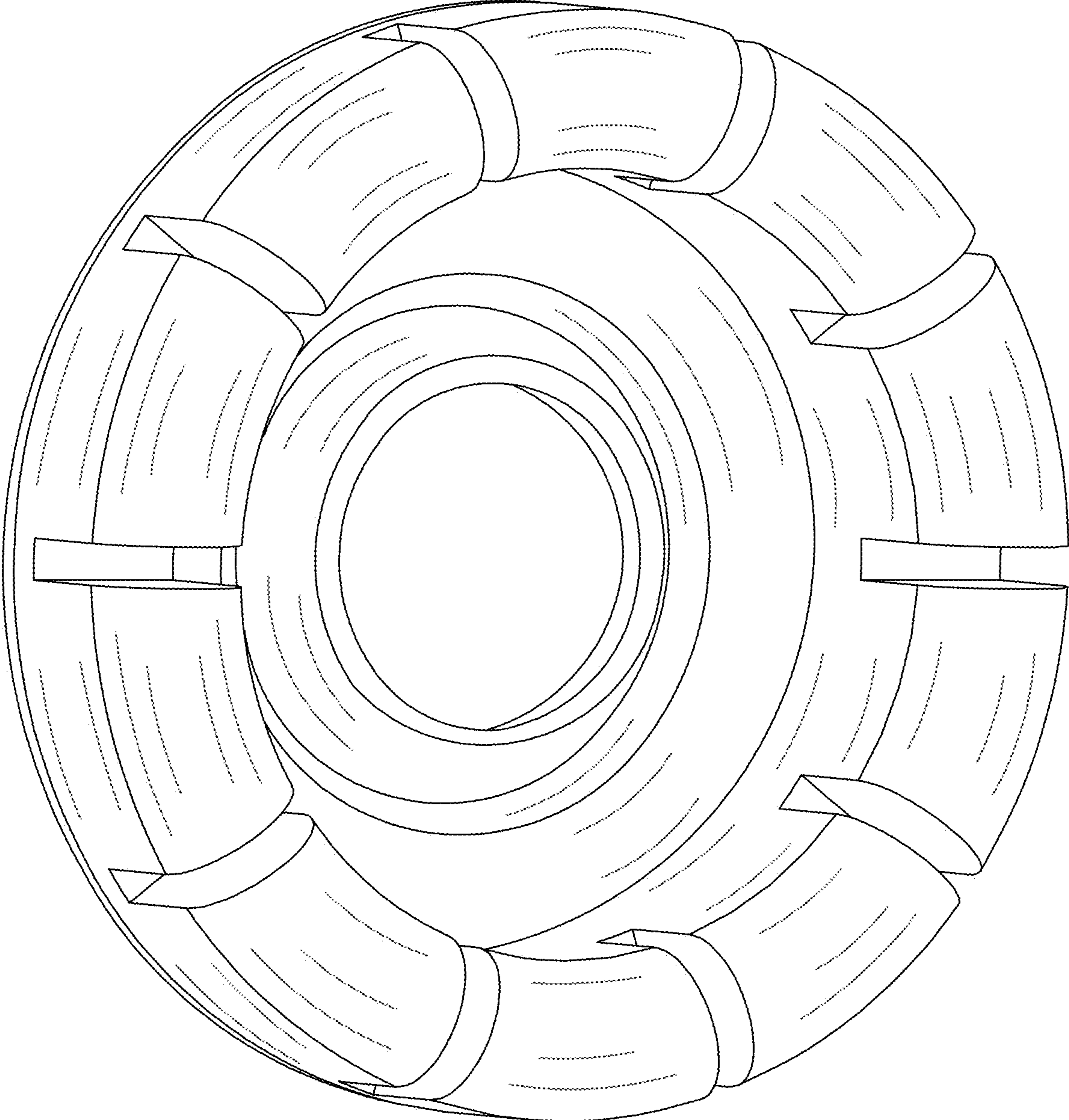

Fig.9

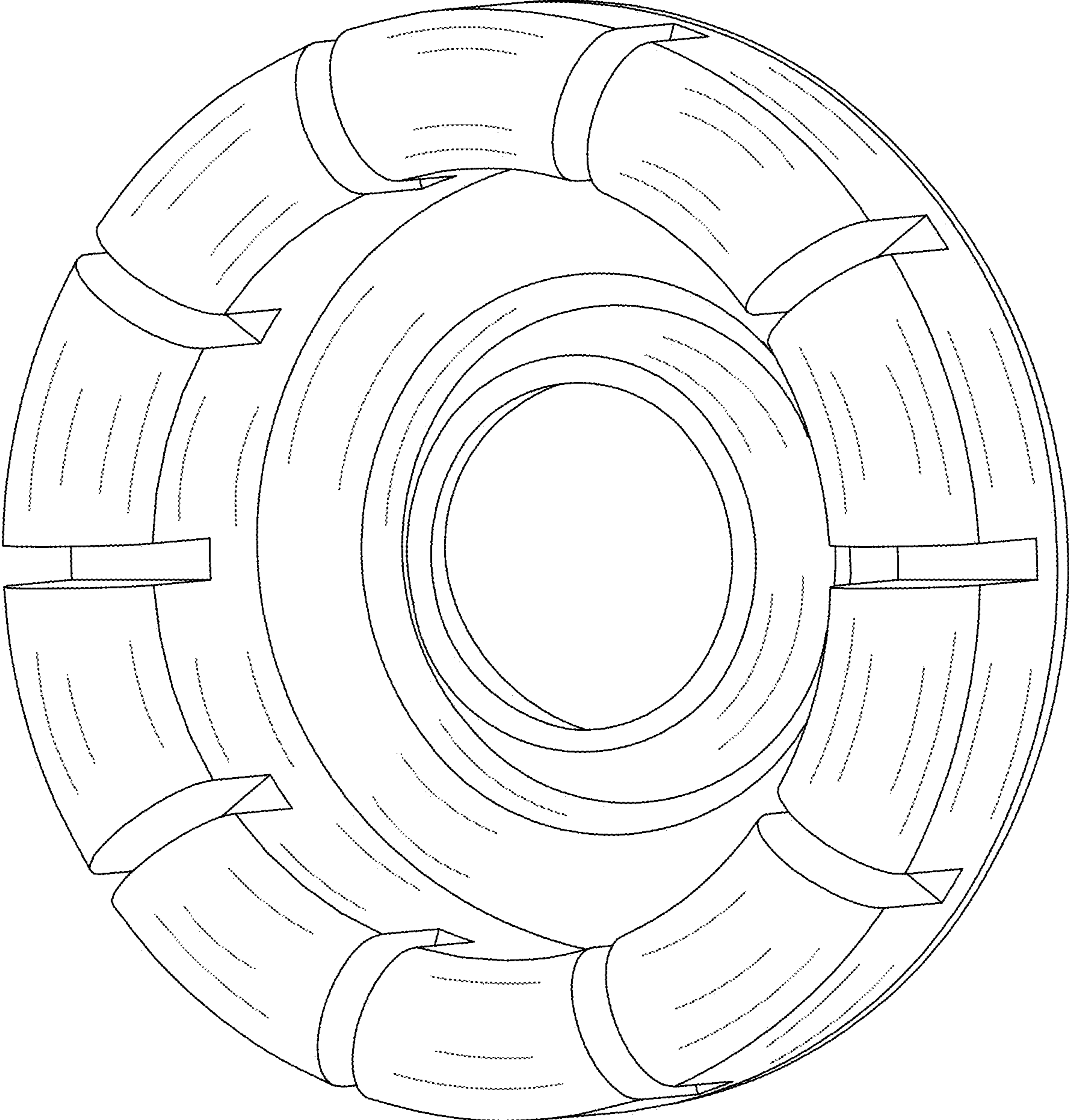

Fig. 10

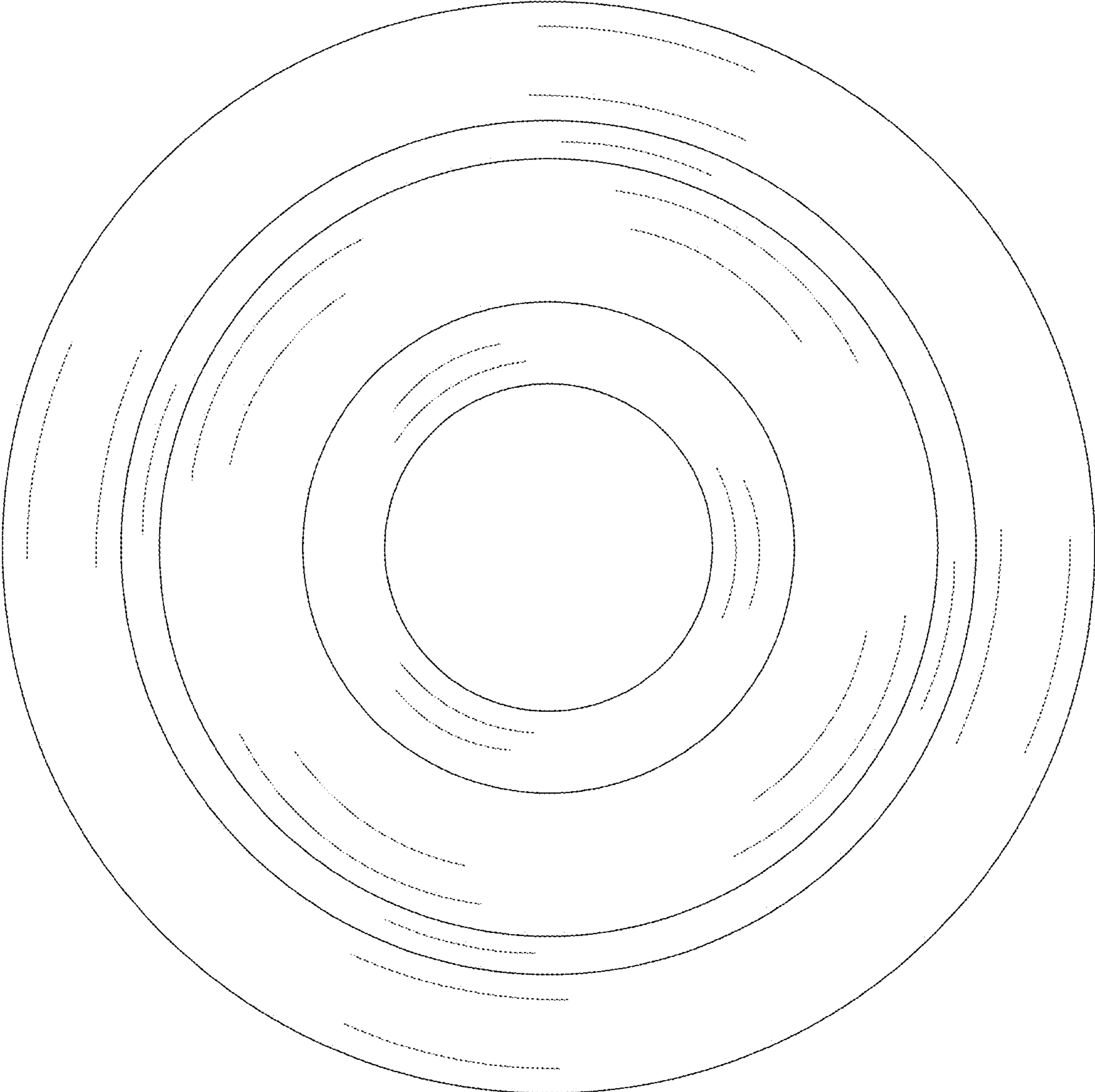

Fig. 11

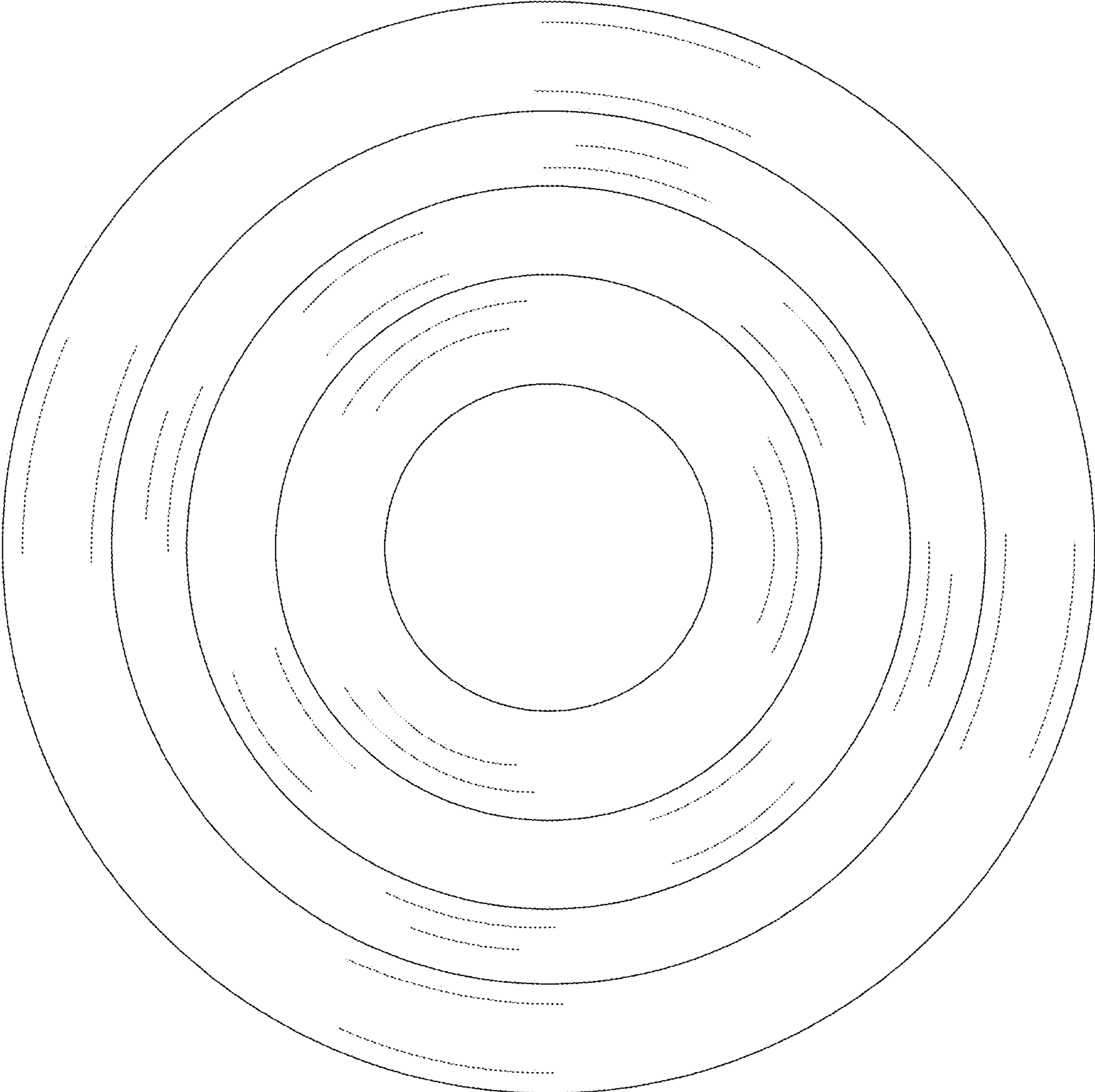

Fig. 12

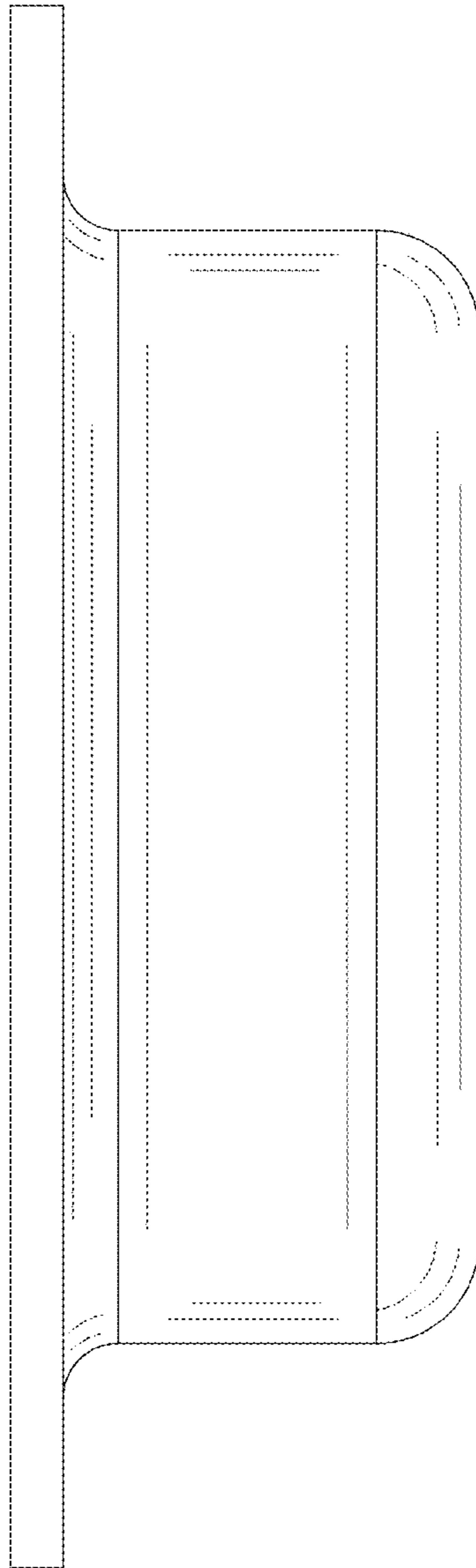

Fig. 13

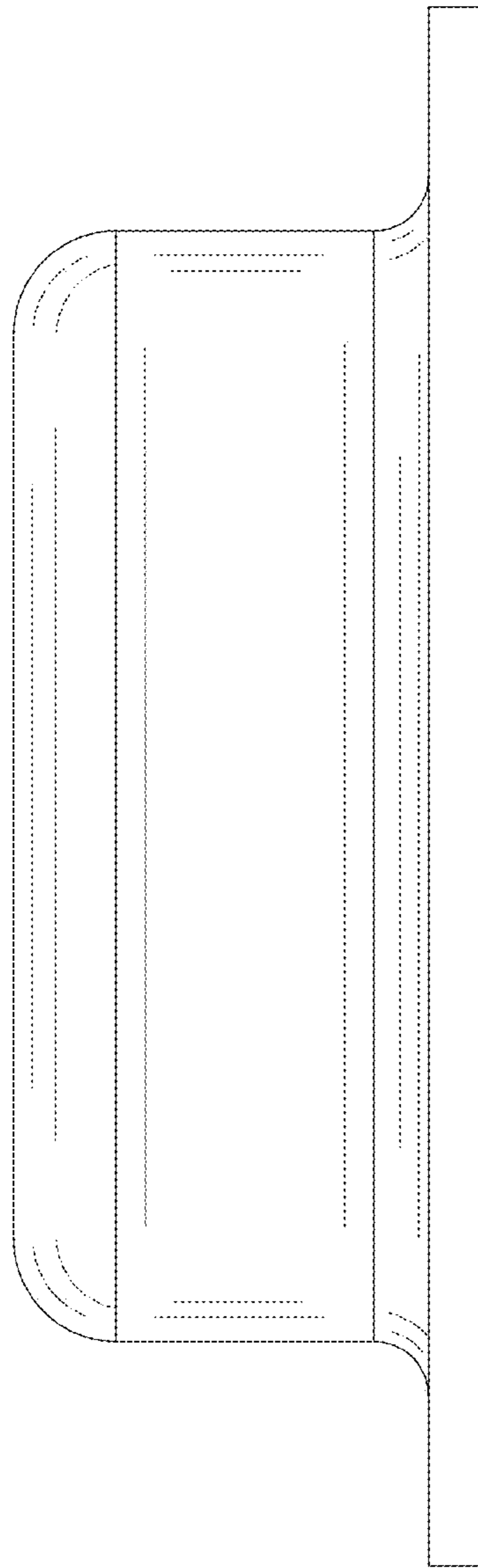

Fig. 14

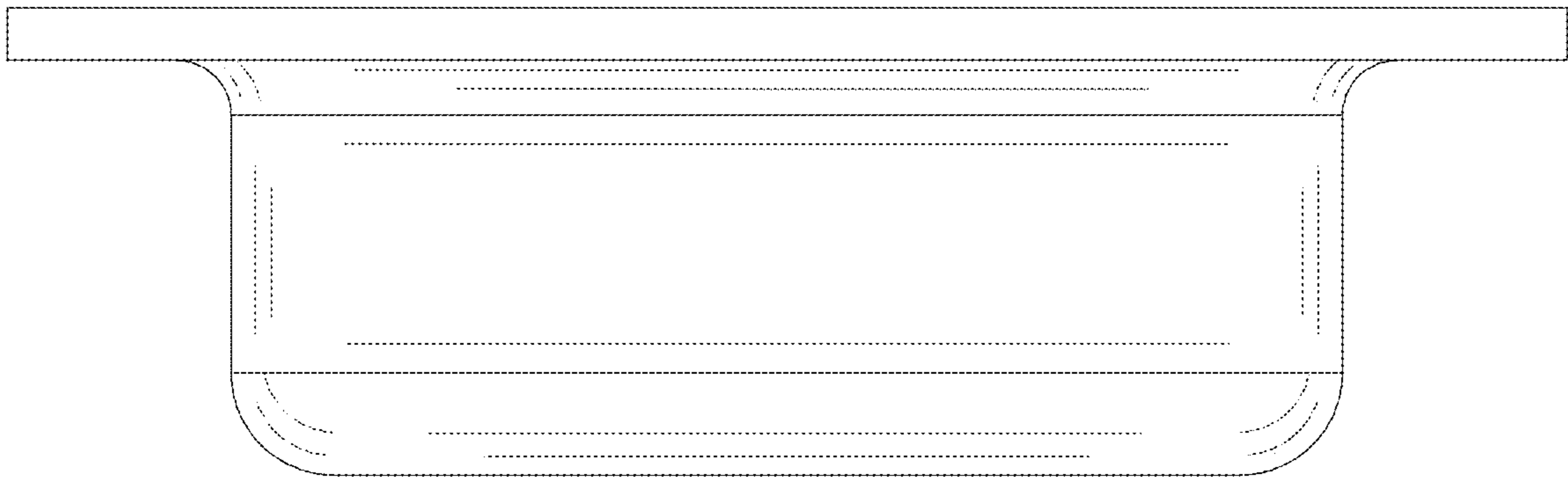

Fig. 15

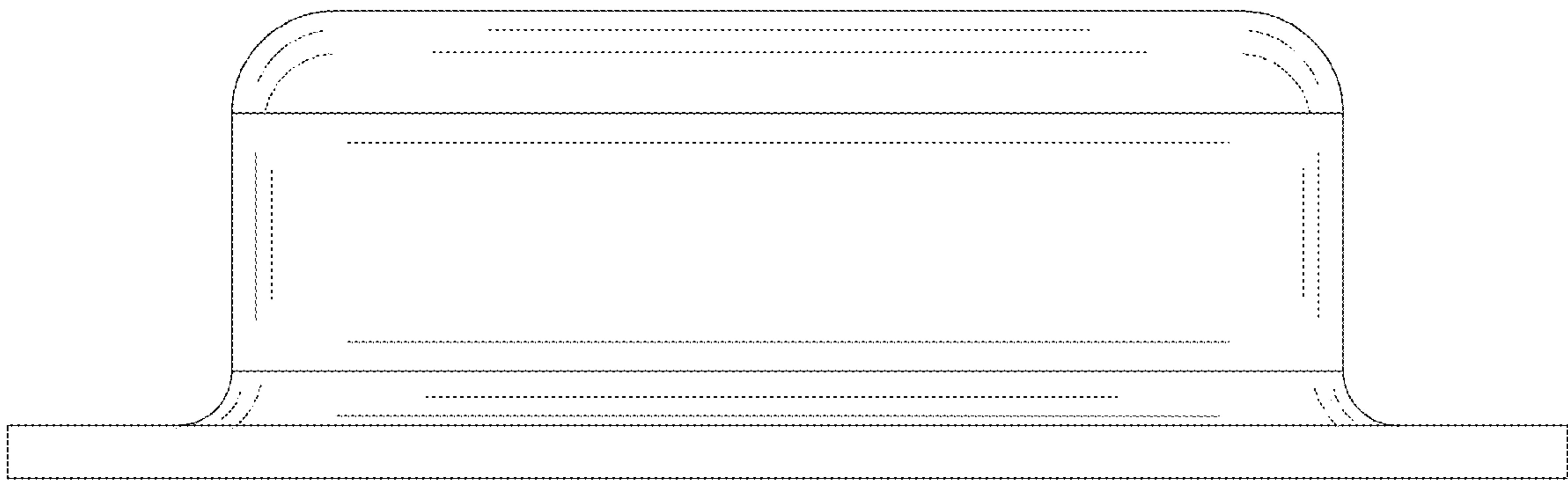

Fig. 16

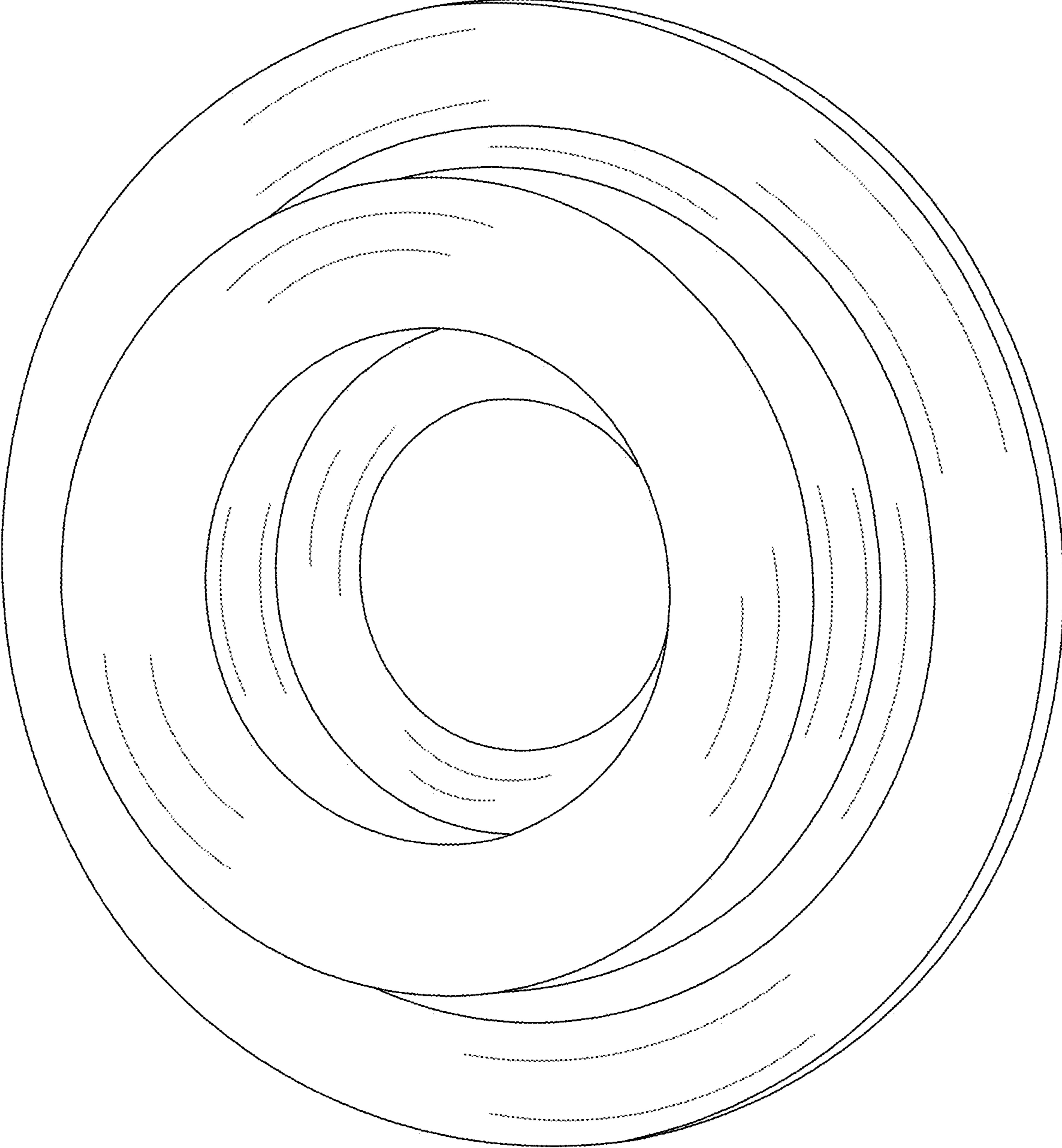

Fig. 17

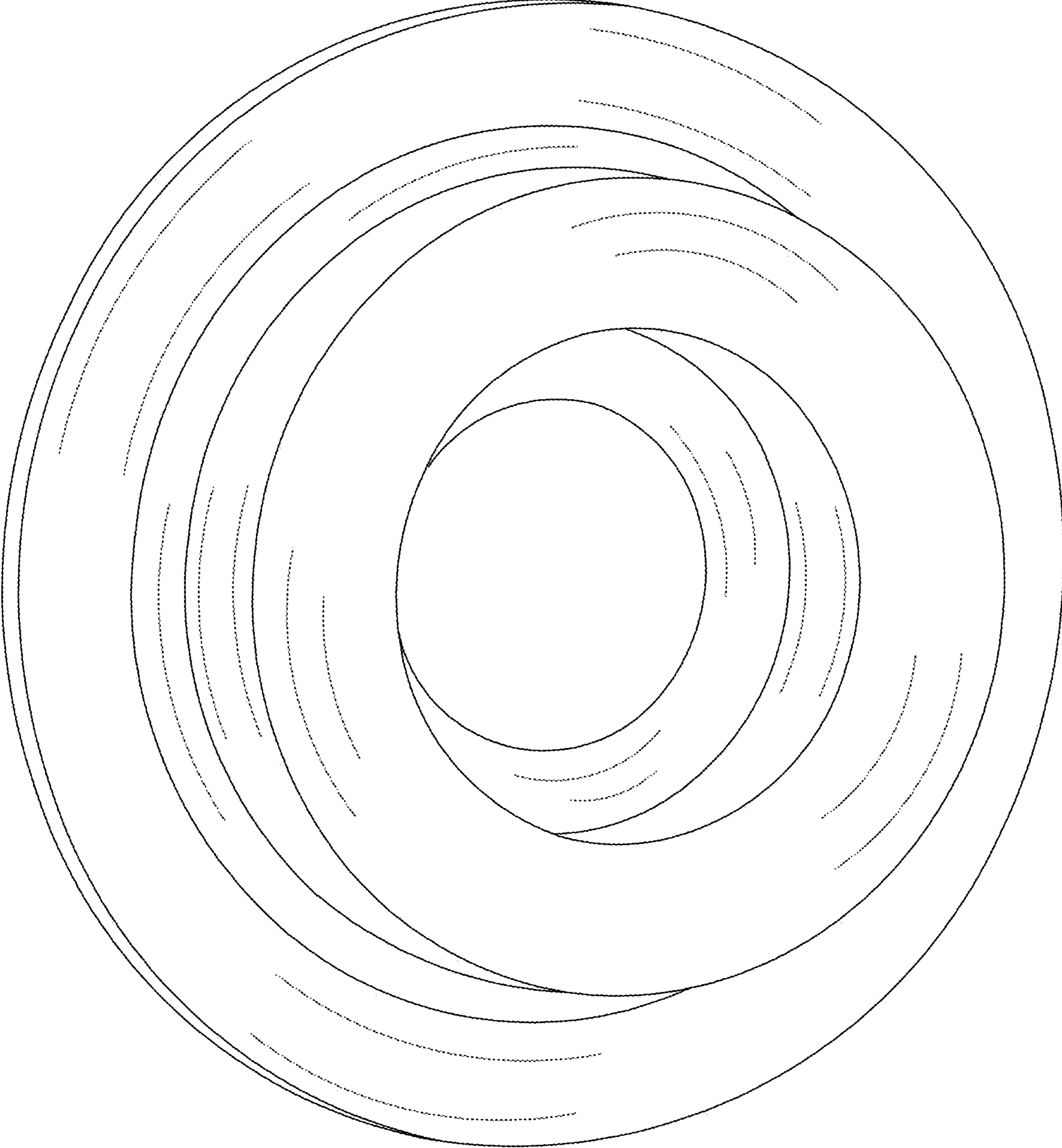

Fig. 18

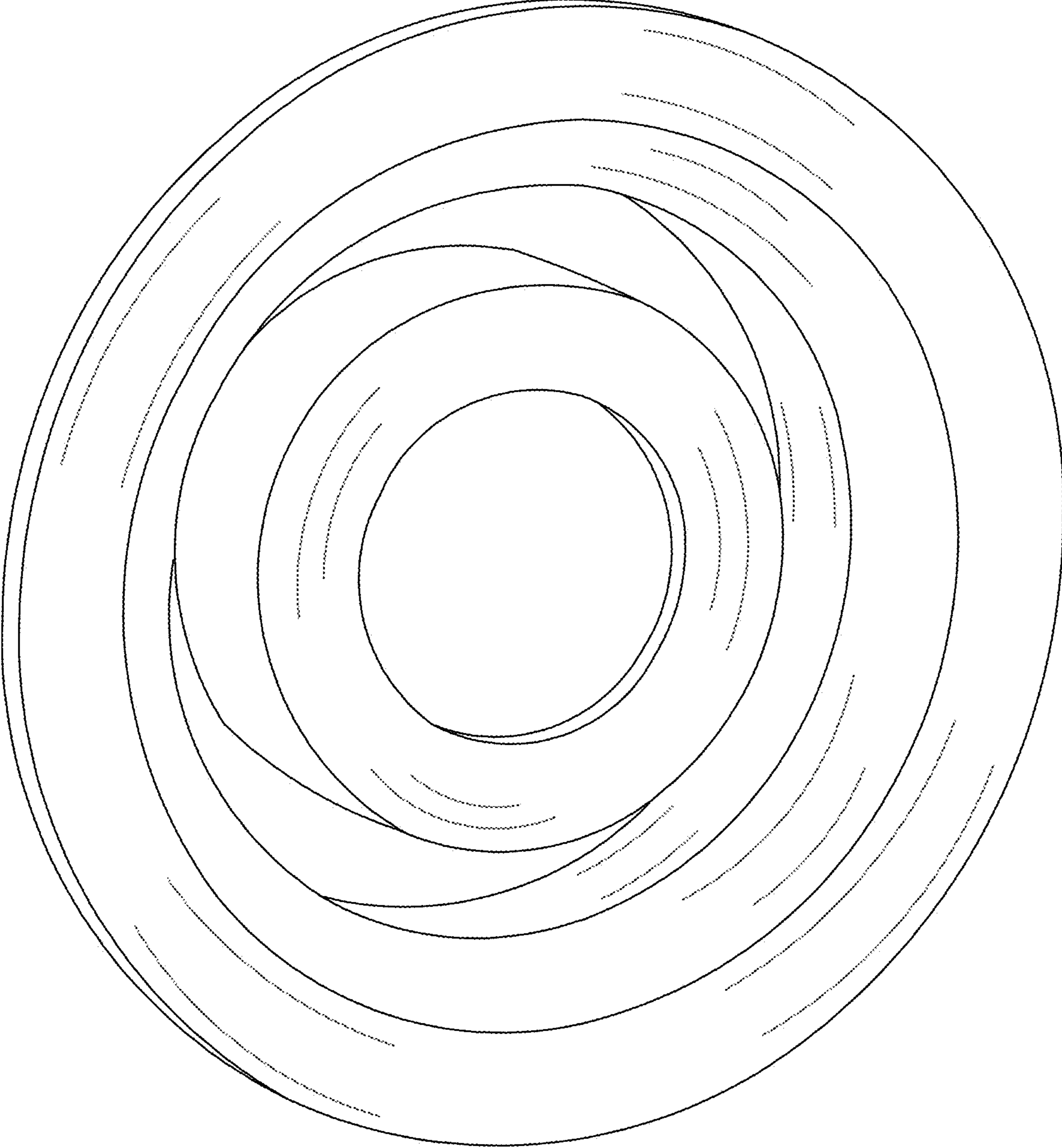

Fig. 19

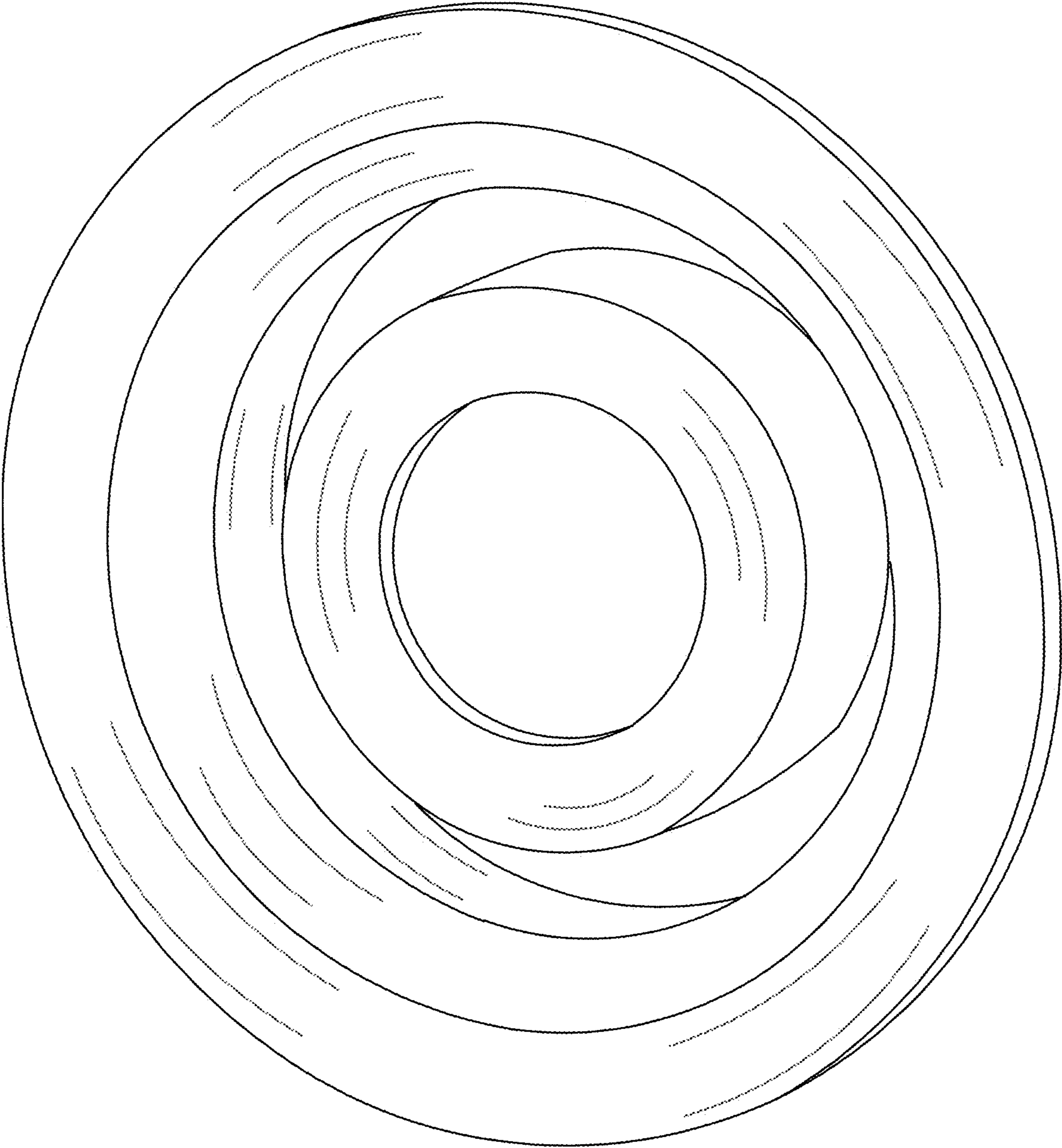

Fig. 20

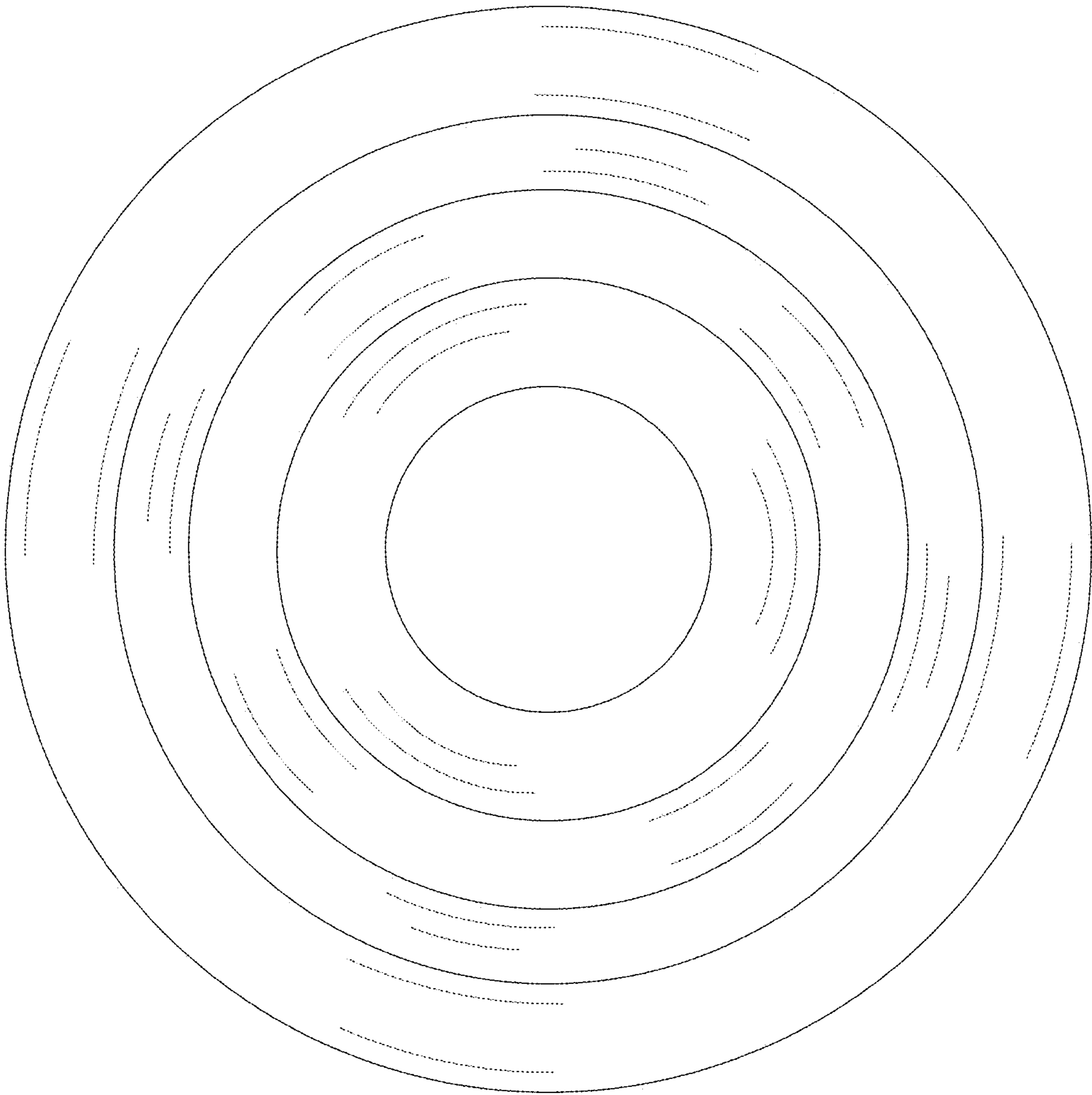

Fig. 21

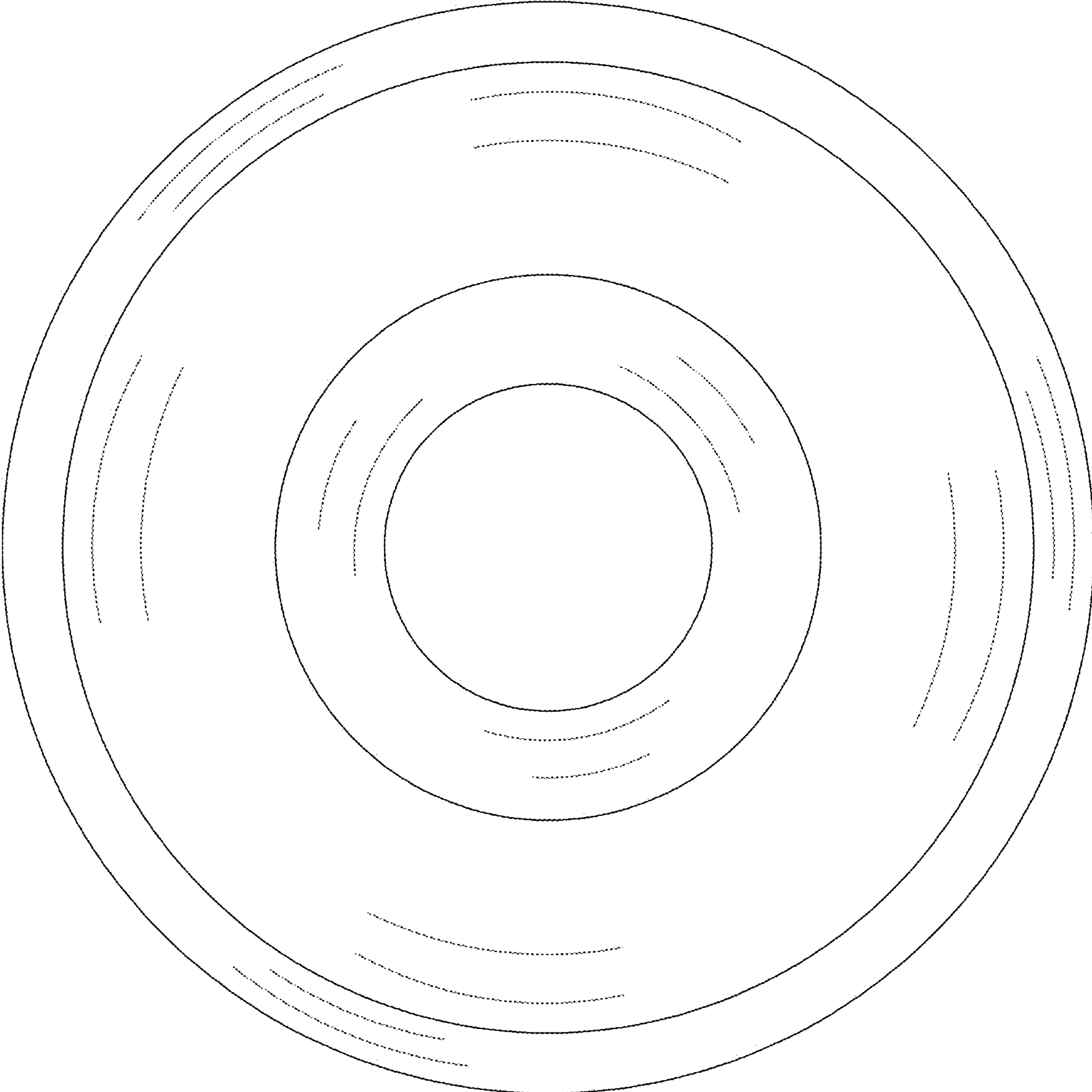

Fig. 22

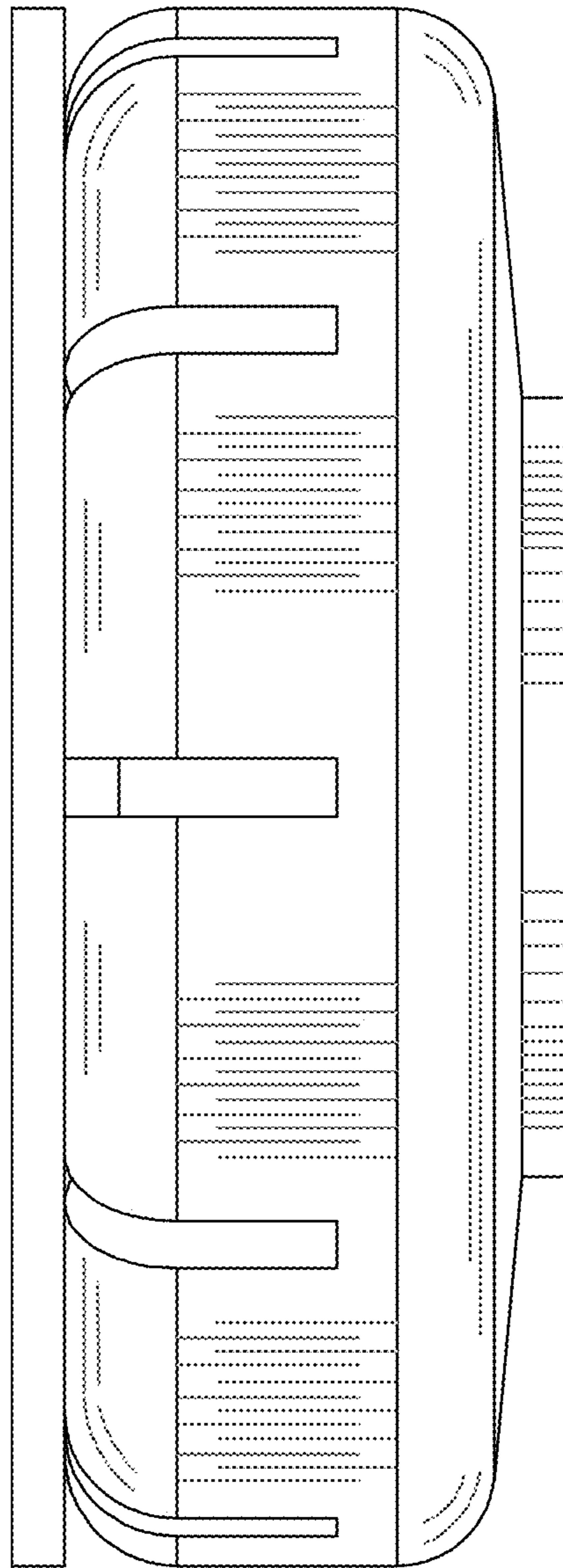

Fig. 23

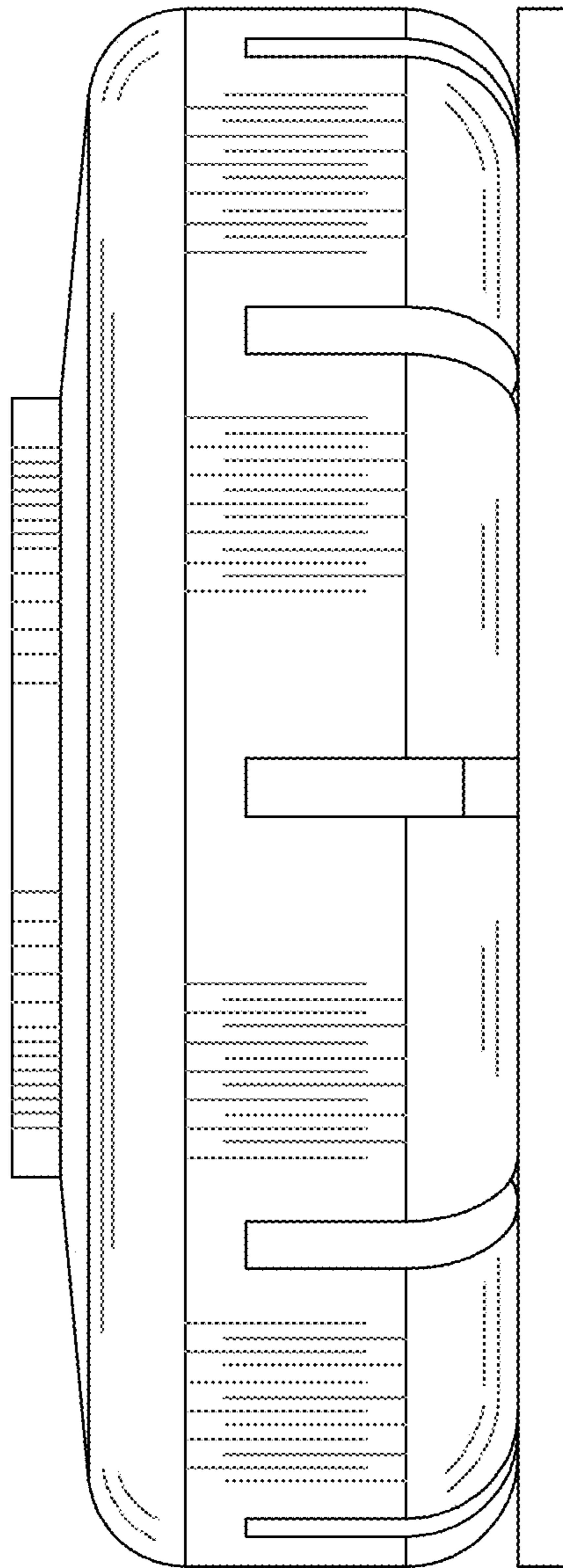

Fig. 24

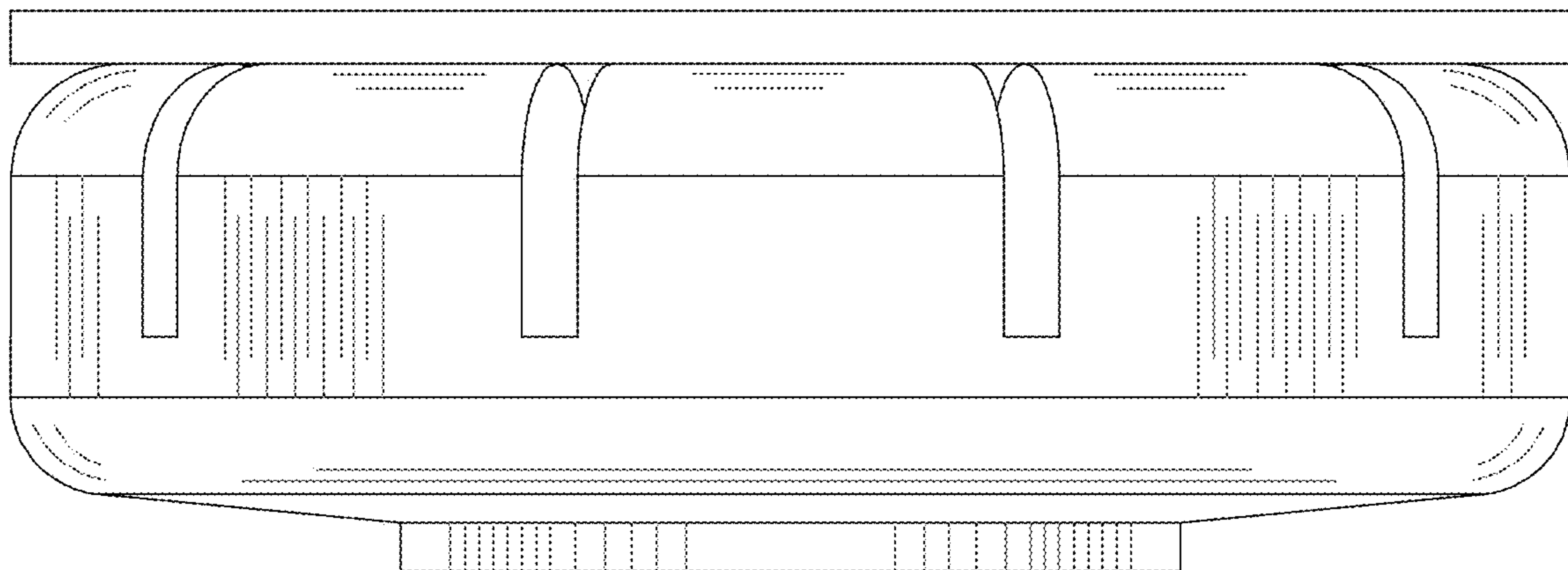

Fig. 25

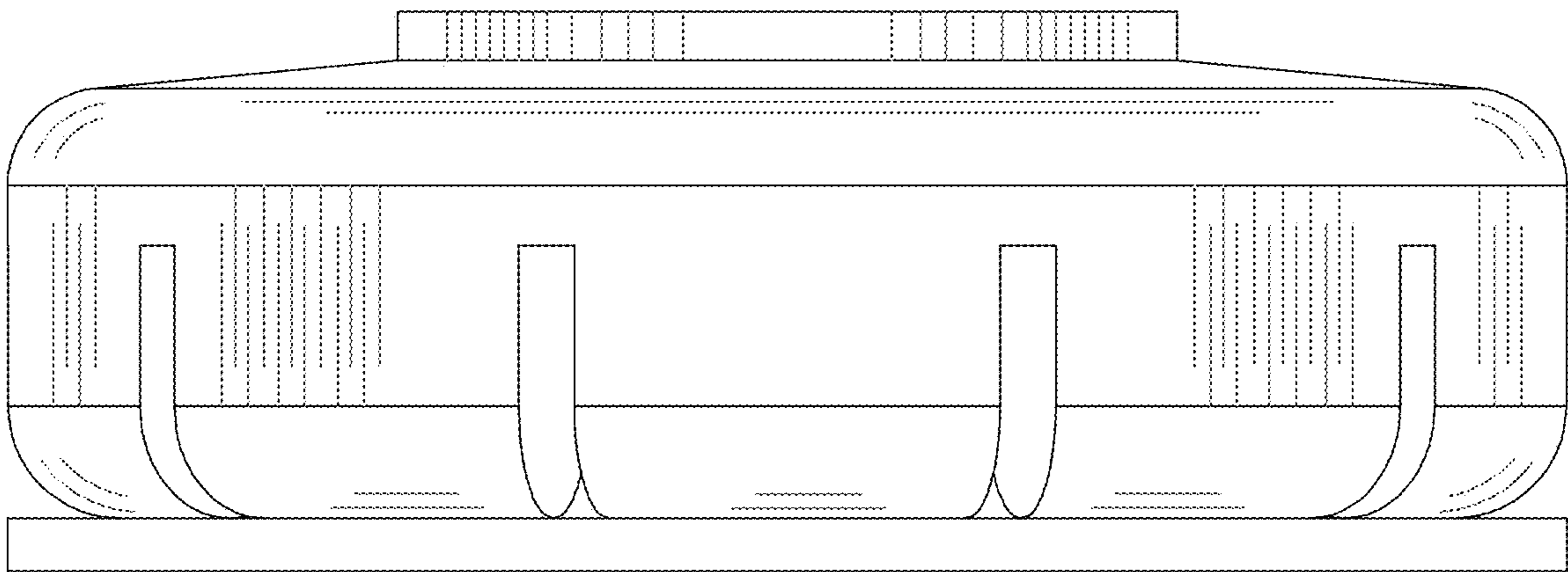

Fig. 26

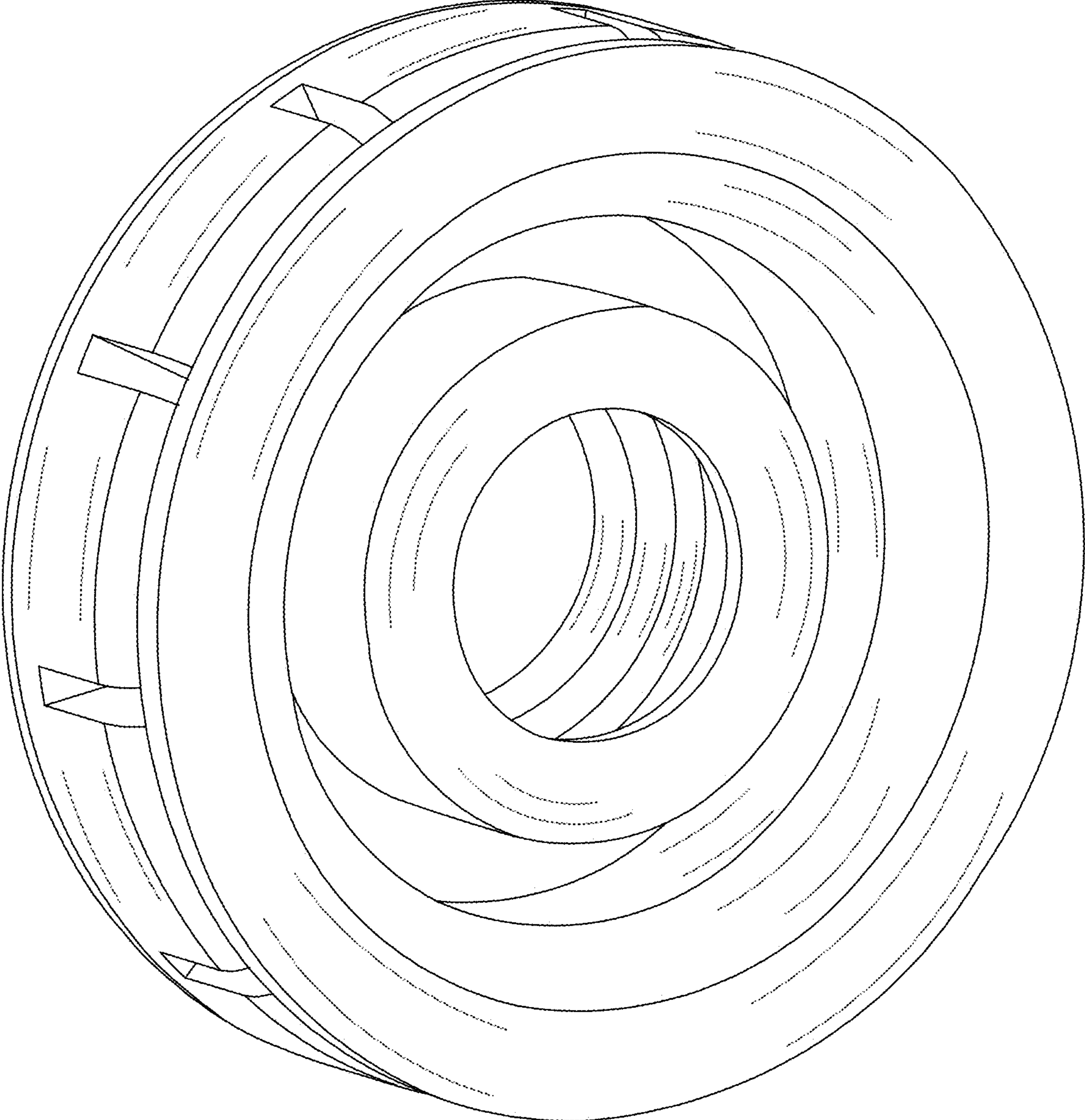

Fig. 27

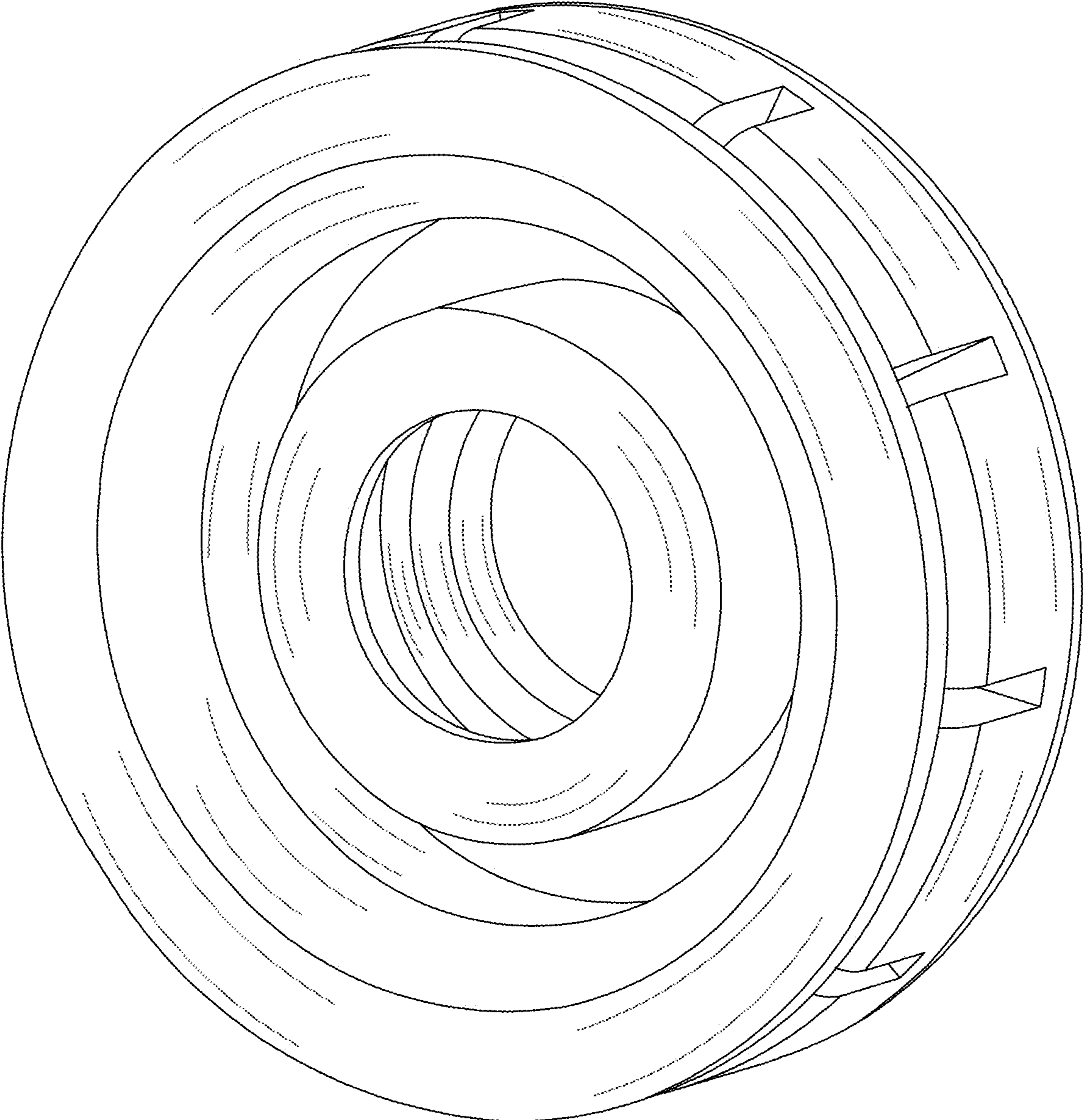

Fig. 28

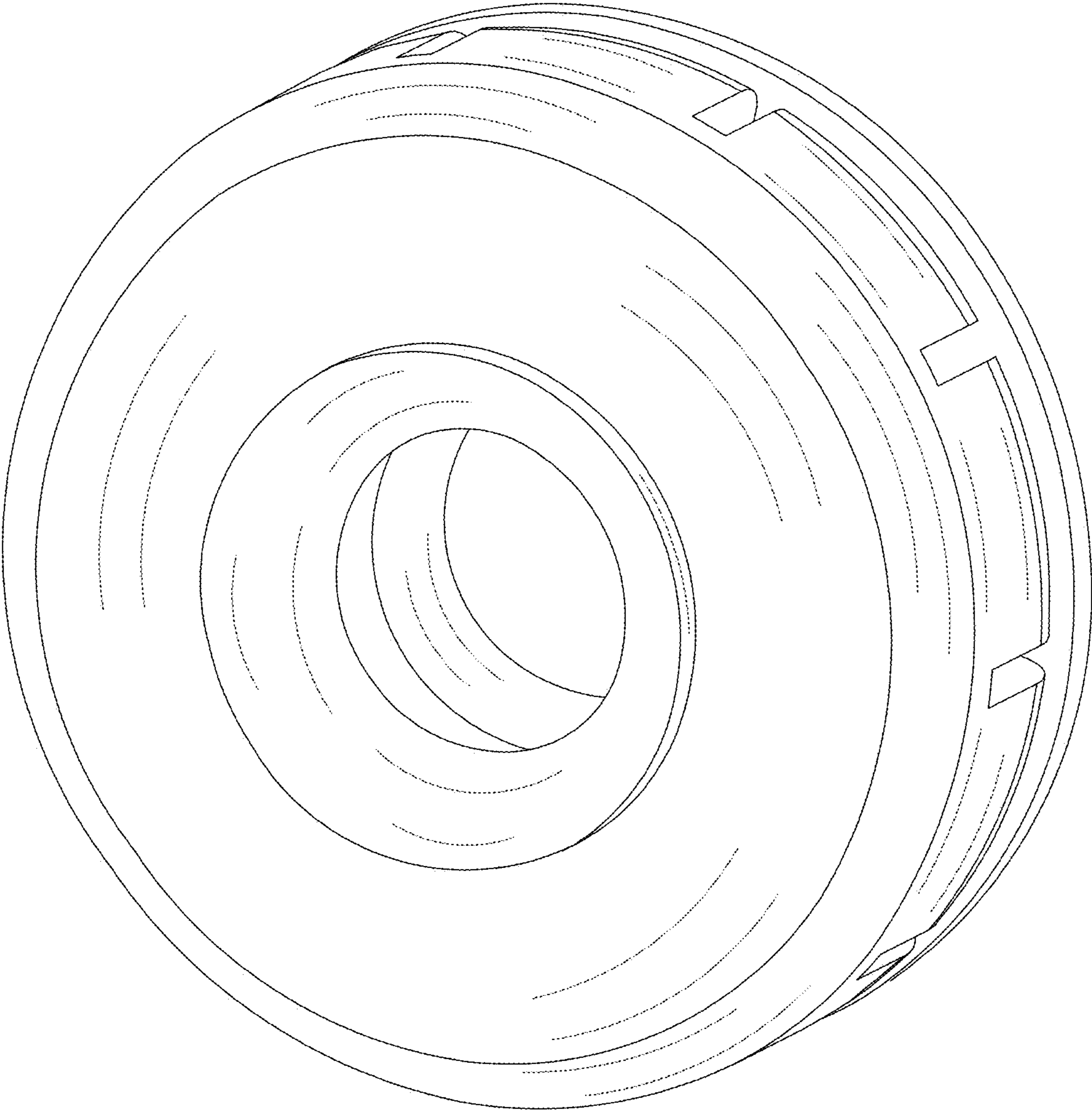

Fig. 29

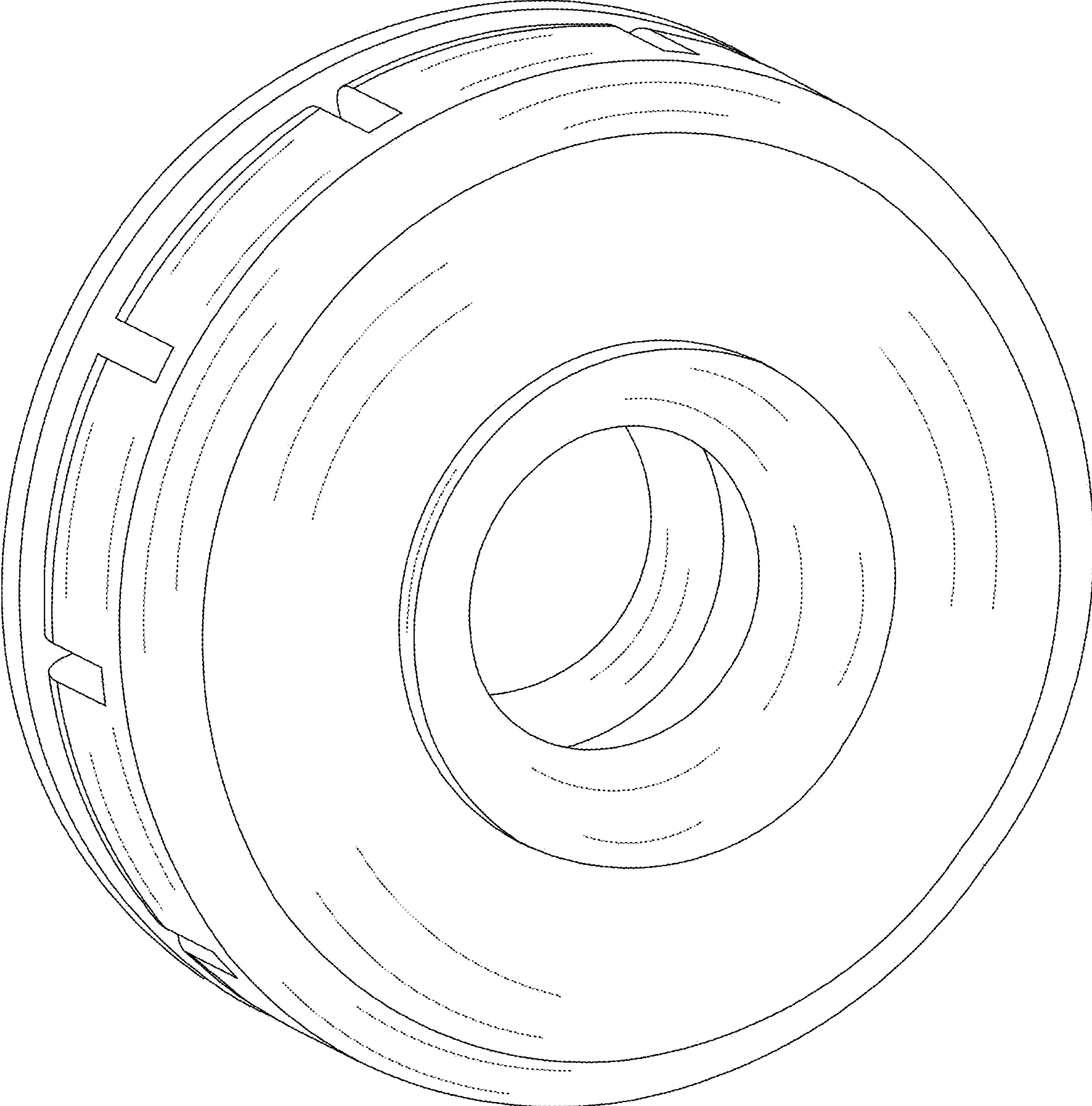

Fig. 30

UNITED STATES PATENT AND TRADEMARK OFFICE
CERTIFICATE OF CORRECTION

PATENT NO. : D899,967 S
APPLICATION NO. : 29/688690
DATED : October 27, 2020
INVENTOR(S) : Man Chak Chan

Page 1 of 1

It is certified that error appears in the above-identified patent and that said Letters Patent is hereby corrected as shown below:

On the Title Page

The following Foreign Application Priority Data was omitted:

October 23, 2018 (CN)..... 201830610589.6

Signed and Sealed this
Second Day of March, 2021



Drew Hirshfeld
*Performing the Functions and Duties of the
Under Secretary of Commerce for Intellectual Property and
Director of the United States Patent and Trademark Office*