



US00D899928S

(12) **United States Design Patent**
Friedman

(10) **Patent No.:** **US D899,928 S**

(45) **Date of Patent:** **** Oct. 27, 2020**

- (54) **BOTTLE CAP**
- (71) Applicant: **Robert Friedman**, Irvine, CA (US)
- (72) Inventor: **Robert Friedman**, Irvine, CA (US)
- (**) Term: **15 Years**
- (21) Appl. No.: **29/690,522**
- (22) Filed: **May 8, 2019**

- 3,567,058 A * 3/1971 Mascia B65D 50/061
215/213
- D276,598 S * 12/1984 Bagwell D9/443
- 4,569,456 A * 2/1986 Weiler B65D 41/58
215/251
- D351,793 S * 10/1994 Stoller D9/443
- D358,329 S * 5/1995 Dickie D9/443
- 5,431,305 A * 7/1995 Kaminski B65D 47/244
222/109
- D367,613 S * 3/1996 Weiler D24/224
- D371,485 S * 7/1996 Hickey D7/391
- D387,552 S * 12/1997 Hayman D3/203.2
- 5,941,404 A * 8/1999 Charrette B65D 41/04
215/305

Related U.S. Application Data

- (62) Division of application No. 29/585,883, filed on Nov. 29, 2016.
- (51) **LOC (12) Cl.** **09-07**
- (52) **U.S. Cl.**
USPC **D9/443**
- (58) **Field of Classification Search**
USPC D9/414, 434-436, 438-440, 443-457,
D9/499, 503-505, 682, 685, 686;
D7/387, 391, 392, 392.1, 396.2-396.4,
D7/401.1, 507, 509-511, 538, 900;
D3/202, 203.2, 318; D28/91.1
CPC .. A61J 1/00; A61J 1/1412; B65D 1/00; B65D
1/02; B65D 1/10; B65D 1/46; B65D
5/46; B65D 41/00; B65D 41/38; B65D
41/56; B65D 41/62; B65D 47/00; B65D
47/06; B65D 47/08; B65D 2251/00;
B65D 2543/00046; B65D 2543/00092;
B65D 2543/00296; B65D 2585/56; B65D
2585/545
See application file for complete search history.

(56) **References Cited**

U.S. PATENT DOCUMENTS

- 1,665,602 A * 4/1928 Netherland B65D 41/0442
215/302
- 3,045,860 A * 7/1962 Desgagne B65D 51/04
220/254.3

(Continued)

Primary Examiner — Michael A. Pratt
Assistant Examiner — Wendy L Arminio
 (74) *Attorney, Agent, or Firm* — Fish IP Law, LLP

(57) **CLAIM**

The ornamental design for a bottle cap, as shown and described.

DESCRIPTION

FIG. 1 is a perspective view of a first embodiment of a bottle cap, shown in a position of use on a bottle drawn in broken lines.

FIG. 2 is a top view of the bottle cap of FIG. 1, shown removed from the bottle.

FIG. 3 is a side view thereof.

FIG. 4 is a front view thereof.

FIG. 5 is a perspective view of a second embodiment of the bottle cap, shown in a position of use on a bottle drawn in broken lines.

FIG. 6 is a top view of the bottle cap of FIG. 5, shown removed from the bottle.

FIG. 7 is a side view thereof; and,

FIG. 8 is a front view thereof.

The broken lines depict environment and form no part of the claimed design.

1 Claim, 2 Drawing Sheets

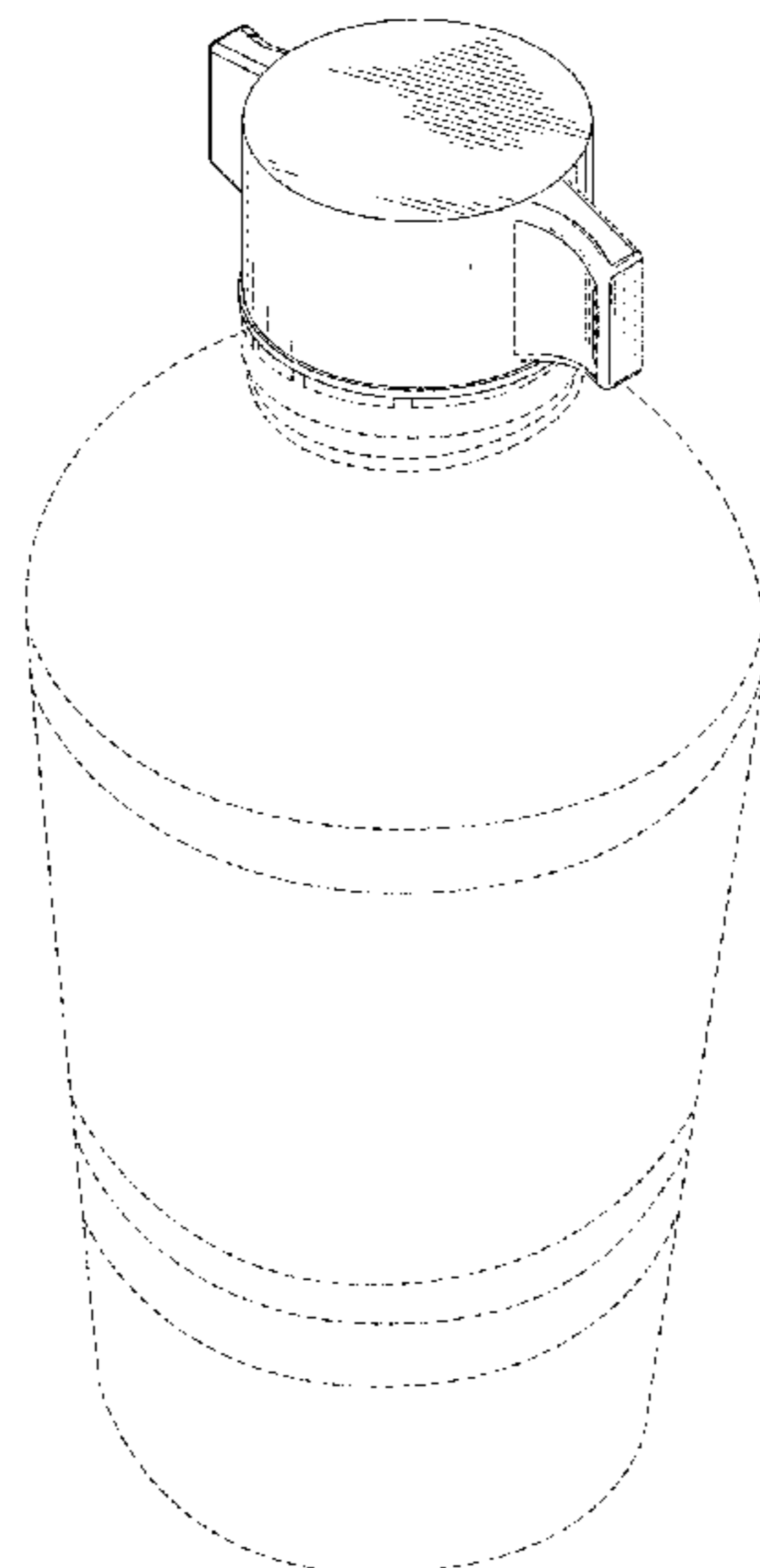

(56)

References Cited

U.S. PATENT DOCUMENTS

6,253,942	B1 *	7/2001	Elias	B65D 41/0485 215/305
D472,145	S *	3/2003	Nottingham	D9/443
D480,973	S *	10/2003	Nottingham	D9/531
D482,974	S *	12/2003	Nottingham	D9/531
D482,975	S *	12/2003	Nottingham	D9/532
D511,100	S *	11/2005	Nottingham	D9/528
D594,750	S *	6/2009	Westphal	D9/443
D621,705	S *	8/2010	Breckan	D9/443
D621,706	S *	8/2010	Breckan	D9/443
D621,707	S *	8/2010	Breckan	D9/443
D623,533	S *	9/2010	Nakamura	D9/443
D630,043	S *	1/2011	Taggart	D7/392
D636,264	S *	4/2011	Wassum	D9/453
D640,552	S *	6/2011	Eiteljorg	D9/443
D640,553	S *	6/2011	Eiteljorg	D9/443
D695,511	S *	12/2013	Sharpe	D3/203.2
D715,147	S *	10/2014	Ginzburg	D9/449
D727,726	S *	4/2015	Friedman	D9/443
D739,204	S *	9/2015	Arthurs	D8/307
D746,149	S *	12/2015	Ginzburg	D9/574
D751,384	S *	3/2016	Torrison	D9/416
D756,774	S *	5/2016	McWilliams	D9/443
D777,342	S *	1/2017	Piramoone	D24/224
D779,324	S *	2/2017	Martini	D9/443
9,650,179	B2 *	5/2017	Sheikh	B65D 33/16
D829,098	S *	9/2018	Gallagher	D9/443
D833,869	S *	11/2018	Kropf	D9/443

* cited by examiner

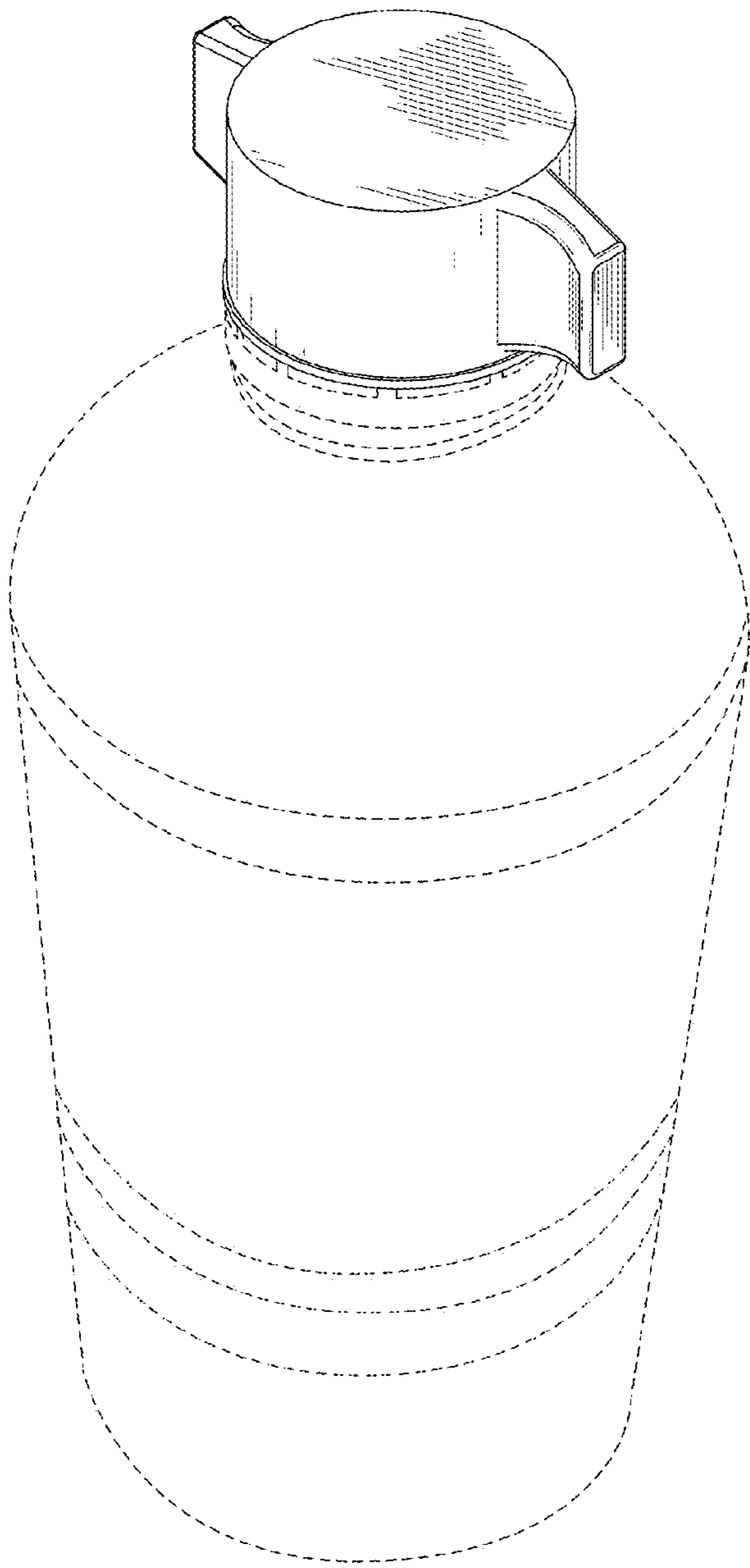

FIG. 1

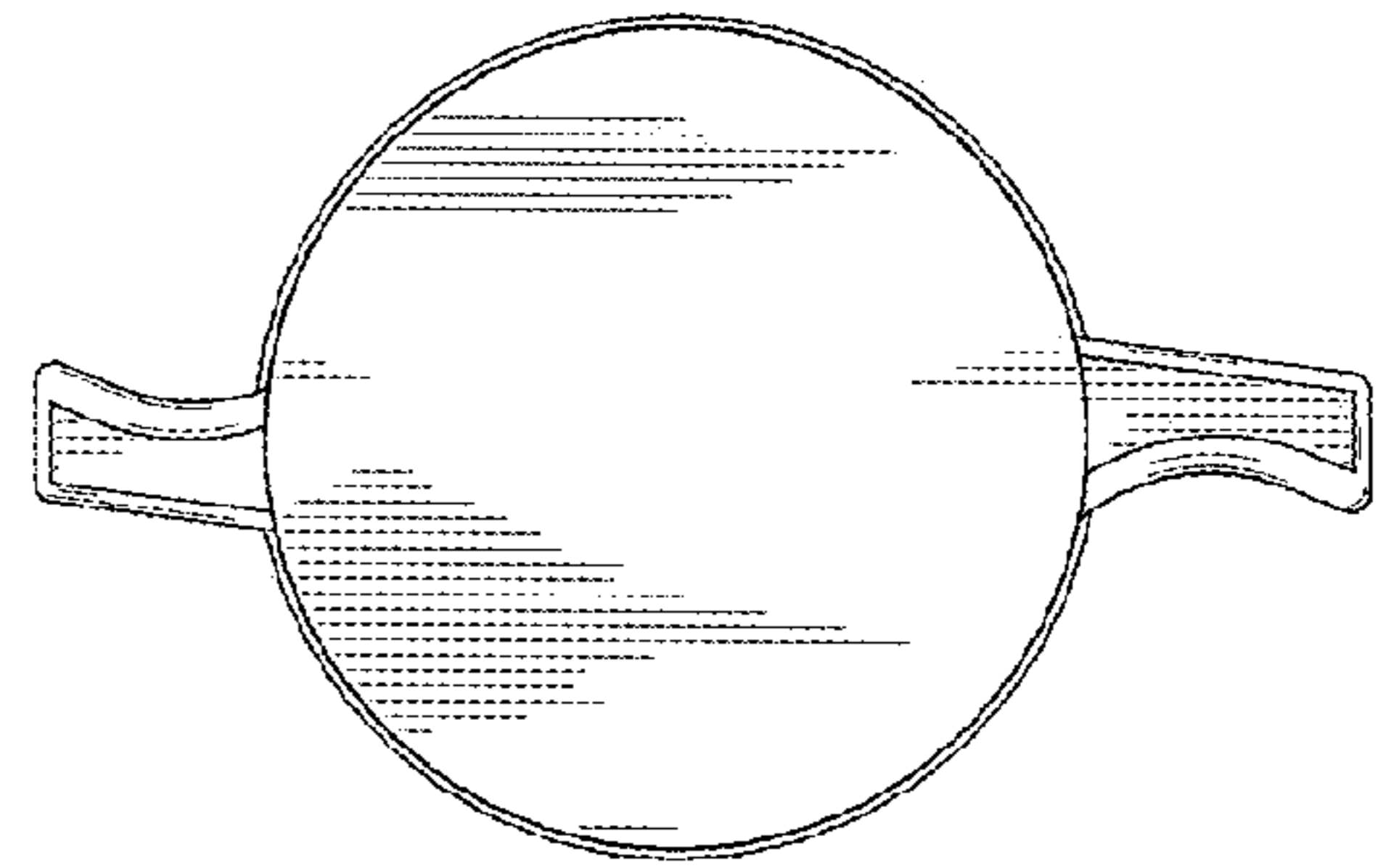

FIG. 2

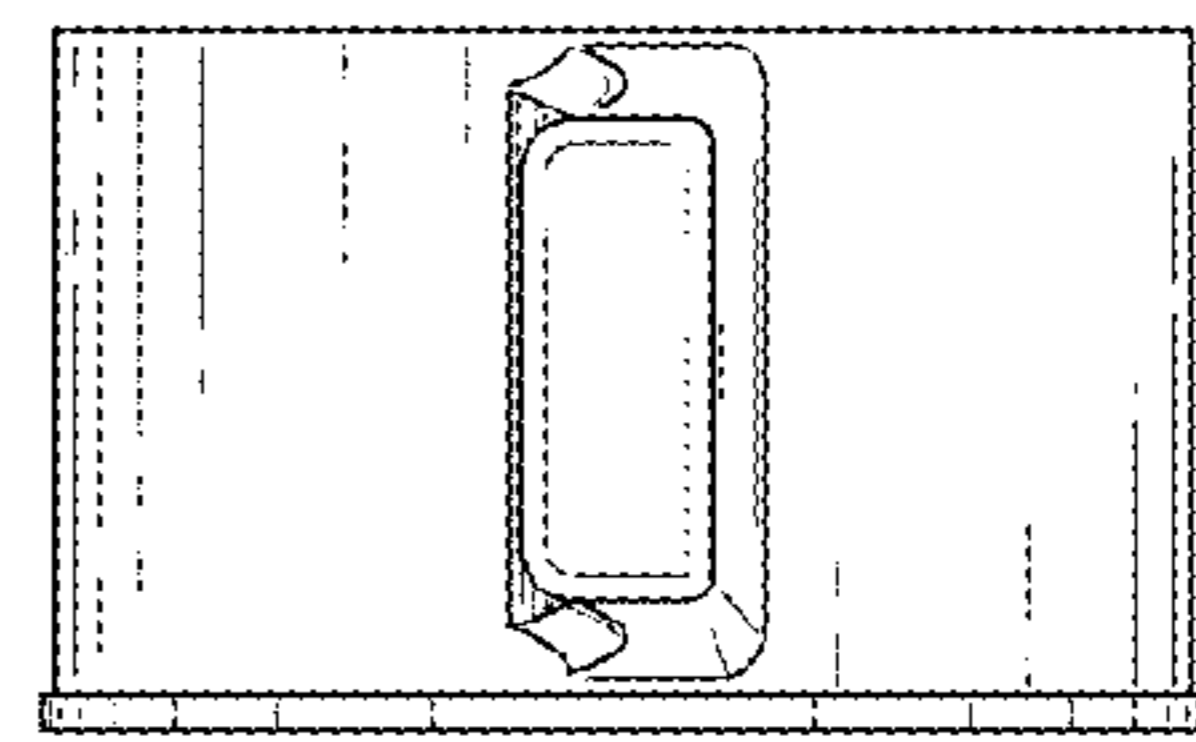

FIG. 3

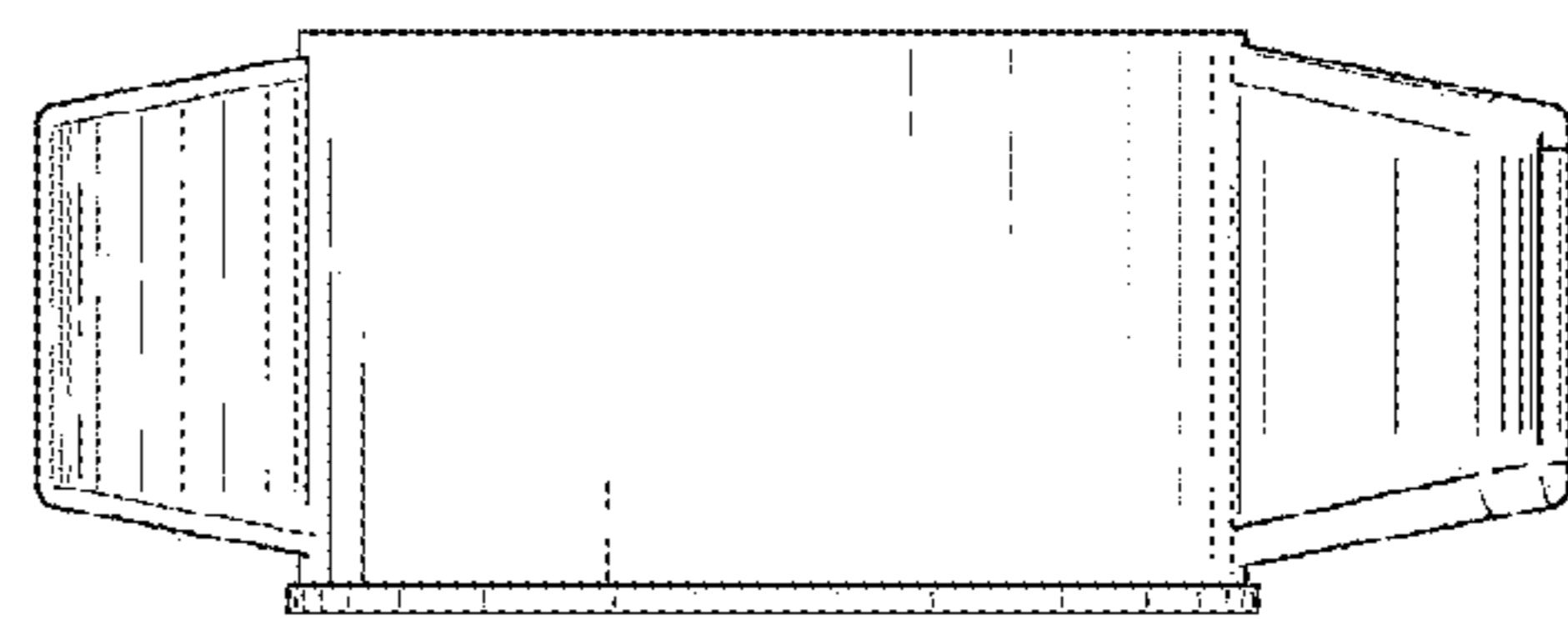

FIG. 4

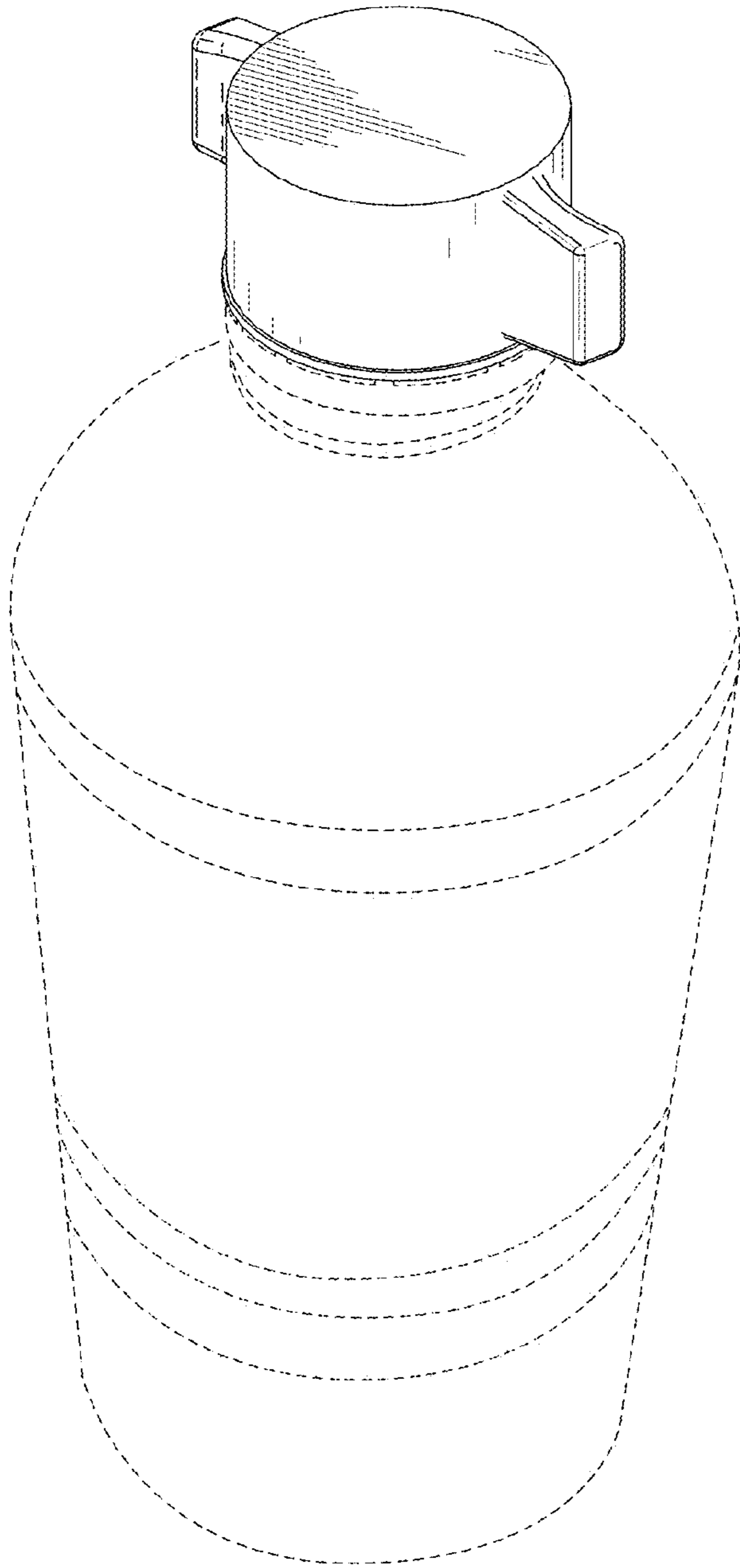

FIG. 5

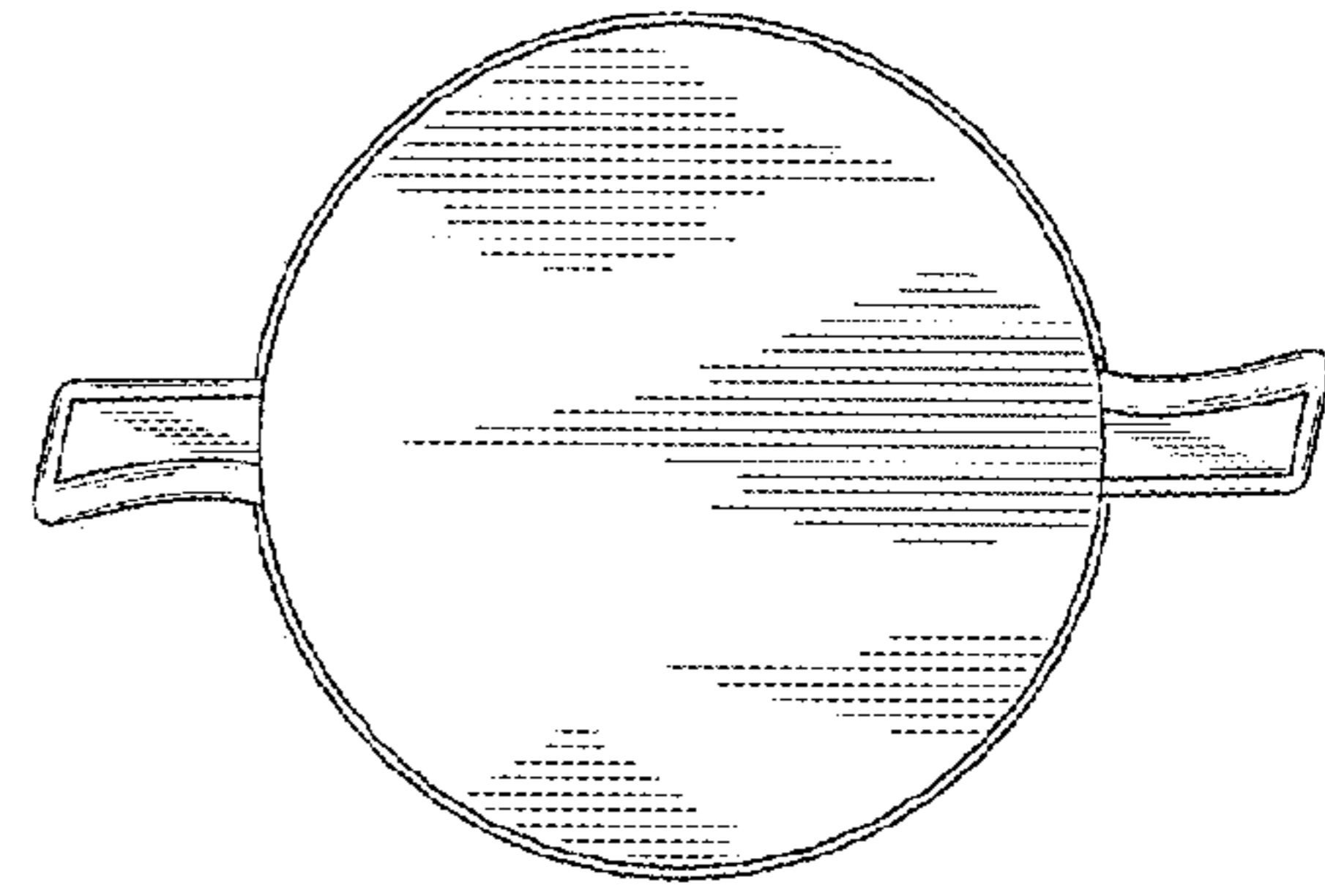

FIG. 6

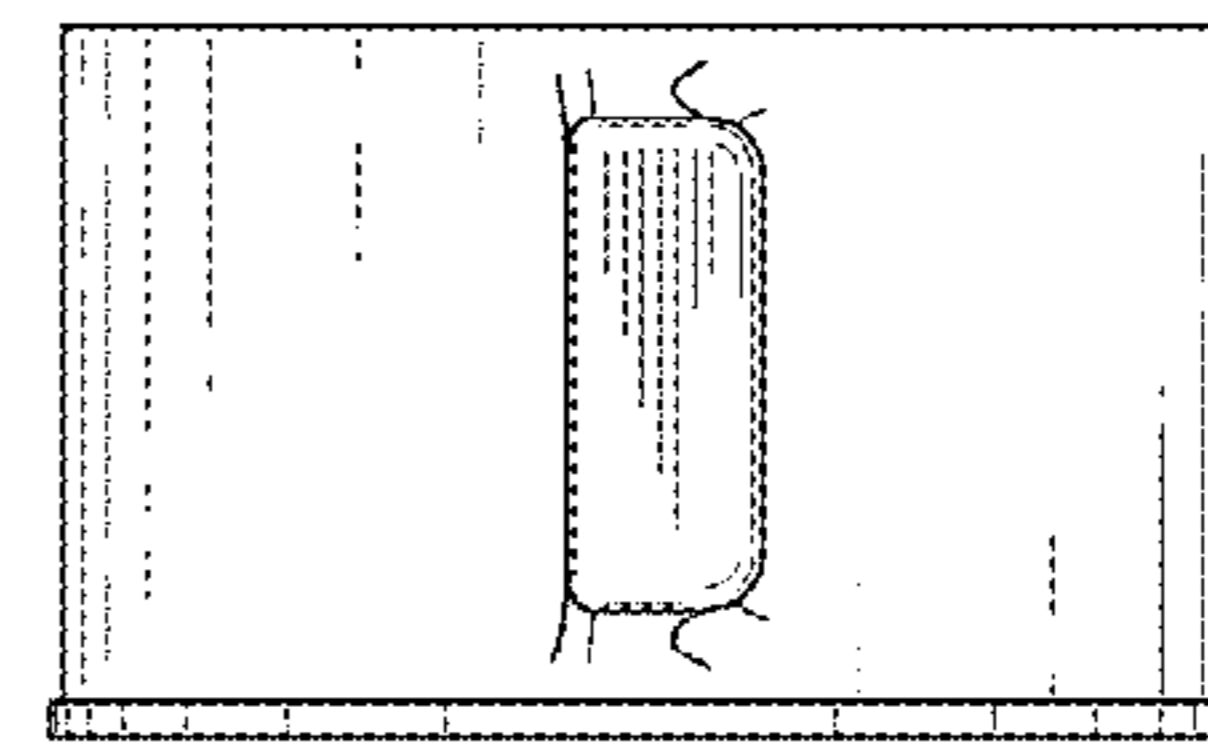

FIG. 7

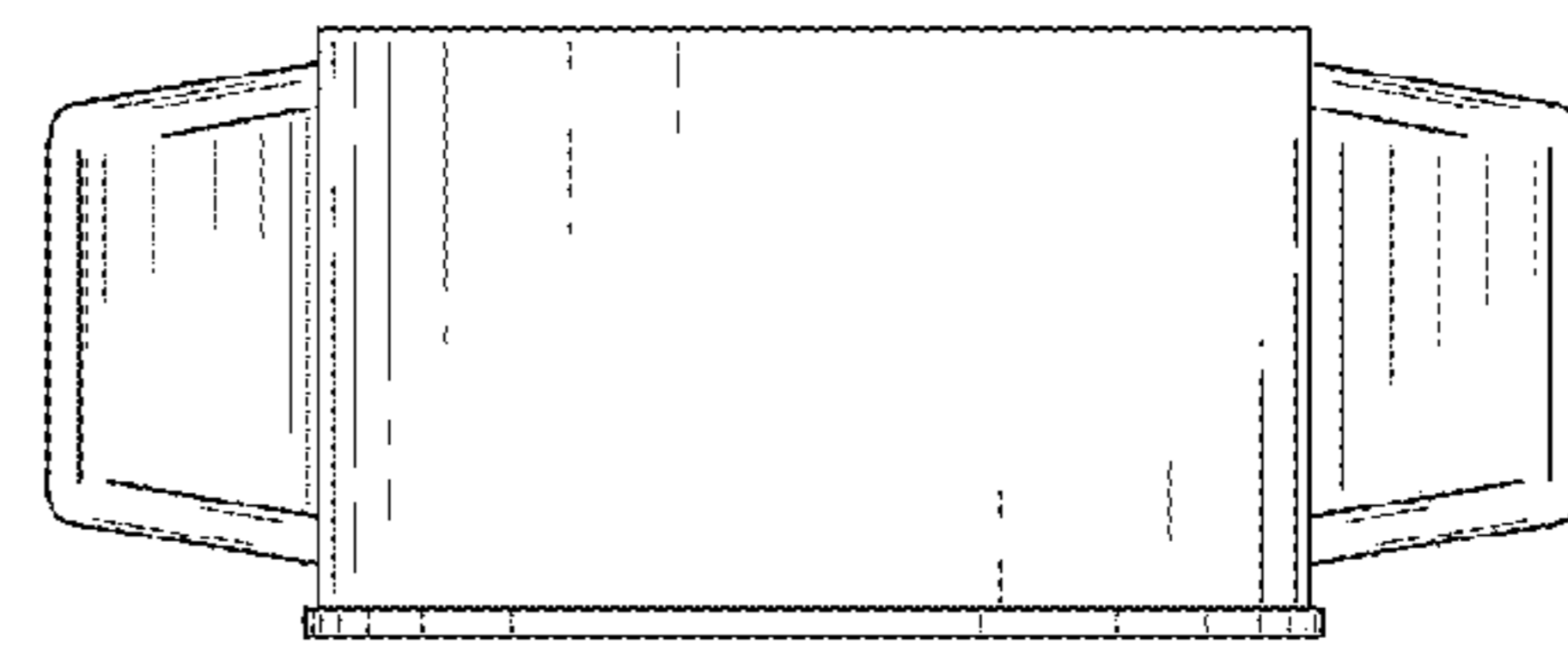

FIG. 8