



US00D899874S

(12) **United States Design Patent**
Lane et al.

(10) **Patent No.:** **US D899,874 S**
(45) **Date of Patent:** **** Oct. 27, 2020**

(54) **FOOD JAR**

DESCRIPTION

- (71) Applicant: **Thermos L.L.C.**, Schaumburg, IL (US)
- (72) Inventors: **Marvin Lane**, Wheeling, IL (US);
Dwayne Boroski, Lake in the Hills, IL (US);
Freddy Aranda, Chicago, IL (US);
Jennifer Bae Park, Chicago, IL (US)
- (73) Assignee: **THERMOS L.L.C.**, Schaumburg
- (**) Term: **15 Years**
- (21) Appl. No.: **29/726,818**
- (22) Filed: **Mar. 5, 2020**

Related U.S. Application Data

- (62) Division of application No. 29/643,597, filed on Apr. 10, 2018.
- (51) **LOC (12) Cl.** **09-07**
- (52) **U.S. Cl.**
USPC **D7/629**; D9/516; D9/549; D9/569
- (58) **Field of Classification Search**
USPC D7/509–511, 538, 601, 602, 619.1, 629;
D9/516, 523, 549, 434, 447, 455, 569
(Continued)

(56) **References Cited**

U.S. PATENT DOCUMENTS

- 6,257,432 B1 * 7/2001 Ekkert B65D 41/0421
215/331
- D466,814 S * 12/2002 Hurlburt D9/504
(Continued)

Primary Examiner — Susan E Krakower
Assistant Examiner — Andrew Kerr
(74) *Attorney, Agent, or Firm* — Polsinelli PC

(57) **CLAIM**

The ornamental design for a food jar, as shown and described.

FIG. 1 is a perspective view of a first embodiment of a food jar, showing our new design;
 FIG. 2 is lower perspective view of the first embodiment of the food jar;
 FIG. 3 is a front view of the first embodiment of the food jar;
 FIG. 4 is a right side view of the first embodiment of the food jar;
 FIG. 5 is a rear view of the first embodiment of the food jar;
 FIG. 6 is a left side view of the first embodiment of the food jar;
 FIG. 7 is a top view of the first embodiment of the food jar;
 FIG. 8 is a bottom view of the first embodiment of the food jar;
 FIG. 9 is a perspective view of a second embodiment of a food jar, showing our new design;
 FIG. 10 is lower perspective view of the second embodiment of the food jar;
 FIG. 11 is a front view of the second embodiment of the food jar;
 FIG. 12 is a right side view of the second embodiment of the food jar;
 FIG. 13 is a rear view of the second embodiment of the food jar;
 FIG. 14 is a left side view of the second embodiment of the food jar;
 FIG. 15 is a top view of the second embodiment of the food jar; and,
 FIG. 16 is a bottom view of the second embodiment of the food jar.

The broken lines showing in the figures are included for the purpose of illustrating portions of the food jar that form no part of the claimed design. The dash-dot lines showing in the figures are included for defining the bounds of the claimed design that form no part thereof.

The food jar is shown with a symbolic break in its length. The appearance of any portion of the article between the breakaway lines forms no part of the claimed design.

1 Claim, 14 Drawing Sheets

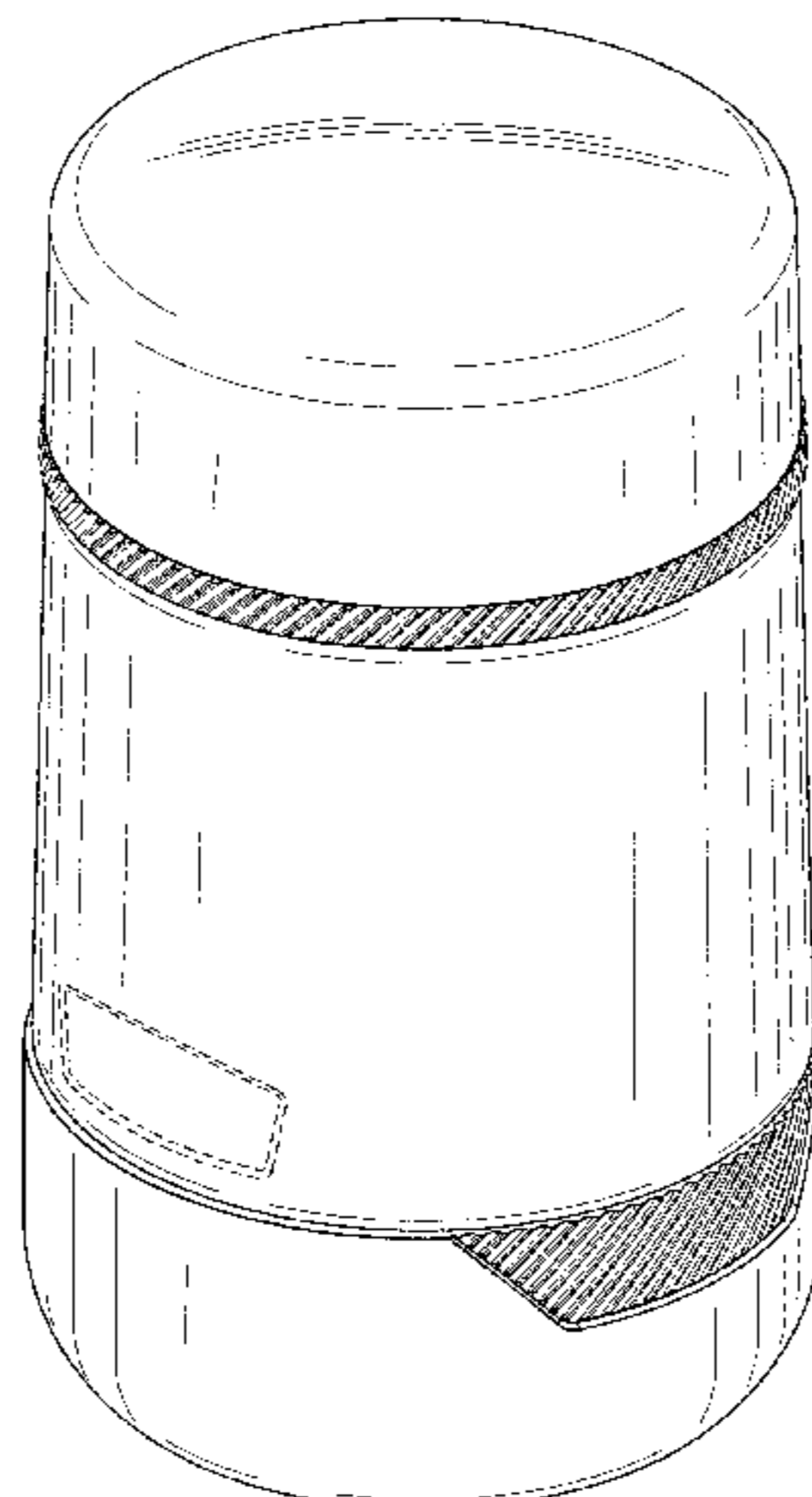

(58) **Field of Classification Search**

CPC A47G 19/2266; A47G 19/2272; A47G
19/22; B65D 25/40; B65D 25/42; B65D
41/04; B65D 41/0485

See application file for complete search history.

(56) **References Cited**

U.S. PATENT DOCUMENTS

D488,961	S	*	4/2004	Moran	D7/608
D557,994	S	*	12/2007	Wahl	D7/608
D593,811	S	*	6/2009	Carreno	D7/608
D599,168	S	*	9/2009	Alviar	D7/510
D636,683	S	*	4/2011	Floyd	D9/688
D728,376	S	*	5/2015	Floyd	D9/692
D782,880	S	*	4/2017	Matsuo	D7/605
D799,908	S	*	10/2017	Seiders	D7/608

* cited by examiner

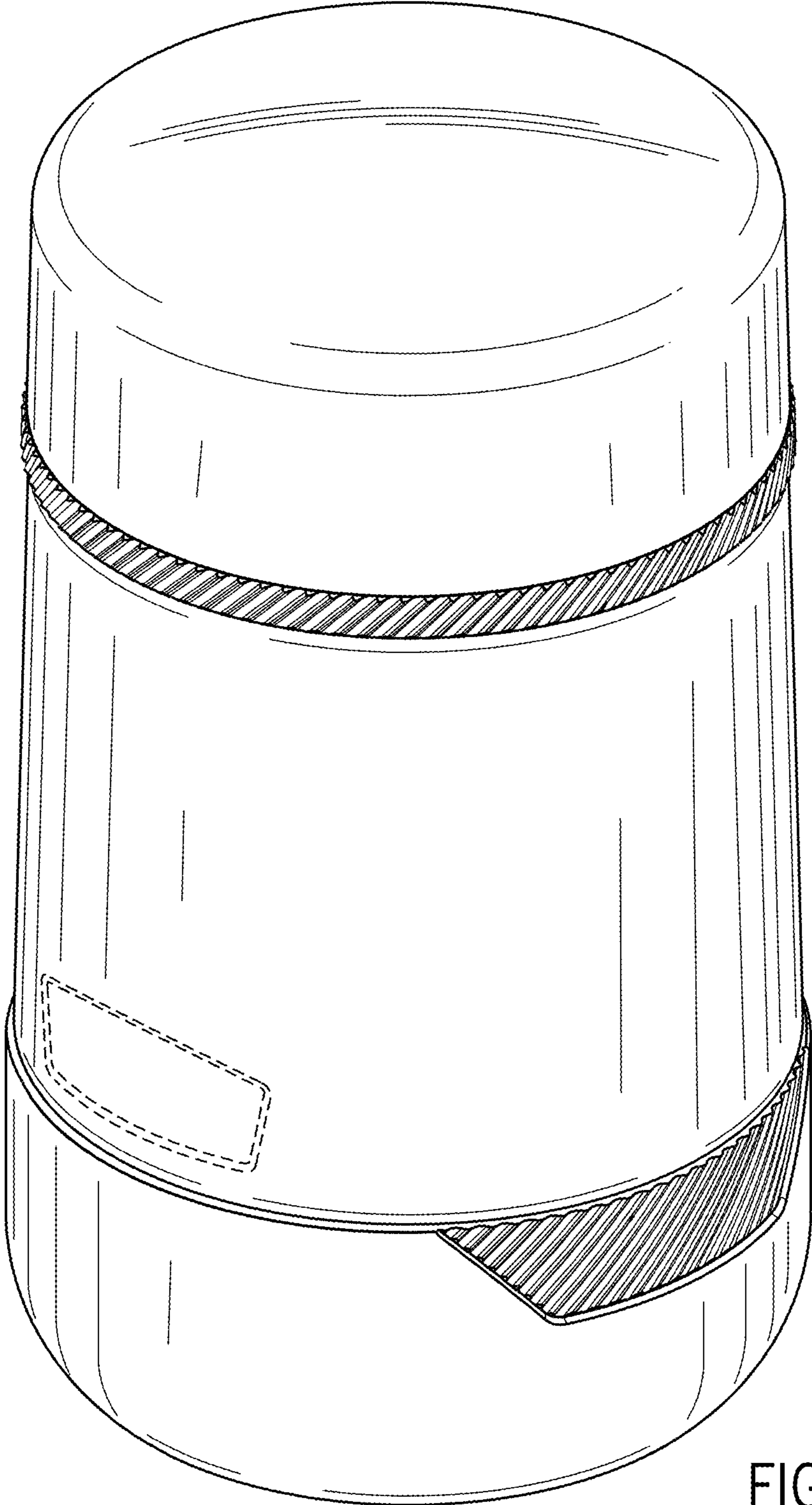

FIG. 1

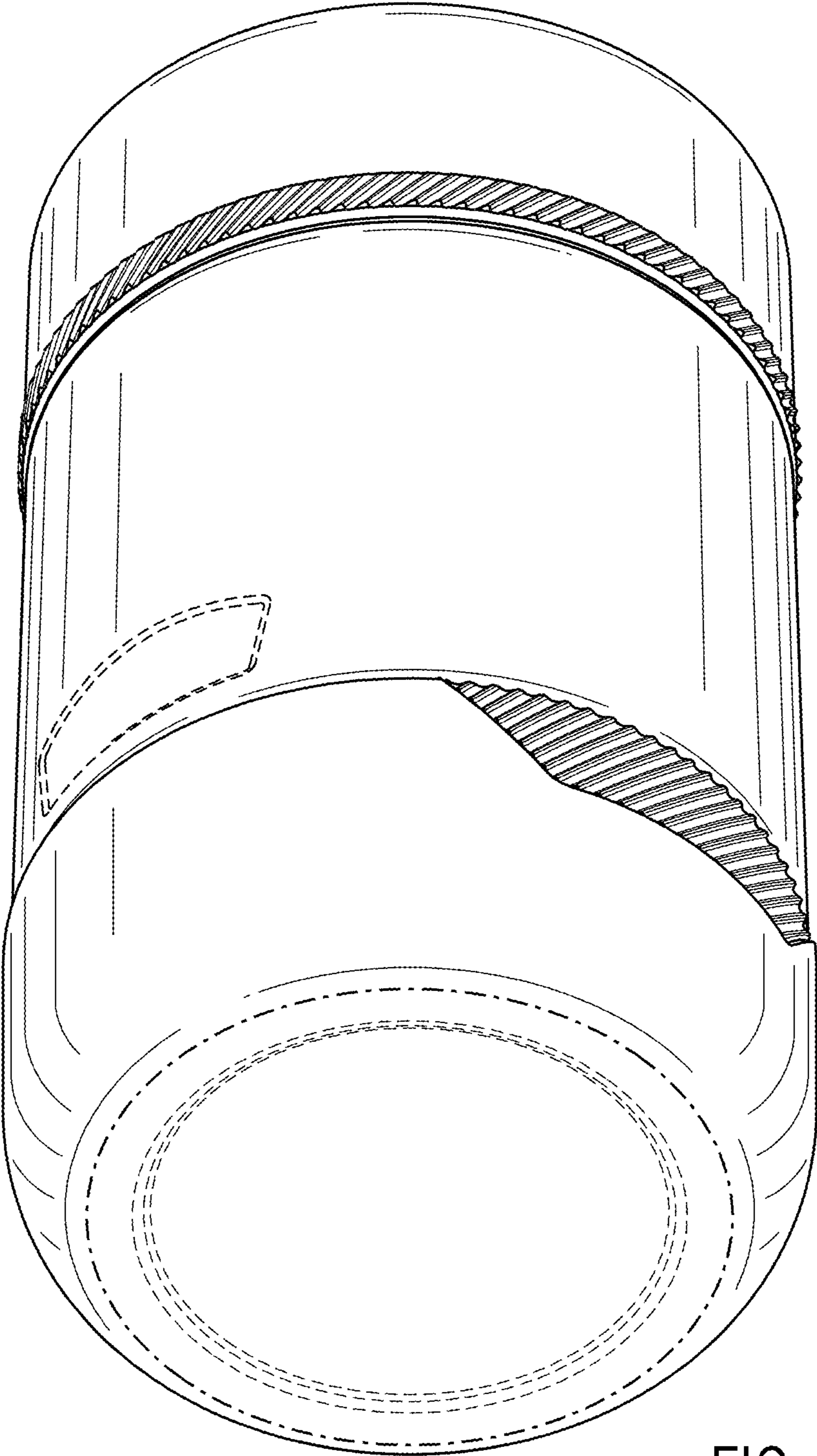

FIG. 2

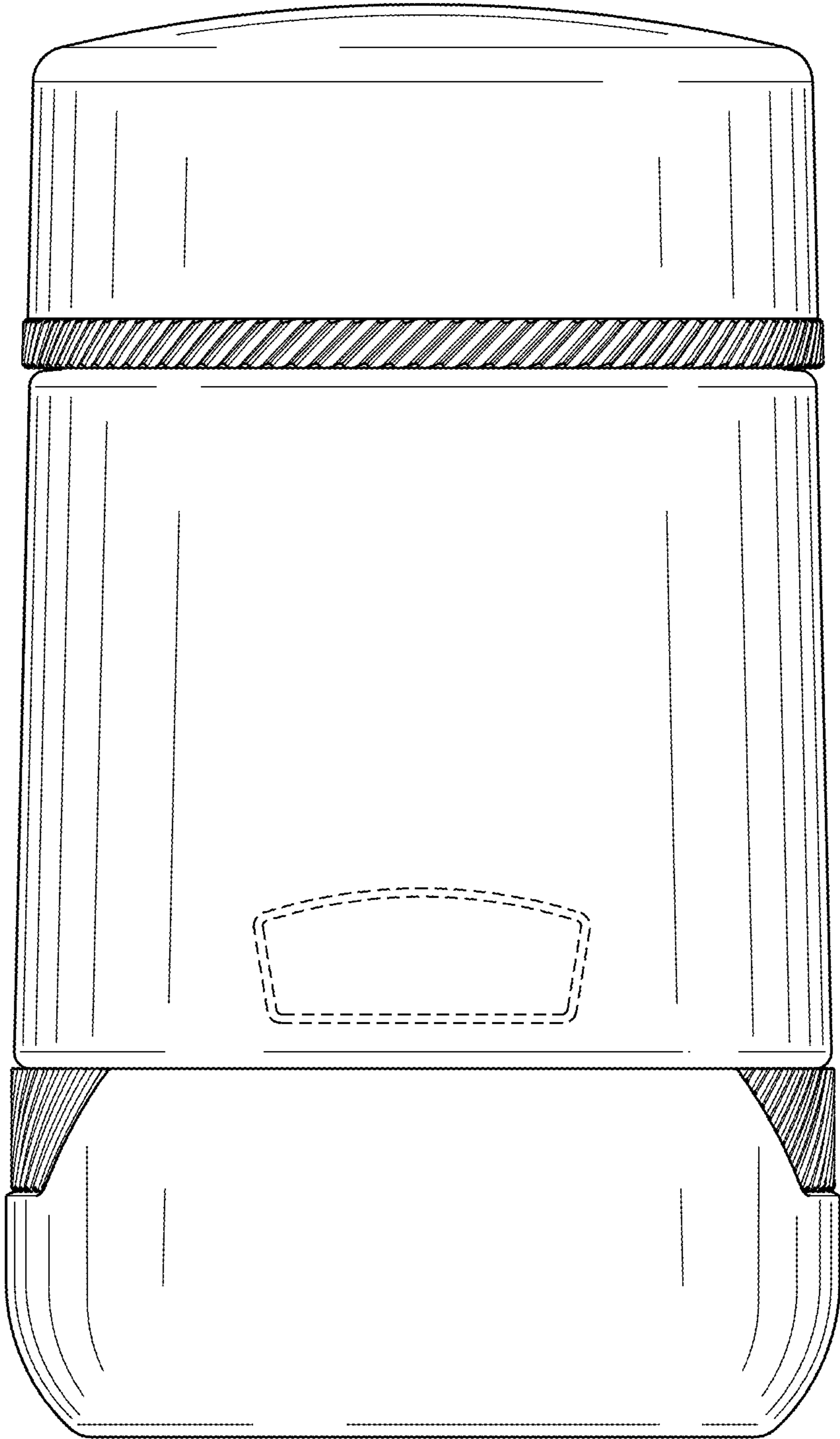

FIG. 3

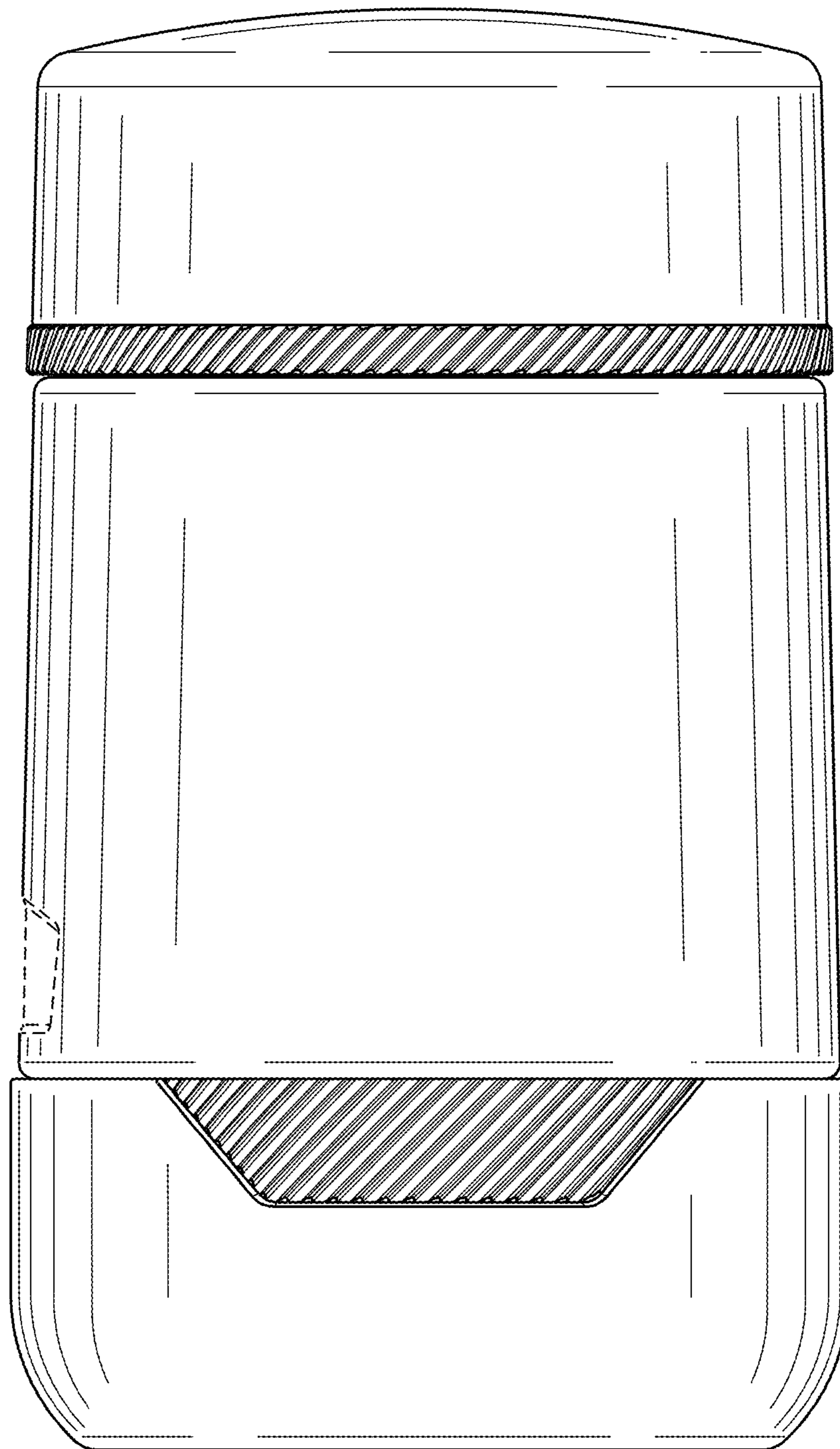

FIG. 4

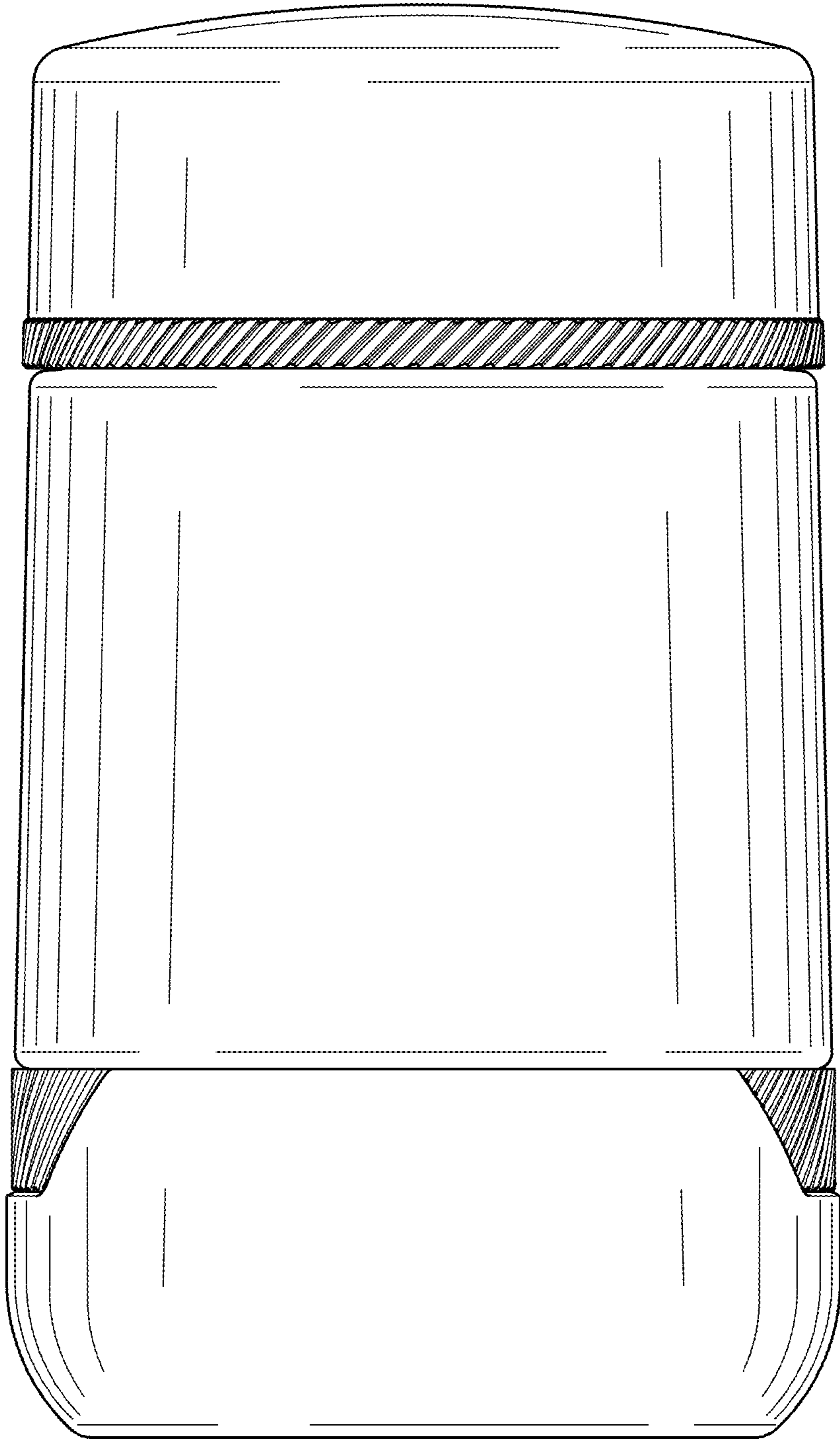

FIG. 5

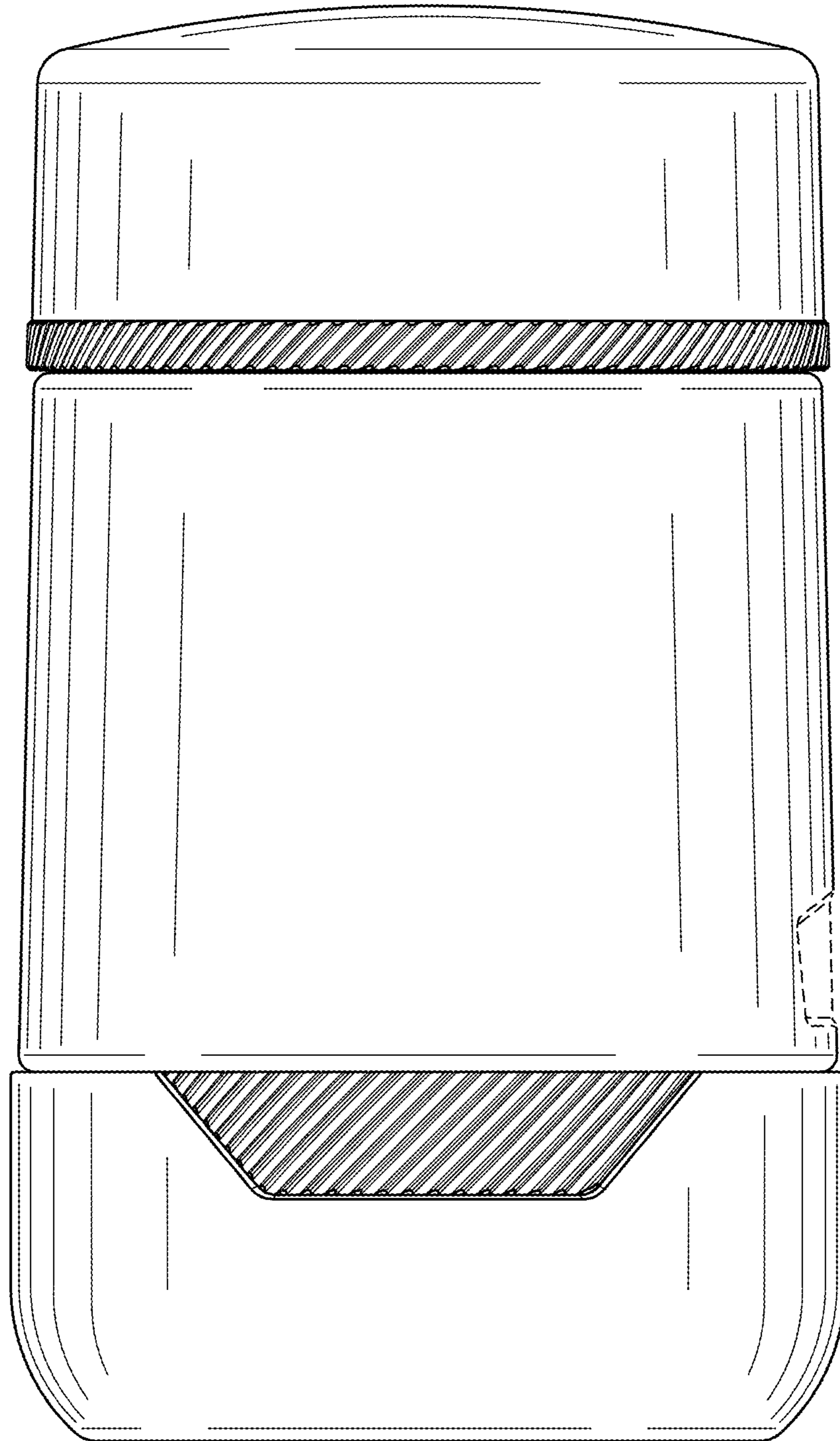

FIG. 6

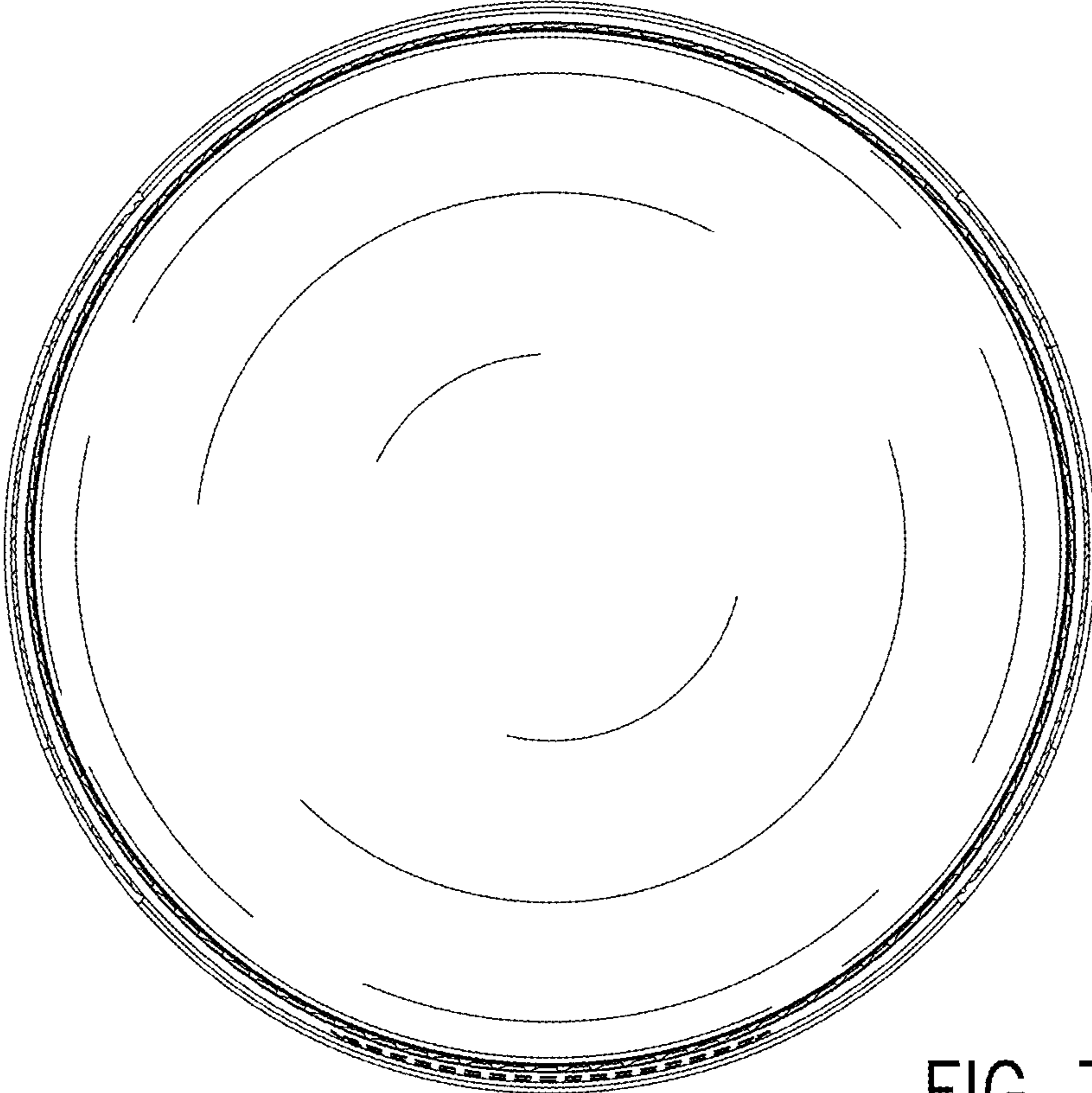

FIG. 7

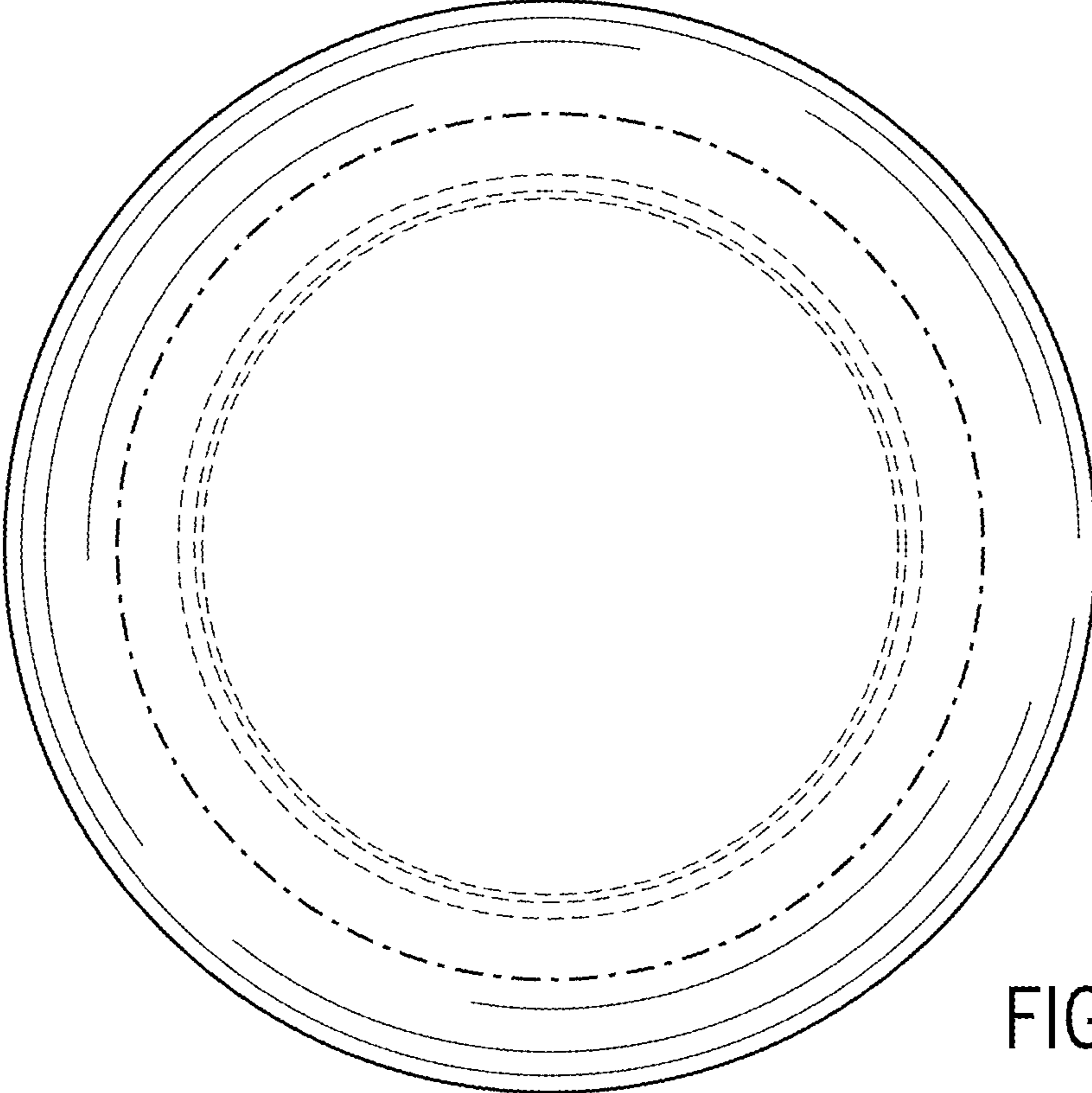

FIG. 8

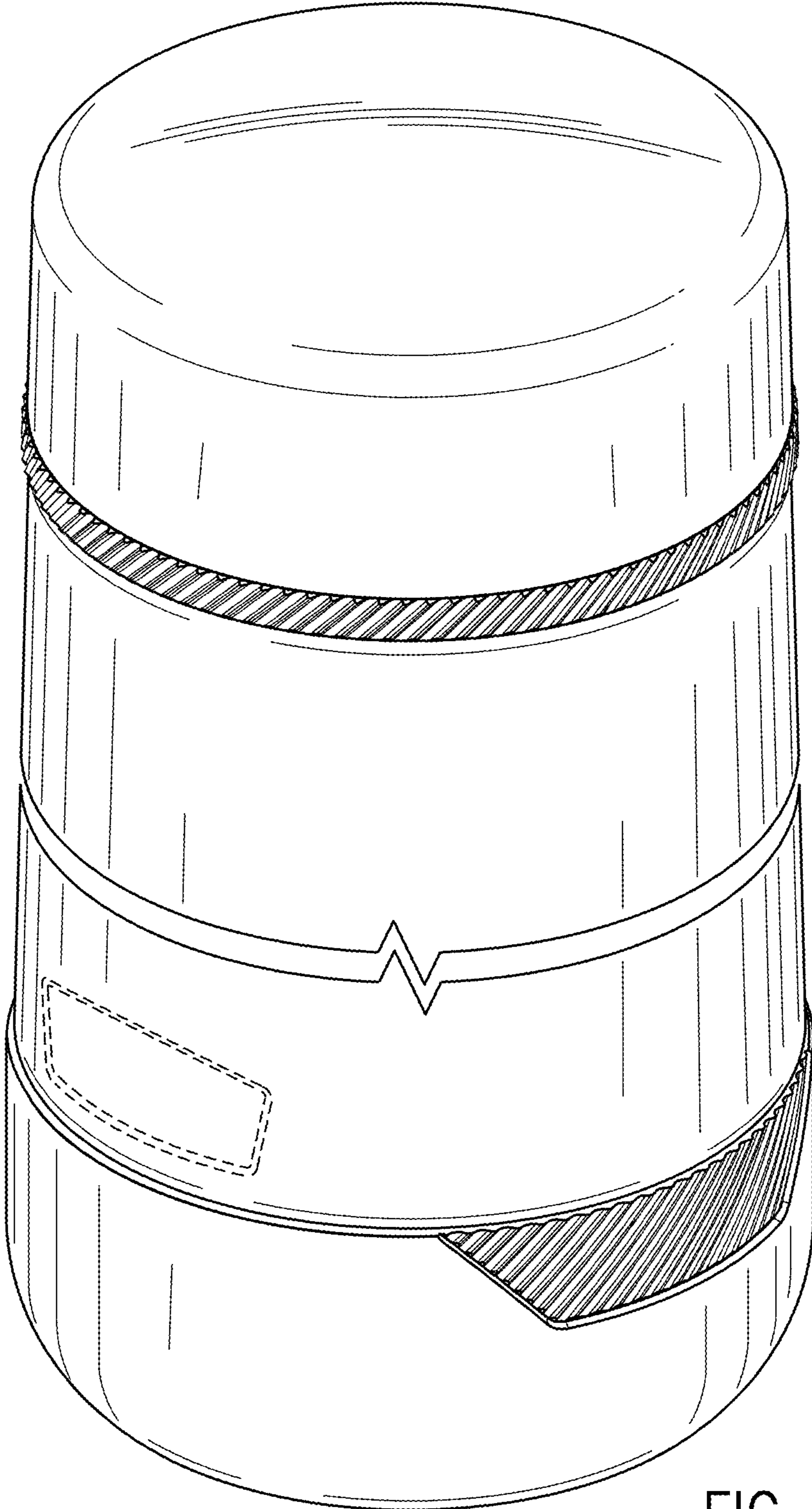

FIG. 9

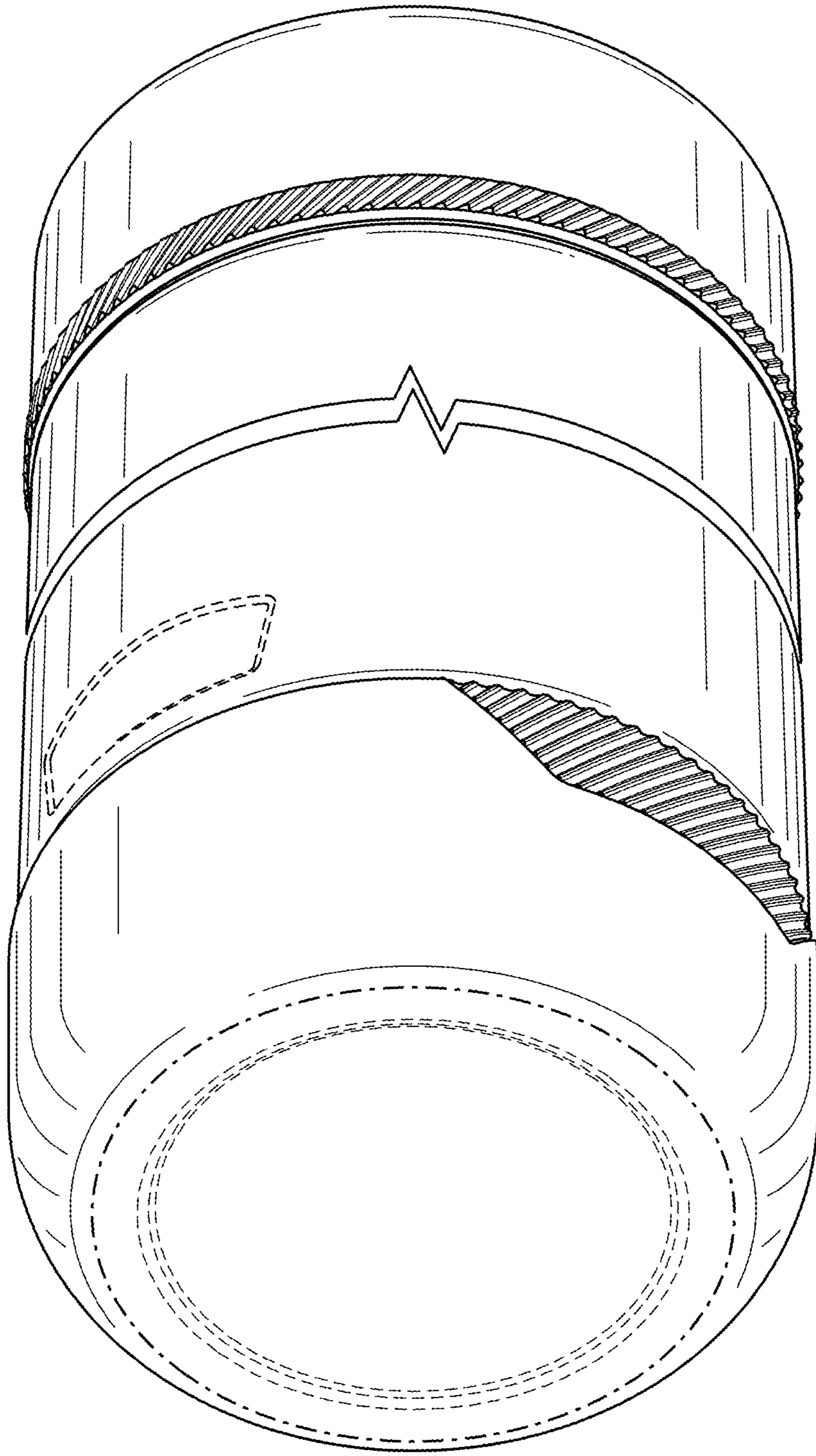

FIG. 10

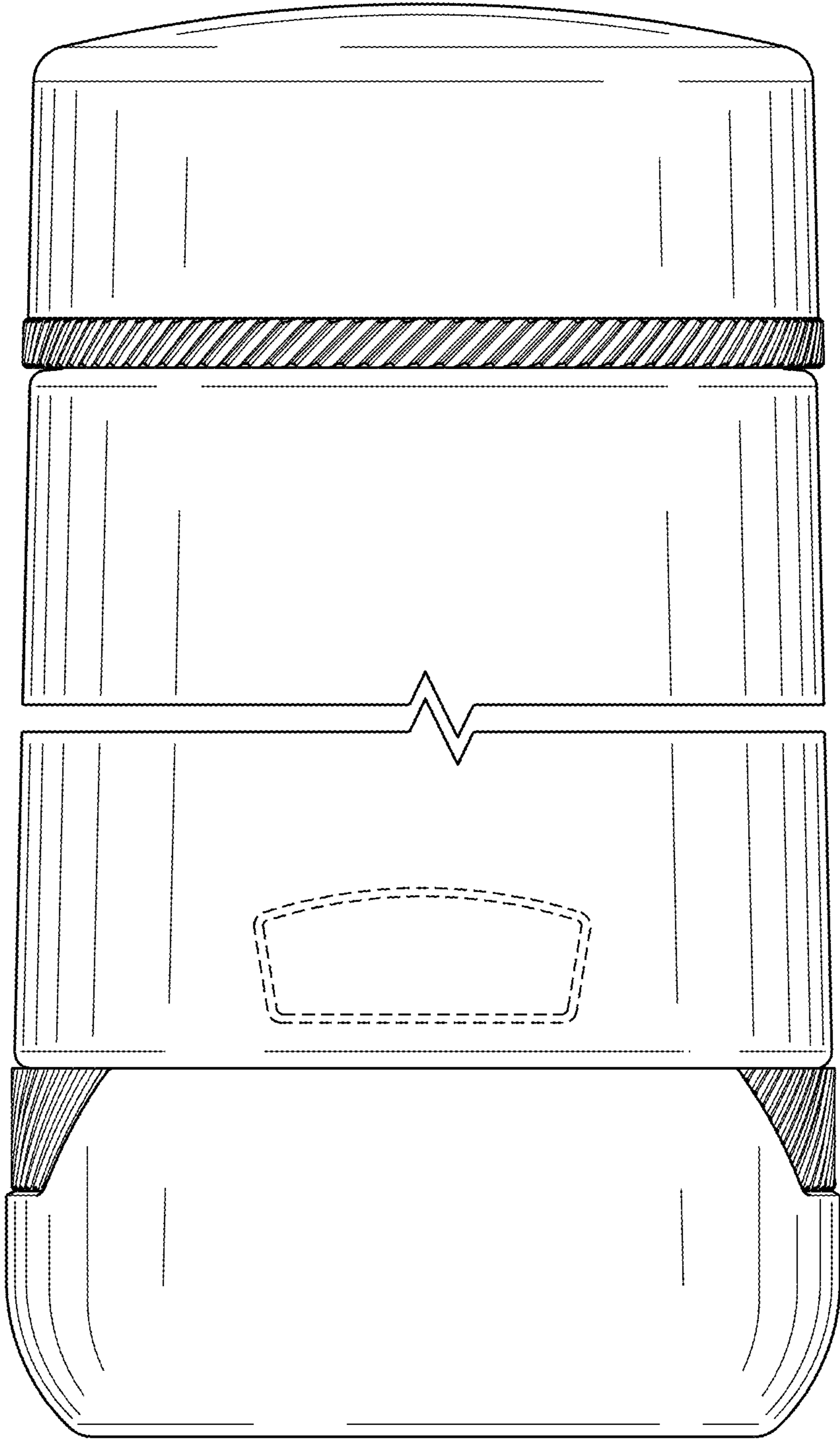

FIG. 11

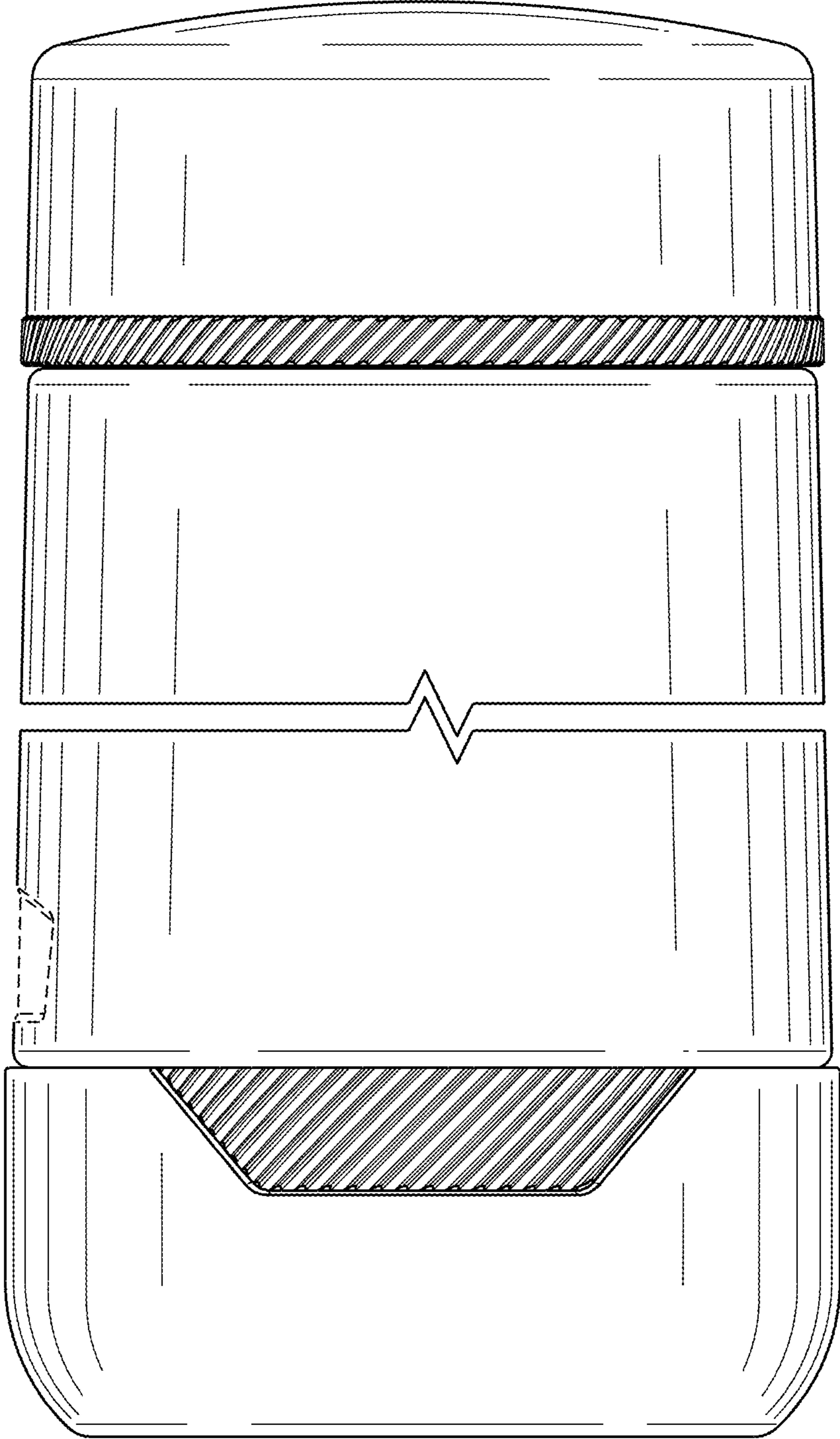

FIG. 12

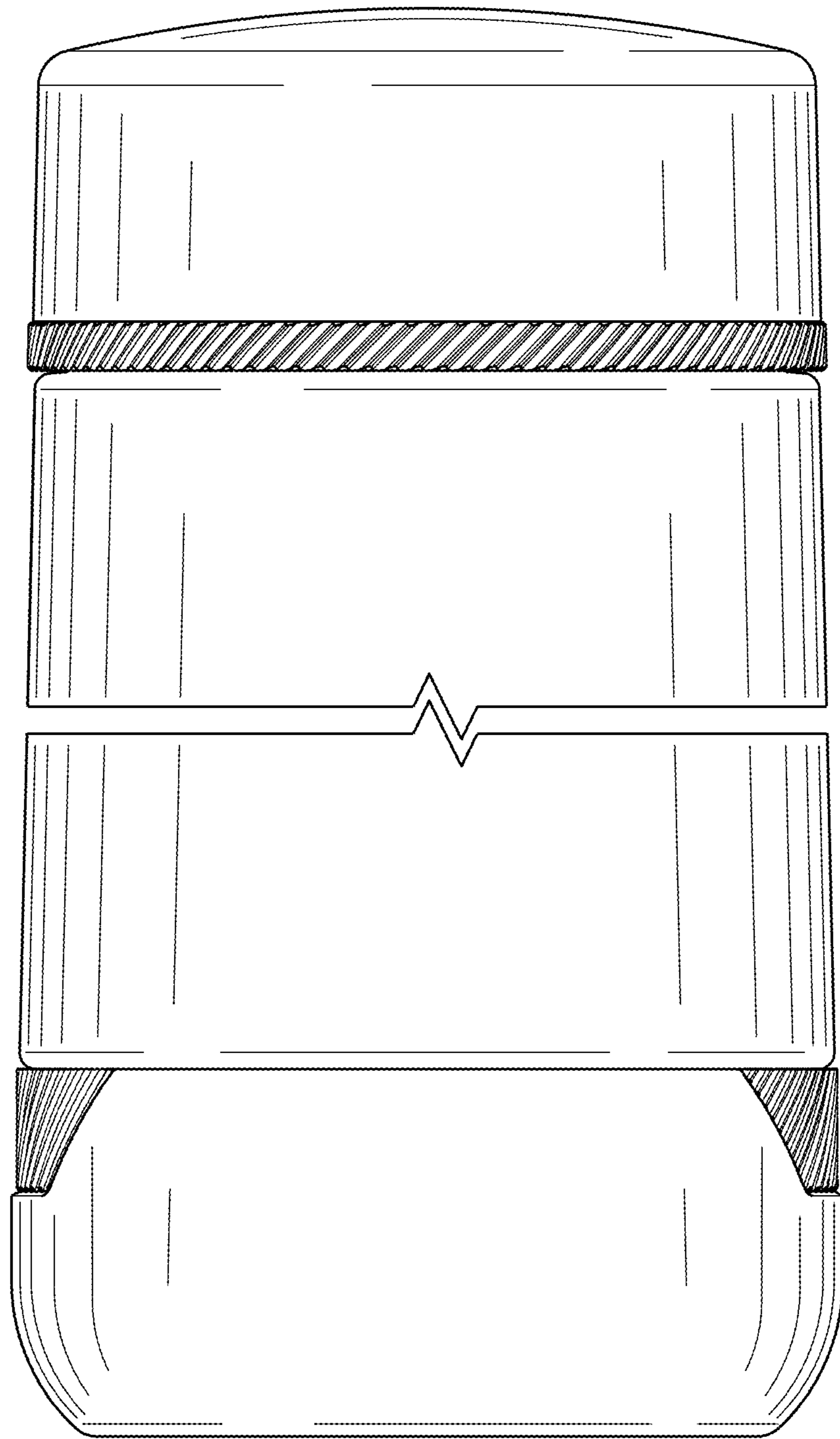

FIG. 13

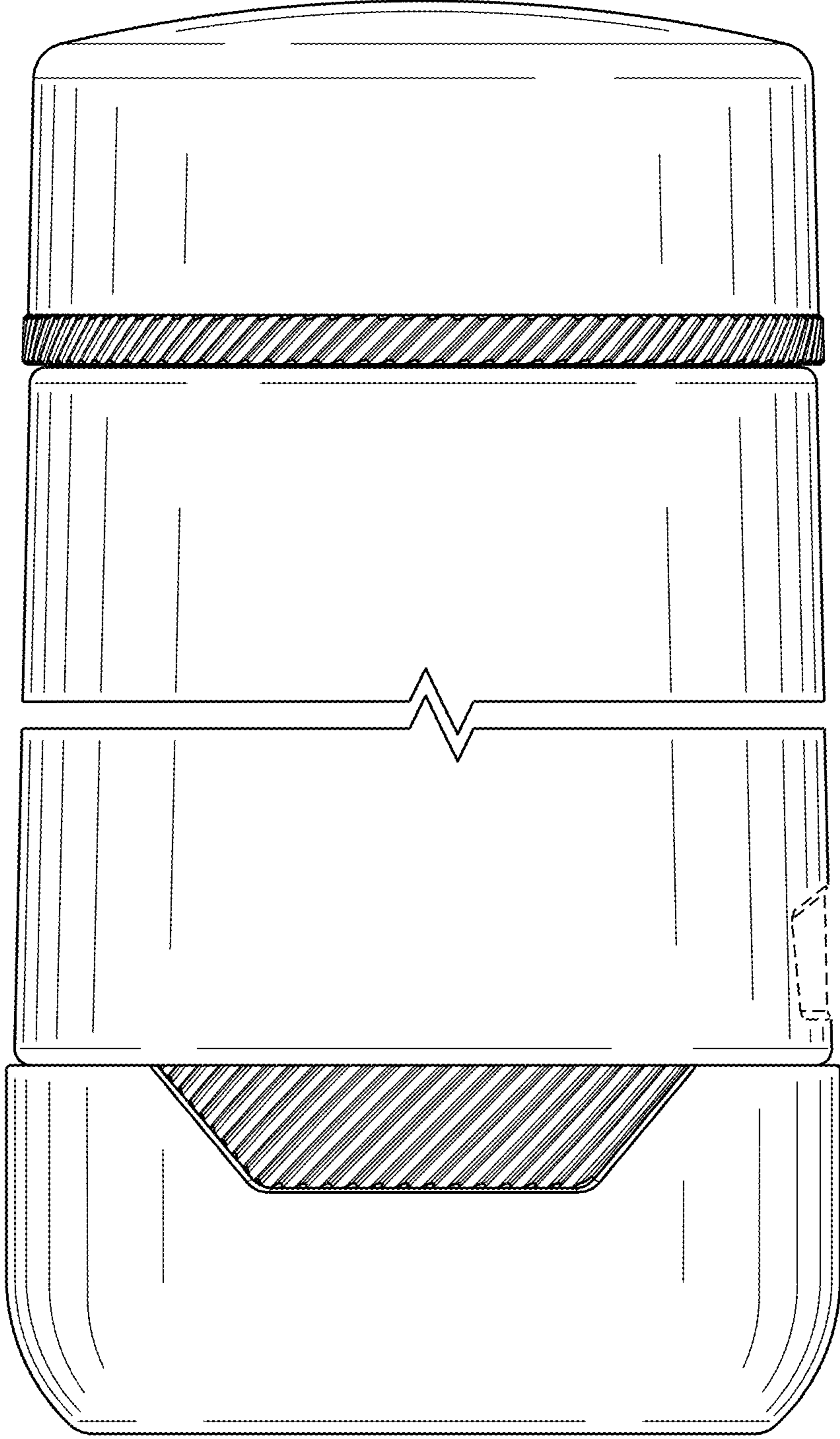

FIG. 14

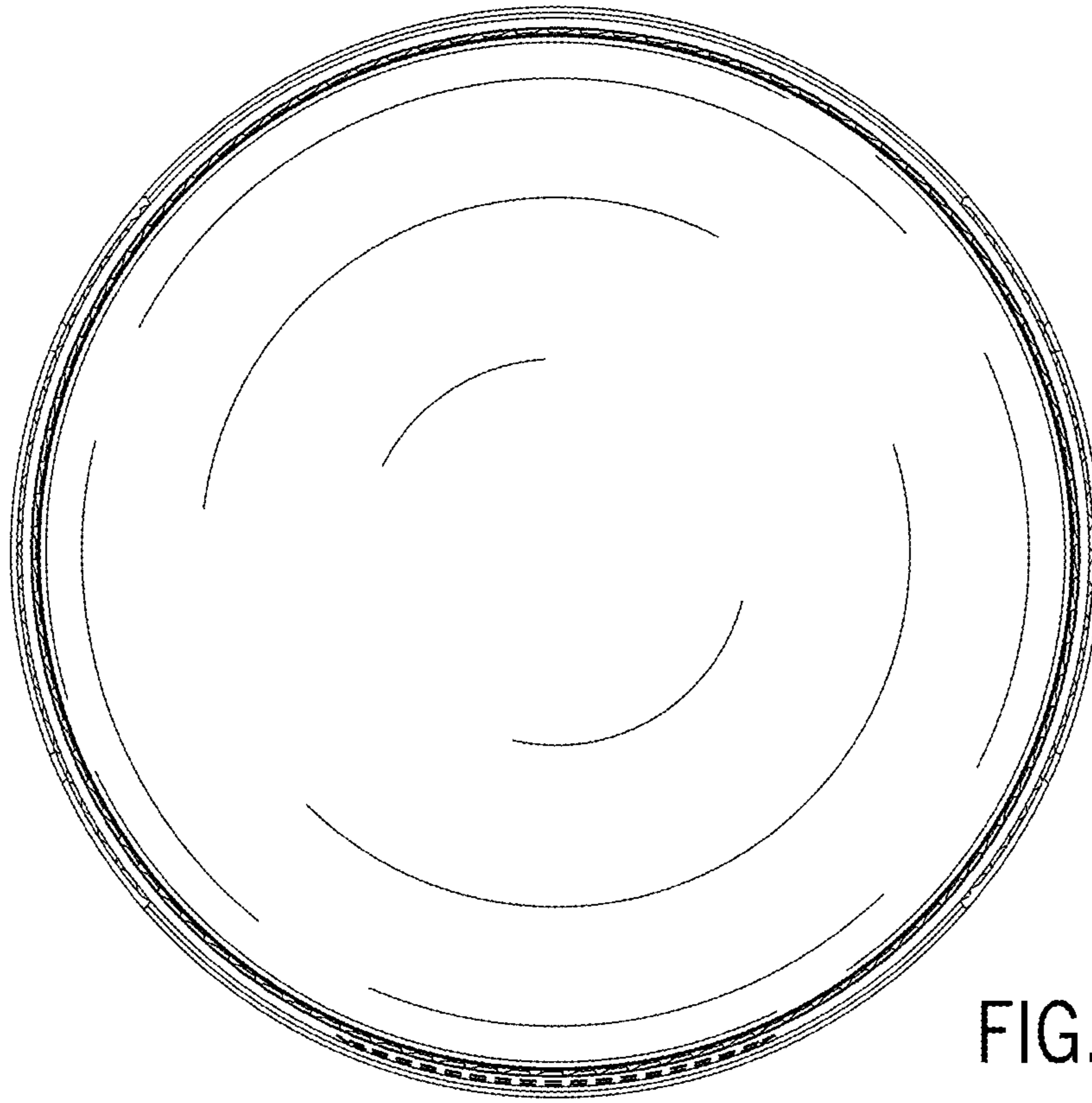

FIG. 15

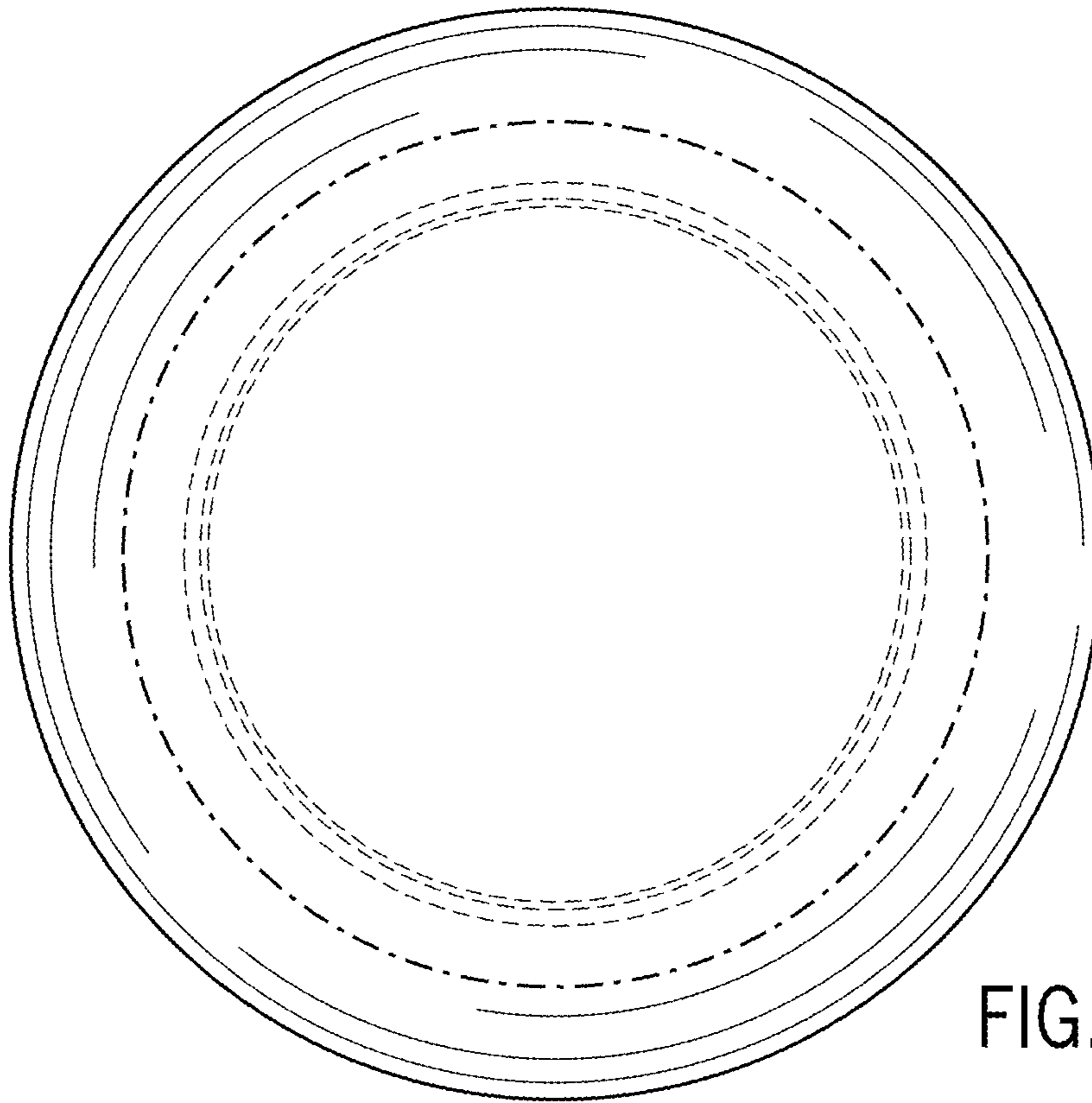

FIG. 16