



US00D899826S

(12) **United States Design Patent**  
**Cheng**

(10) **Patent No.:** **US D899,826 S**

(45) **Date of Patent:** **\*\* Oct. 27, 2020**

(54) **SHELF**

(71) Applicant: **GUANGDONG WIREKING  
HOUSEWARES & HARDWARE  
CO., LTD**, Foshan (CN)

(72) Inventor: **Chunxuan Cheng**, Foshan (CN)

(73) Assignee: **GUANGDONG WIREKING  
HOUSEWARES & HARDWARE  
CO., LTD**, Foshan (CN)

(\*\*) Term: **15 Years**

(21) Appl. No.: **29/738,052**

(22) Filed: **Jun. 15, 2020**

(51) **LOC (12) Cl.** ..... **06-06**

(52) **U.S. Cl.**  
USPC ..... **D6/675.1; D34/21**

(58) **Field of Classification Search**  
USPC ..... D3/304-315; D6/653, 653.1, 672, 675,  
D6/675.1, 675.2, 675.5; D34/12, 21, 23  
CPC ..... B62B 3/00; B62B 3/002; B62B 3/005;  
B62B 2501/067  
See application file for complete search history.

(56) **References Cited**

**U.S. PATENT DOCUMENTS**

|                |         |              |       |                       |
|----------------|---------|--------------|-------|-----------------------|
| D301,652 S *   | 6/1989  | Roberts      | ..... | D34/21                |
| D341,459 S *   | 11/1993 | Yang         | ..... | D34/17                |
| D436,239 S *   | 1/2001  | Walsh        | ..... | D34/17                |
| 6,173,847 B1 * | 1/2001  | Zellner, III | ..... | A47B 55/02<br>211/186 |
| D517,769 S *   | 3/2006  | Post         | ..... | D34/21                |
| D534,017 S *   | 12/2006 | Cuzzocrea    | ..... | D6/675.3              |
| D636,550 S *   | 4/2011  | Molayem      | ..... | D34/21                |
| D703,412 S *   | 4/2014  | Snider       | ..... | D34/21                |
| D734,914 S *   | 7/2015  | Tsai         | ..... | D34/21                |
| D742,613 S *   | 11/2015 | Hu           | ..... | D34/21                |

|              |         |           |       |          |
|--------------|---------|-----------|-------|----------|
| D747,837 S * | 1/2016  | Chang     | ..... | D34/21   |
| D748,359 S * | 1/2016  | Lustig    | ..... | D34/21   |
| D752,906 S * | 4/2016  | Gunderson | ..... | D6/675.1 |
| D756,584 S * | 5/2016  | Dunford   | ..... | D34/12   |
| D757,387 S * | 5/2016  | Cao       | ..... | D34/21   |
| D758,688 S * | 6/2016  | Nai       | ..... | D34/12   |
| D761,043 S * | 7/2016  | Snider    | ..... | D6/675.2 |
| D784,738 S   | 4/2017  | Wang      |       |          |
| D785,979 S * | 5/2017  | Snider    | ..... | D6/675.1 |
| D786,524 S * | 5/2017  | Sherman   | ..... | D34/21   |
| D831,292 S * | 10/2018 | Thuma     | ..... | D34/12   |
| D831,390 S * | 10/2018 | Li        | ..... | D6/675.1 |
| D832,549 S * | 10/2018 | Cao       | ..... | D34/21   |
| D846,824 S * | 4/2019  | Cao       | ..... | D34/21   |
| D846,825 S * | 4/2019  | Cao       | ..... | D34/21   |
| D850,753 S * | 6/2019  | Cao       | ..... | D34/21   |
| D852,448 S * | 6/2019  | Hu        | ..... | D34/12   |
| D852,449 S * | 6/2019  | Hu        | ..... | D34/21   |
| D858,928 S * | 9/2019  | Cao       | ..... | D34/21   |
| D862,949 S   | 10/2019 | Ghiorghie |       |          |
| D866,904 S * | 11/2019 | Sainato   | ..... | D34/21   |

(Continued)

Primary Examiner — Kelley A Donnelly

(57) **CLAIM**

The ornamental design for a shelf, as shown and described.

**DESCRIPTION**

FIG. 1 is a perspective view of a shelf showing my new design;  
FIG. 2 is another perspective view thereof;  
FIG. 3 is a front elevational view thereof;  
FIG. 4 is a rear elevational view thereof;  
FIG. 5 is a left side elevational view thereof;  
FIG. 6 is a right side elevational view thereof;  
FIG. 7 is a top plan view thereof;  
FIG. 8 is a bottom plan view thereof; and,  
FIG. 9 is an enlarged view of portion 9 shown in FIG. 1.  
The broken lines in the drawings depict portions of the shelf that form no part of the claimed design.

**1 Claim, 9 Drawing Sheets**

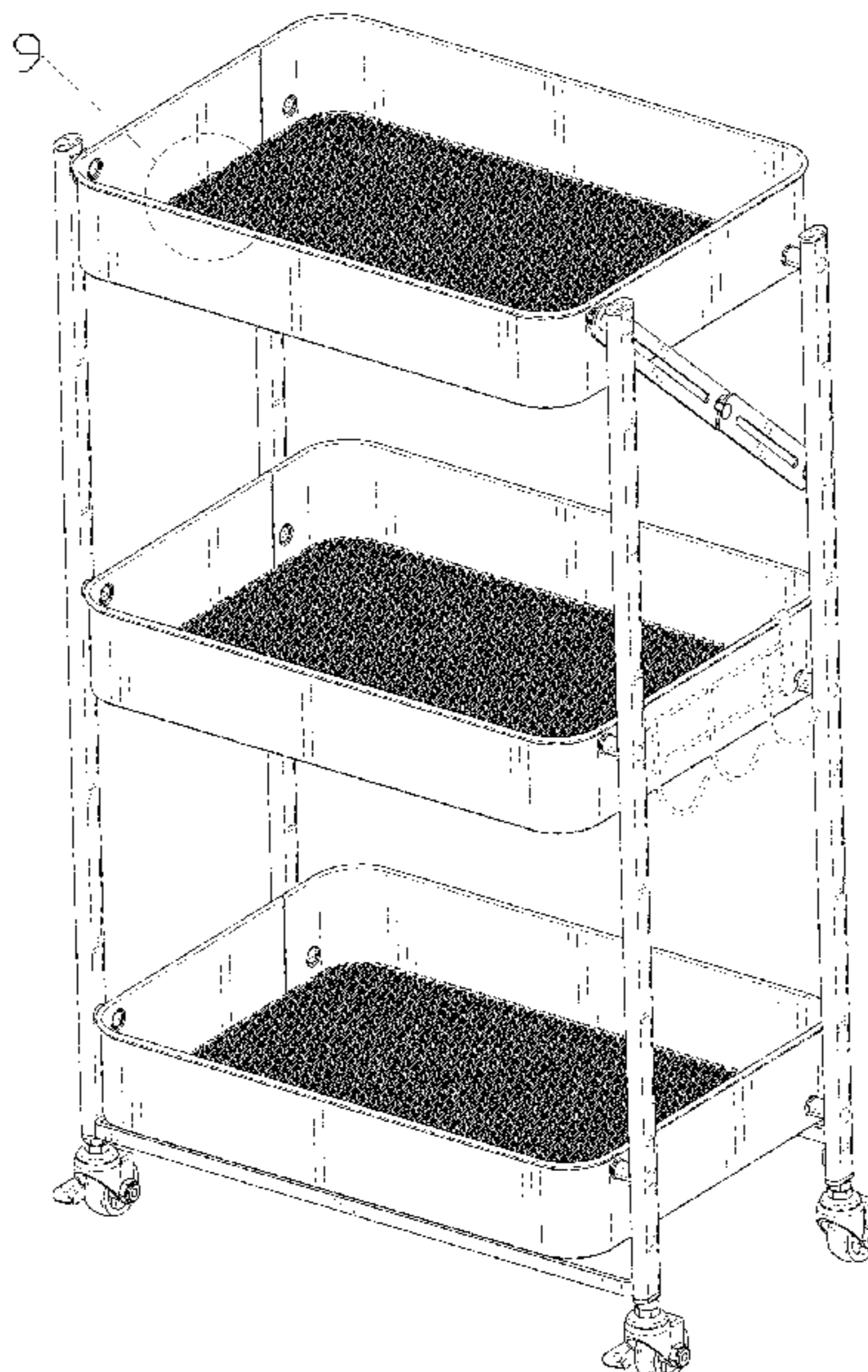

(56)

**References Cited**

U.S. PATENT DOCUMENTS

D874,778 S \* 2/2020 Stauff ..... D34/21  
D887,101 S \* 6/2020 Beasley ..... D34/21  
2006/0032829 A1\* 2/2006 Hutzler ..... A47B 55/02  
211/187  
2010/0288717 A1\* 11/2010 Morandi ..... A47B 43/00  
211/187  
2018/0257913 A1\* 9/2018 Thomsen ..... B08B 1/02  
2020/0216104 A1\* 7/2020 Leblanc ..... A47B 9/04

\* cited by examiner

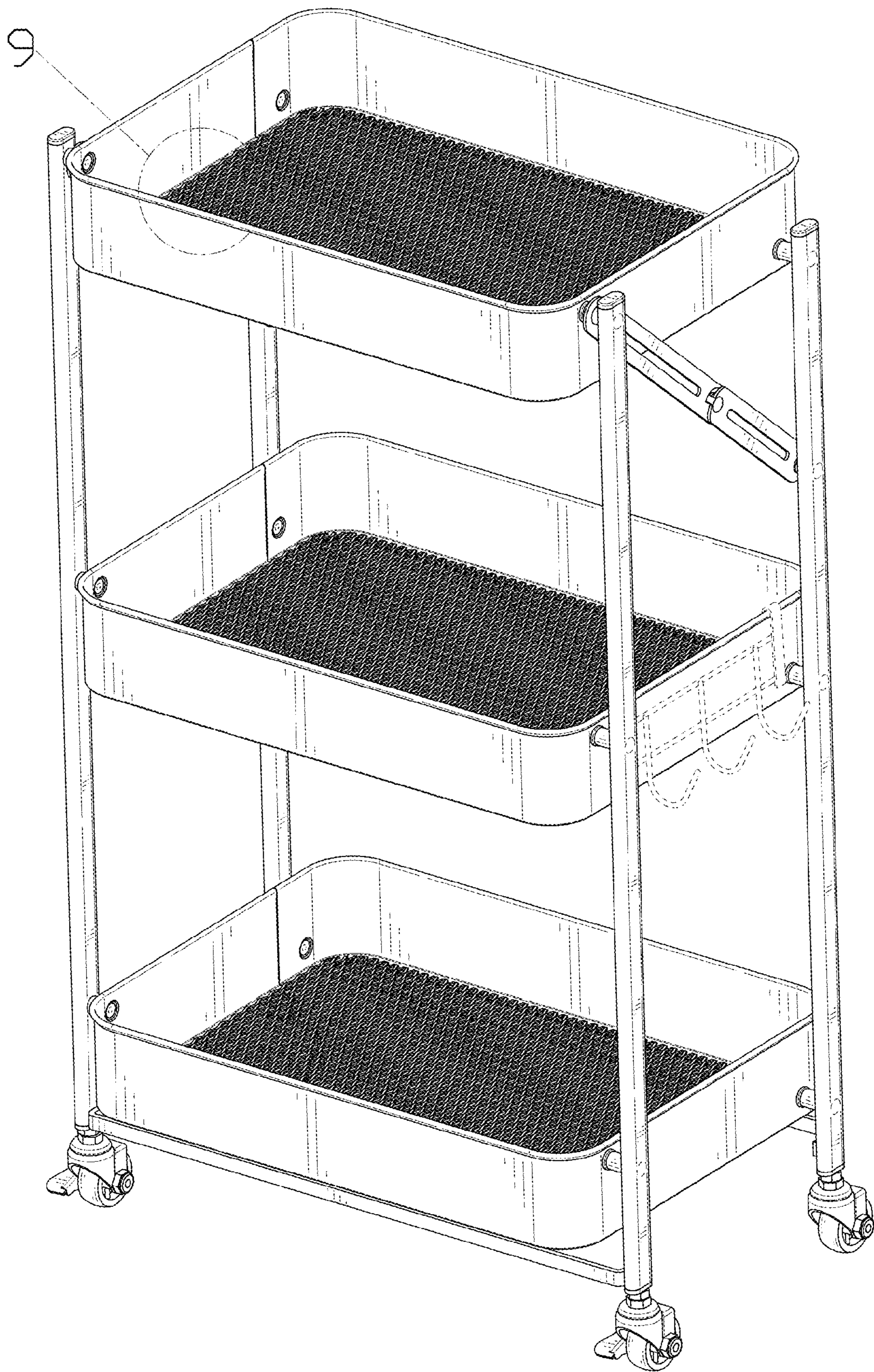

FIG. 1

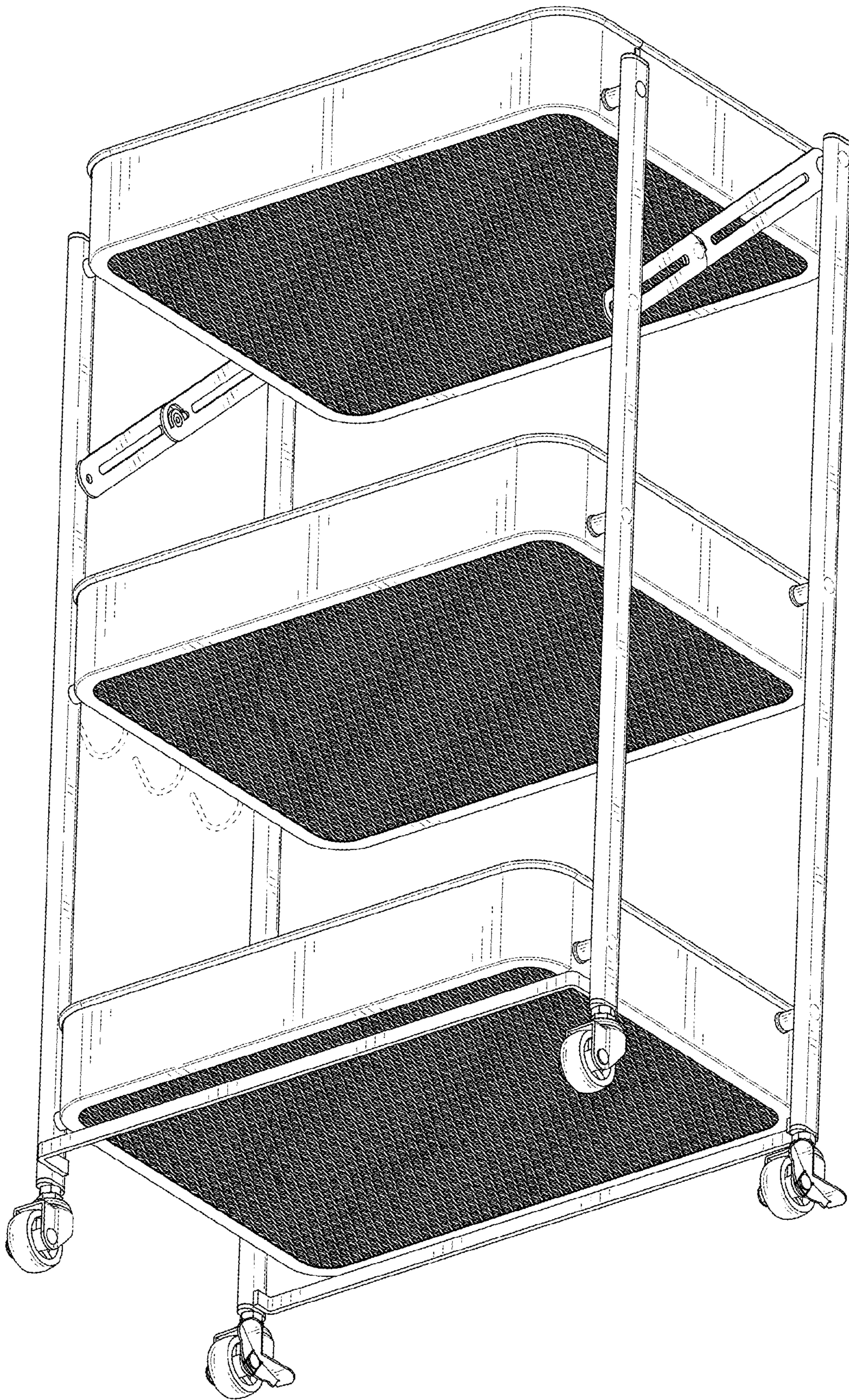

FIG. 2

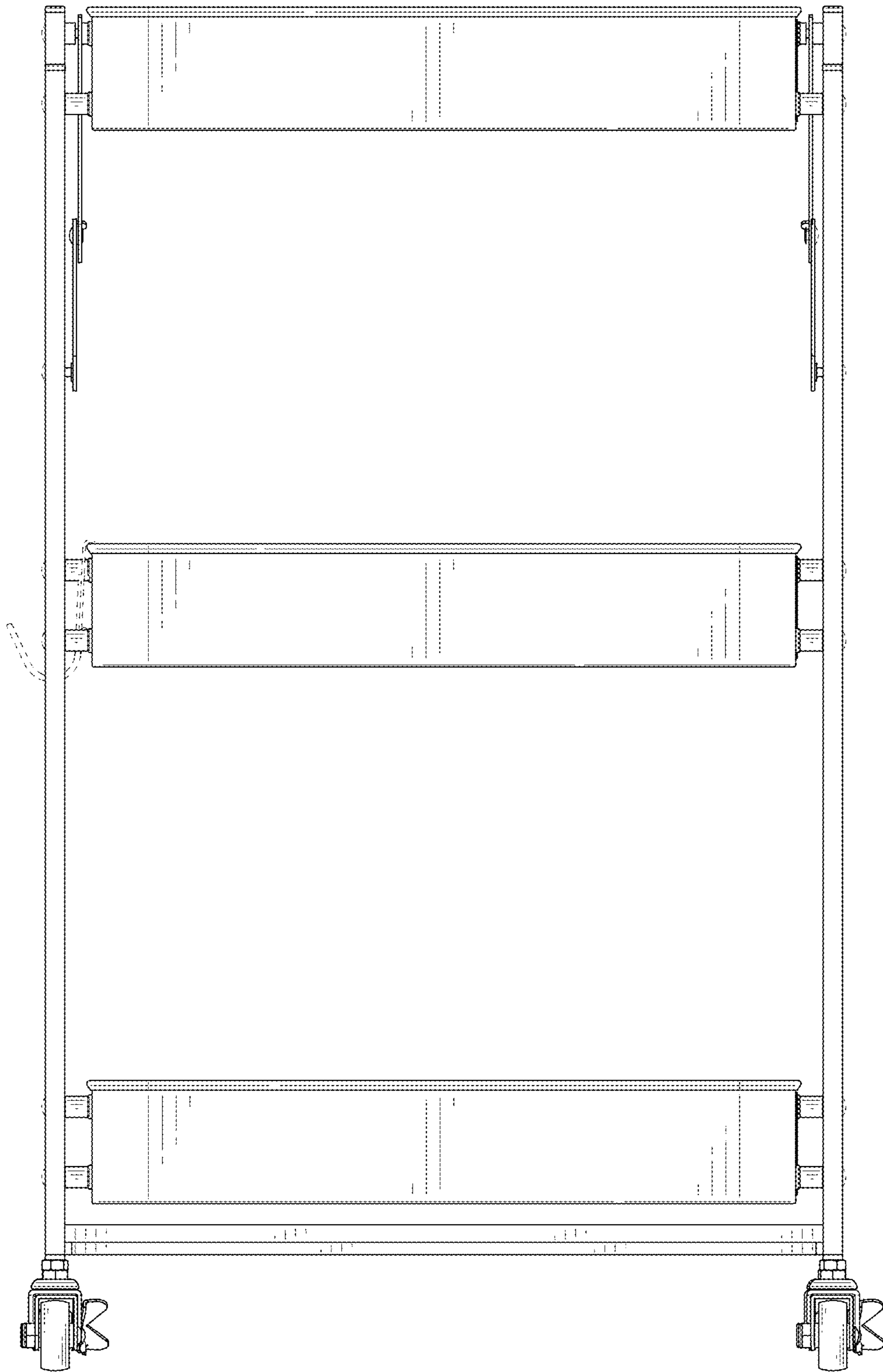

FIG. 3

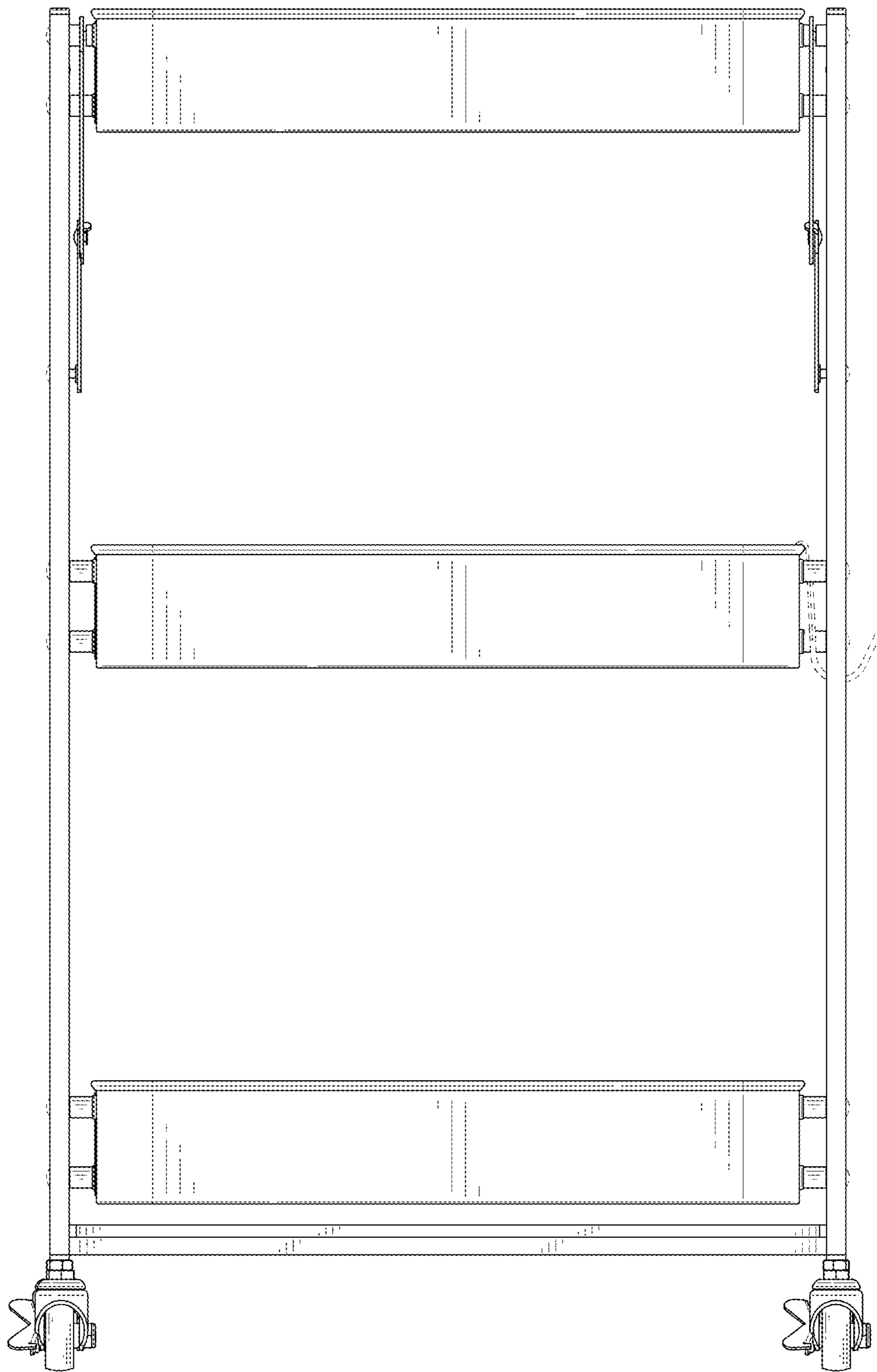

FIG. 4

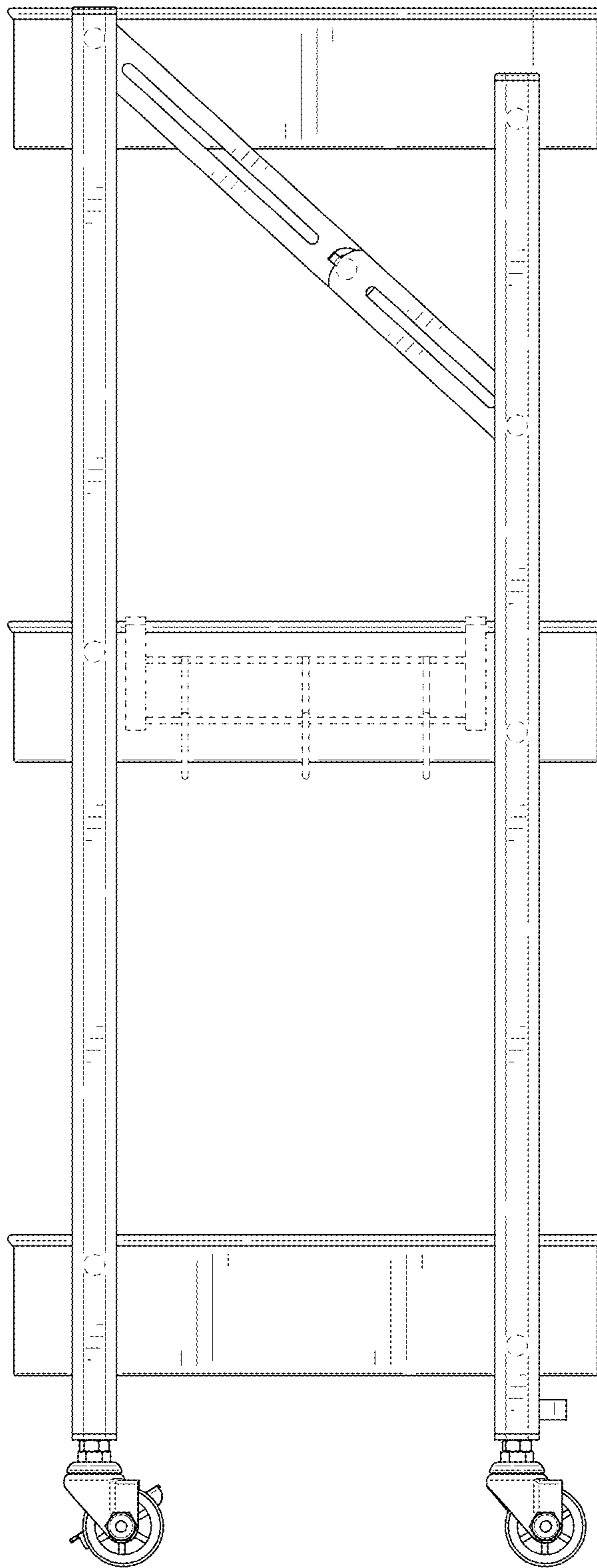

FIG. 5

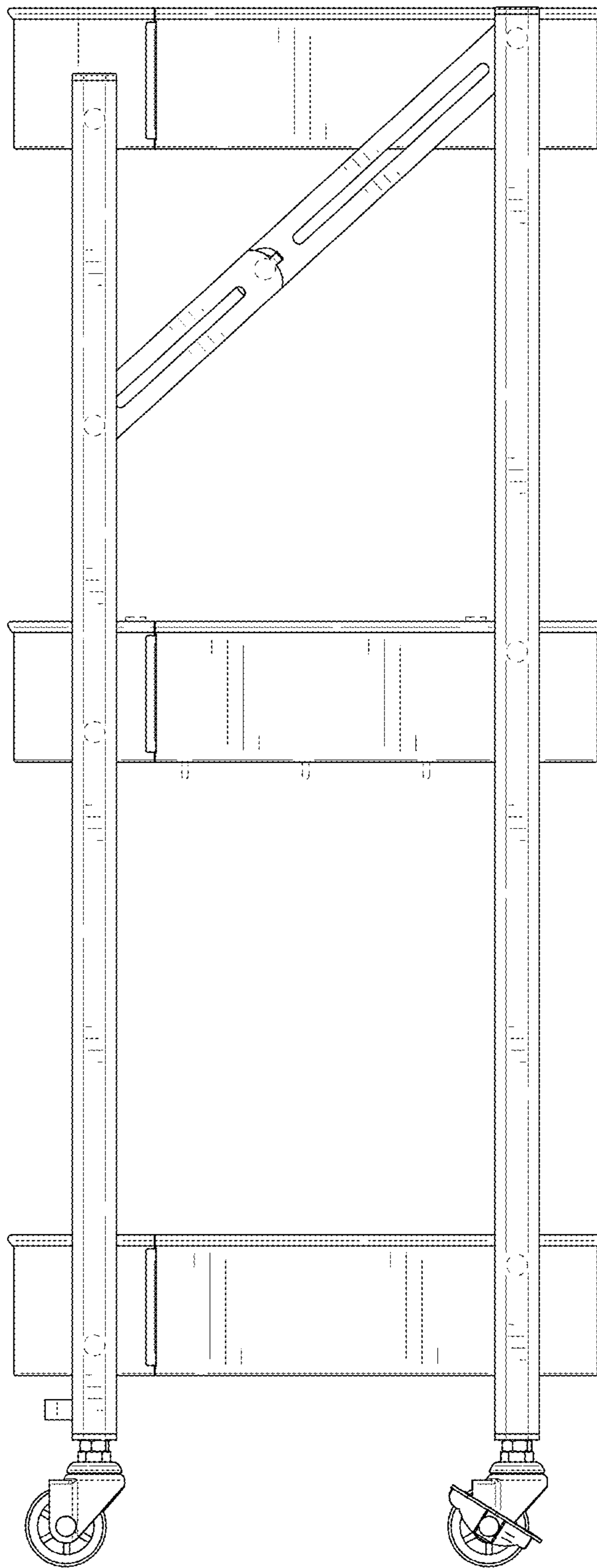

FIG. 6



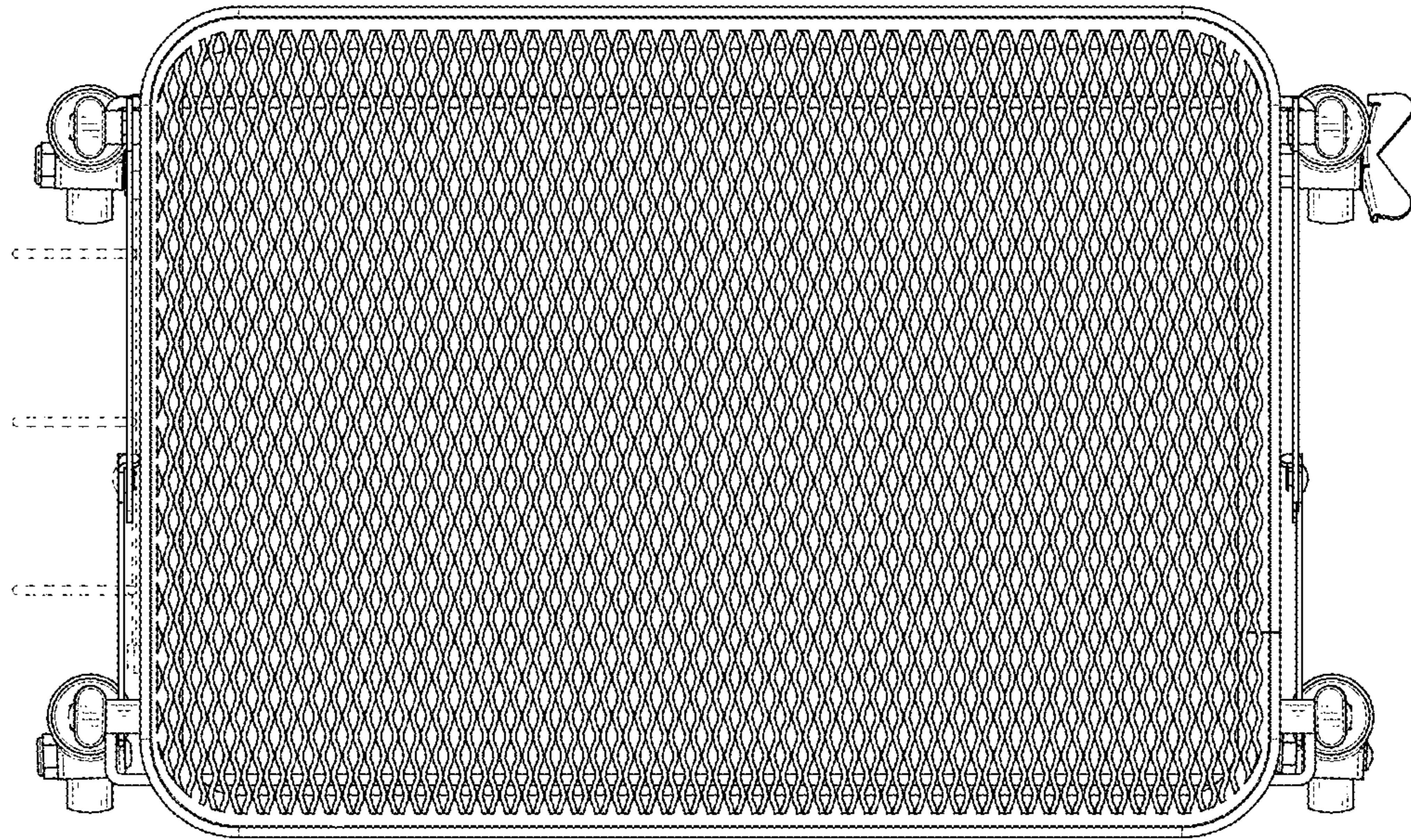

FIG. 7

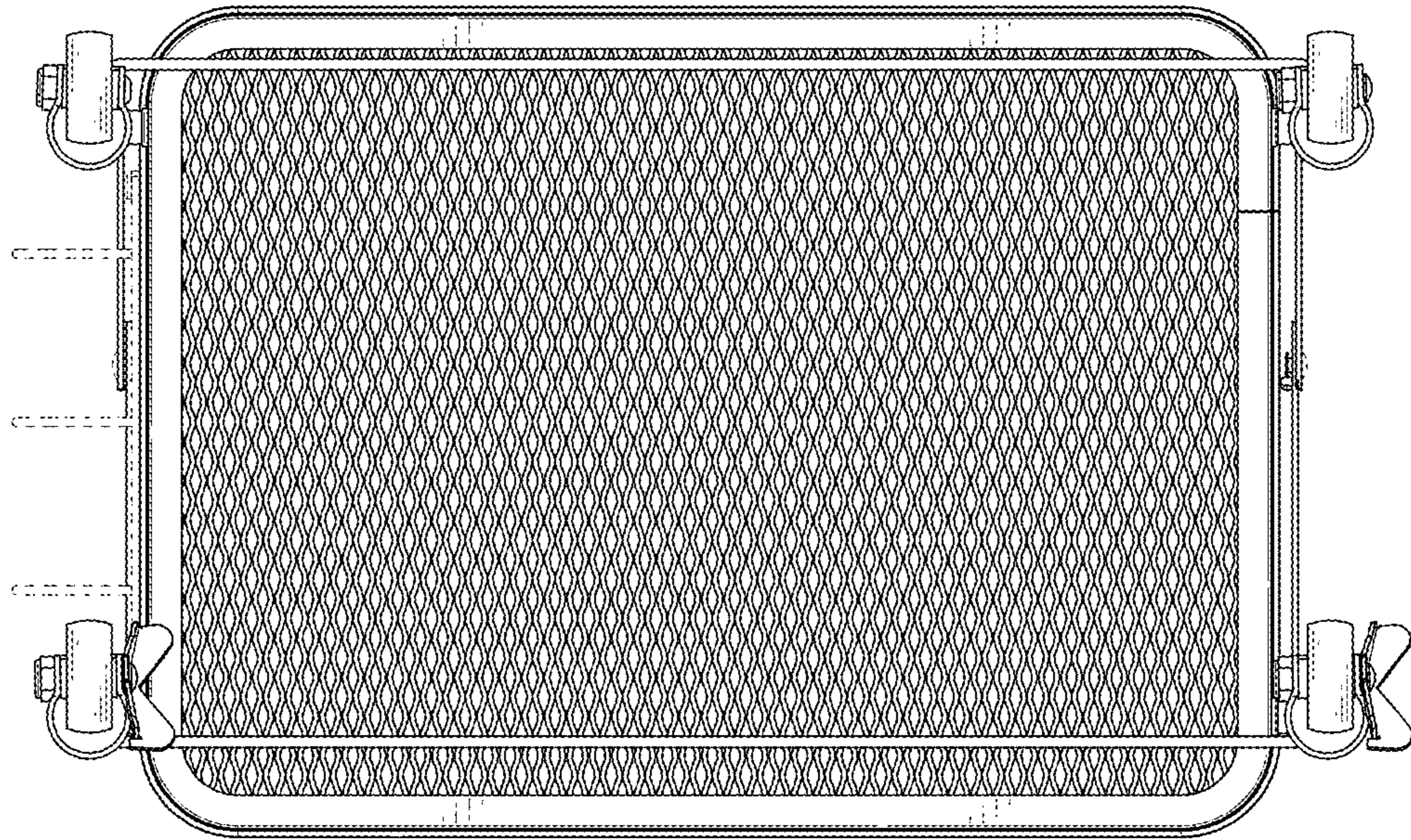

FIG. 8

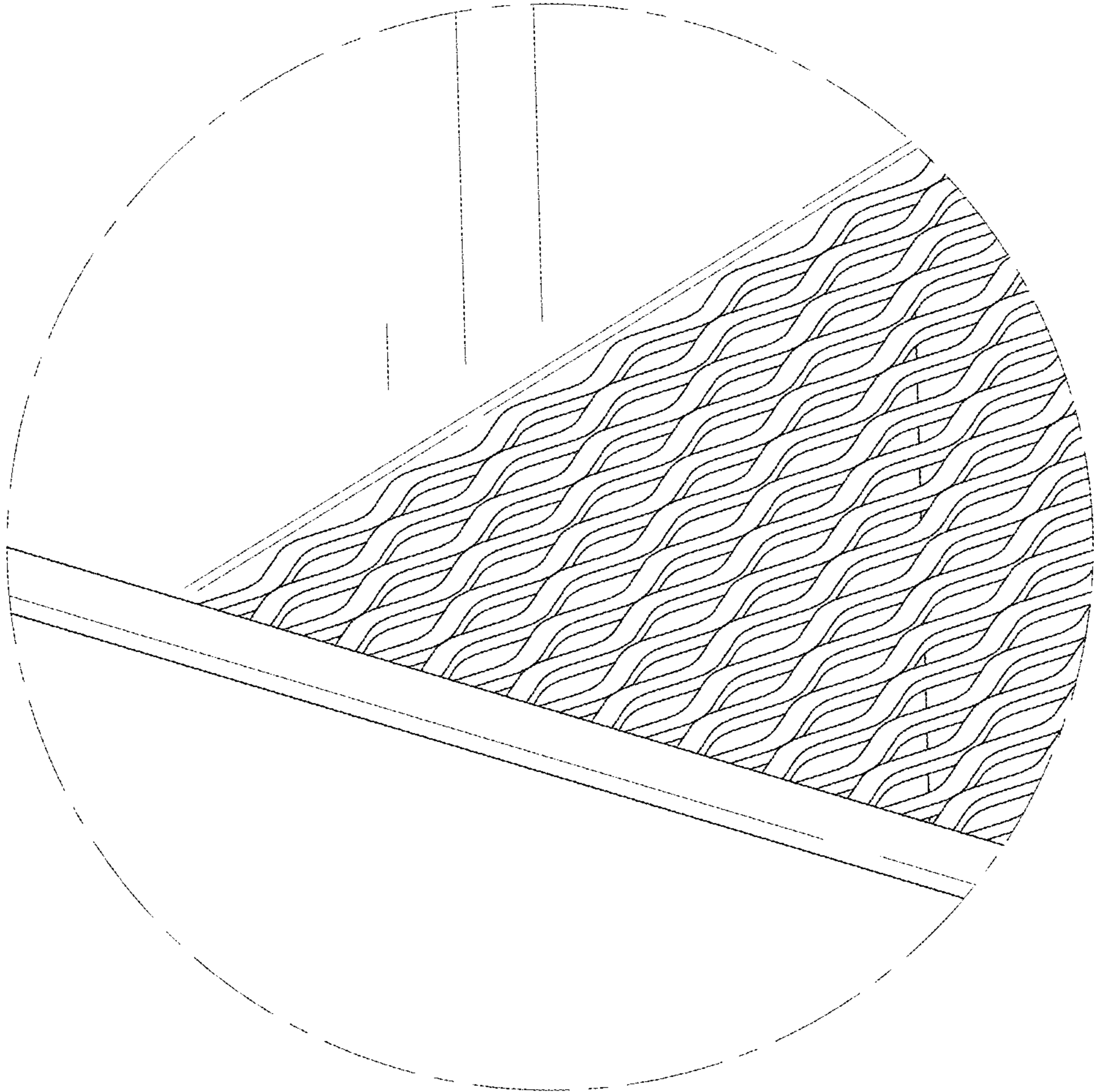

FIG. 9