



US00D899822S

(12) **United States Design Patent** (10) **Patent No.:** **US D899,822 S**
Wang (45) **Date of Patent:** **** Oct. 27, 2020**

(54) **DUST COVER**

2001/0038023 A1* 11/2001 Trevino A45C 13/002
224/153

(71) Applicant: **XIAMEN XINGHENGXING
IMPORT&EXPORT CO., LTD.,**
Xiamen (CN)

* cited by examiner

Primary Examiner — Katrina A Betton

(72) Inventor: **Jiben Wang**, Xiamen (CN)

(57) **CLAIM**

The ornamental design for a dust cover, as shown and described.

(73) Assignee: **XIAMEN XINGHENGXING
IMPORT&EXPORT CO., LTD.,**
Xiamen (CN)

DESCRIPTION

(**) Term: **15 Years**

FIG. 1 is a perspective view of a first embodiment of a dust cover showing my new design;

(21) Appl. No.: **29/737,078**

FIG. 2 is another perspective view thereof;

(22) Filed: **Jun. 5, 2020**

FIG. 3 is a front elevational view thereof;

(51) **LOC (12) Cl.** **06-13**

FIG. 4 is a rear elevational view thereof;

(52) **U.S. Cl.**

FIG. 5 is a left side elevational view thereof;

USPC **D6/610**

FIG. 6 is a right side elevational view thereof;

(58) **Field of Classification Search**

FIG. 7 is a top plan view thereof;

USPC D6/610, 611, 596, 601–603, 615, 617,
D6/621; D7/332, 334–337; D12/195,
D12/222, 401–405, 416

FIG. 8 is a bottom plan view thereof;

CPC B60R 7/043; B60N 2/60

FIG. 9 is a perspective view of a second embodiment of the dust cover;

See application file for complete search history.

FIG. 10 is another perspective view thereof;

(56) **References Cited**

U.S. PATENT DOCUMENTS

D290,678 S *	7/1987	Johnson	D7/387
D396,772 S *	8/1998	Hanzok	D6/610
D430,765 S *	9/2000	Thurston-Chartraw	D6/523
D455,151 S *	4/2002	Lapresca	D14/440
D635,734 S *	4/2011	Rendall	D34/39
D642,848 S *	8/2011	Van Note	D6/610
D692,695 S *	11/2013	Eason	D6/610
D702,973 S *	4/2014	Norland	D6/610
D819,368 S *	6/2018	Zemel	D6/610
D858,144 S *	9/2019	Fu	D6/610
D884,390 S	5/2020	Wang		
D884,391 S *	5/2020	Wang	D6/610
D888,439 S	6/2020	Wang		

FIG. 11 is a front elevational view thereof;

FIG. 12 is a rear elevational view thereof;

FIG. 13 is a left side elevational view thereof;

FIG. 14 is a right side elevational view thereof;

FIG. 15 is a top plan view thereof;

FIG. 16 is a bottom plan view thereof;

FIG. 17 is a perspective view of a third embodiment of the dust cover;

FIG. 18 is another perspective view thereof;

FIG. 19 is a front elevational view thereof;

FIG. 20 is a rear elevational view thereof;

FIG. 21 is a left side elevational view thereof;

FIG. 22 is a right side elevational view thereof;

FIG. 23 is a top plan view thereof; and,

FIG. 24 is a bottom plan view thereof.

The broken lines in the drawings depict portions of the dust cover that form no part of the claimed design.

1 Claim, 24 Drawing Sheets

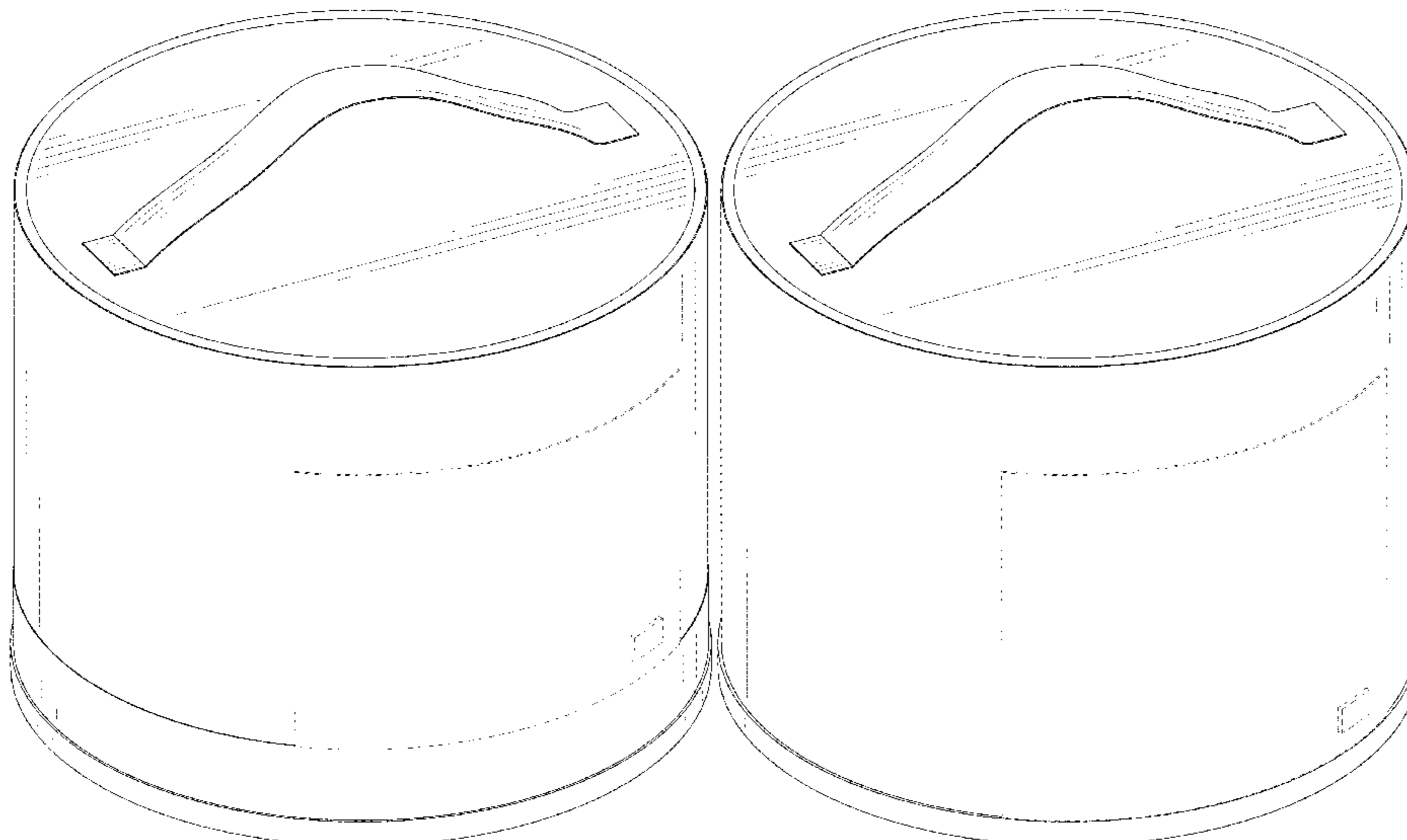

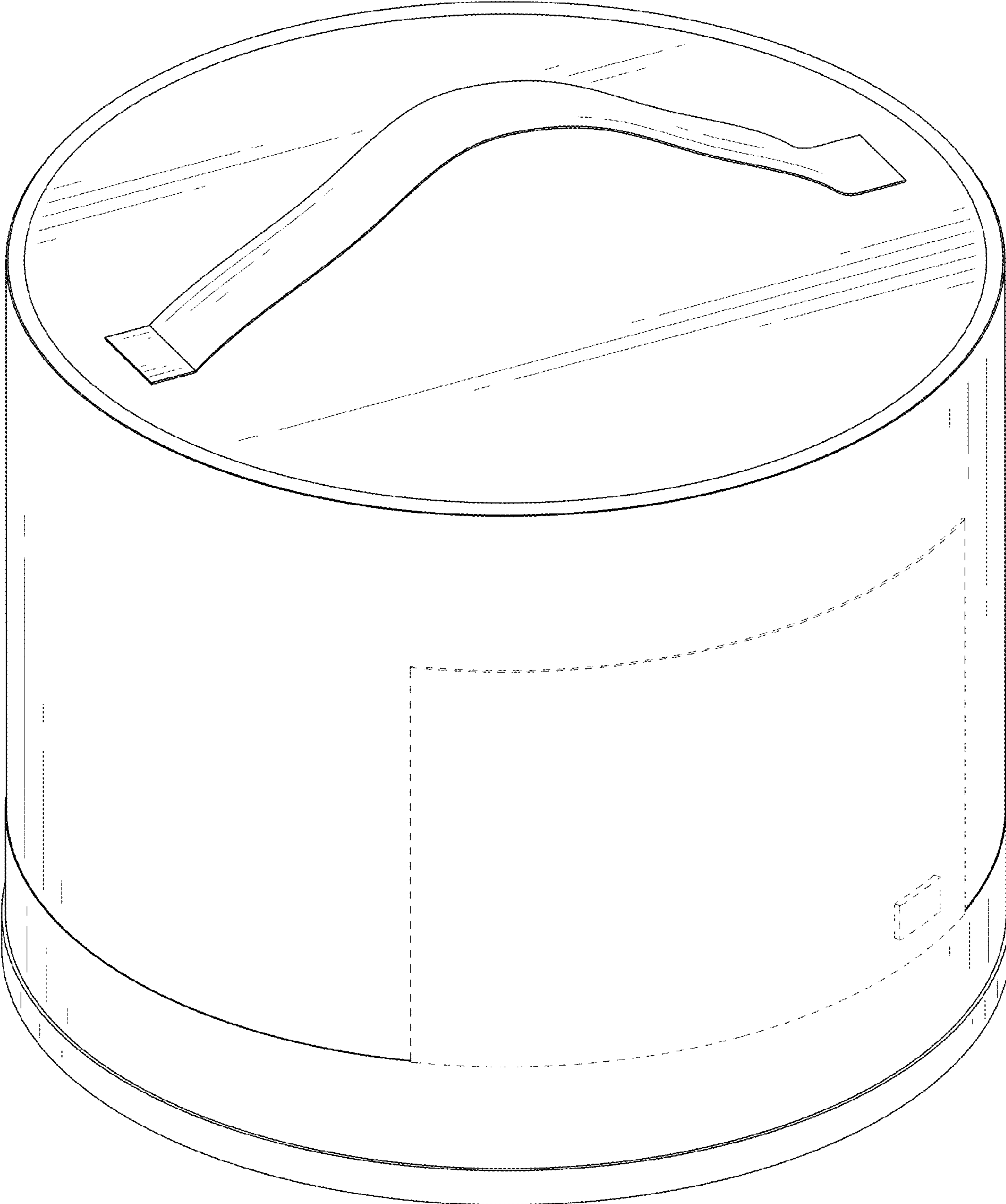

FIG. 1

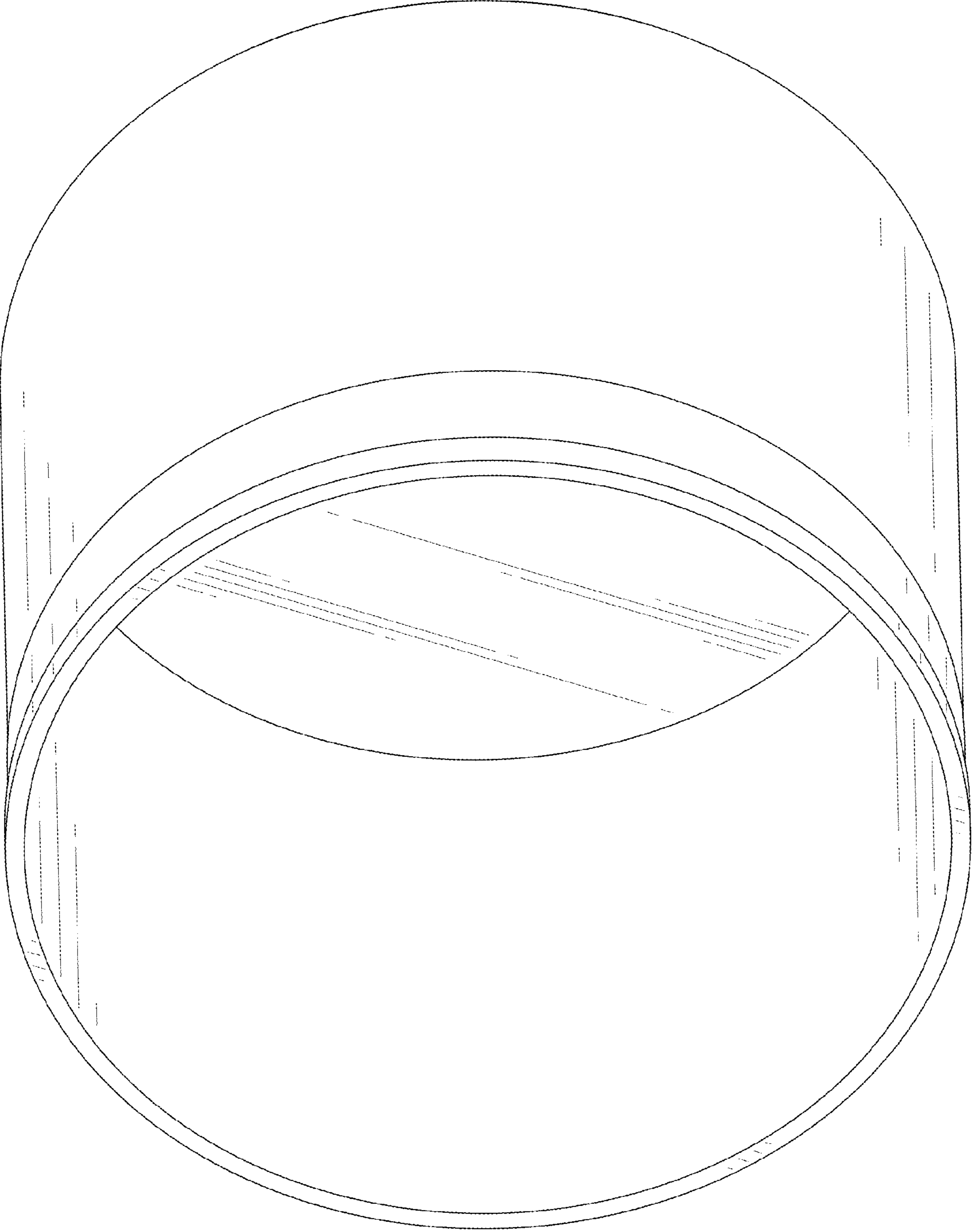

FIG. 2

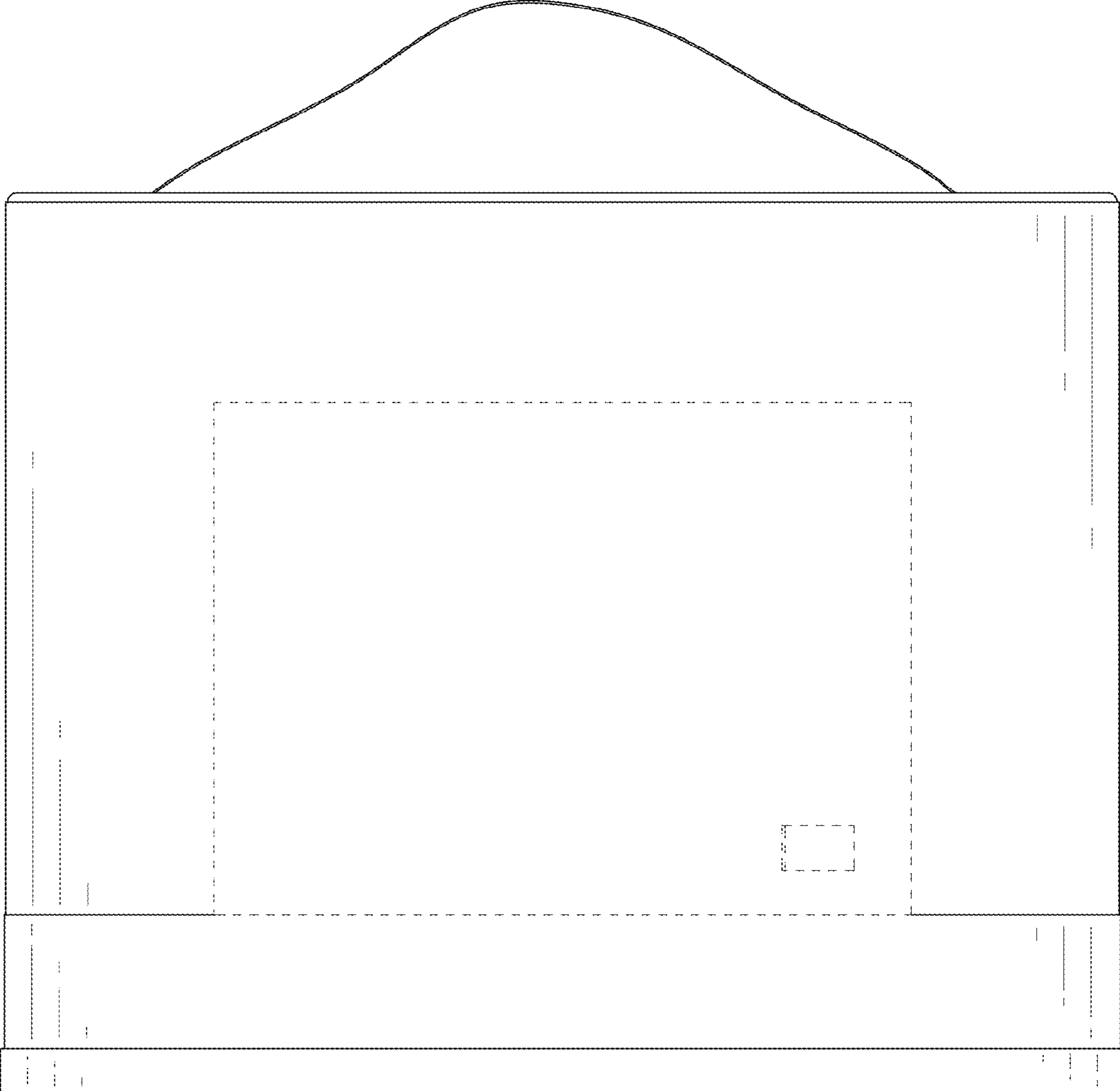

FIG. 3

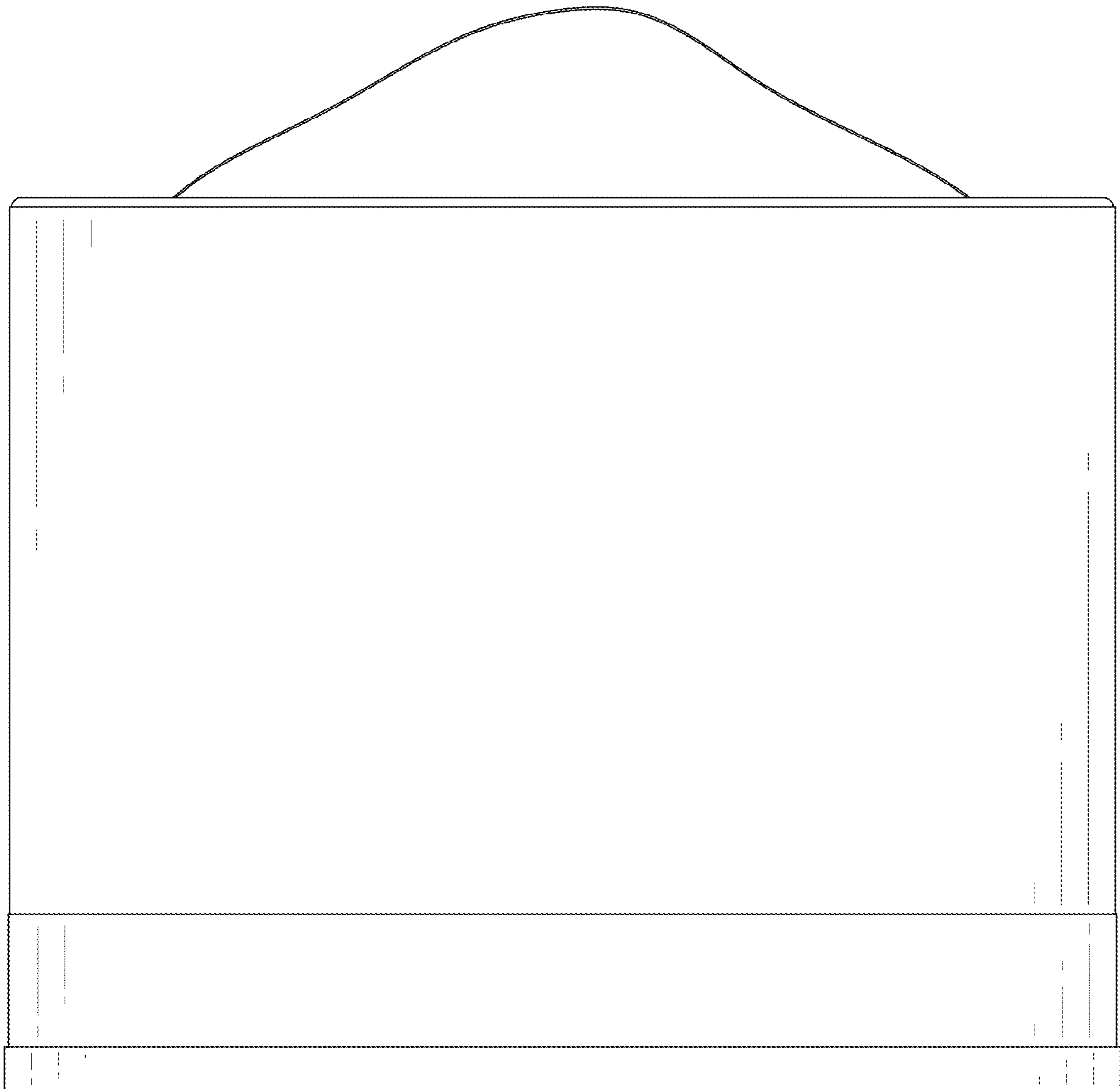

FIG. 4

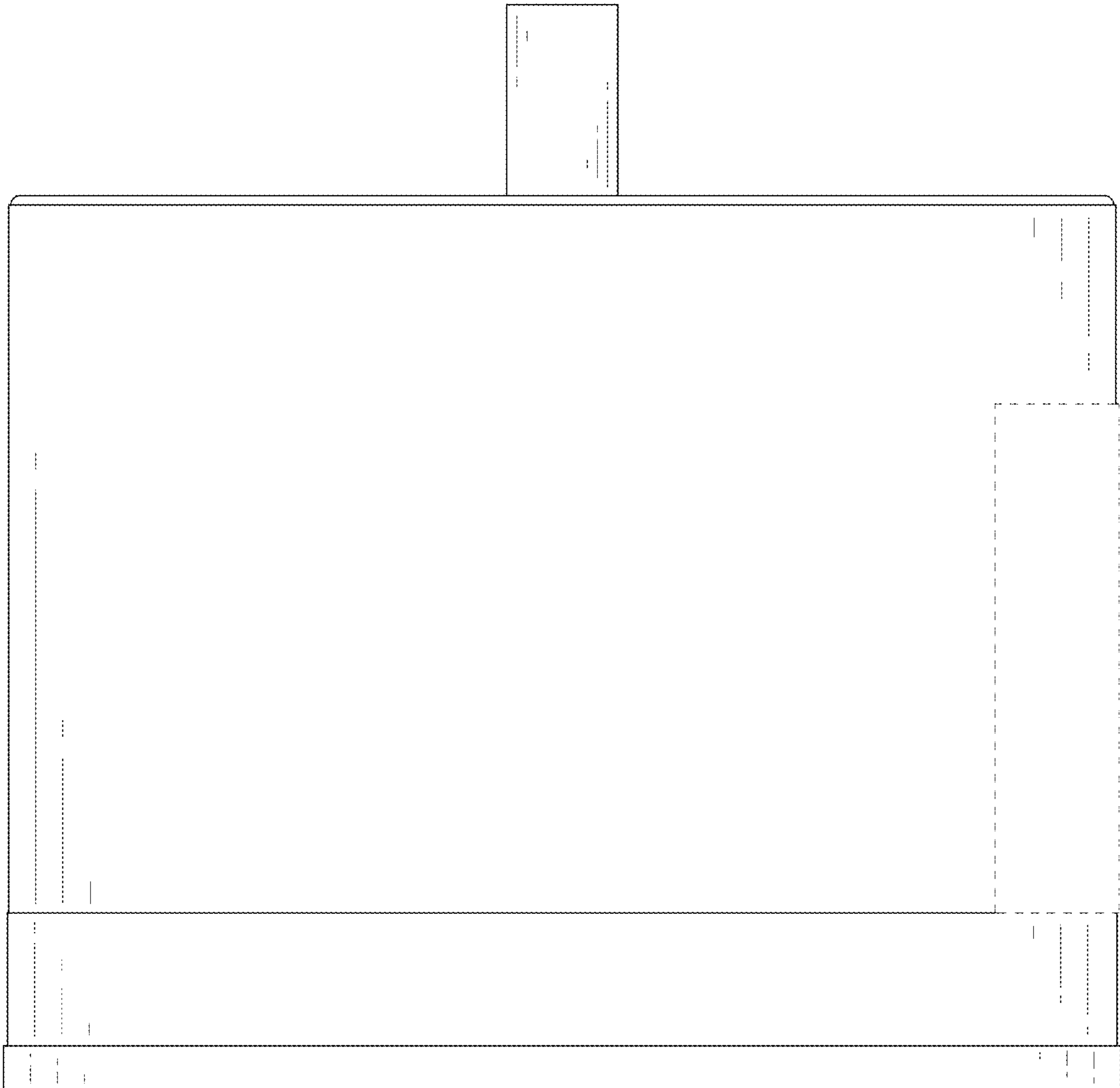

FIG. 5

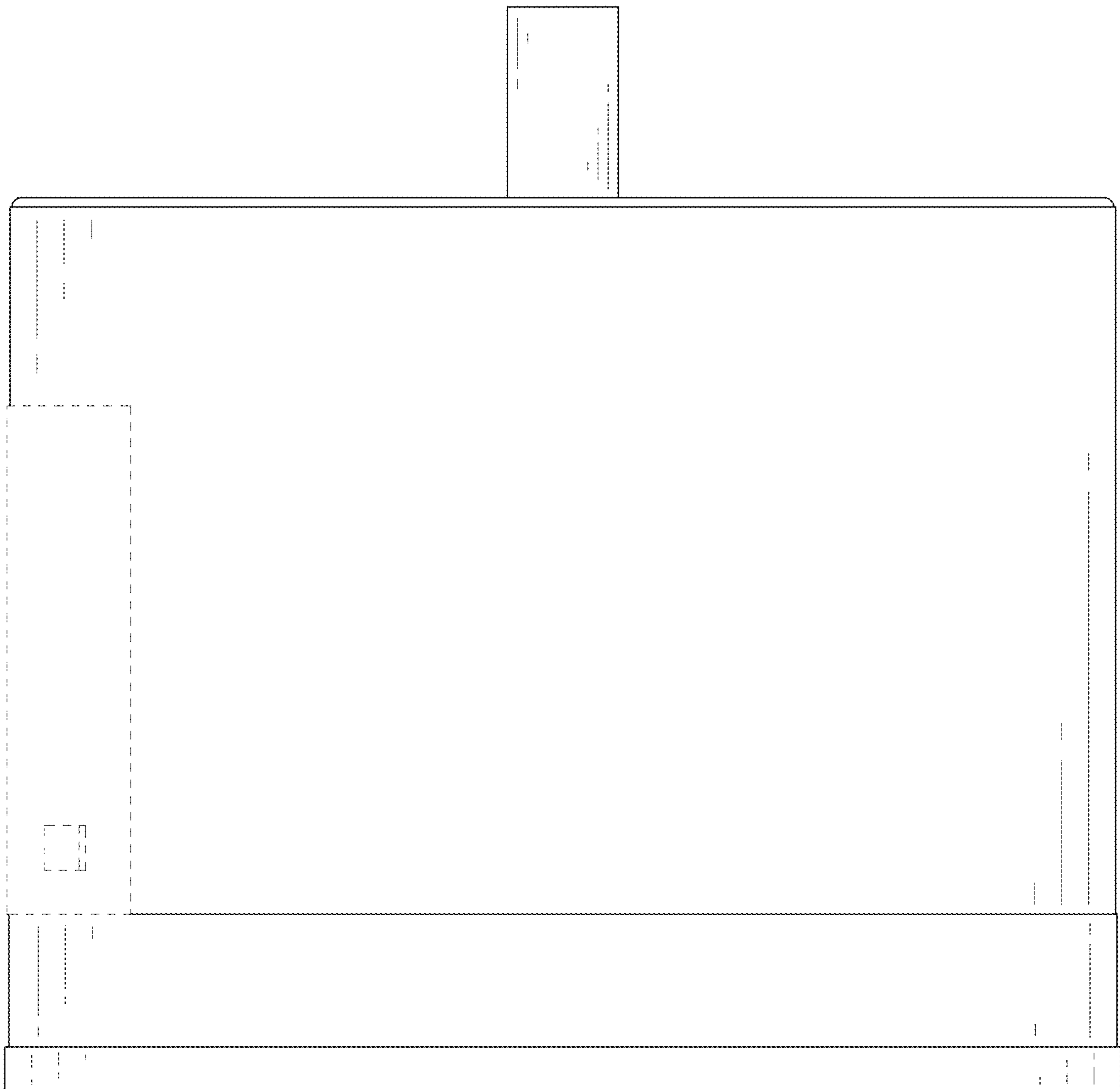

FIG. 6

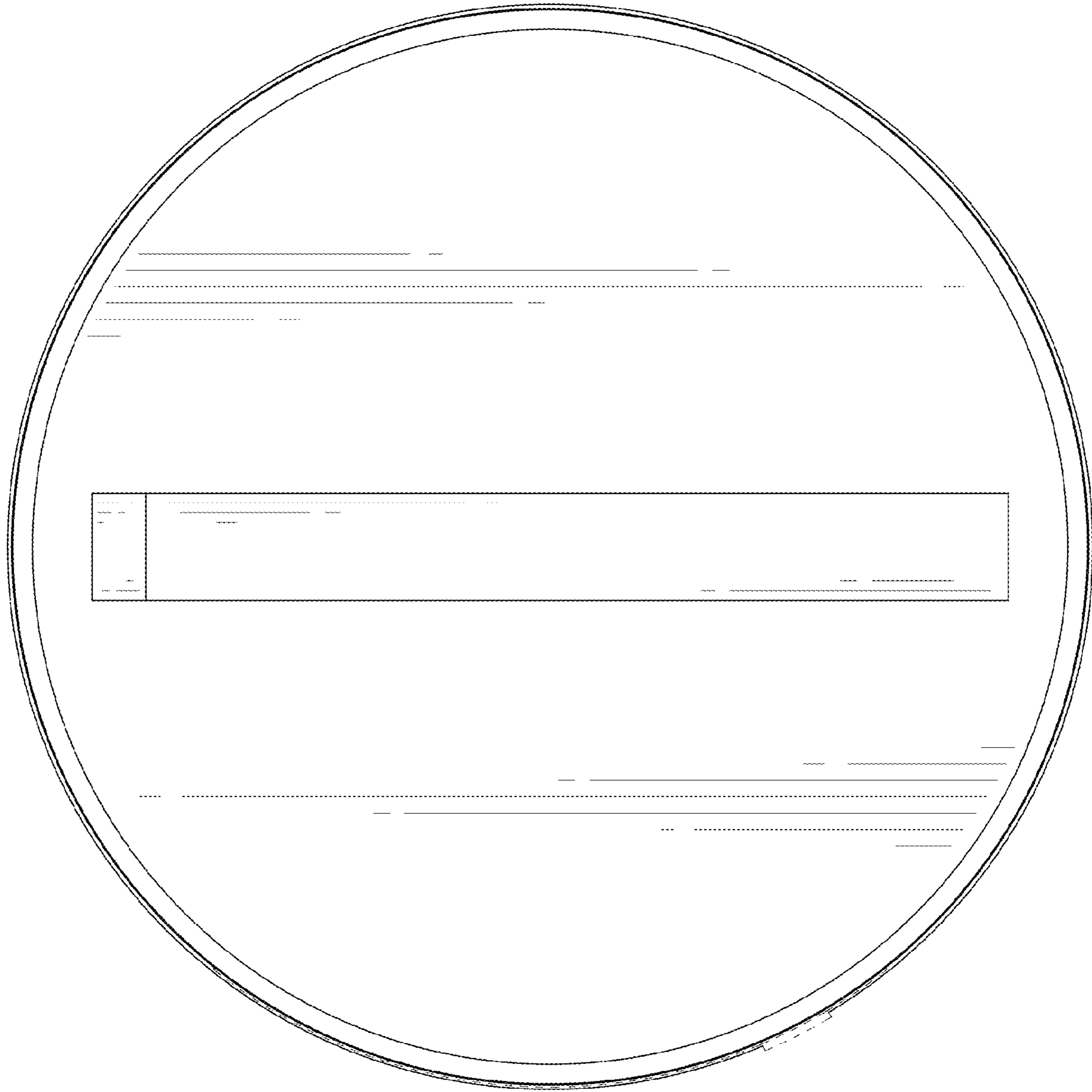

FIG. 7

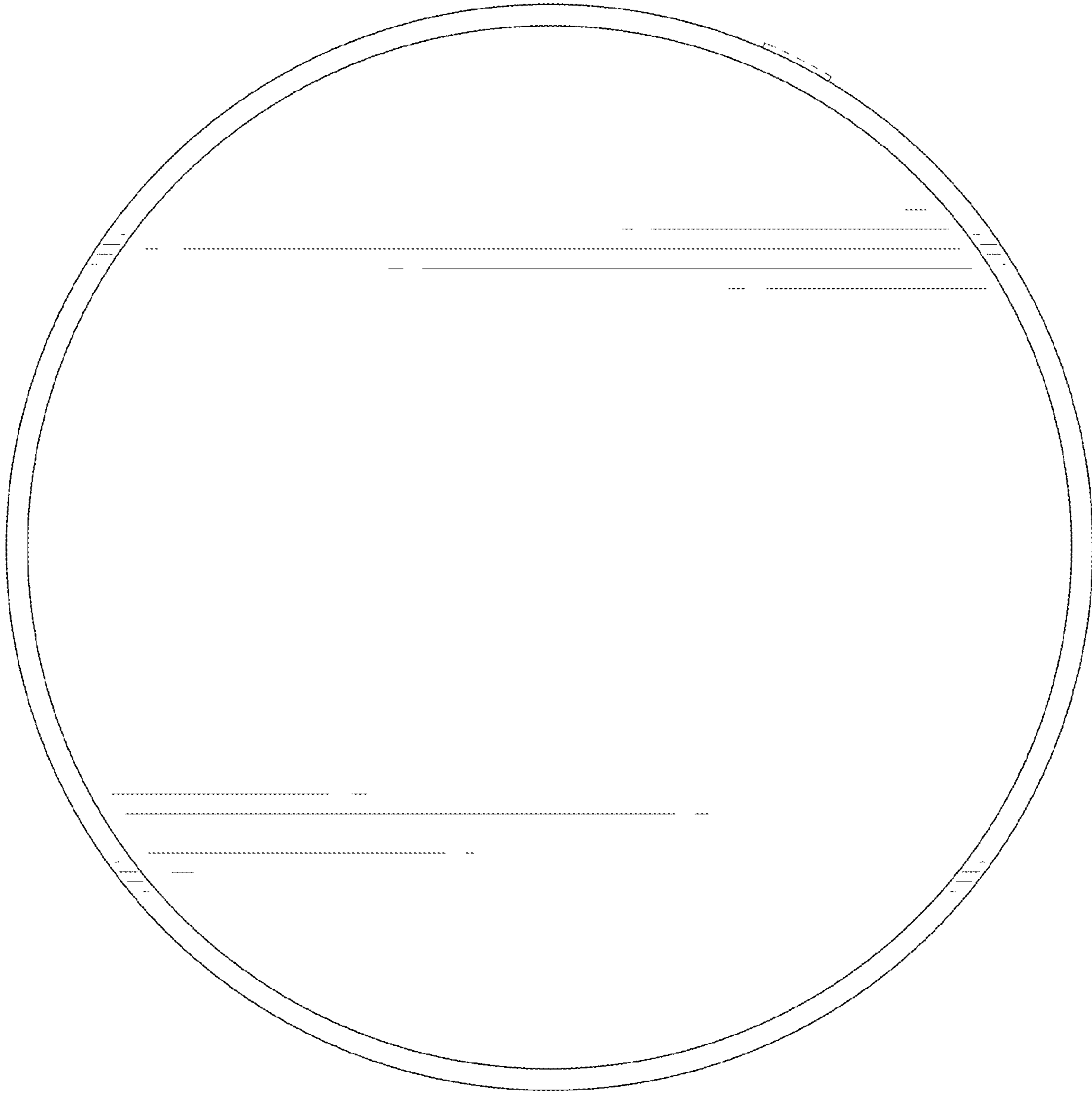

FIG. 8

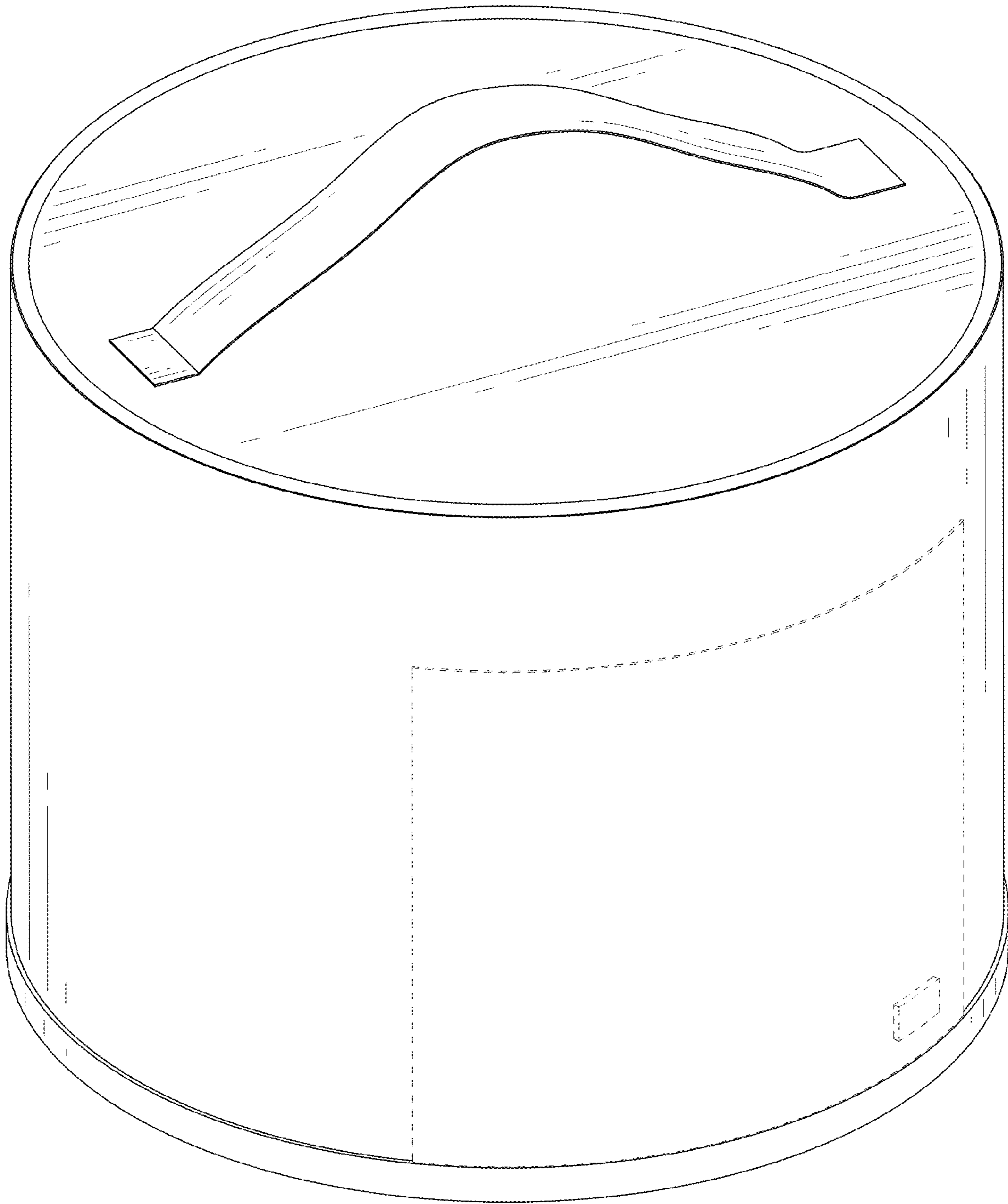

FIG. 9

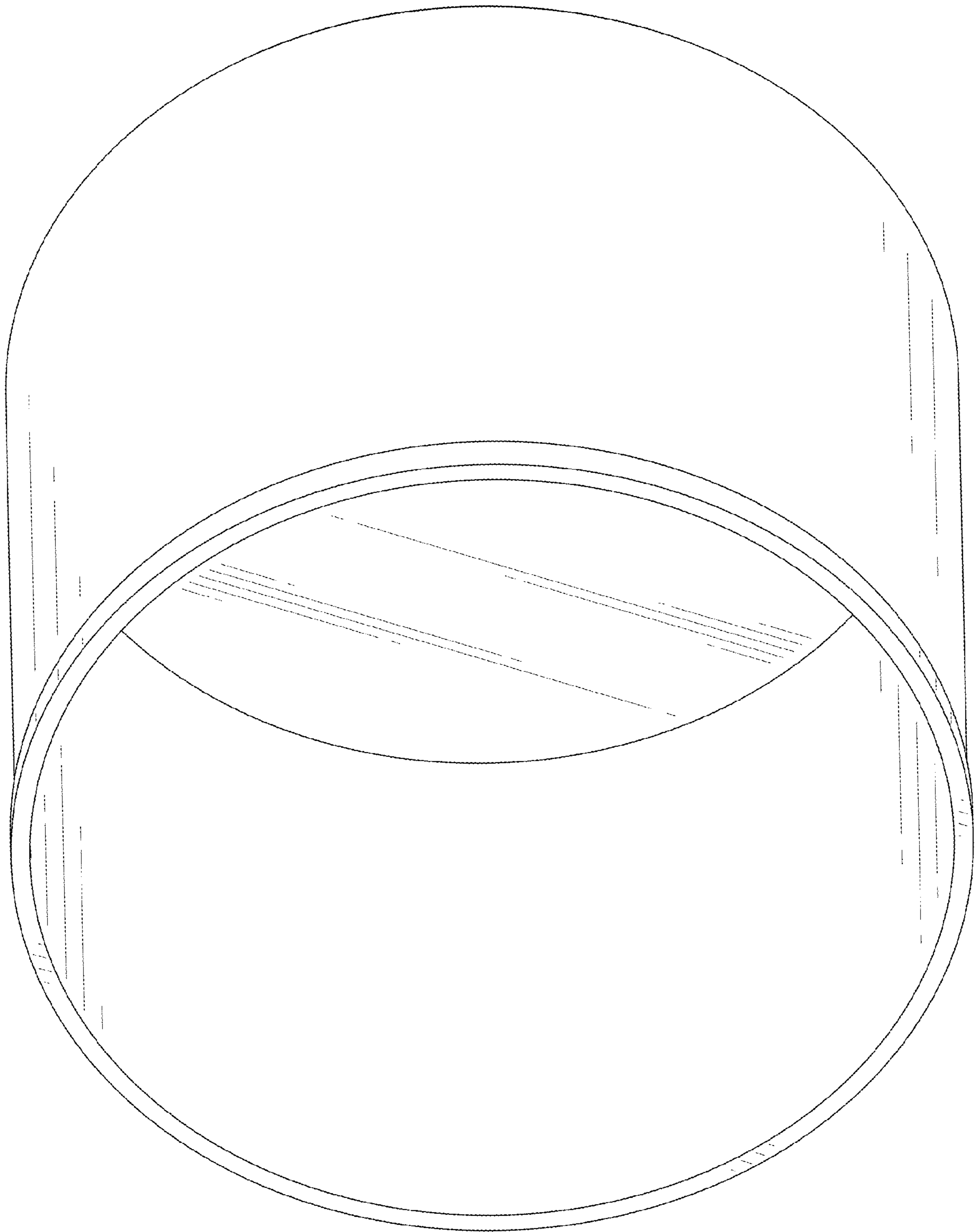

FIG. 10

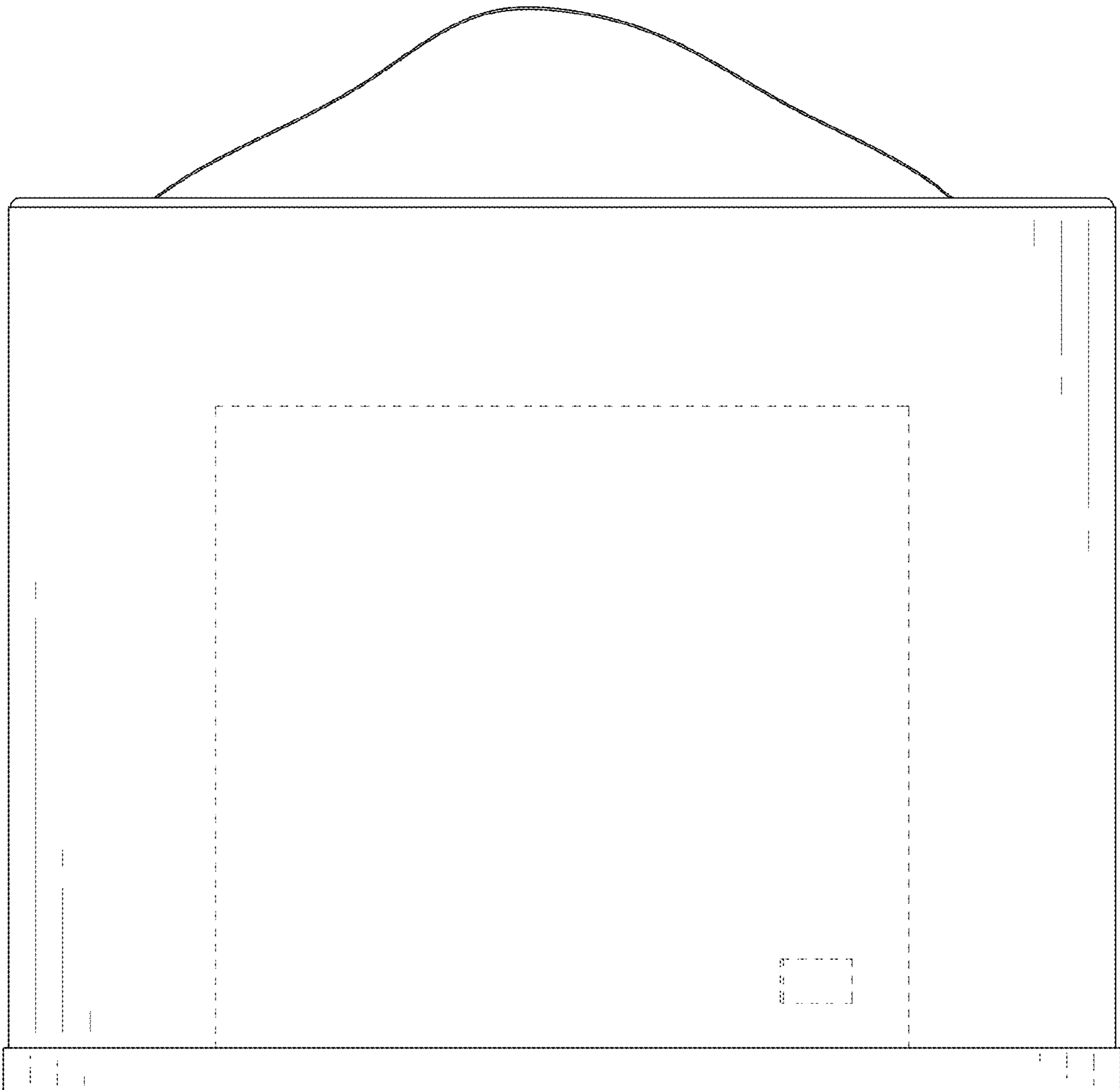

FIG. 11

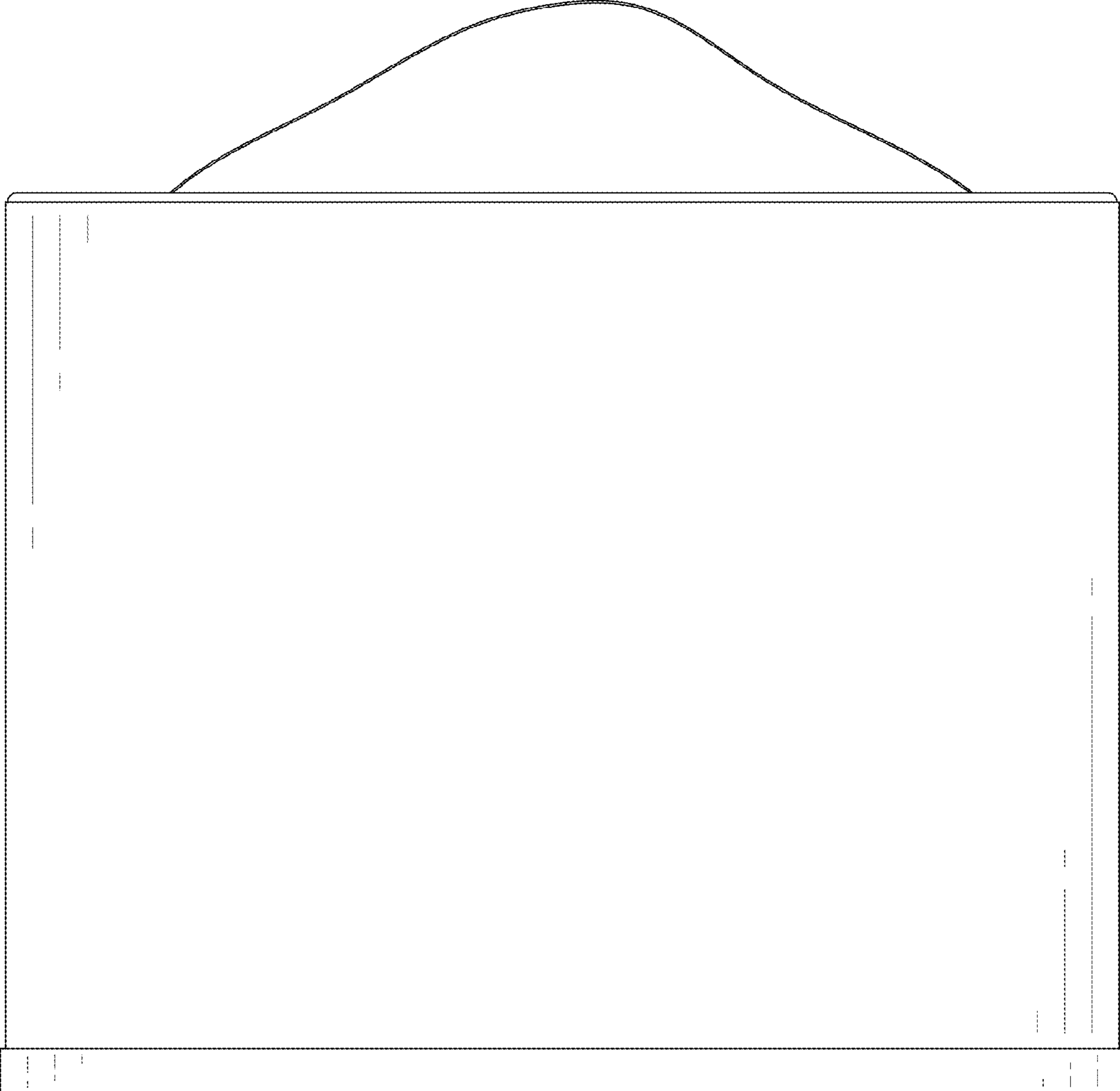

FIG. 12

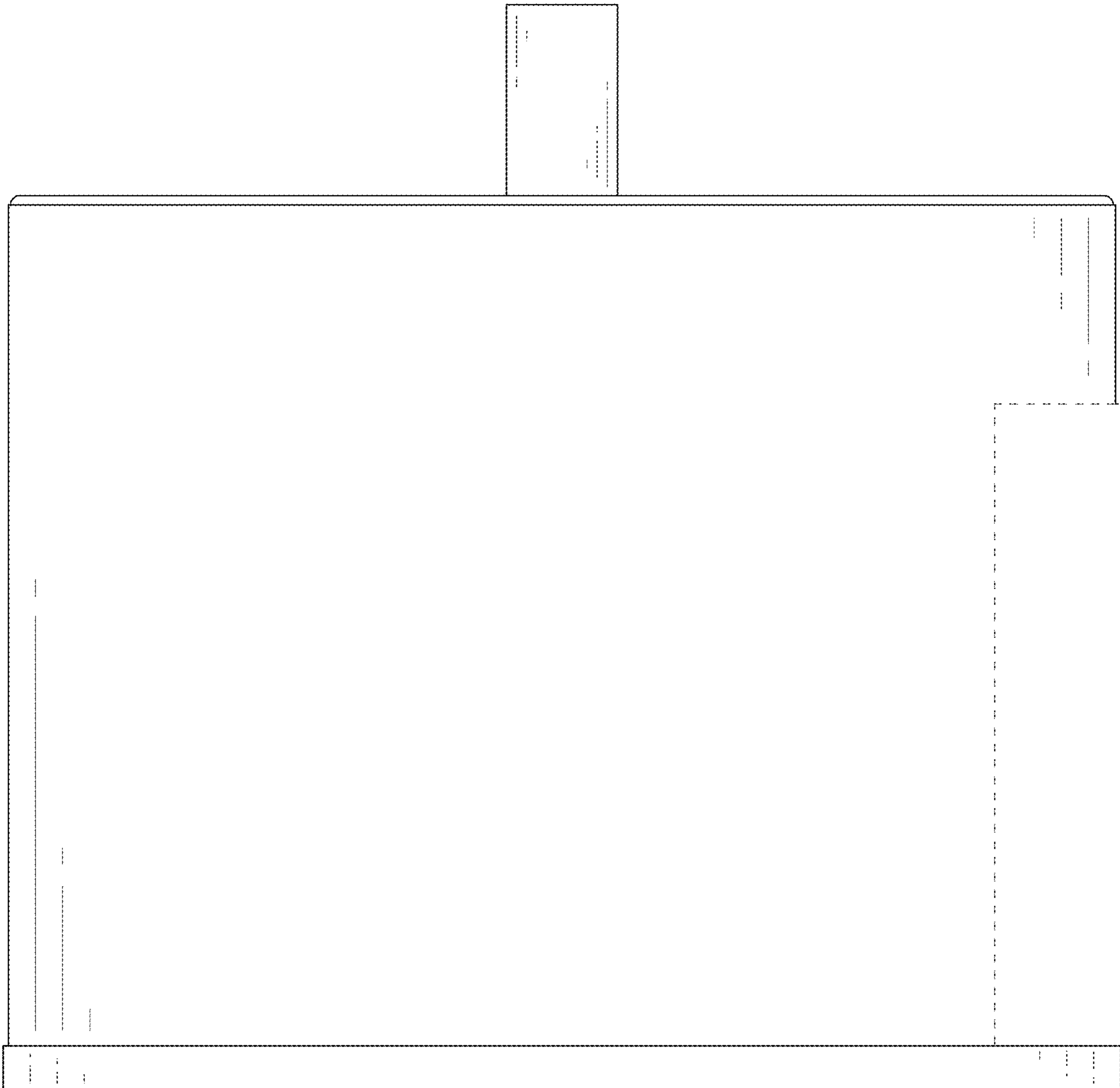

FIG. 13

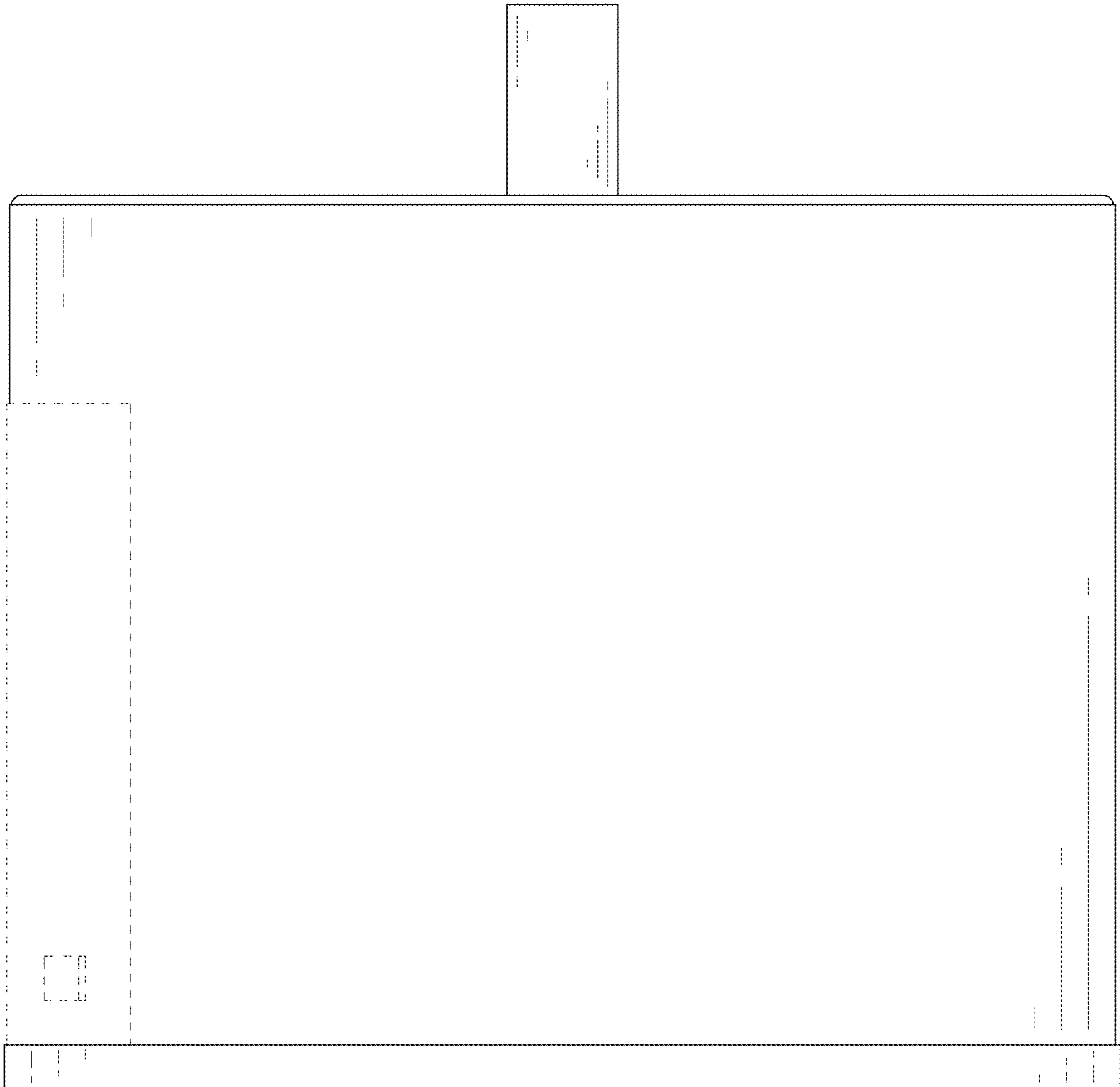

FIG. 14

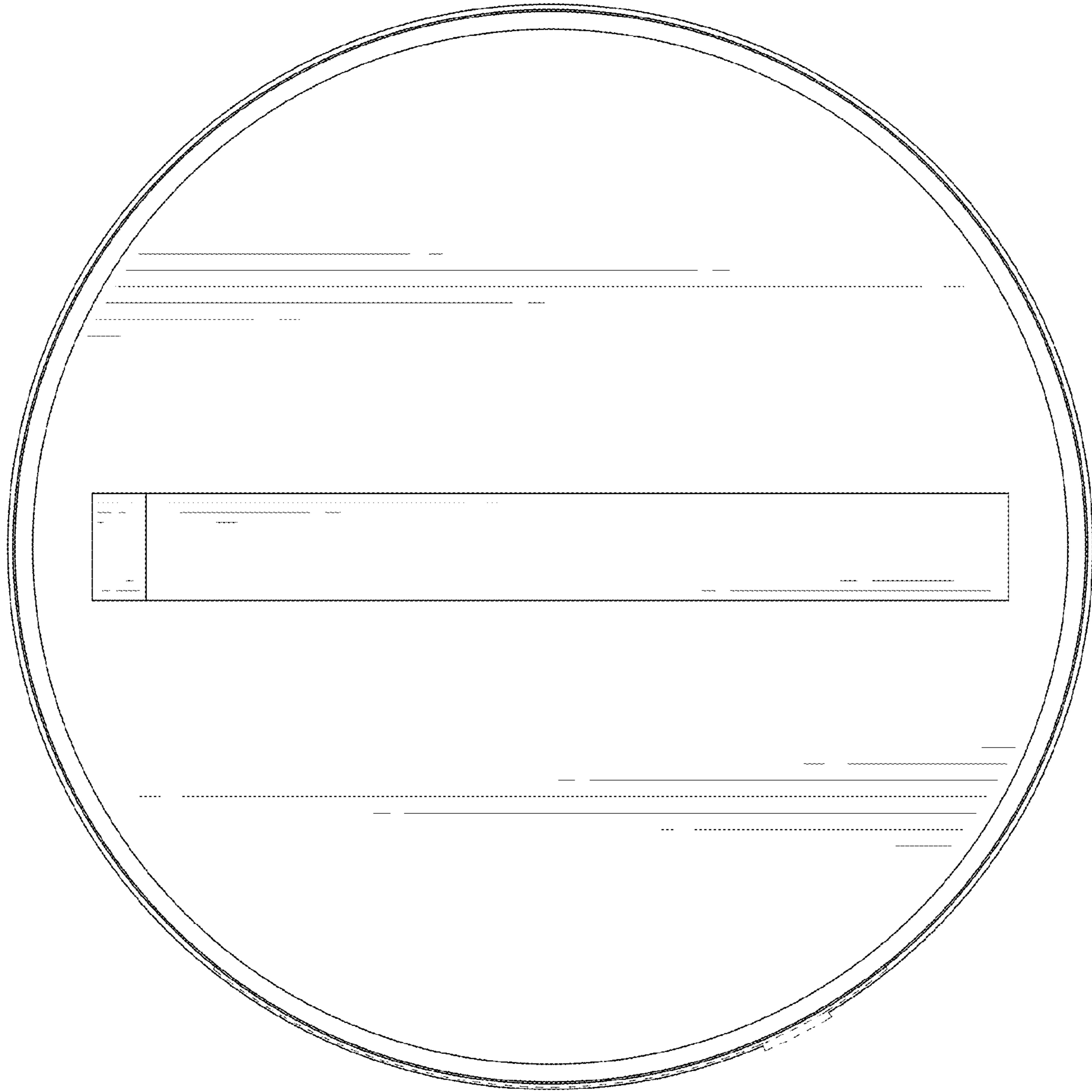

FIG. 15

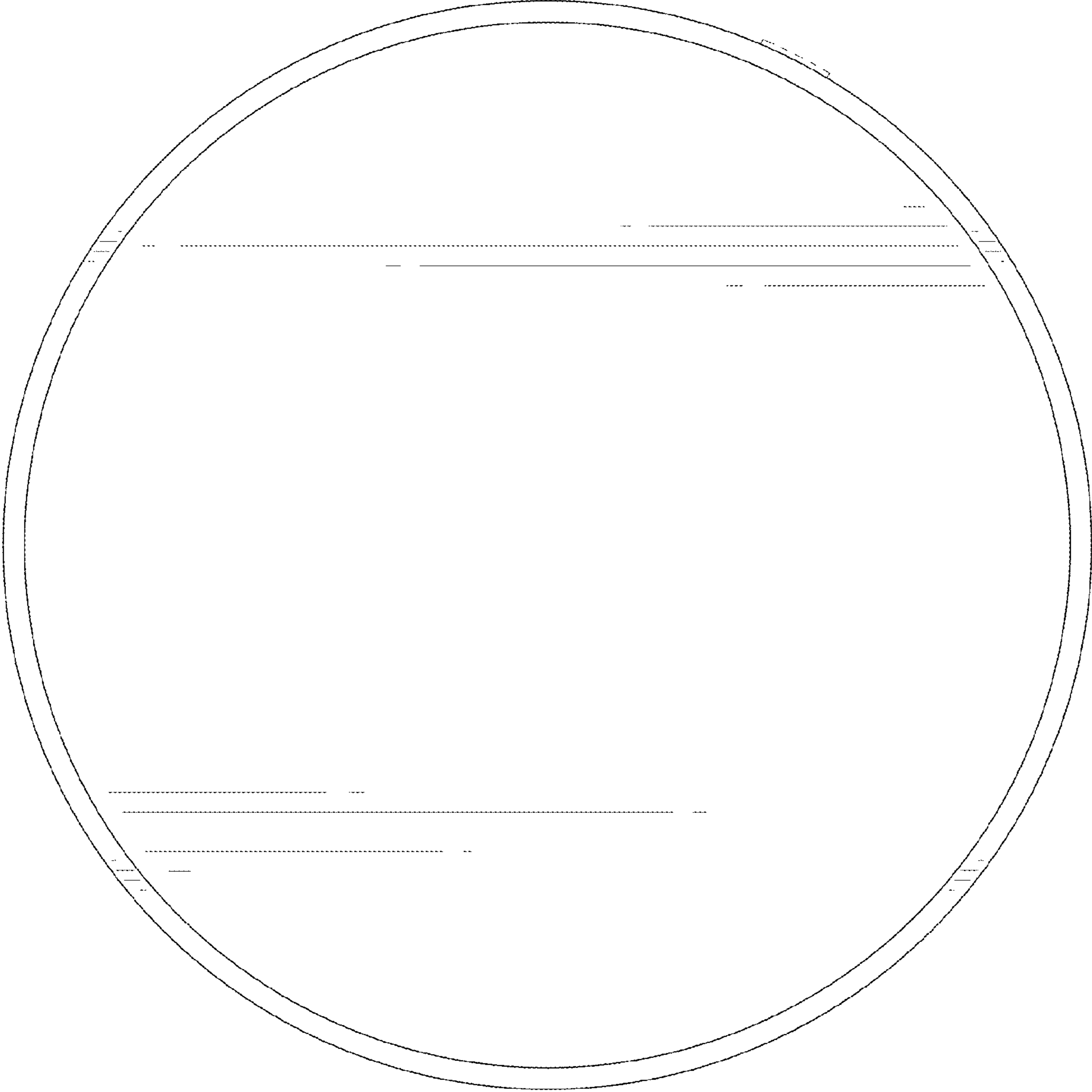

FIG. 16

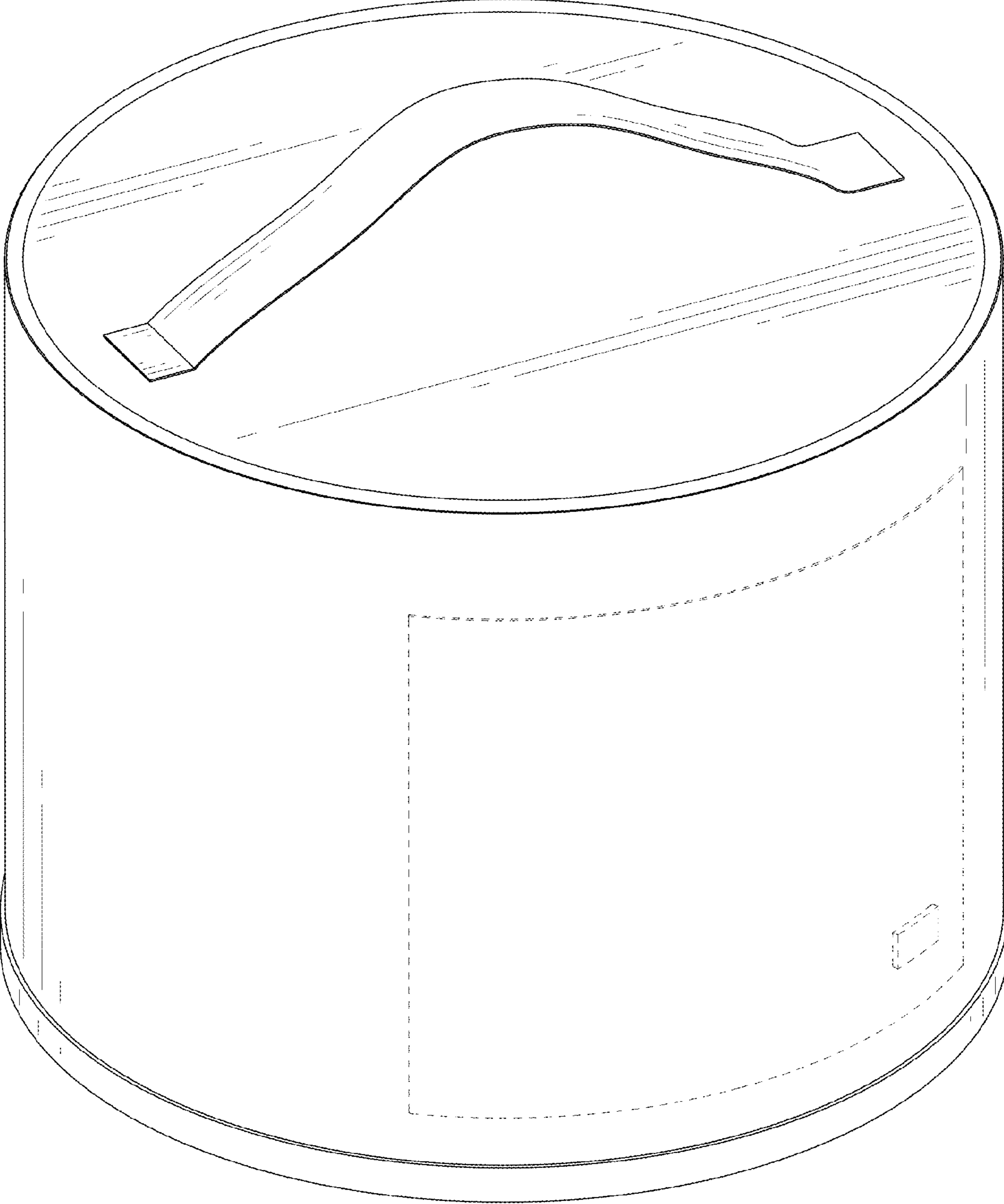

FIG. 17

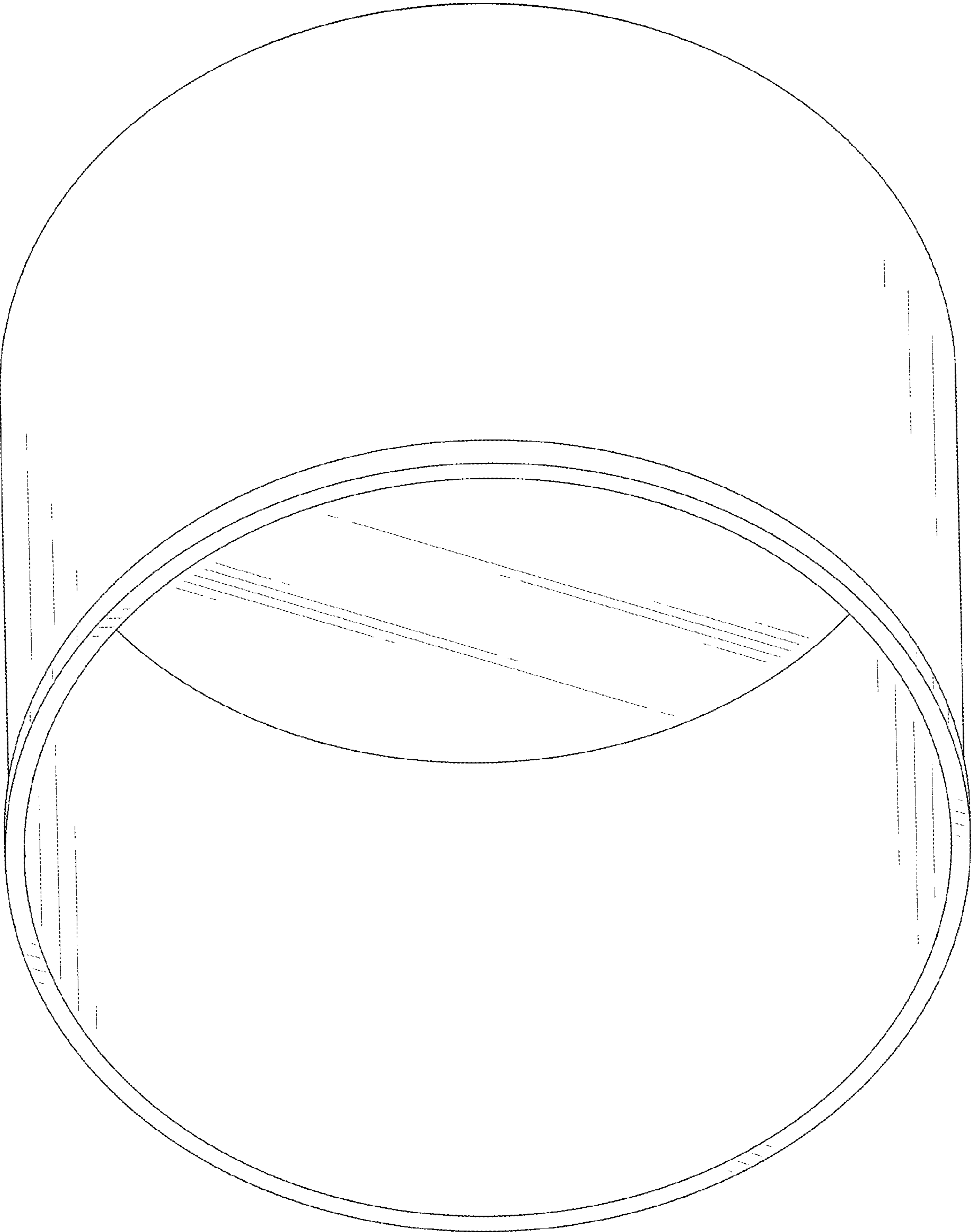

FIG. 18

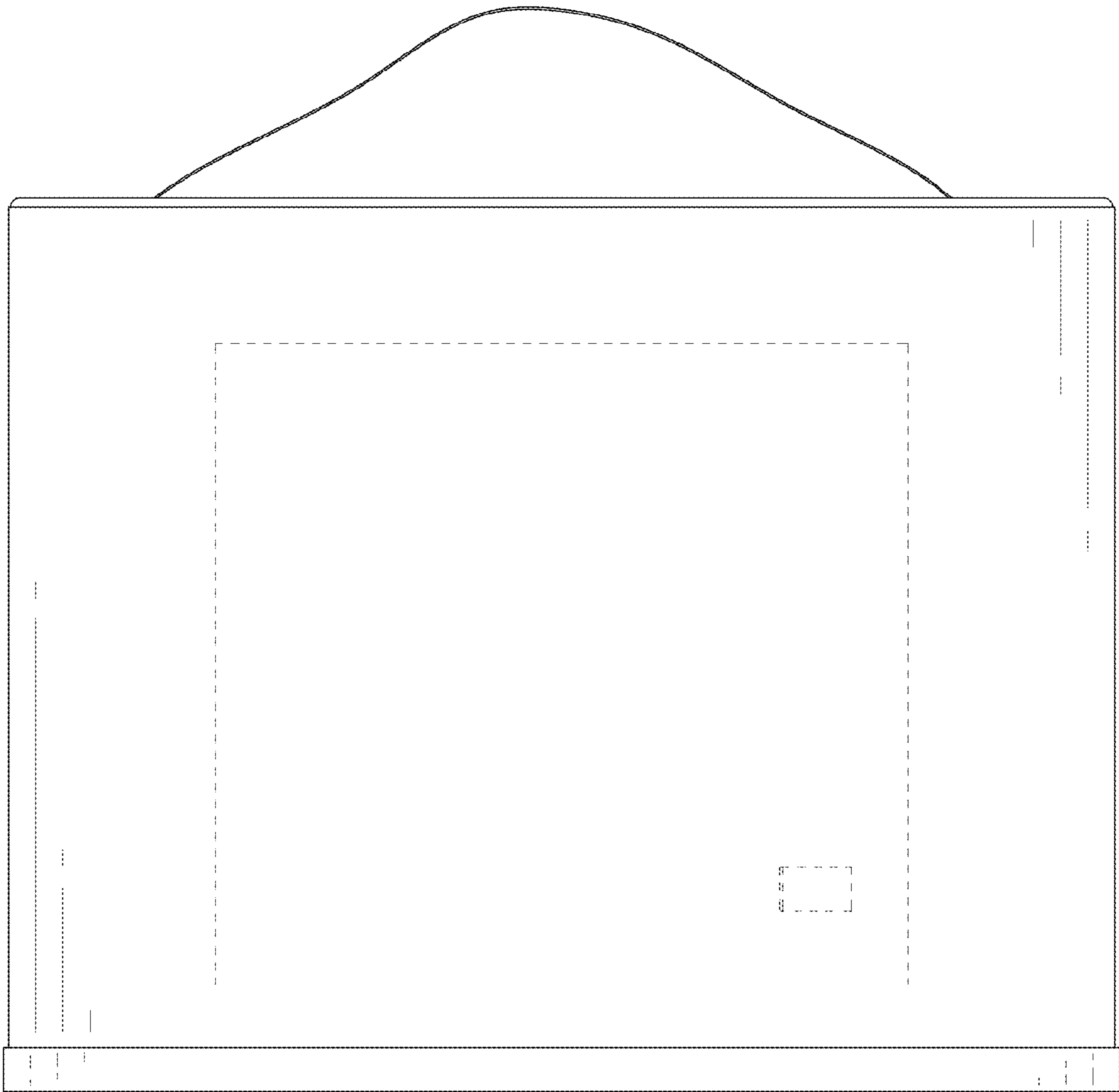

FIG. 19

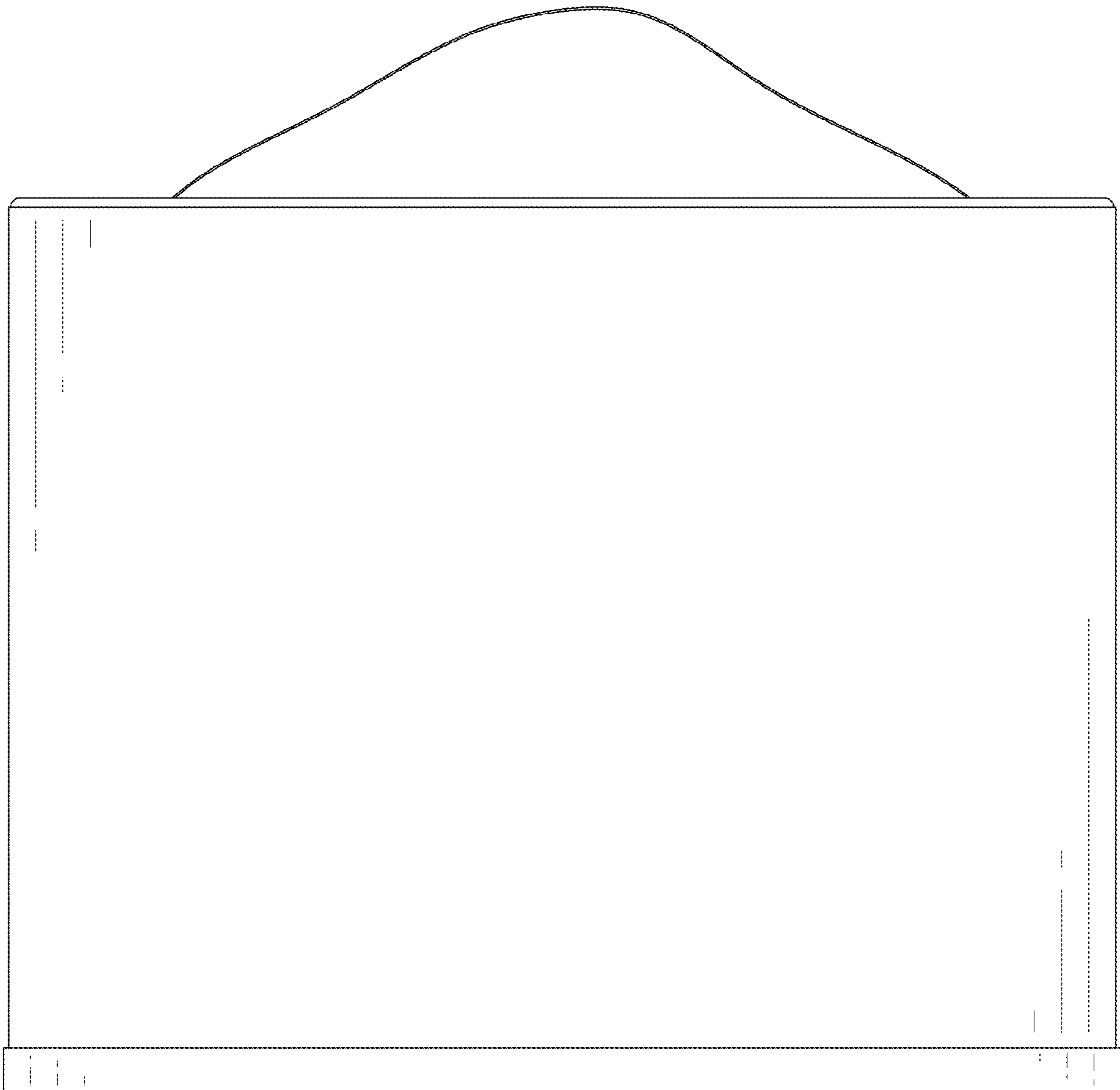

FIG. 20

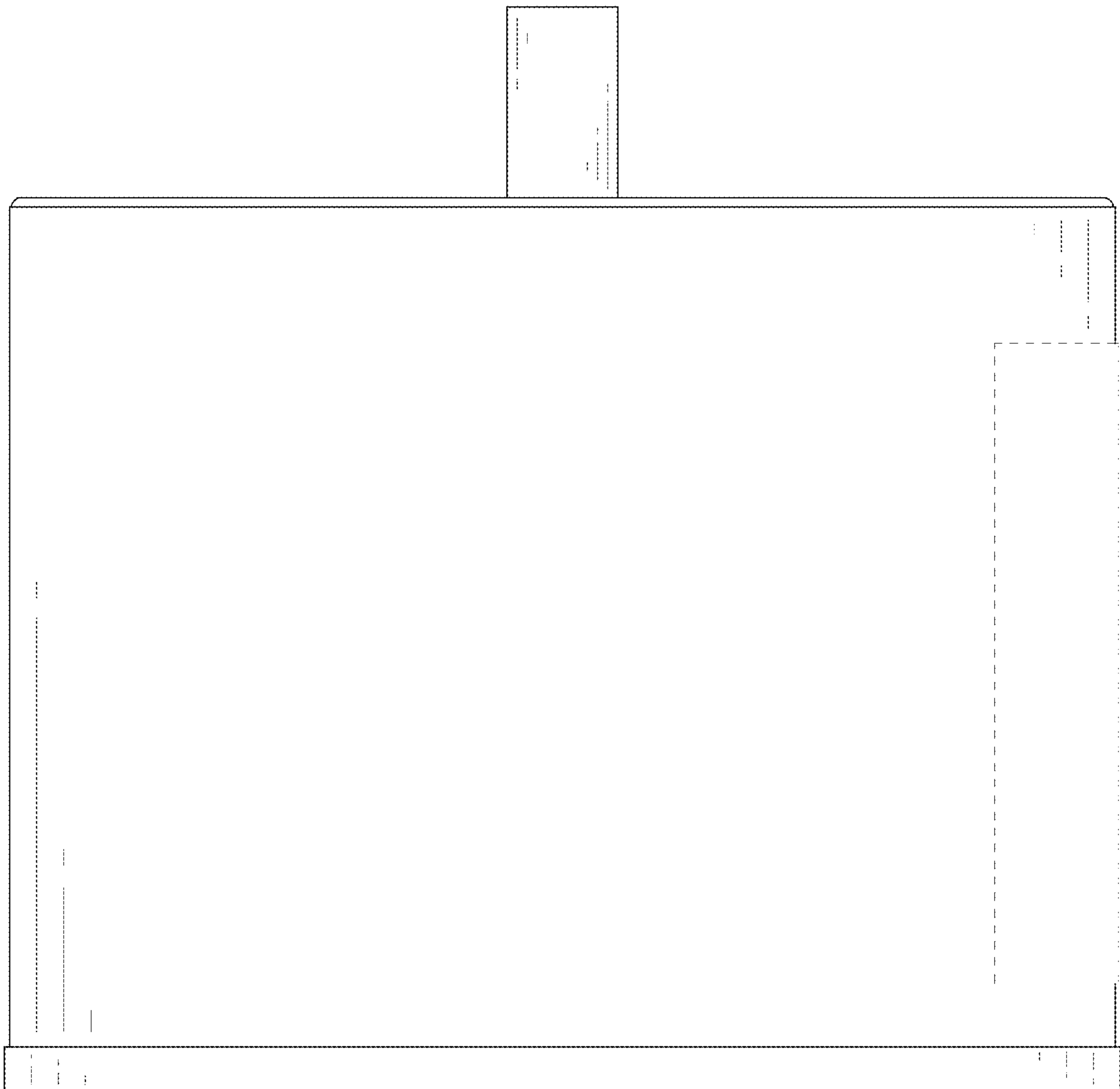

FIG. 21

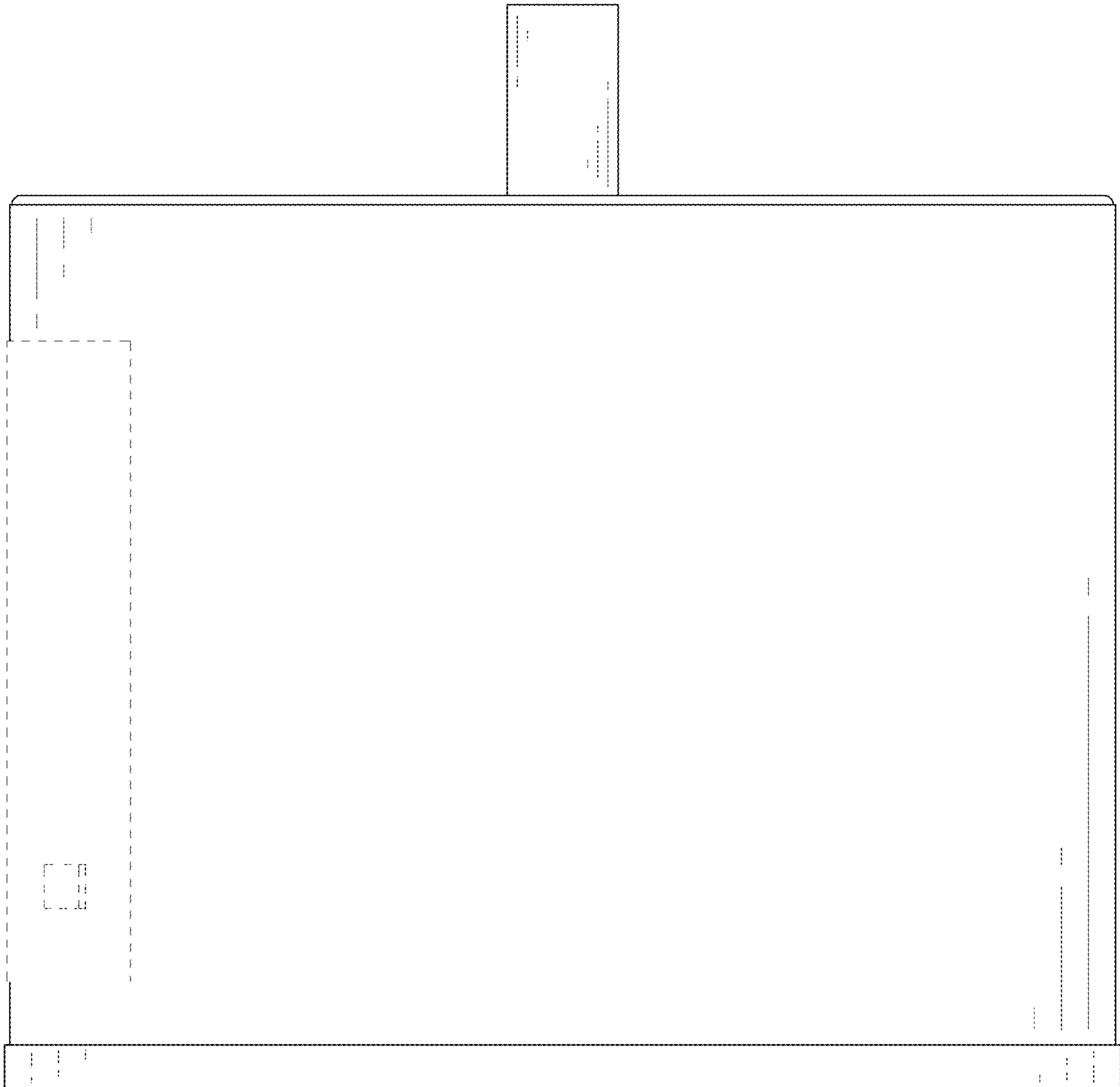

FIG. 22

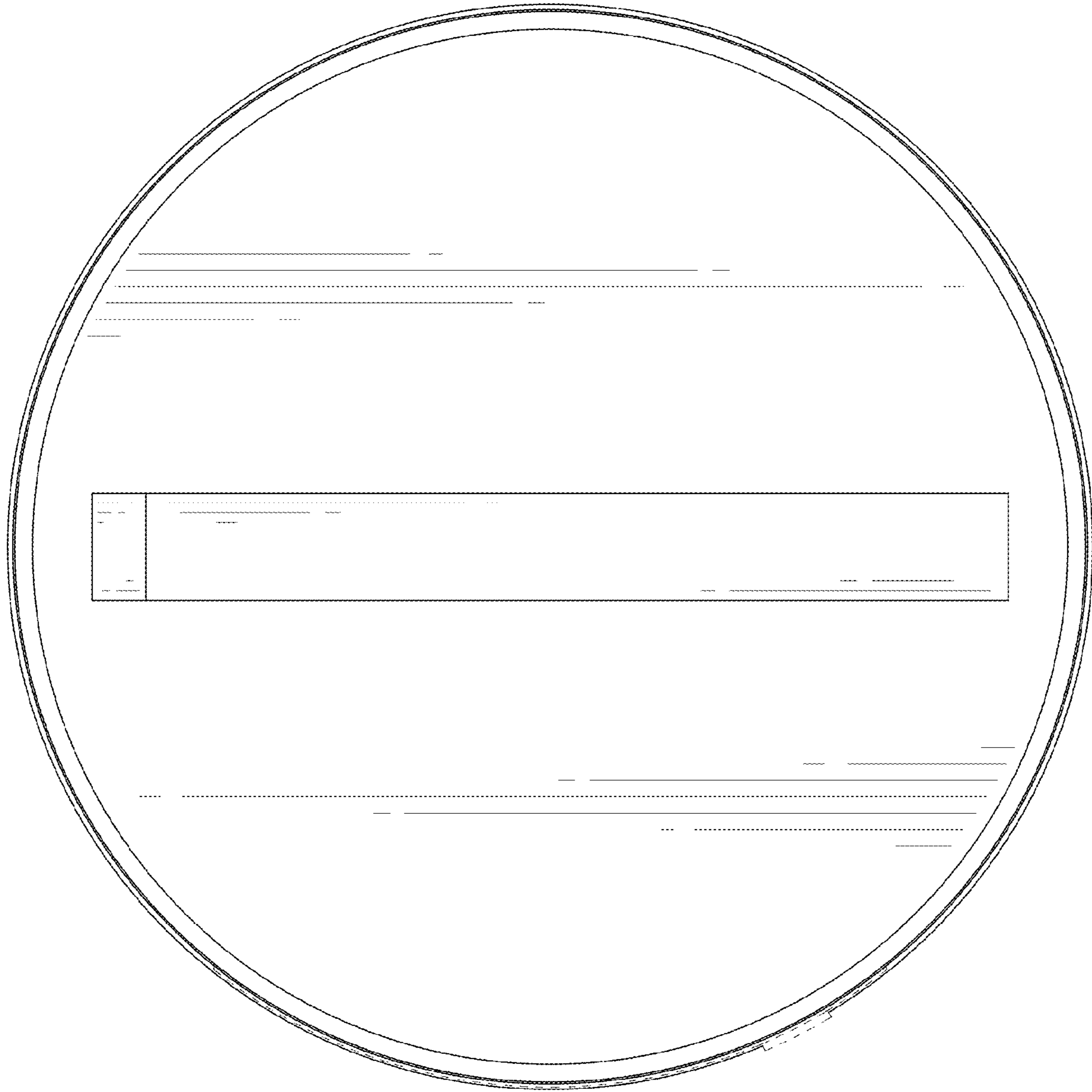

FIG. 23

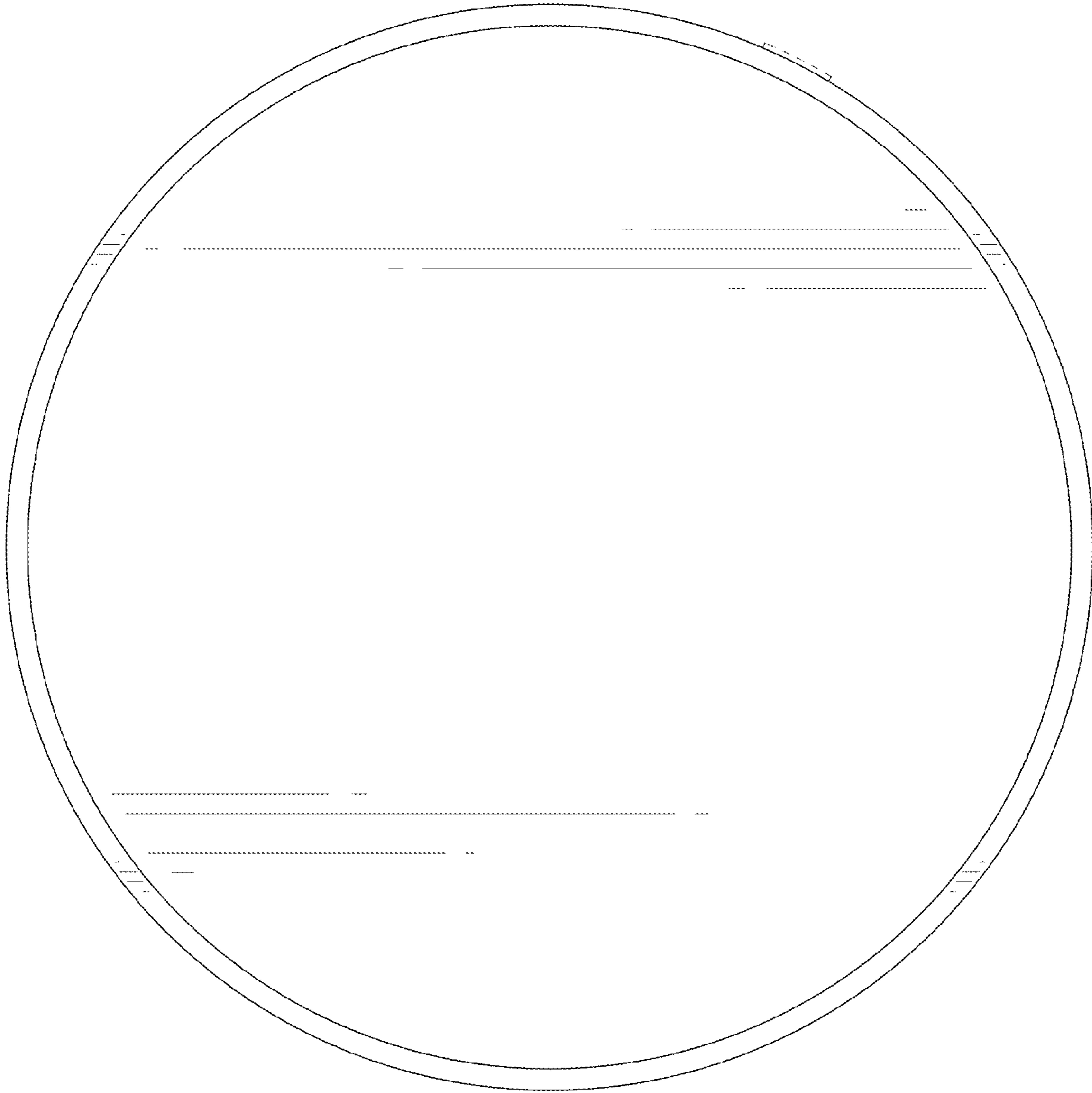

FIG. 24