



US00D899778S

(12) **United States Design Patent**
Hedaya

(10) **Patent No.:** **US D899,778 S**
(45) **Date of Patent:** **** Oct. 27, 2020**

(54) **BACKPACK WITH AN INSERT ARRANGEMENT**

(71) Applicant: **Fast Forward LLC**, New York, NY (US)

(72) Inventor: **Evan Hedaya**, Brooklyn, NY (US)

(73) Assignee: **FAST FORWARD LLC**, New York, NY (US)

(**) Term: **15 Years**

(21) Appl. No.: **29/701,178**

(22) Filed: **Aug. 8, 2019**

(51) **LOC (12) Cl.** **03-01**

(52) **U.S. Cl.**
USPC **D3/319**

(58) **Field of Classification Search**
USPC D3/216-217, 318-319

(Continued)

(56) **References Cited**

U.S. PATENT DOCUMENTS

D446,008 S * 8/2001 Schulze D3/216
D615,275 S * 5/2010 Hacker D99/43

(Continued)

Primary Examiner — Holly H Baynham

(74) *Attorney, Agent, or Firm* — Leason Ellis LLP

(57) **CLAIM**

The ornamental design for a backpack with an insert arrangement, as shown and described.

DESCRIPTION

FIG. 1 is a perspective view of a first embodiment of a backpack with an insert arrangement showing my new ornamental design;

FIG. 2 is a rear plan view thereof;

FIG. 3 is a front plan view thereof;

FIG. 4 is a right-side view thereof;

FIG. 5 is a left-side view thereof;

FIG. 6 is a top view thereof;

FIG. 7 is a bottom view thereof;

FIG. 8 is a perspective view of a second embodiment of a backpack with an insert arrangement showing my new ornamental design;

FIG. 9 is a rear plan view thereof;

FIG. 10 is a front plan view thereof;

FIG. 11 is a right-side view thereof;

FIG. 12 is a left-side view thereof;

FIG. 13 is a top view thereof;

FIG. 14 is a bottom view thereof;

FIG. 15 is a perspective view of a third embodiment of a backpack with an insert arrangement showing my new ornamental design;

FIG. 16 is a rear plan view thereof;

FIG. 17 is a front plan view thereof;

FIG. 18 is a right-side view thereof;

FIG. 19 is a left-side view thereof;

FIG. 20 is a top view thereof;

FIG. 21 is a bottom view thereof;

FIG. 22 is a perspective view of a fourth embodiment of a backpack with an insert arrangement showing my new ornamental design;

FIG. 23 is a rear plan view thereof;

FIG. 24 is a front plan view thereof;

FIG. 25 is a right-side view thereof;

FIG. 26 is a left-side view thereof;

FIG. 27 is a top view thereof;

FIG. 28 is a bottom view thereof;

FIG. 29 is a perspective view of a fifth embodiment of a backpack with an insert arrangement showing my new ornamental design;

FIG. 30 is a rear plan view thereof;

FIG. 31 is a front plan view thereof;

FIG. 32 is a right-side view thereof;

FIG. 33 is a left-side view thereof;

FIG. 34 is a top view thereof;

FIG. 35 is a bottom view thereof;

FIG. 36 is a perspective view of a sixth embodiment of a backpack with an insert arrangement showing my new ornamental design;

(Continued)

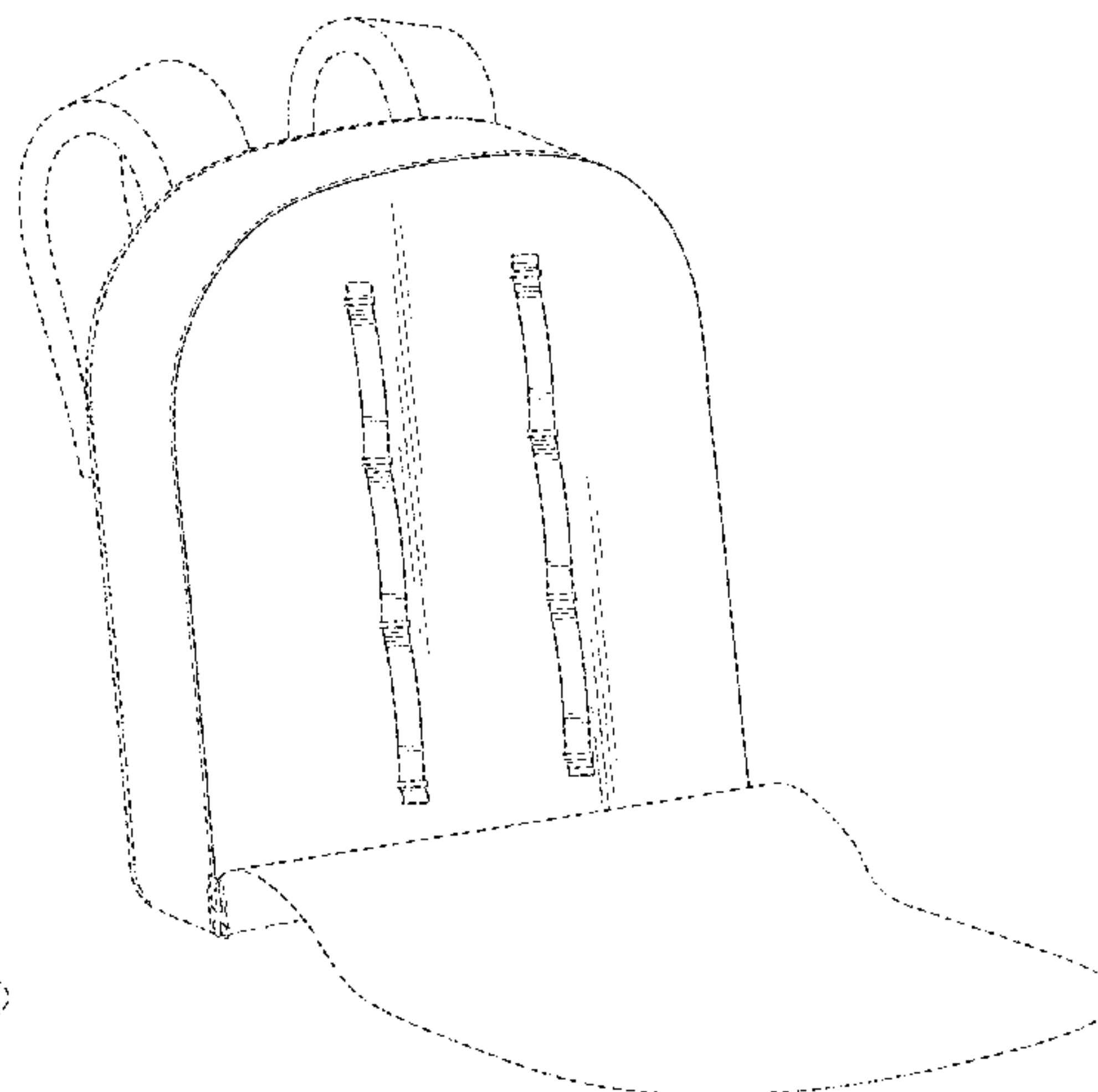
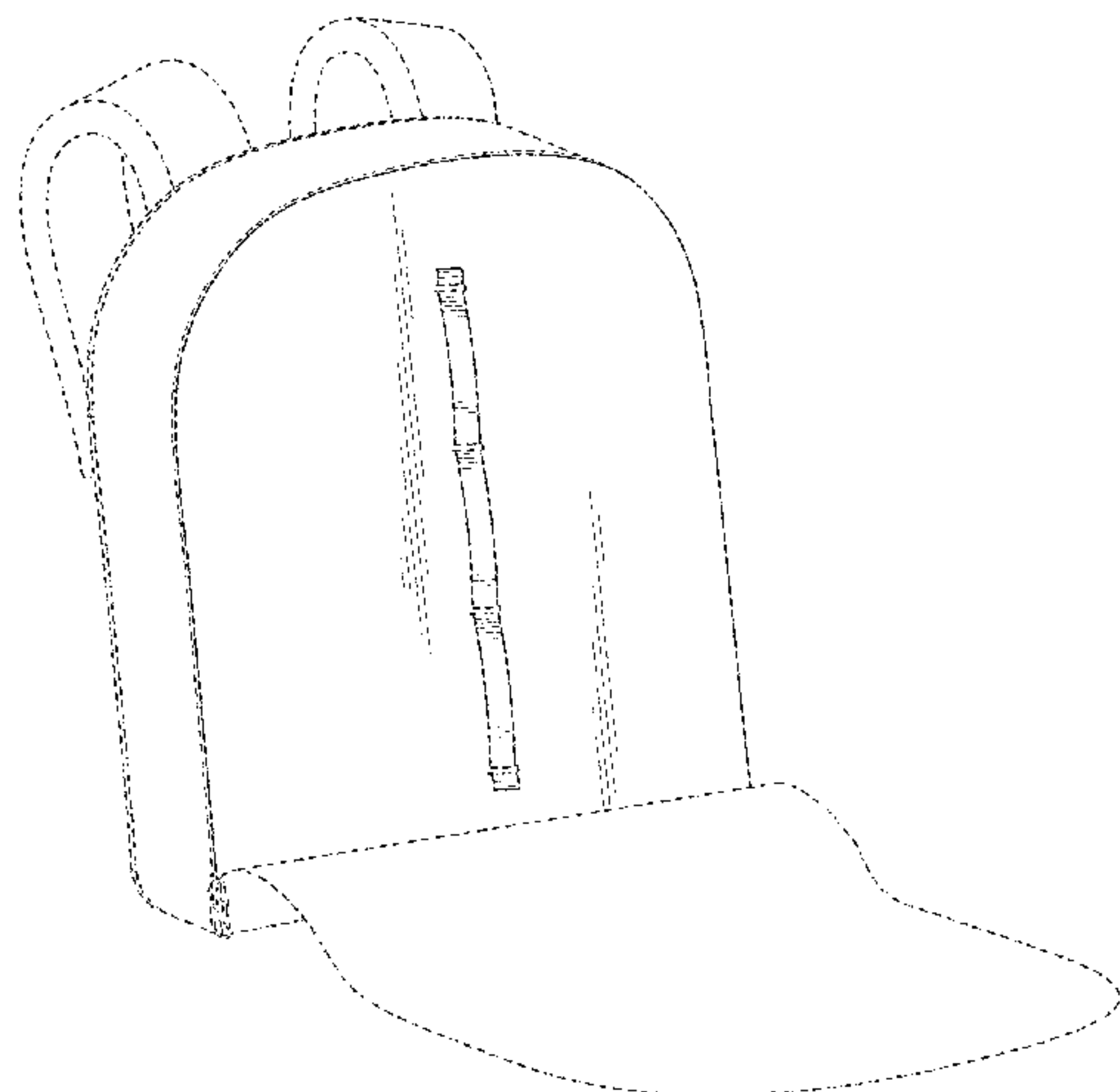

FIG. 37 is a rear plan view thereof;
 FIG. 38 is a front plan view thereof;
 FIG. 39 is a right-side view thereof;
 FIG. 40 is a left-side view thereof;
 FIG. 41 is a top view thereof;
 FIG. 42 is a bottom view thereof;
 FIG. 43 is a perspective view of a seventh embodiment of a backpack with an insert arrangement showing my new ornamental design;
 FIG. 44 is a rear plan view thereof;
 FIG. 45 is a front plan view thereof;
 FIG. 46 is a right-side view thereof;
 FIG. 47 is a left-side view thereof;
 FIG. 48 is a top view thereof;
 FIG. 49 is a bottom view thereof;
 FIG. 50 is a perspective view of an eighth embodiment of a backpack with an insert arrangement showing my new ornamental design;
 FIG. 51 is a rear plan view thereof;
 FIG. 52 is a front plan view thereof;
 FIG. 53 is a right-side view thereof;
 FIG. 54 is a left-side view thereof;
 FIG. 55 is a top view thereof;
 FIG. 56 is a bottom view thereof;
 FIG. 57 is a perspective view of a ninth embodiment of a backpack with an insert arrangement showing my new ornamental design;
 FIG. 58 is a rear plan view thereof;
 FIG. 59 is a front plan view thereof;
 FIG. 60 is a right-side view thereof;
 FIG. 61 is a left-side view thereof;
 FIG. 62 is a top view thereof;
 FIG. 63 is a bottom view thereof;
 FIG. 64 is a perspective view of a tenth embodiment of a backpack with an insert arrangement showing my new ornamental design;
 FIG. 65 is a rear plan view thereof;
 FIG. 66 is a front plan view thereof;
 FIG. 67 is a right-side view thereof;
 FIG. 68 is a left-side view thereof;
 FIG. 69 is a top view thereof;
 FIG. 70 is a bottom view thereof;
 FIG. 71 is a perspective view of an eleventh embodiment of a backpack with an insert arrangement showing my new ornamental design;

FIG. 72 is a rear plan view thereof;
 FIG. 73 is a front plan view thereof;
 FIG. 74 is a right-side view thereof;
 FIG. 75 is a left-side view thereof;
 FIG. 76 is a top view thereof;
 FIG. 77 is a bottom view thereof;
 FIG. 78 is a perspective view of a twelfth embodiment of a backpack with an insert arrangement showing my new ornamental design;
 FIG. 79 is a rear plan view thereof;
 FIG. 80 is a front plan view thereof;
 FIG. 81 is a right-side view thereof;
 FIG. 82 is a left-side view thereof;
 FIG. 83 is a top view thereof; and,
 FIG. 84 is a bottom view thereof.

The broken lines are included to illustrate environmental structure and form no part of the claimed design.

My design is not limited to the exact details shown in the drawings, since equivalents and colorable imitations thereof will be evident to a person of ordinary skill in the art. Within the scope of the appended claim, in which I intend to cover only the ornamental and novel elements shown in the drawings, my invention may be practiced otherwise than as specifically shown and described herein.

1 Claim, 84 Drawing Sheets

(58) **Field of Classification Search**

CPC A45F 4/02; A45F 3/04; A45C 5/03; A45C
 2005/032

See application file for complete search history.

(56) **References Cited**

U.S. PATENT DOCUMENTS

D702,944	S	*	4/2014	Sanchez	D3/319
D799,214	S	*	10/2017	Chalk	D3/318
D844,976	S	*	4/2019	Munie	D3/217
D850,109	S	*	6/2019	Rachlin	D3/319
D858,093	S	*	9/2019	Cunha	D3/233

* cited by examiner

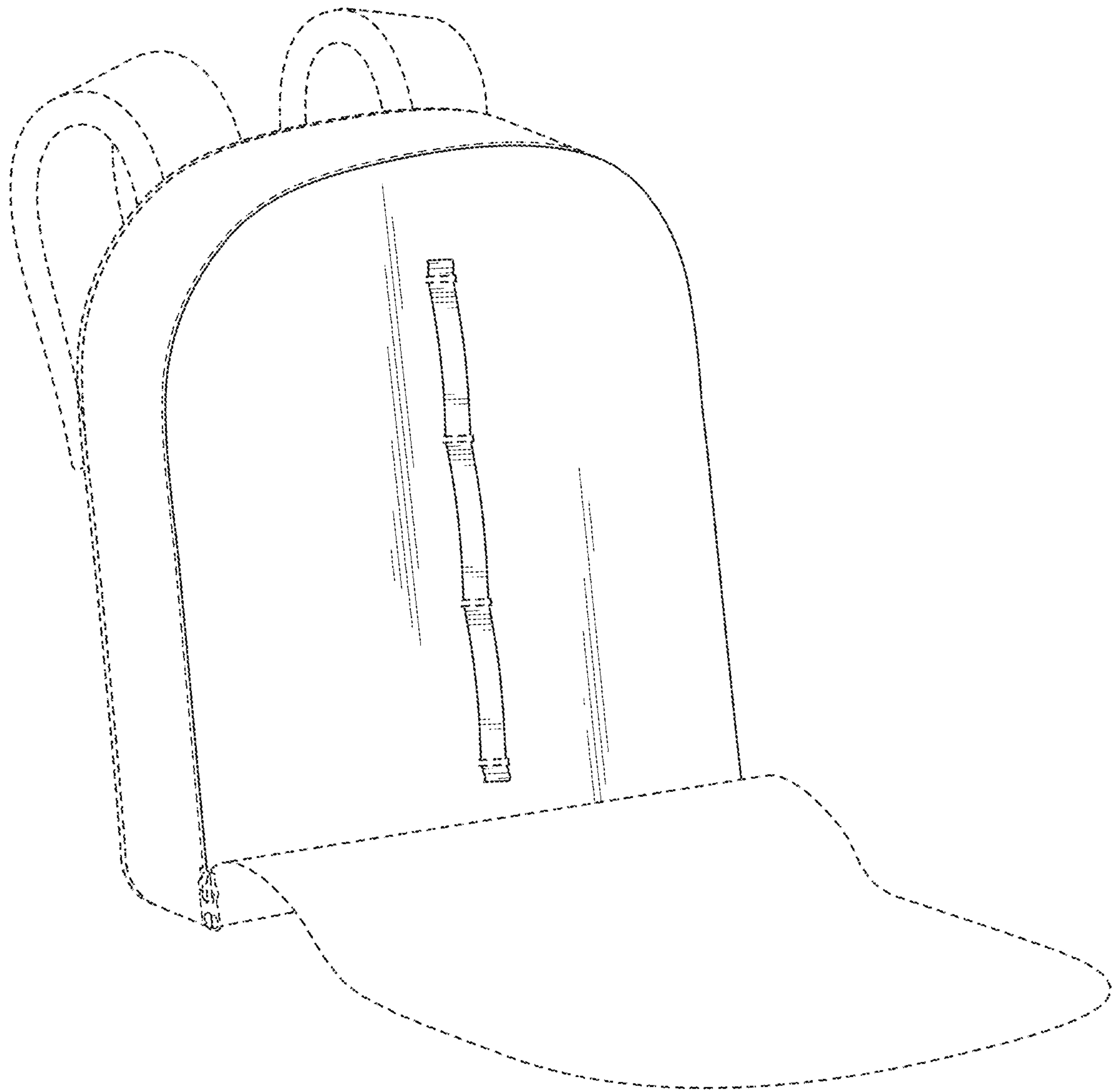

Fig. 1

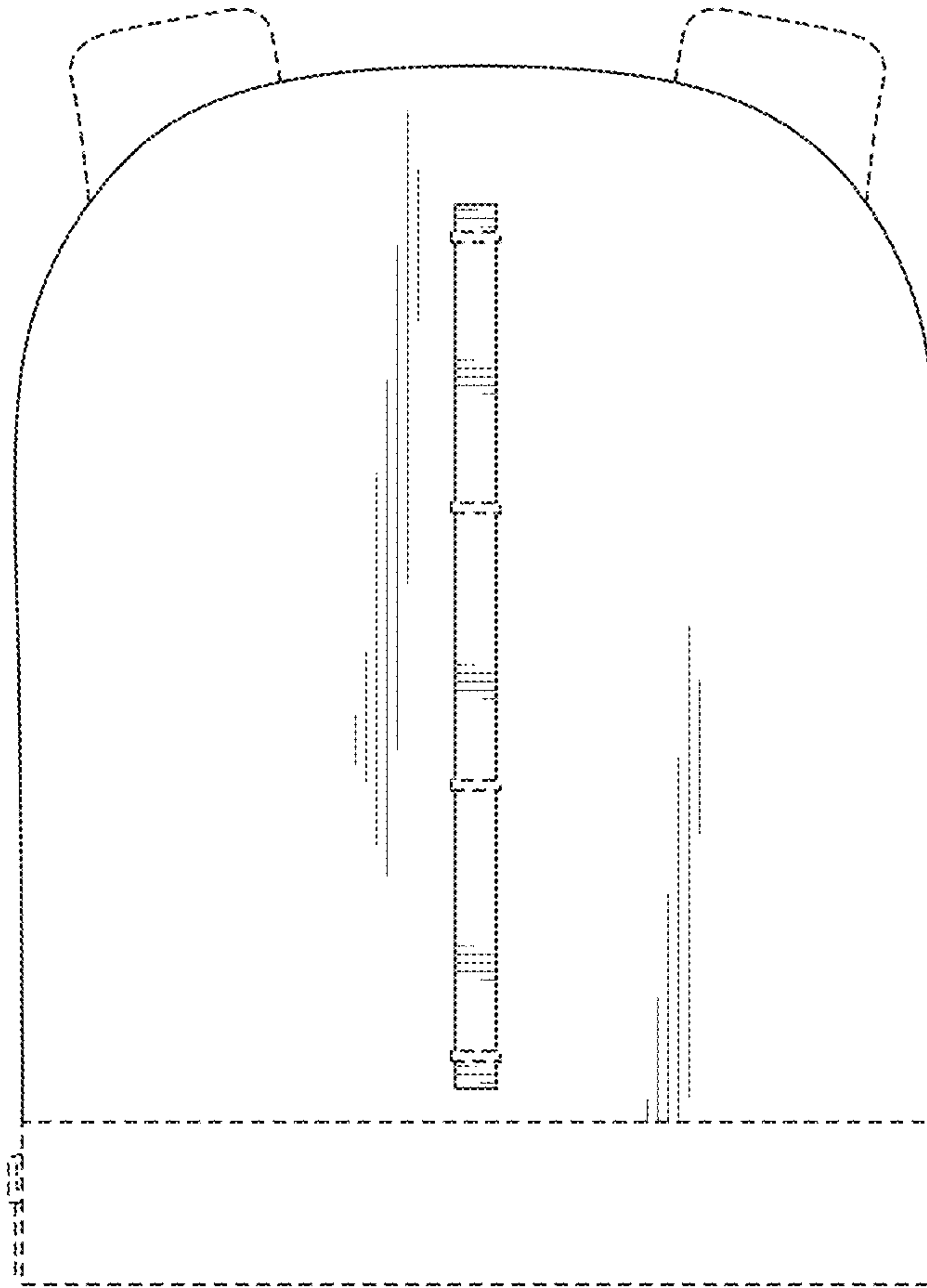

Fig. 2

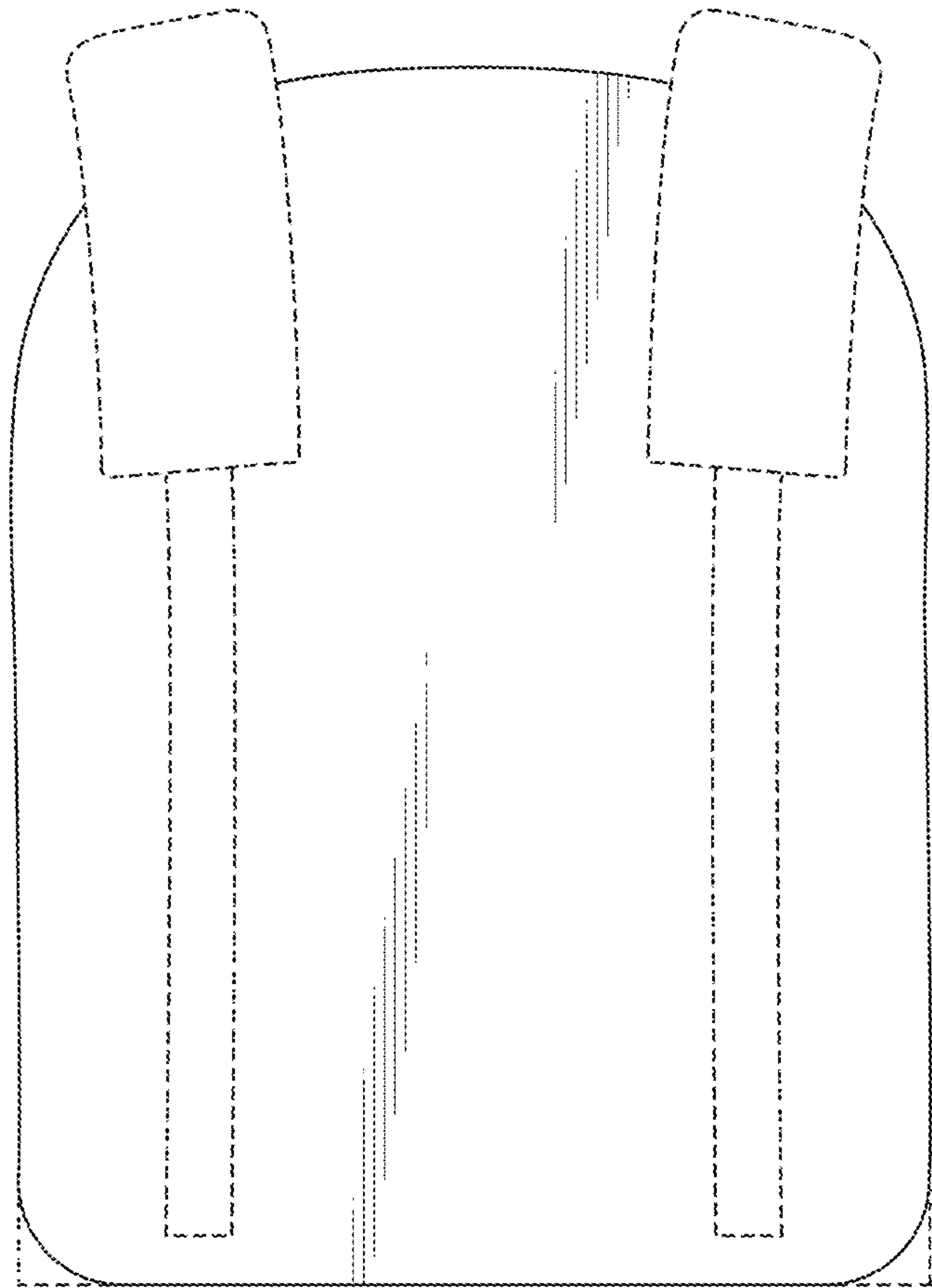

Fig. 3

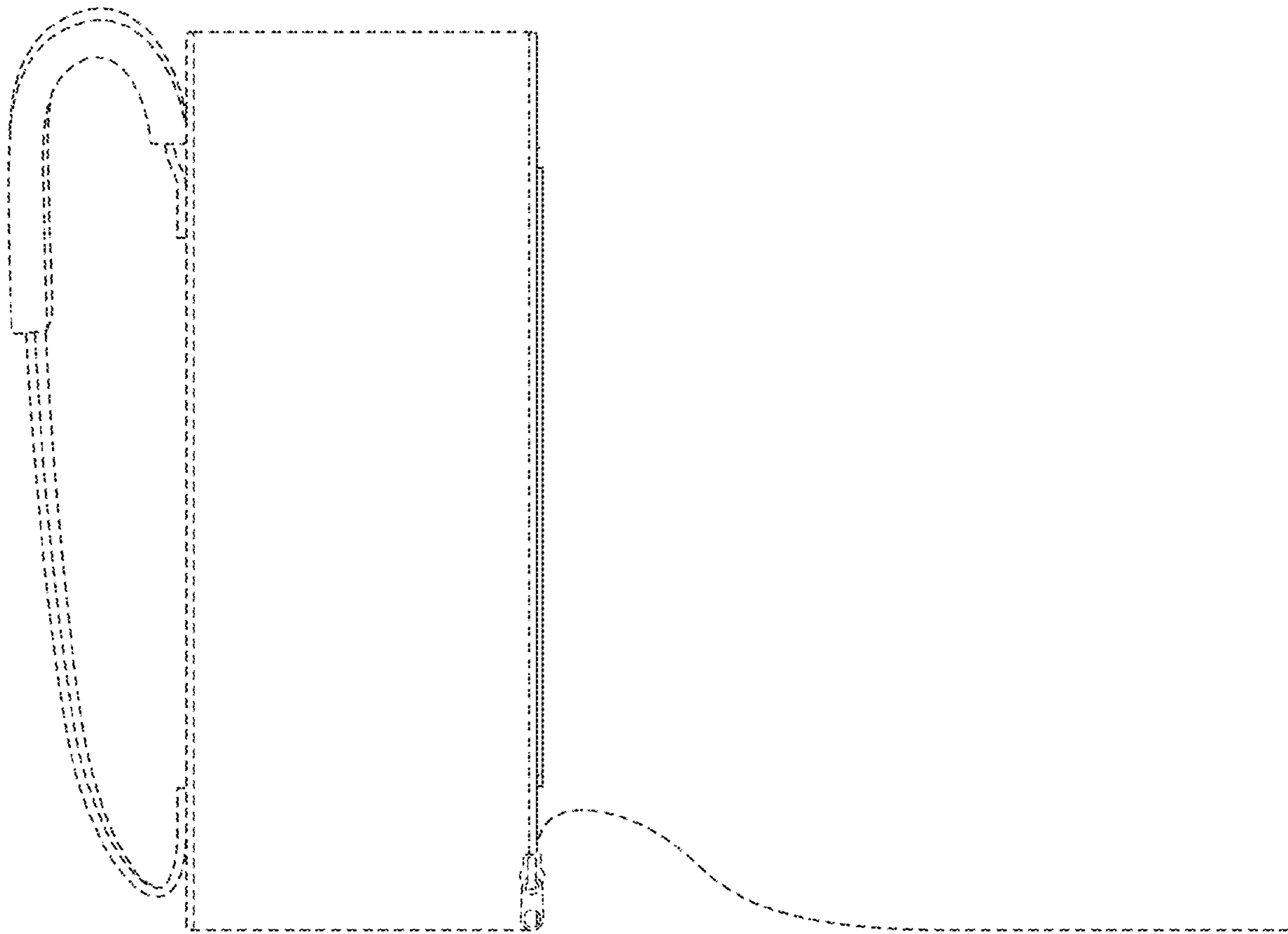

Fig. 4

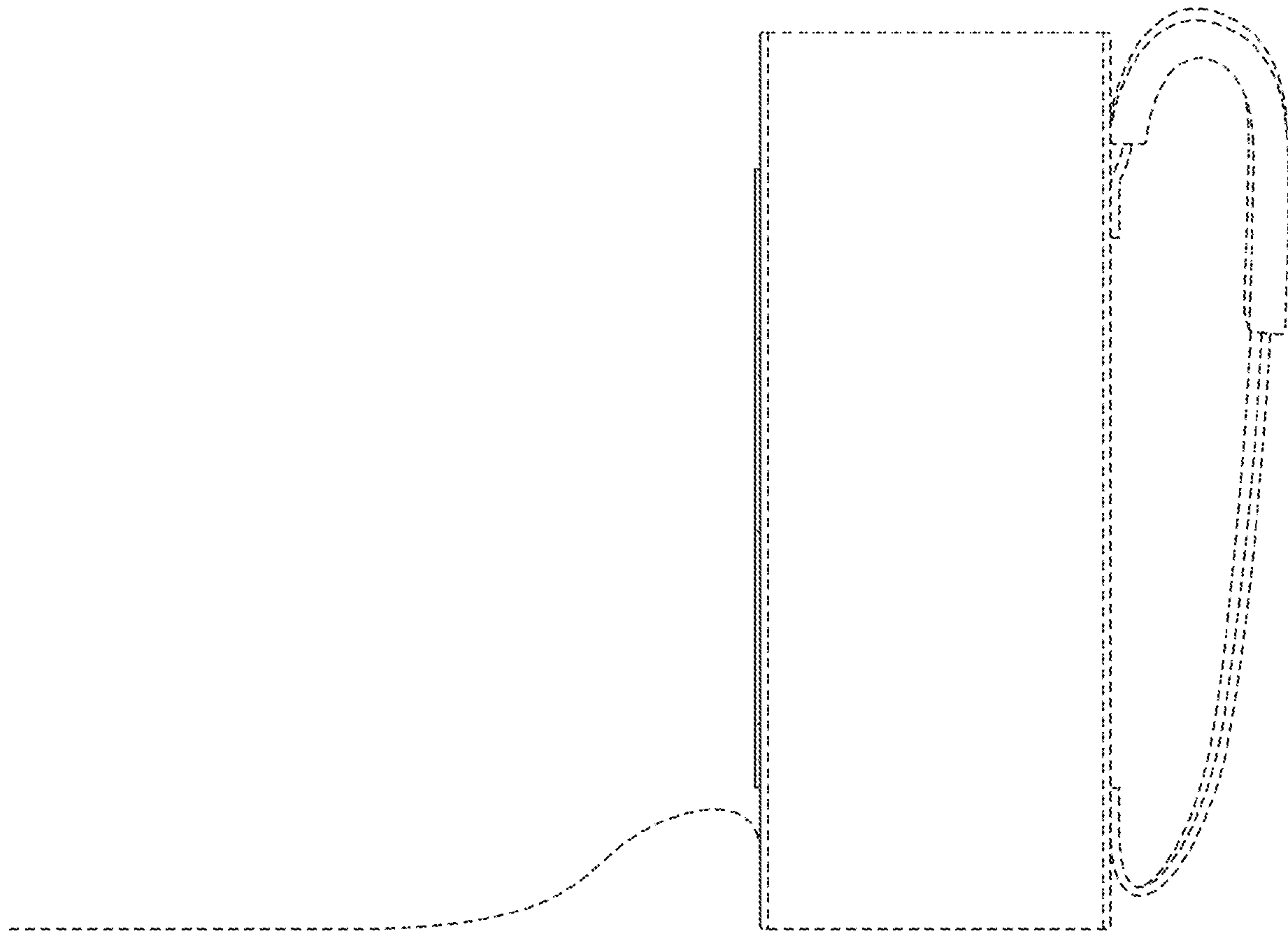

Fig. 5

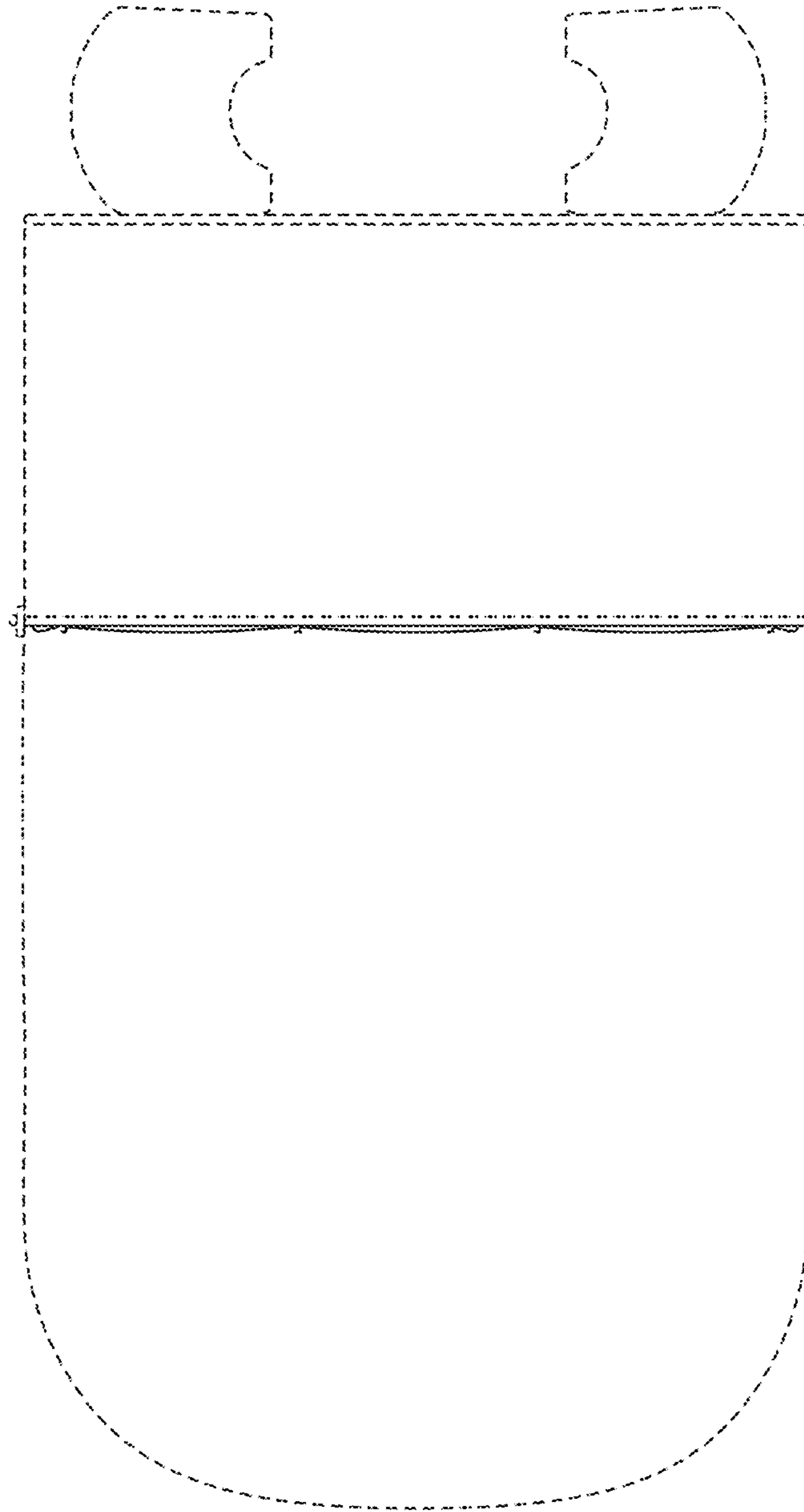

Fig. 6

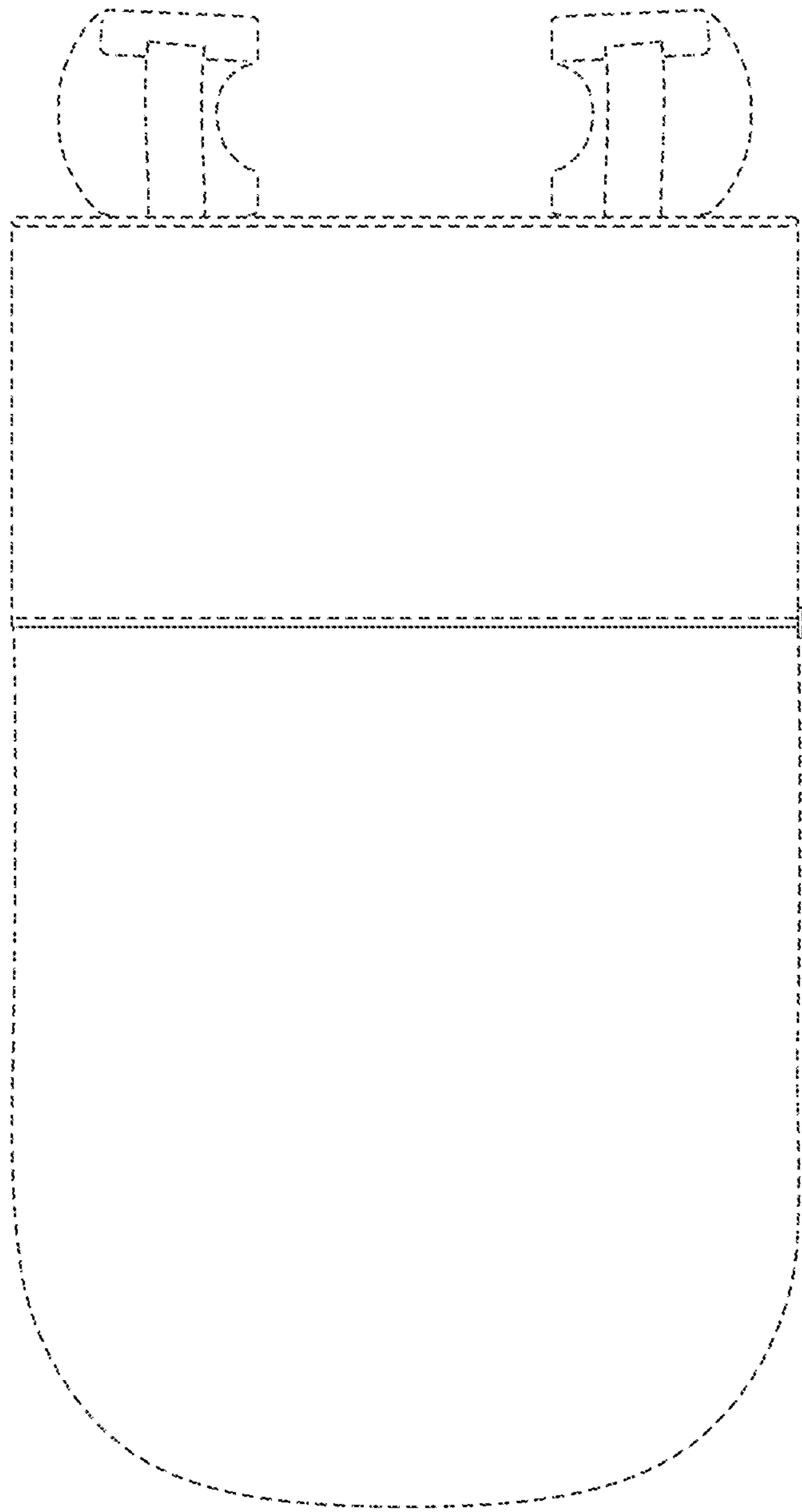

Fig. 7

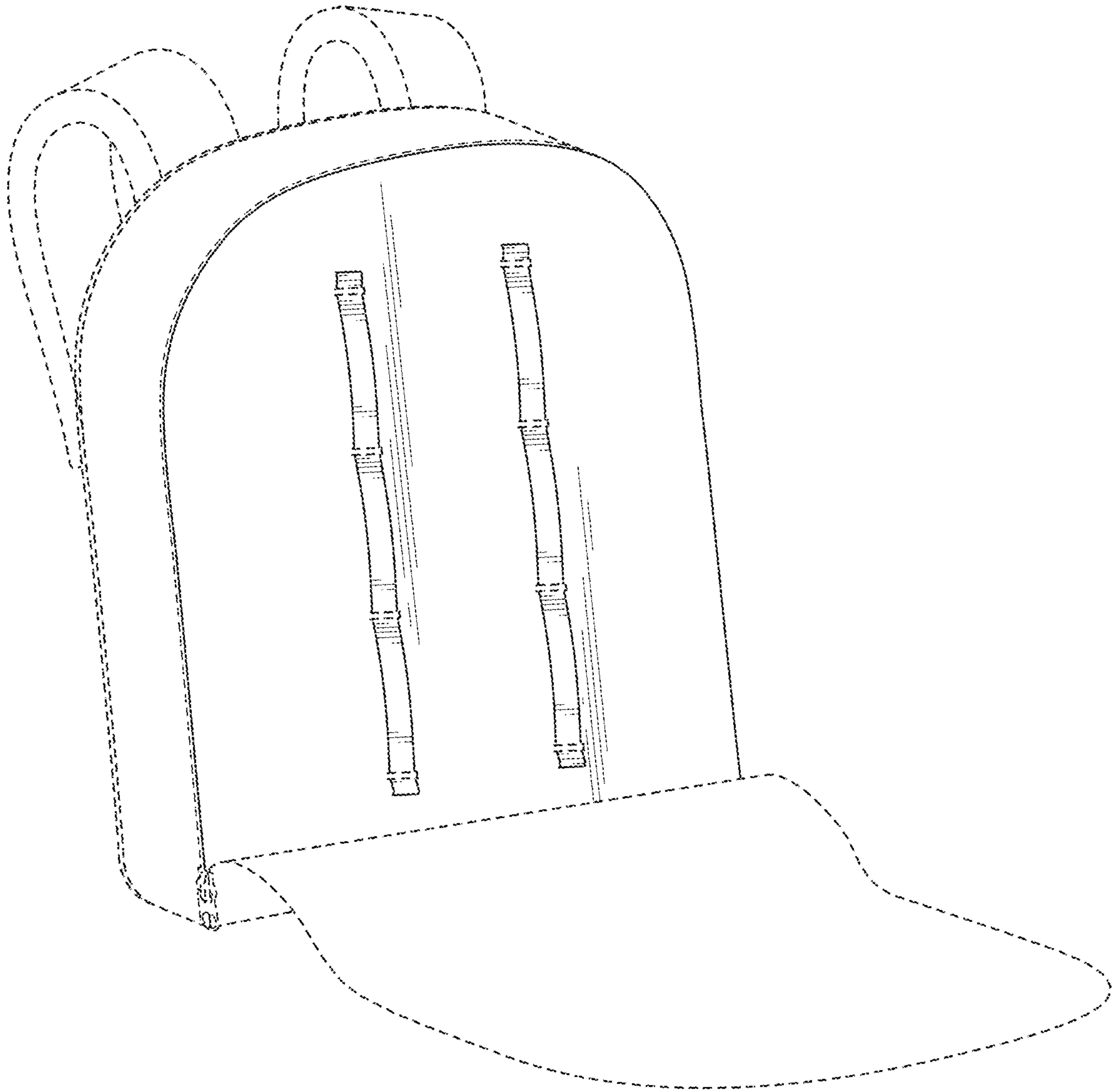

Fig. 8

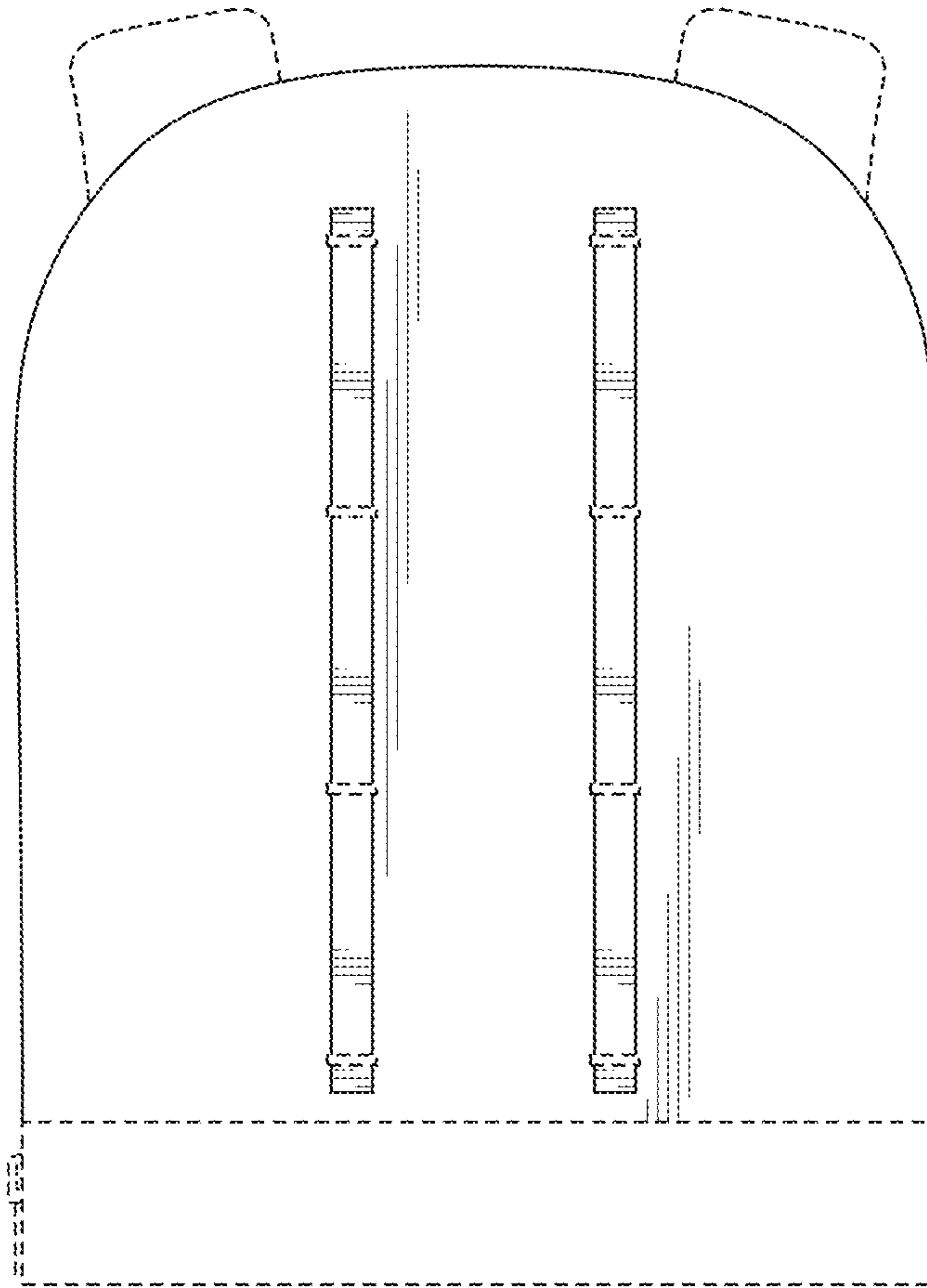

Fig. 9

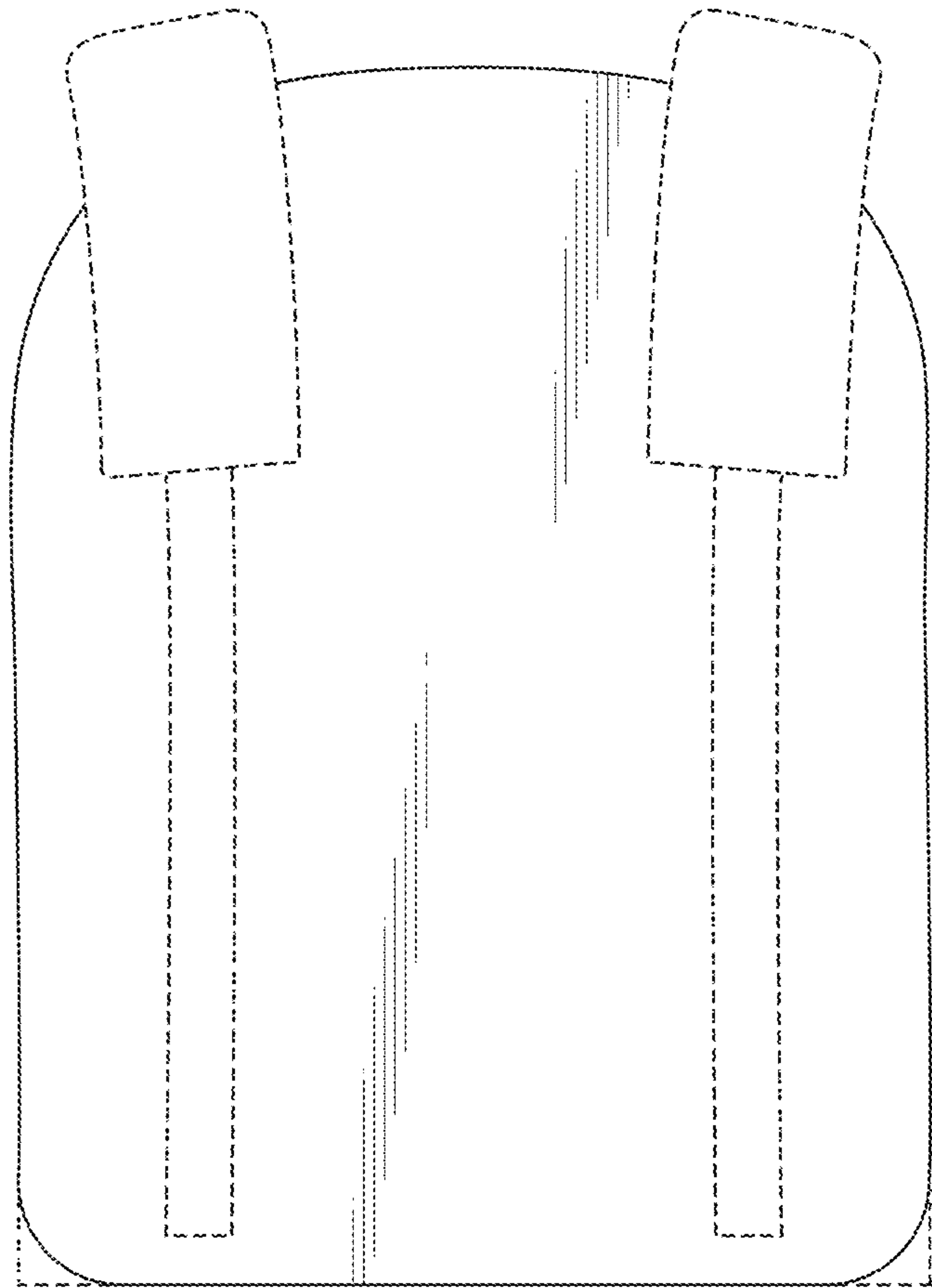

Fig. 10

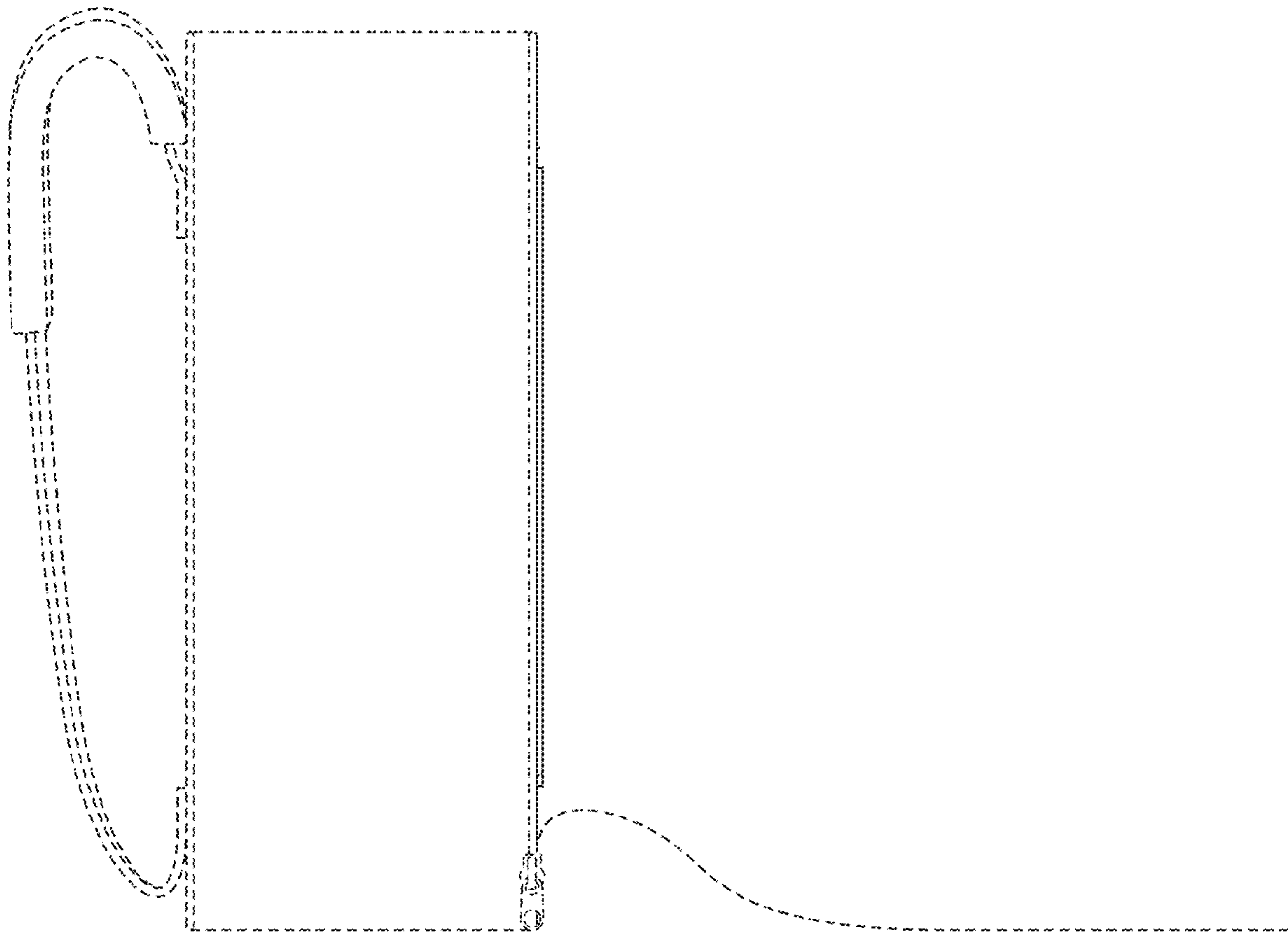

Fig. 11

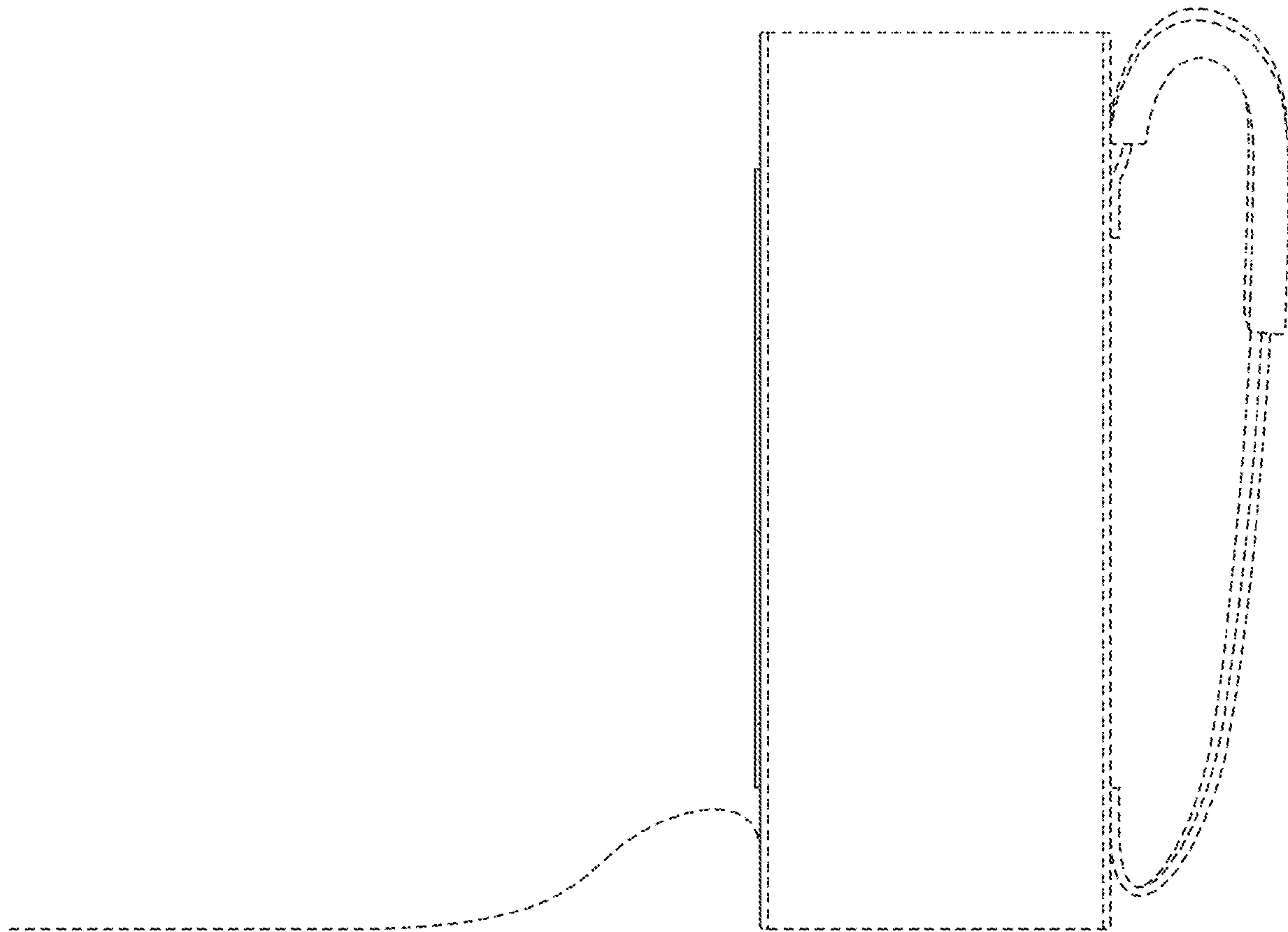

Fig. 12

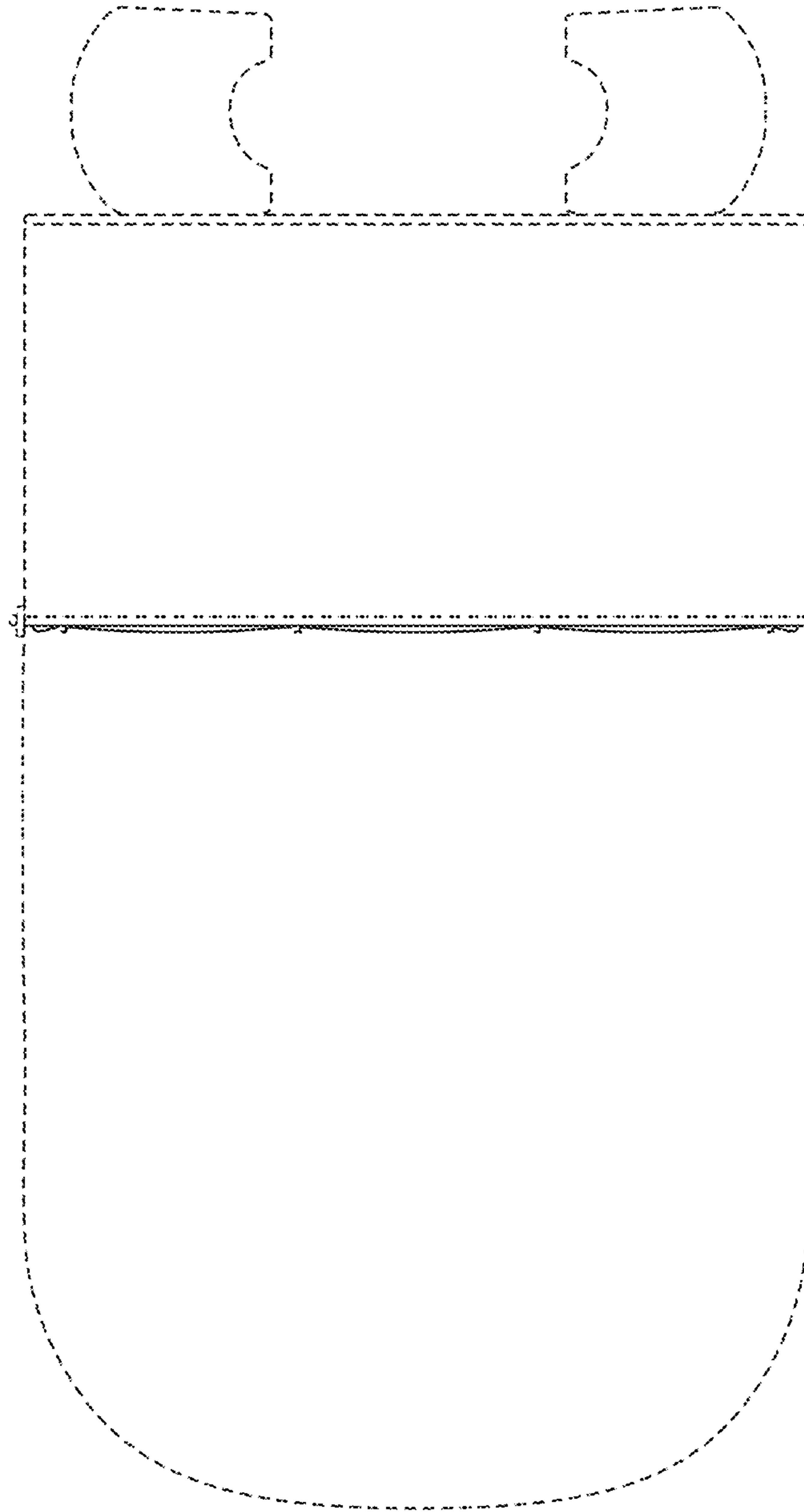

Fig. 13

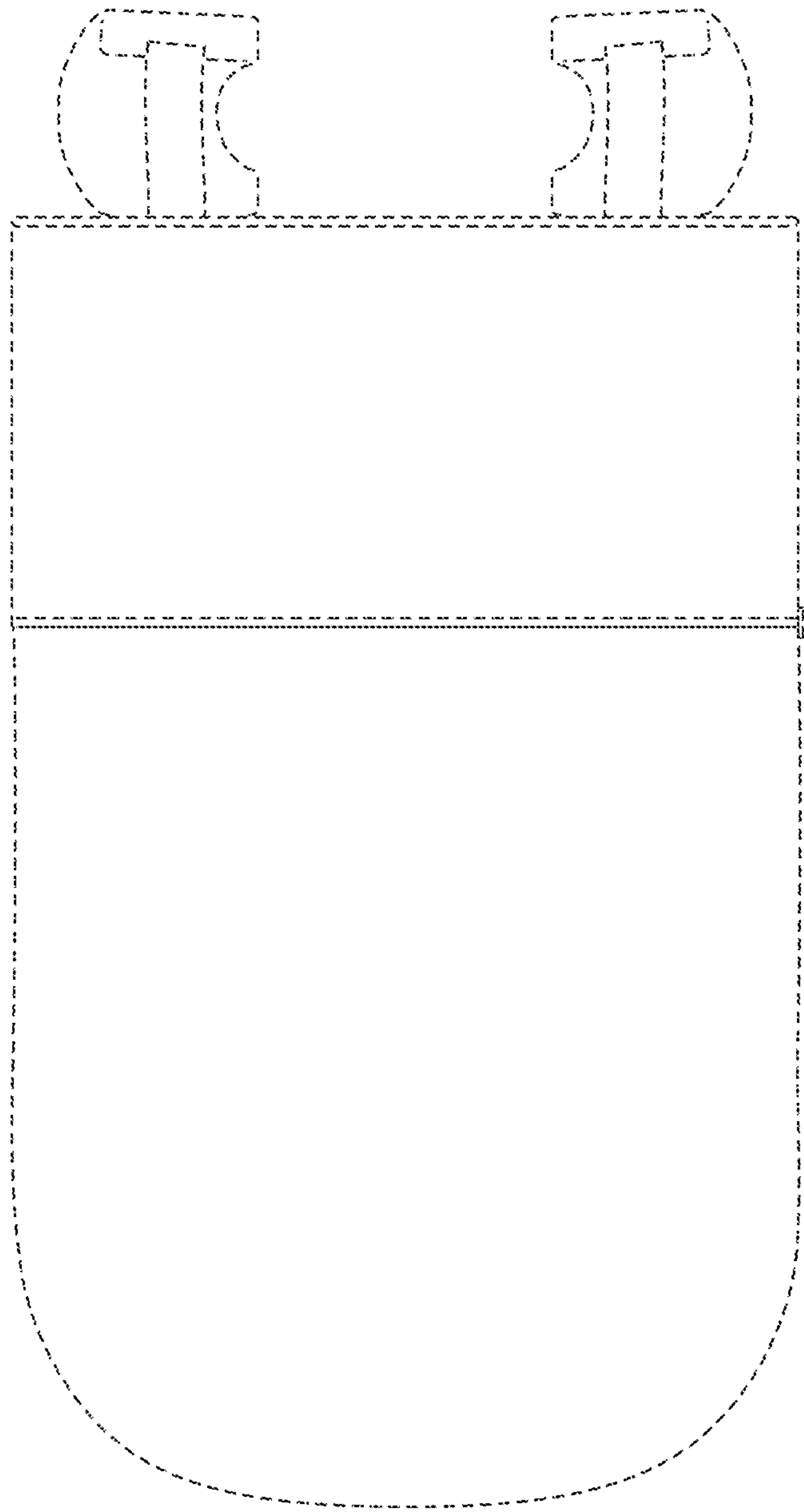

Fig. 14

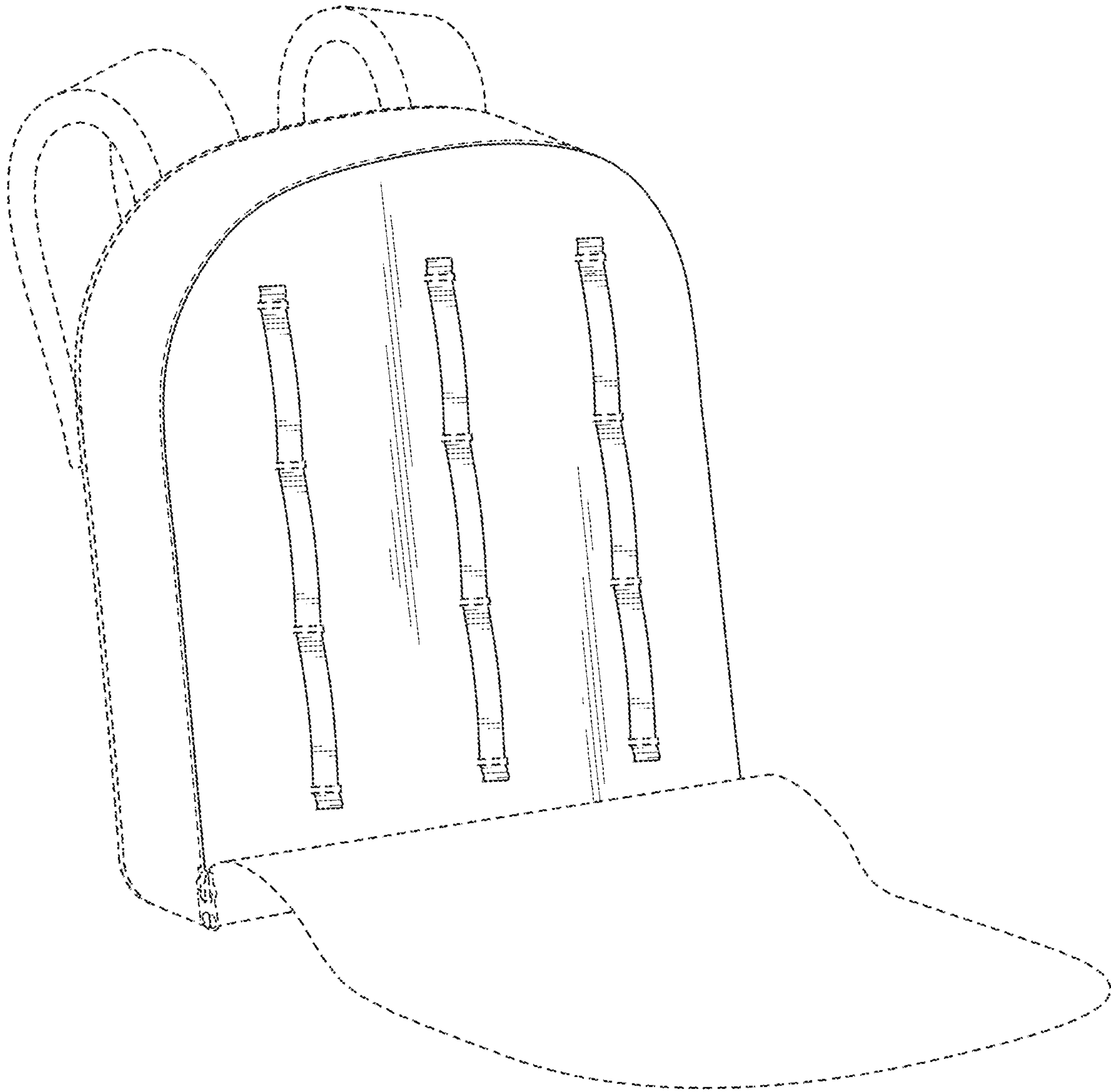

Fig. 15

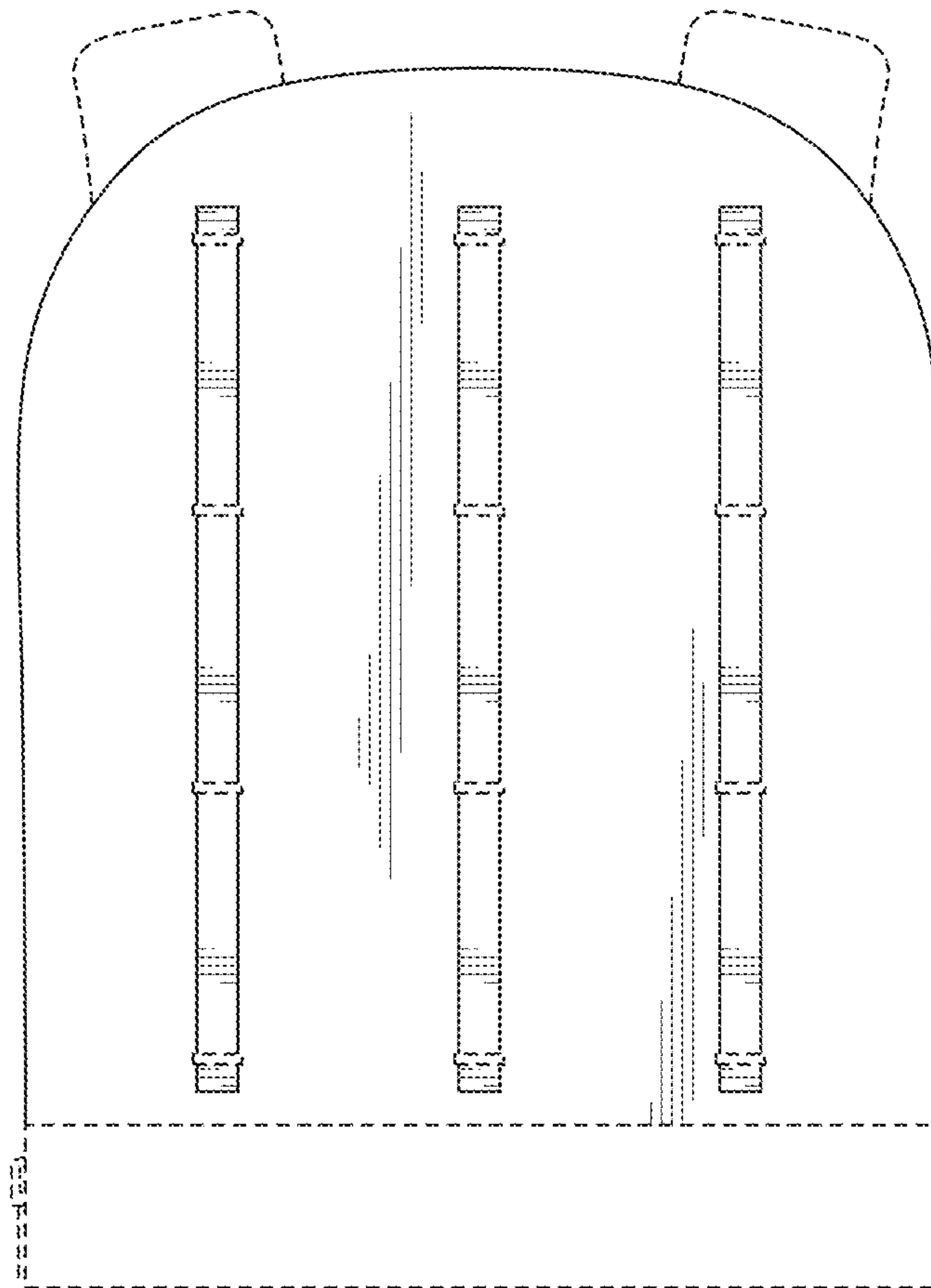

Fig. 16

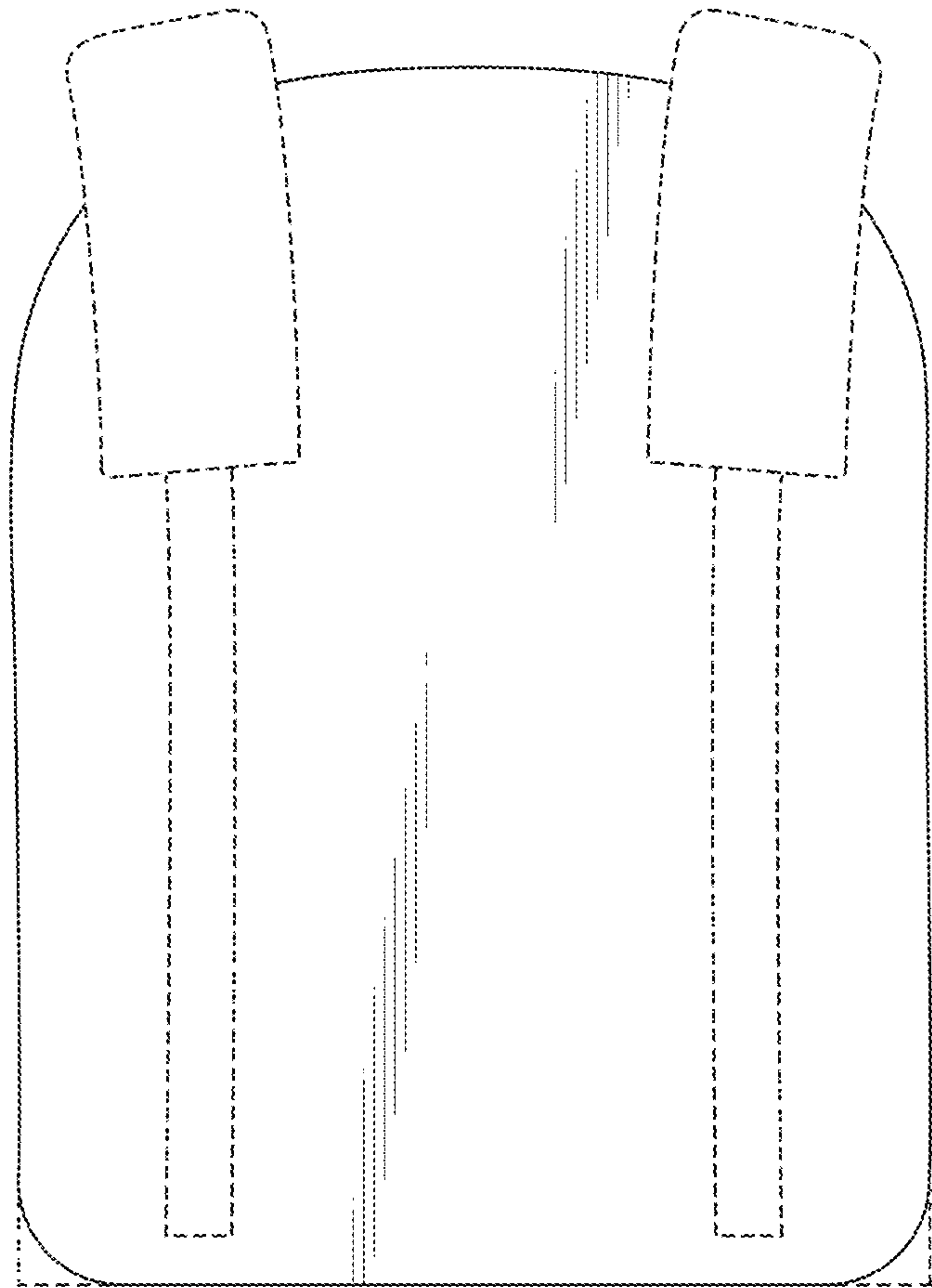

Fig. 17

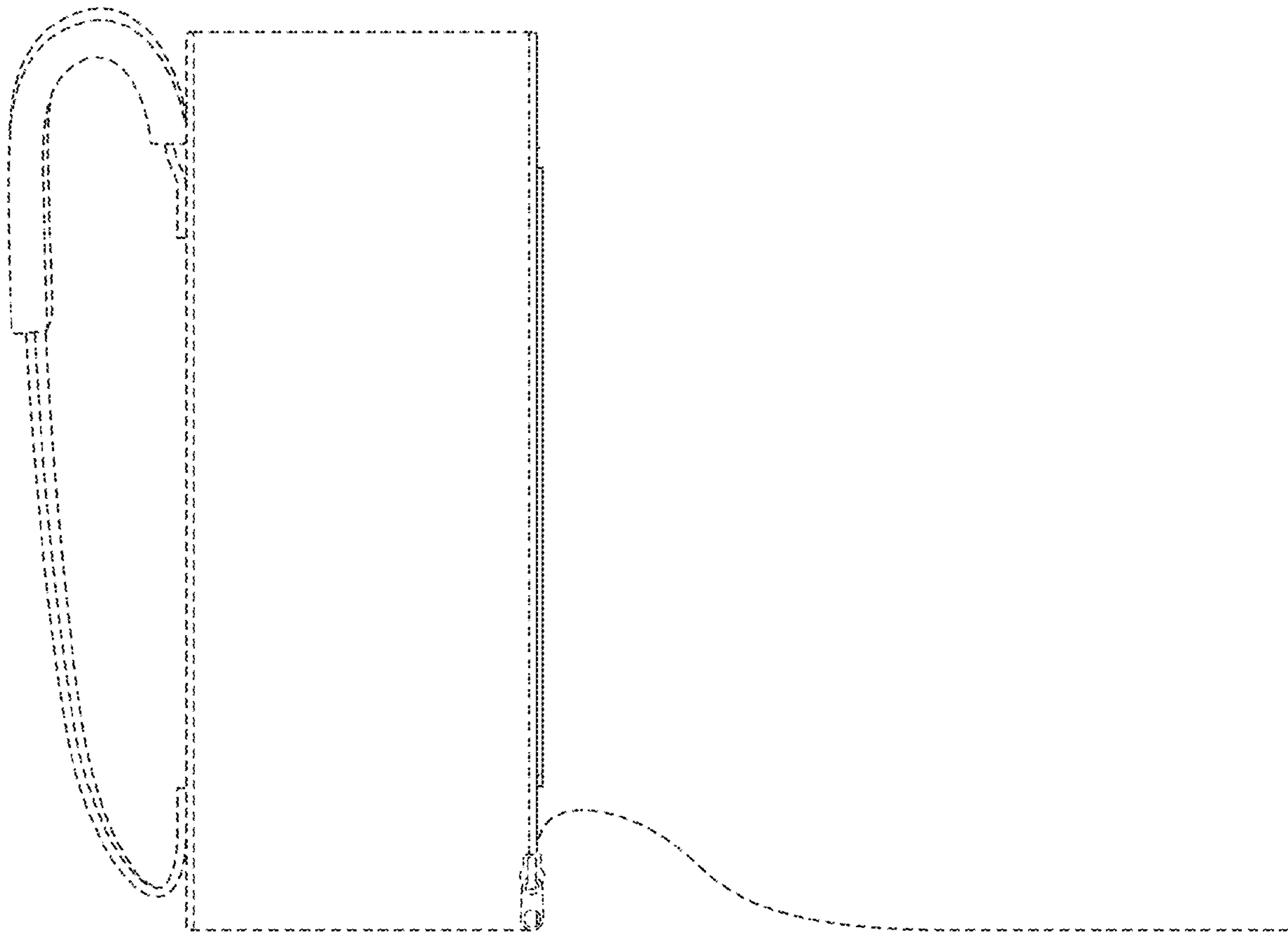

Fig. 18

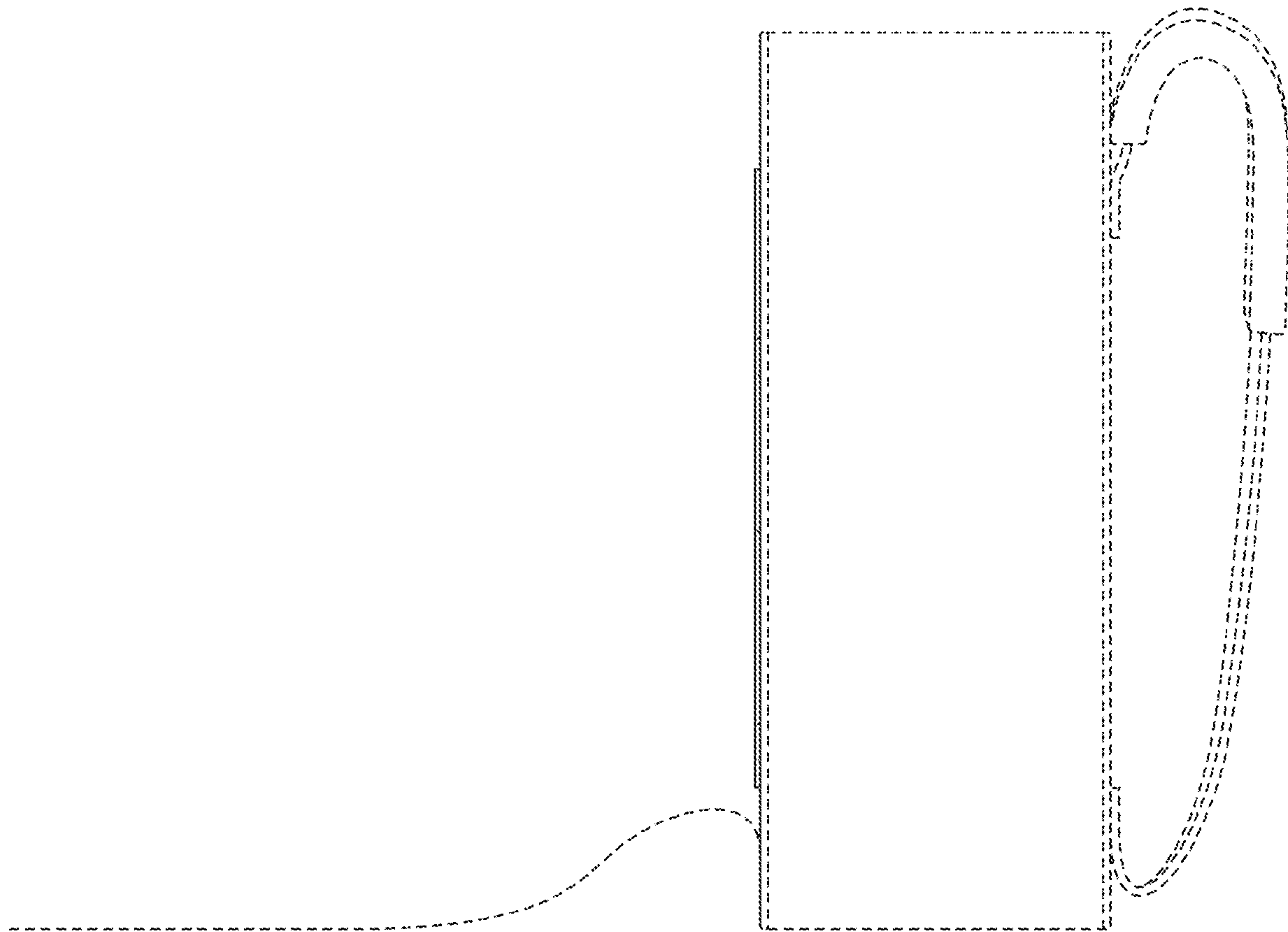

Fig. 19

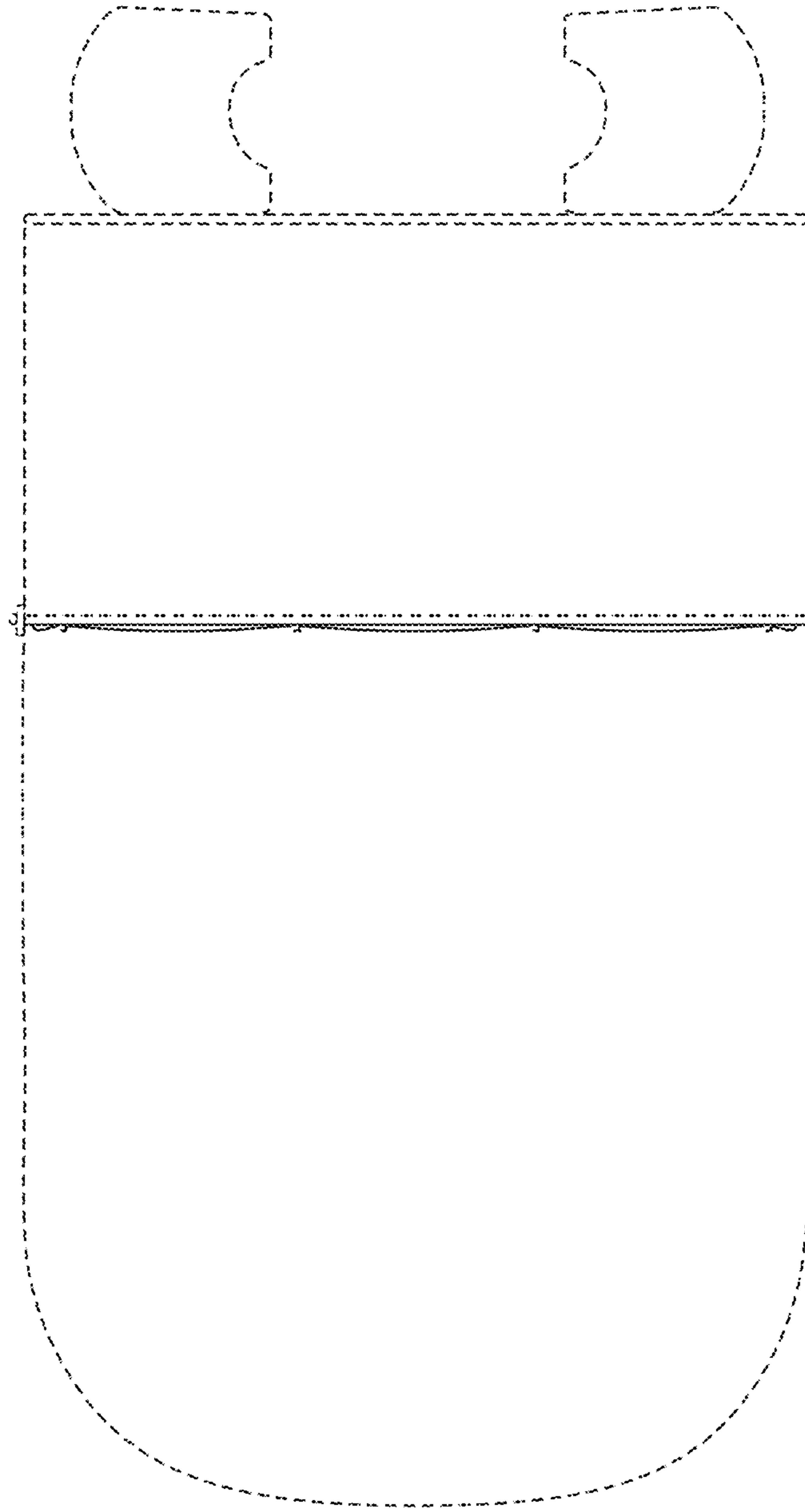

Fig. 20

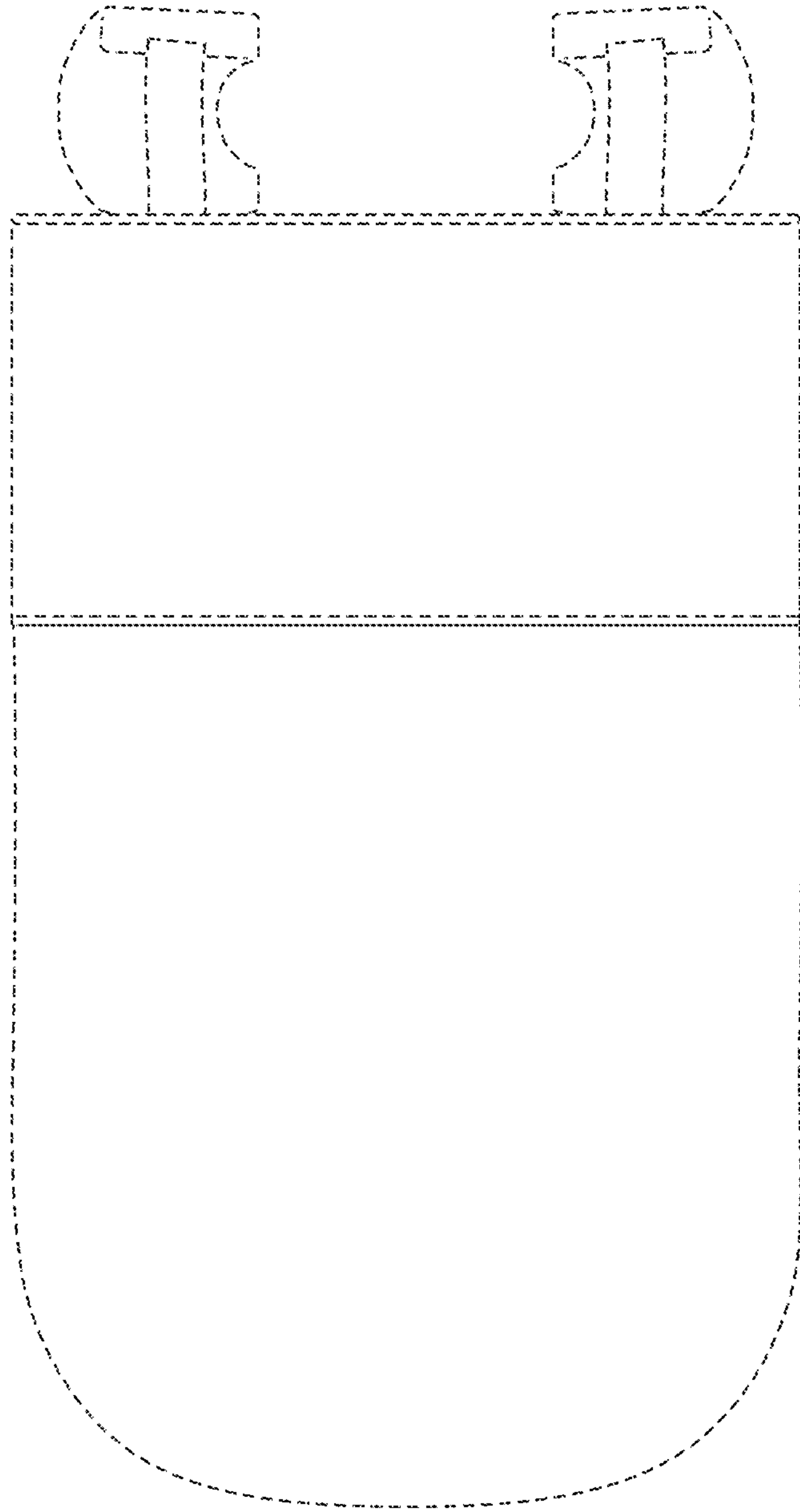

Fig. 21

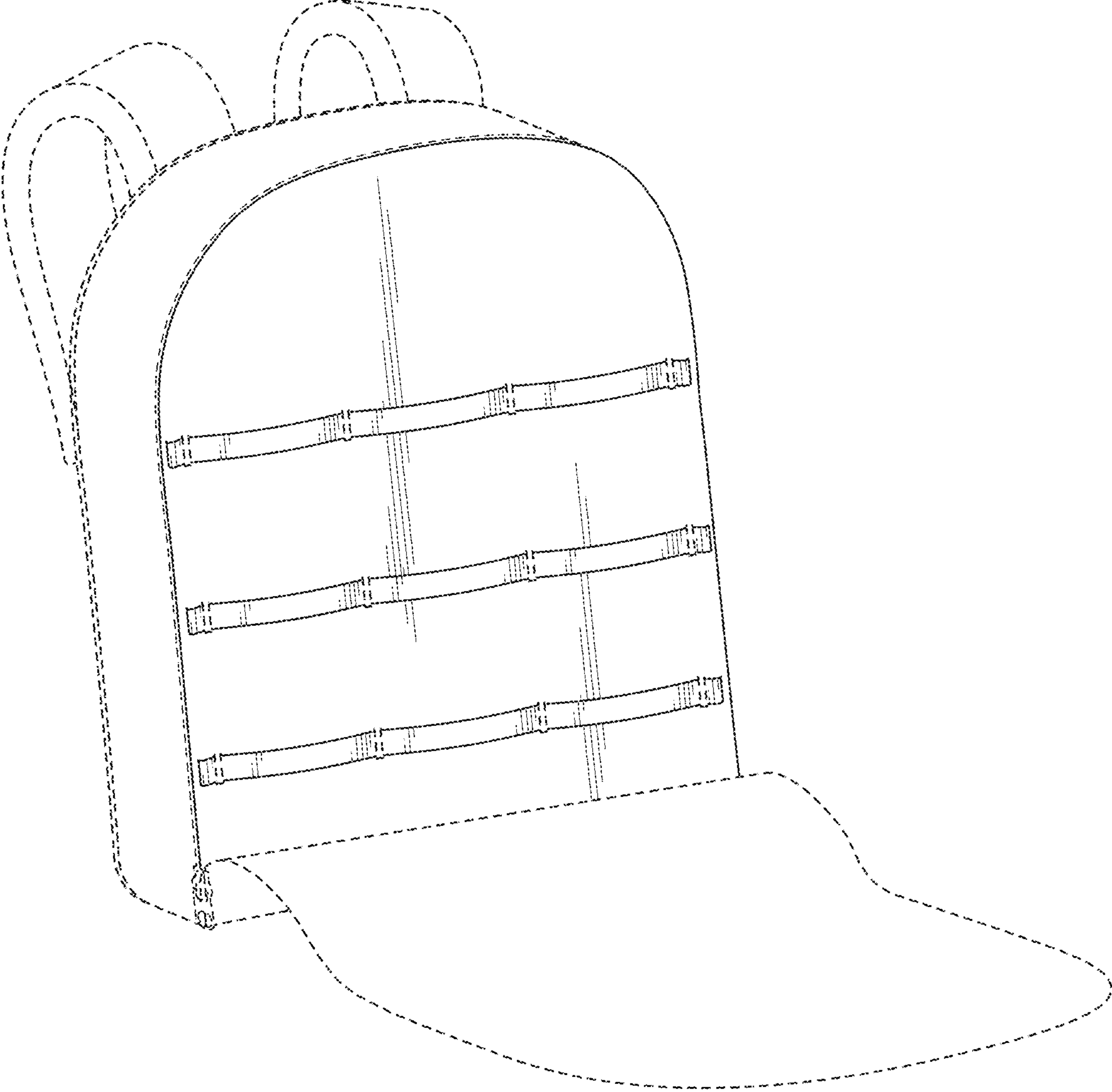

Fig. 22

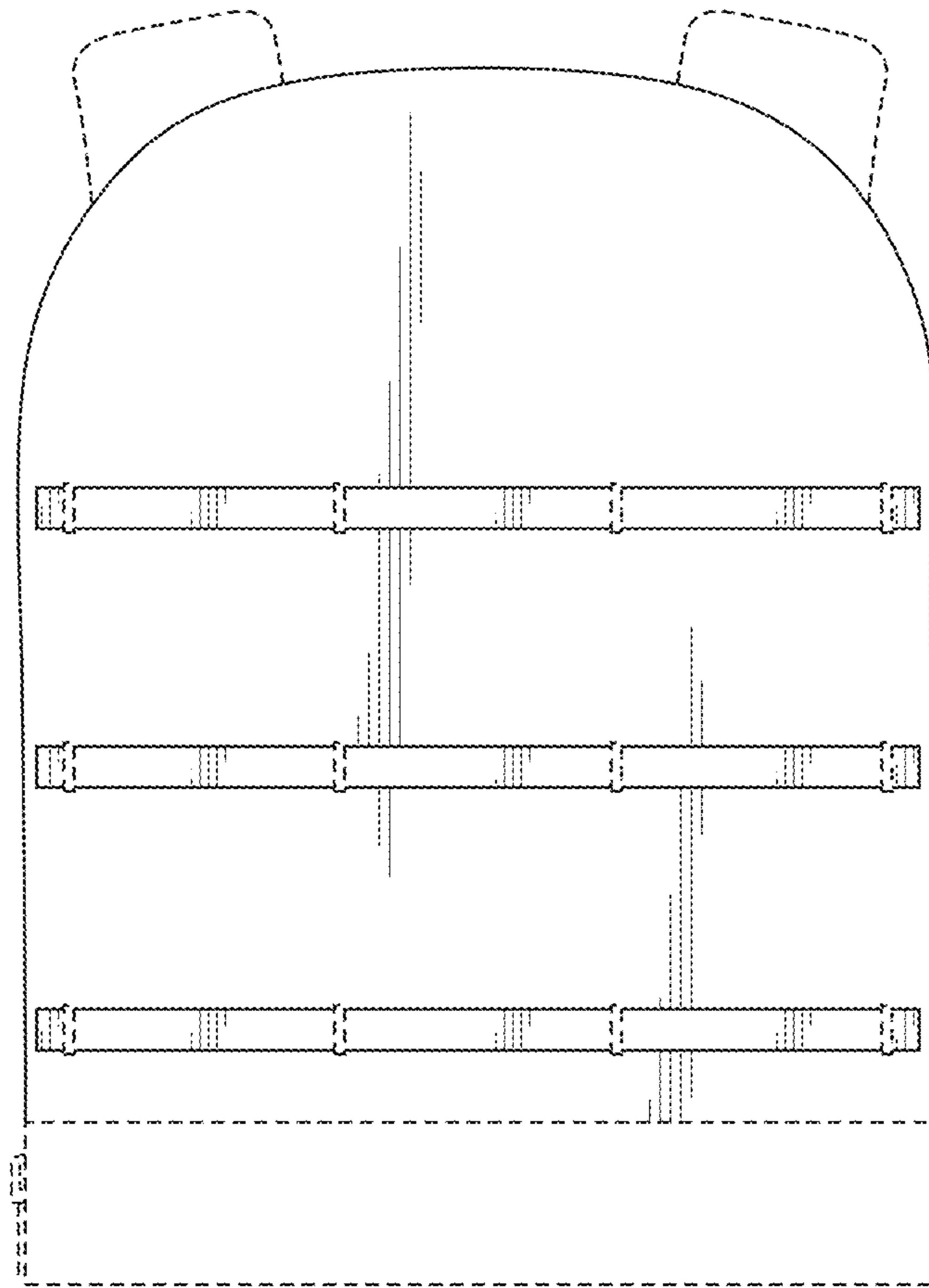

Fig. 23

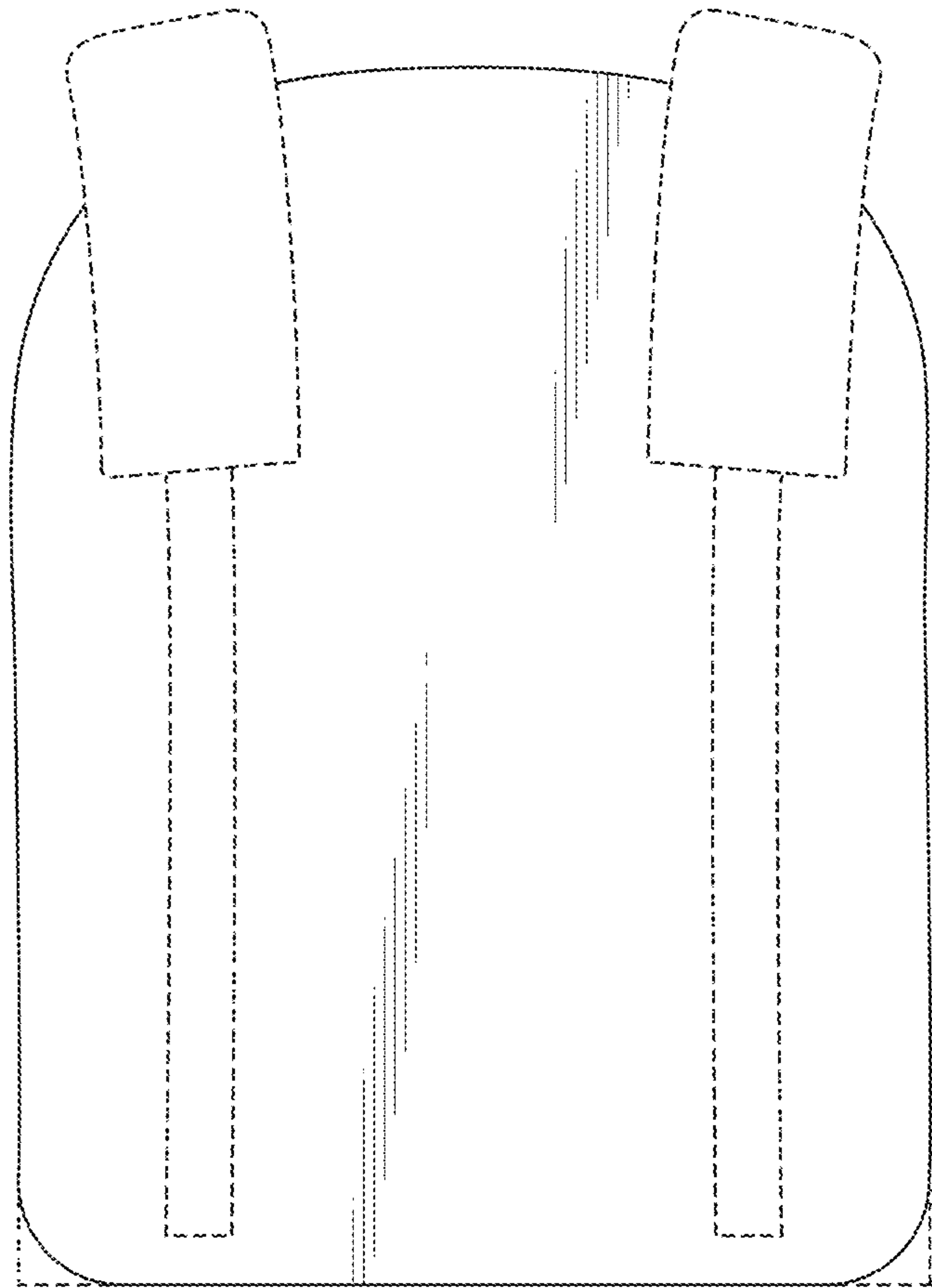

Fig. 24

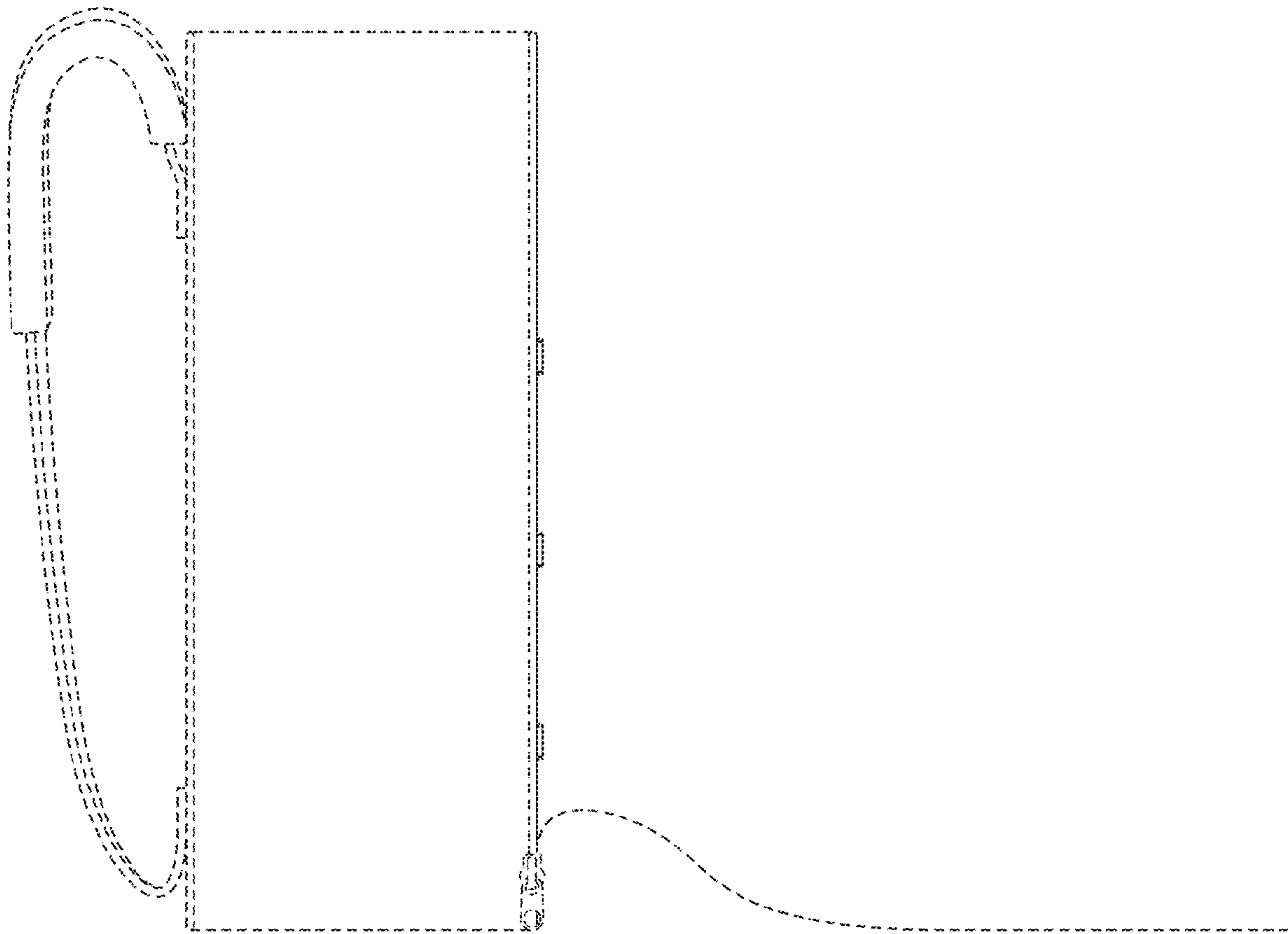

Fig. 25

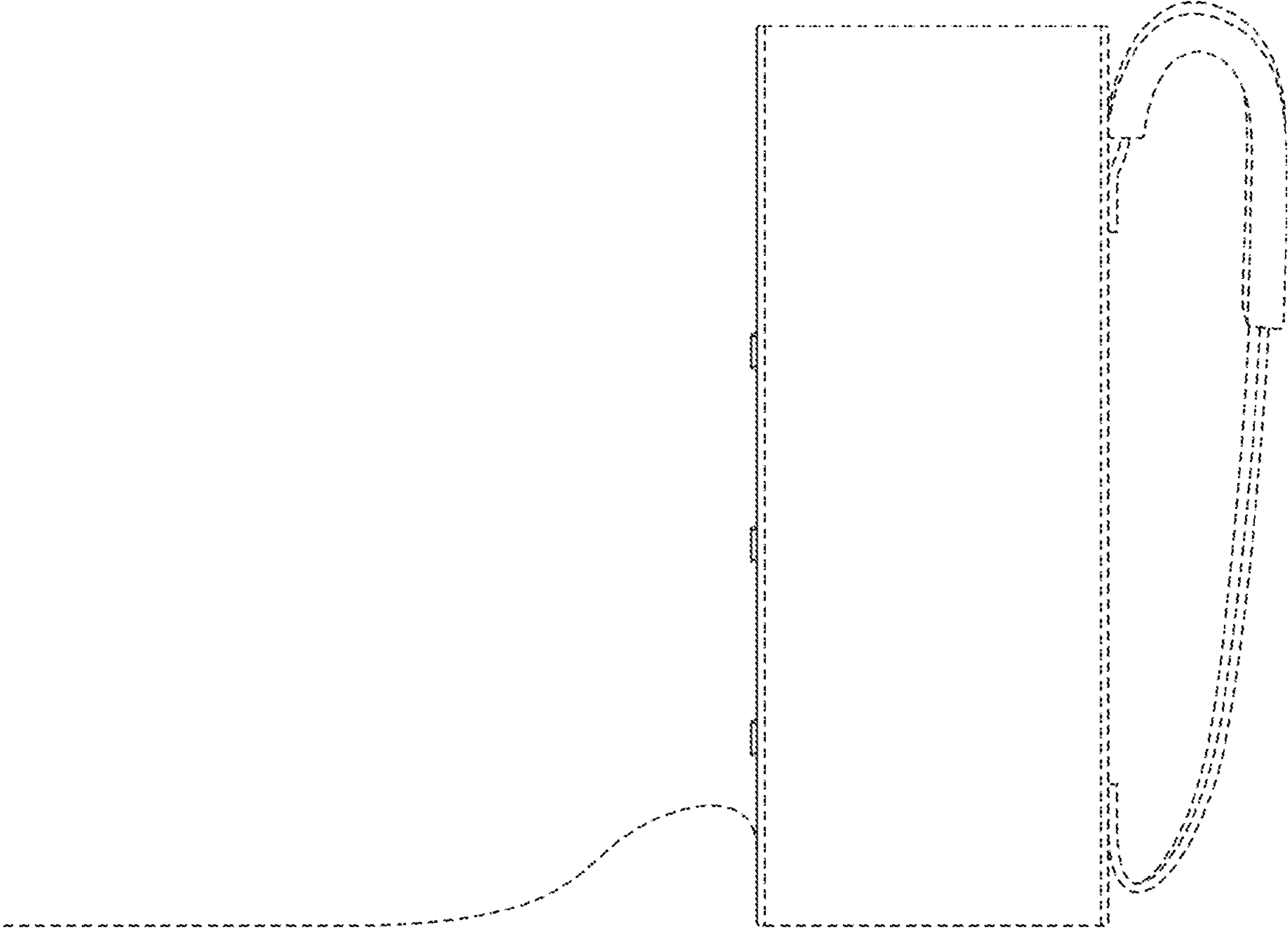

Fig. 26

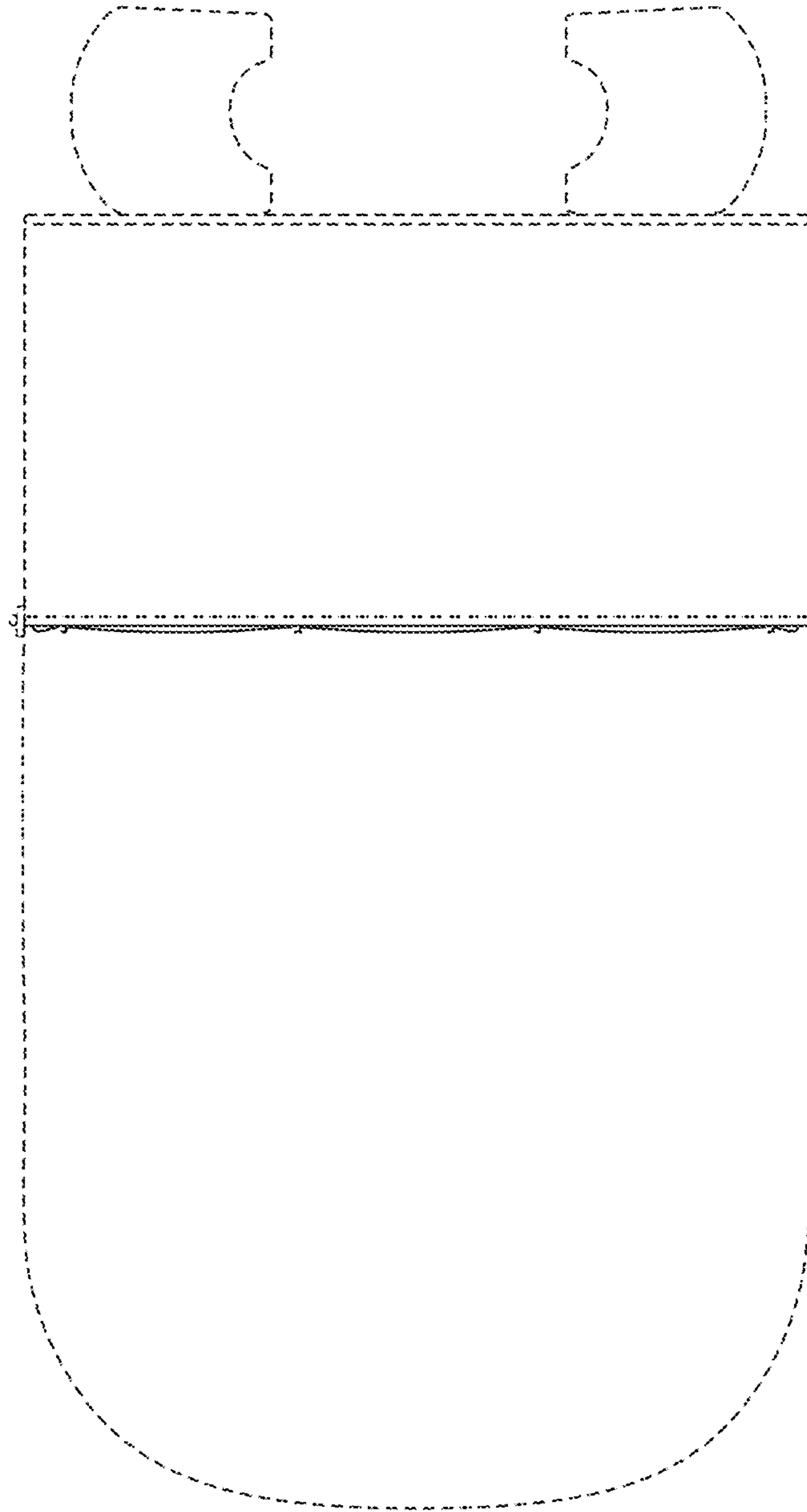

Fig. 27

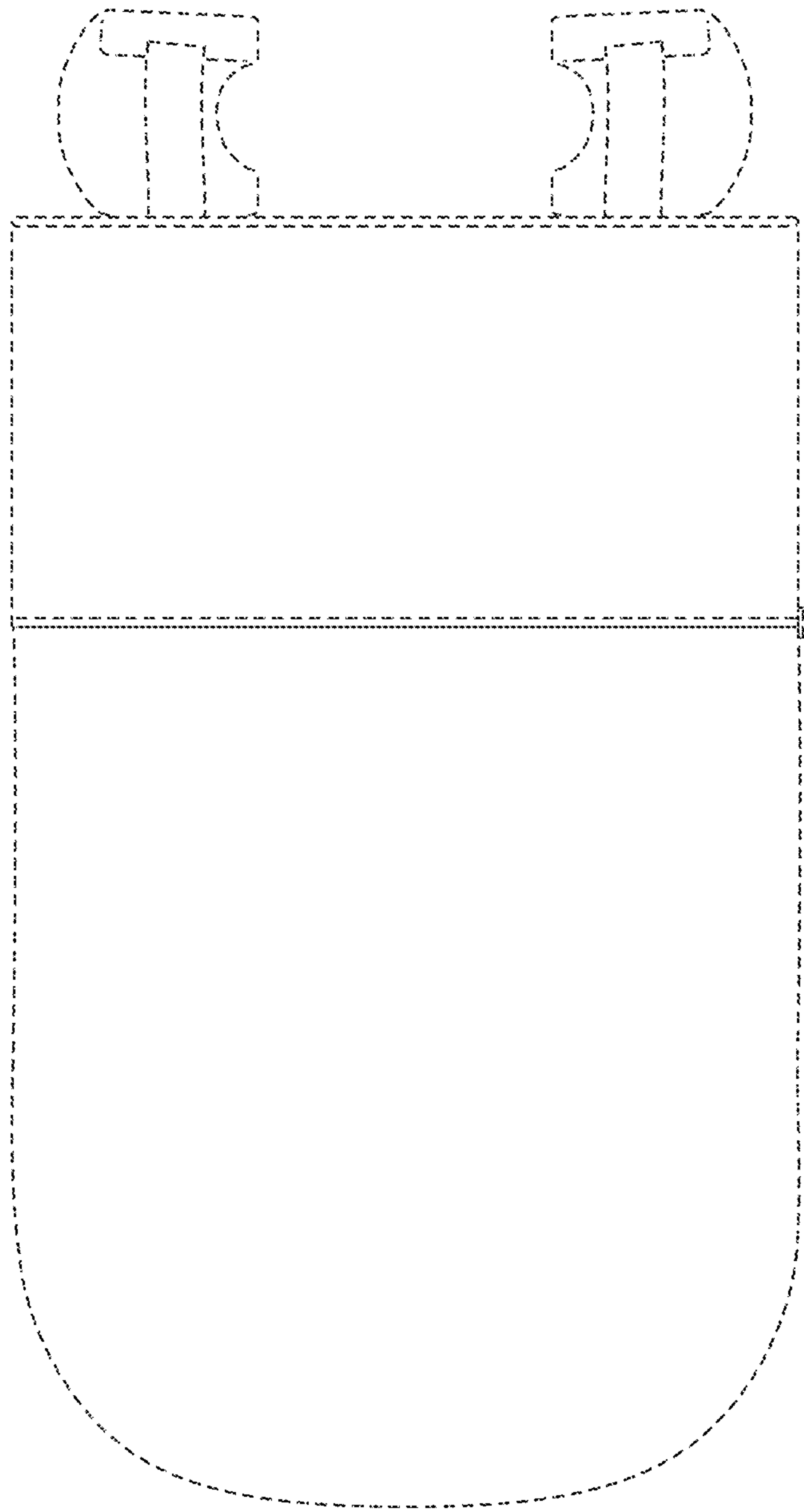

Fig. 28

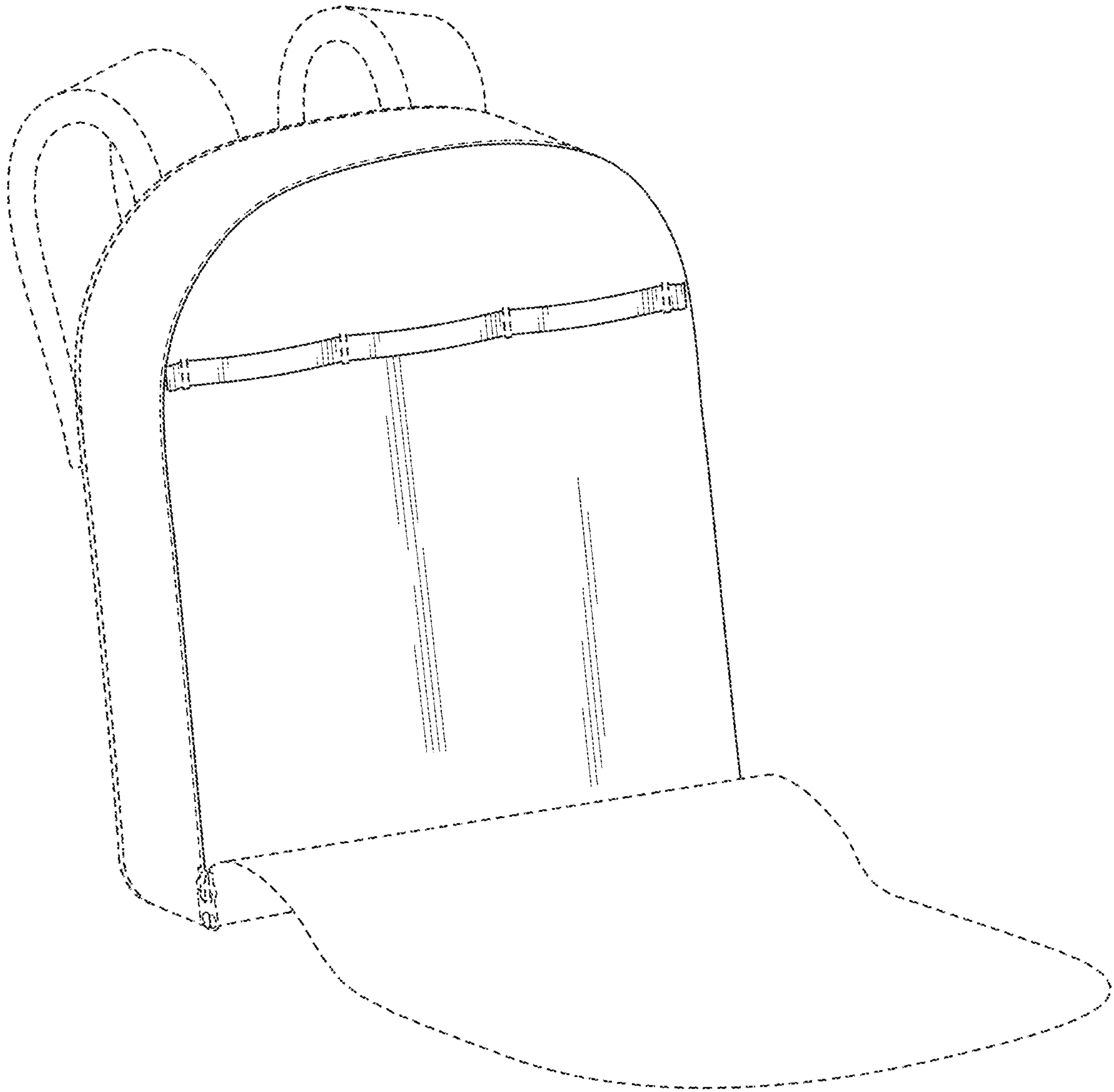

Fig. 29

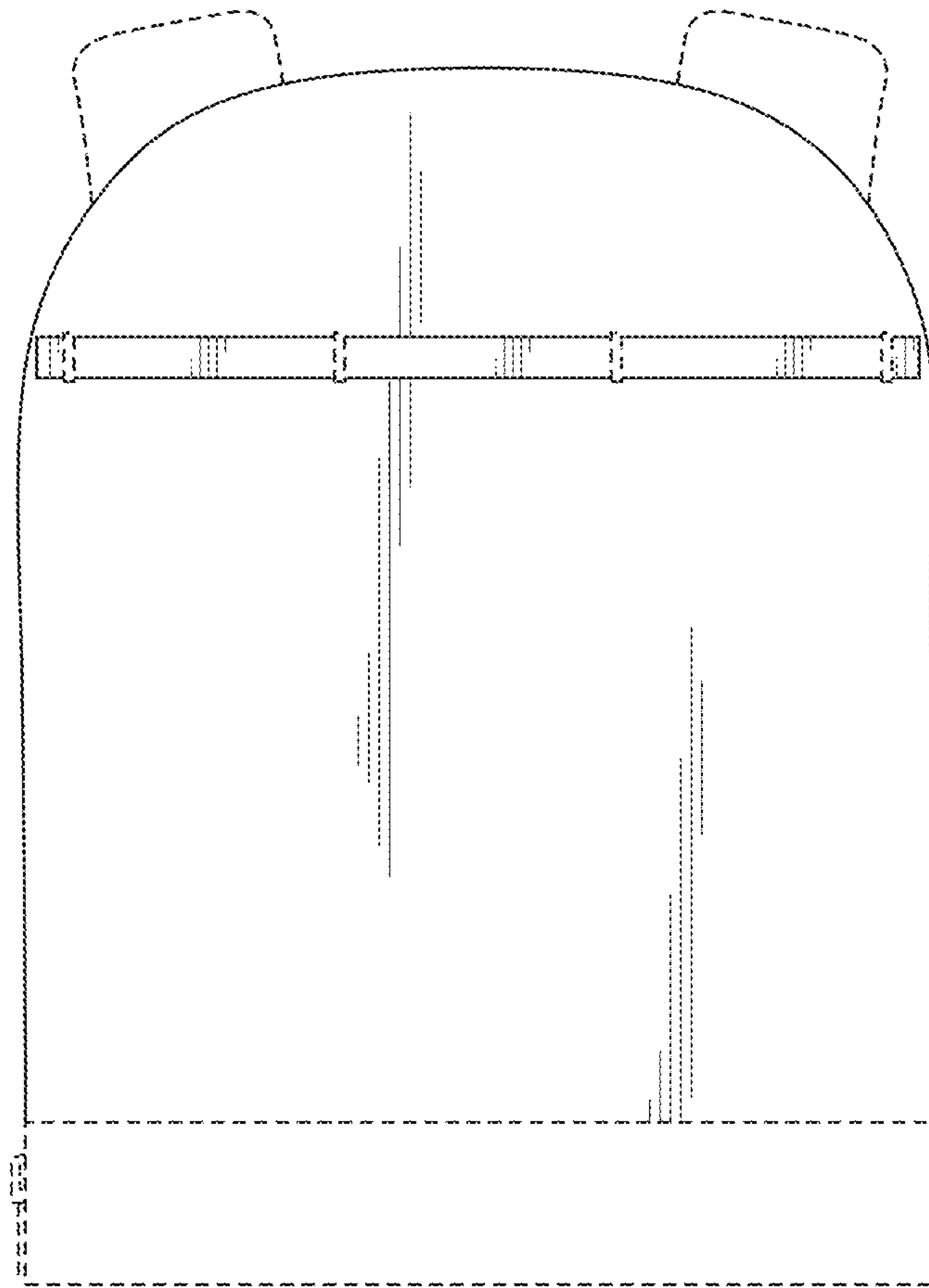

Fig. 30

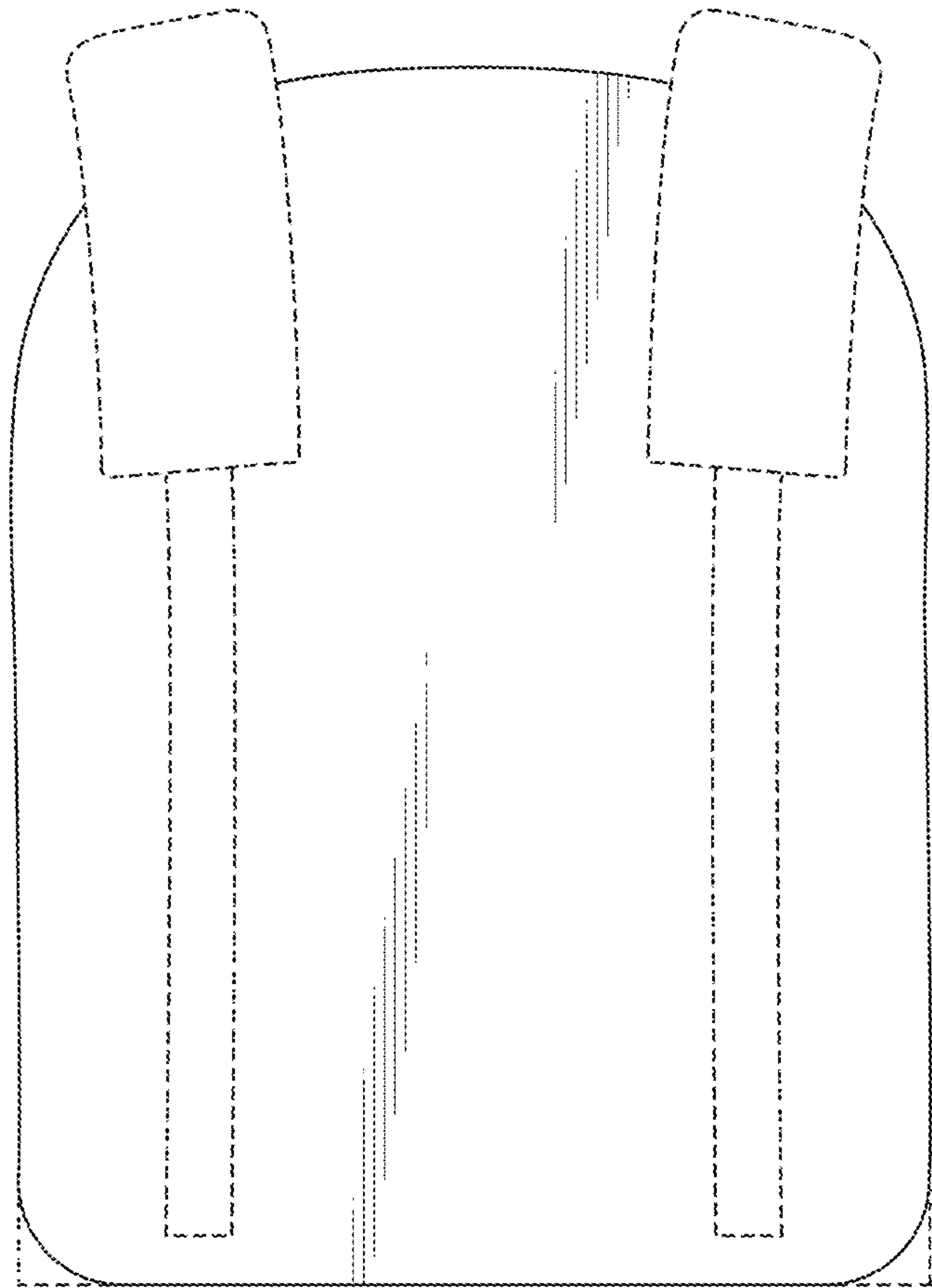

Fig. 31

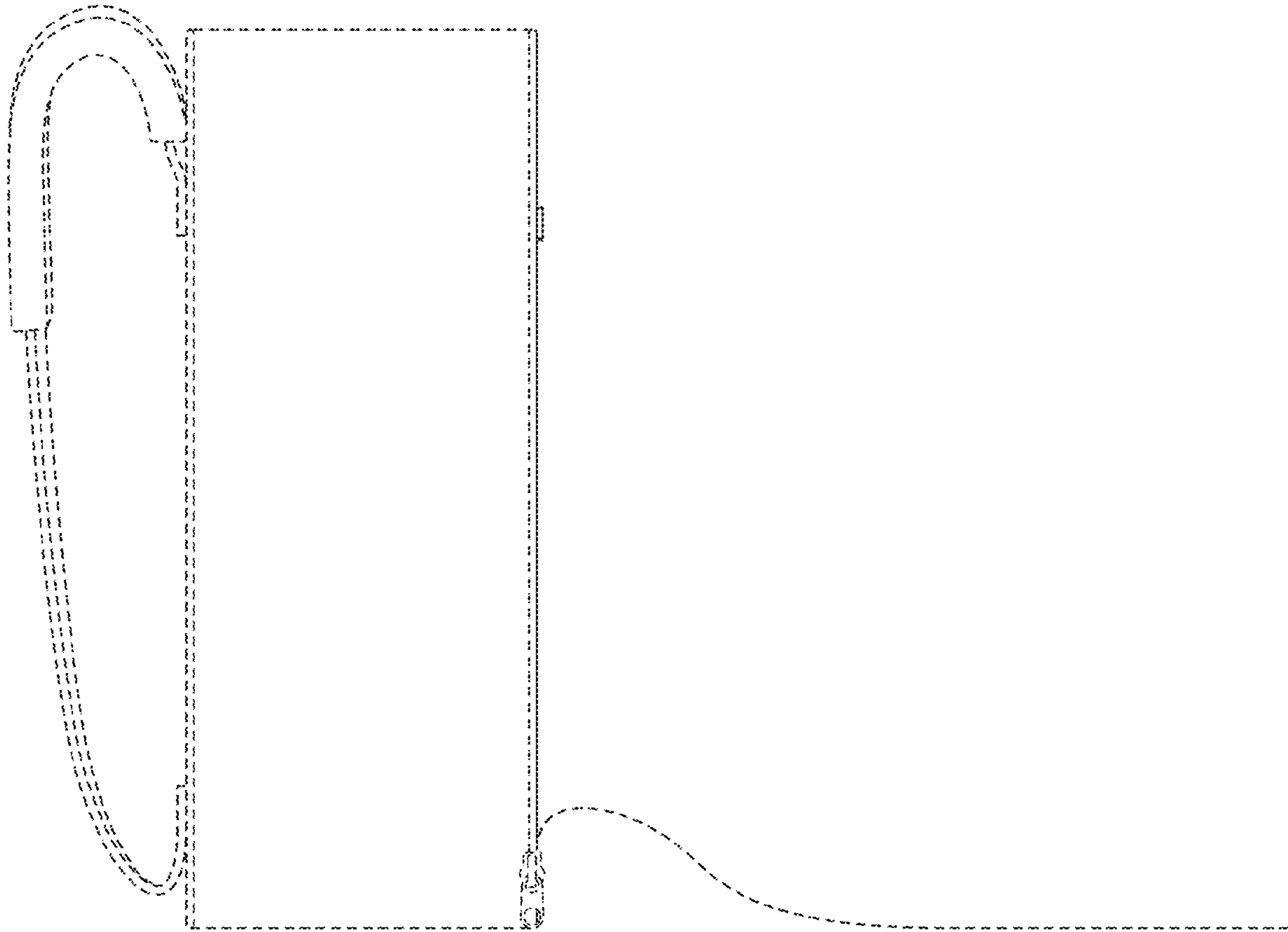

Fig. 32

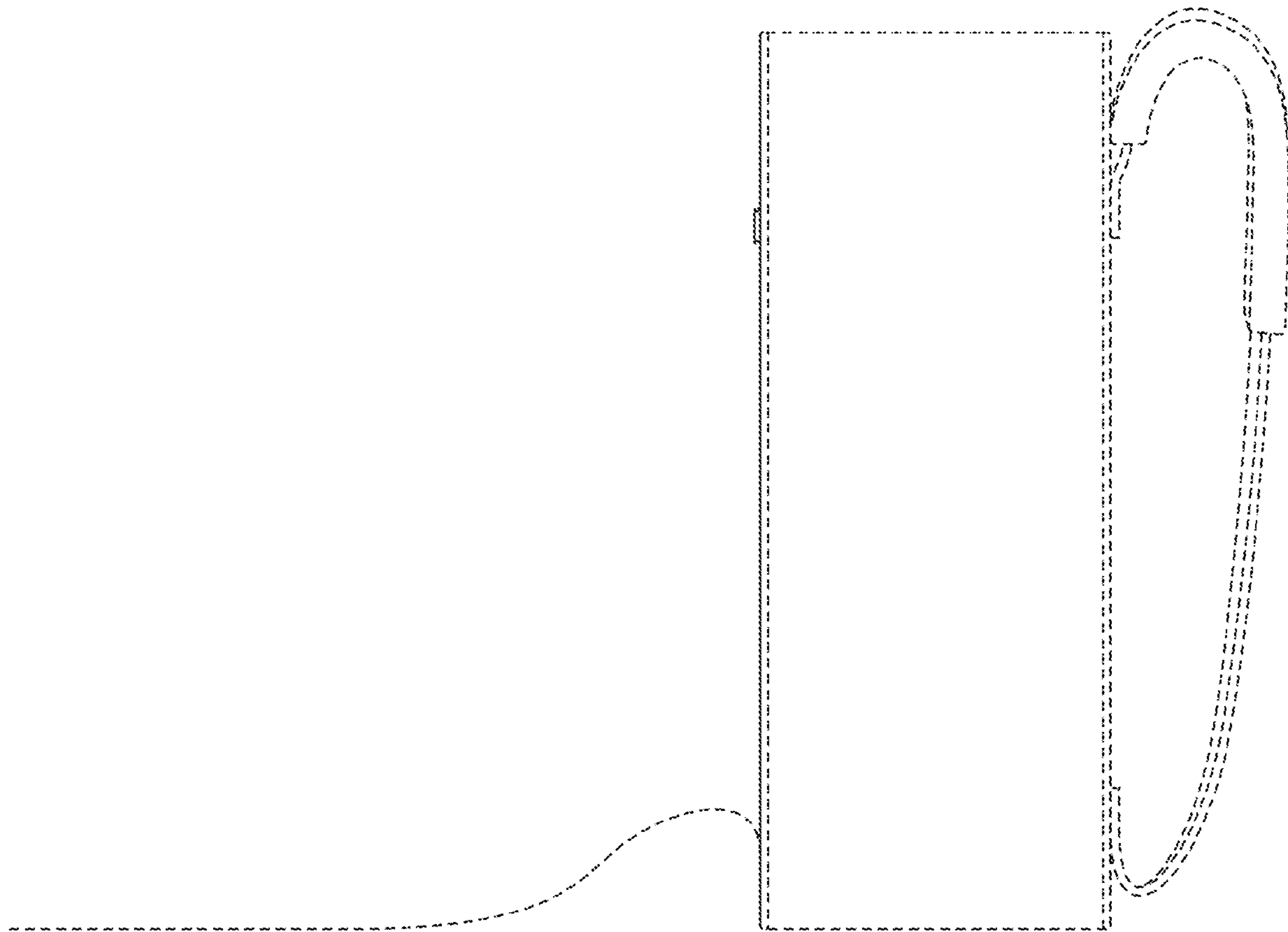

Fig. 33

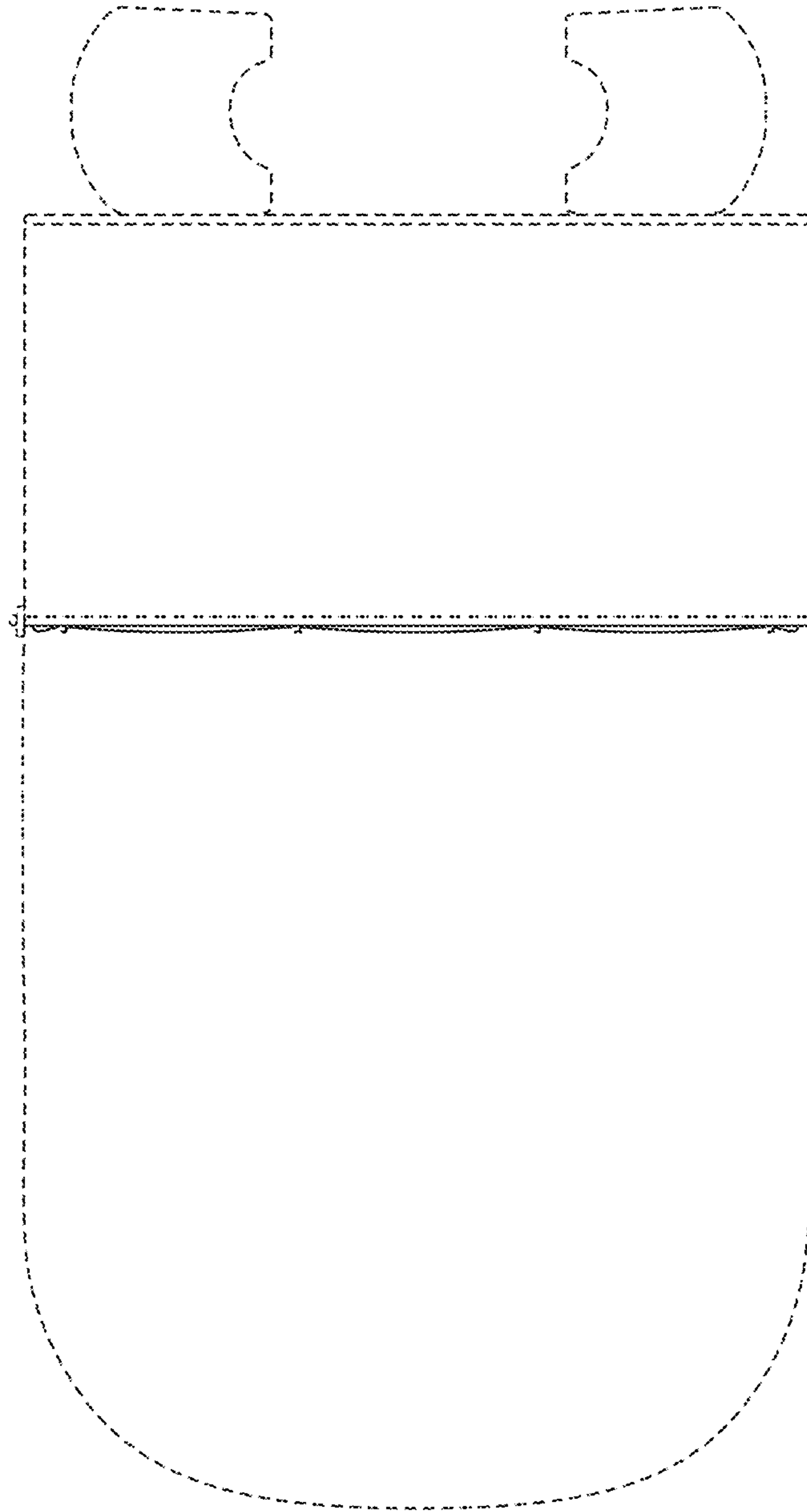

Fig. 34

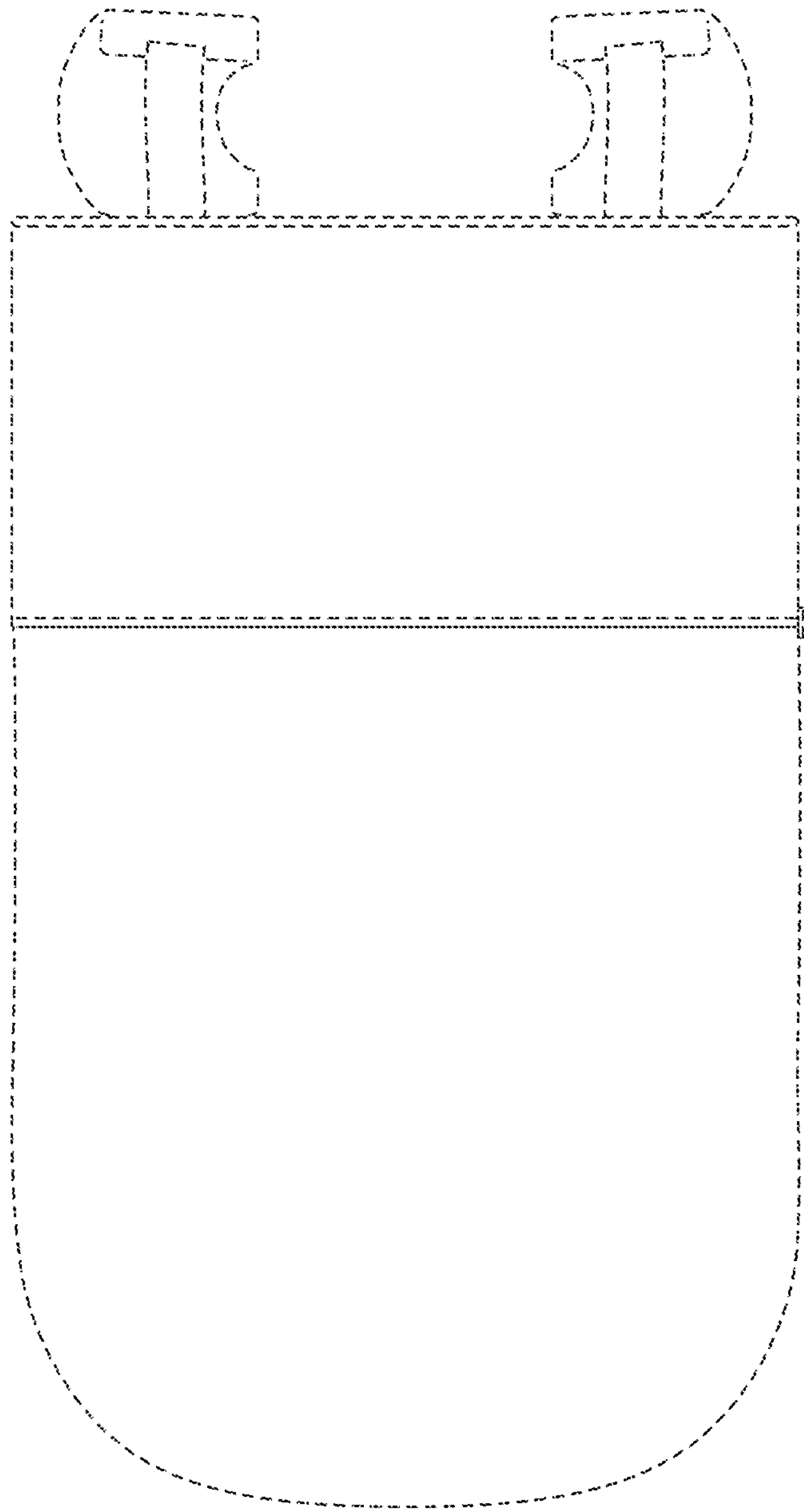

Fig. 35

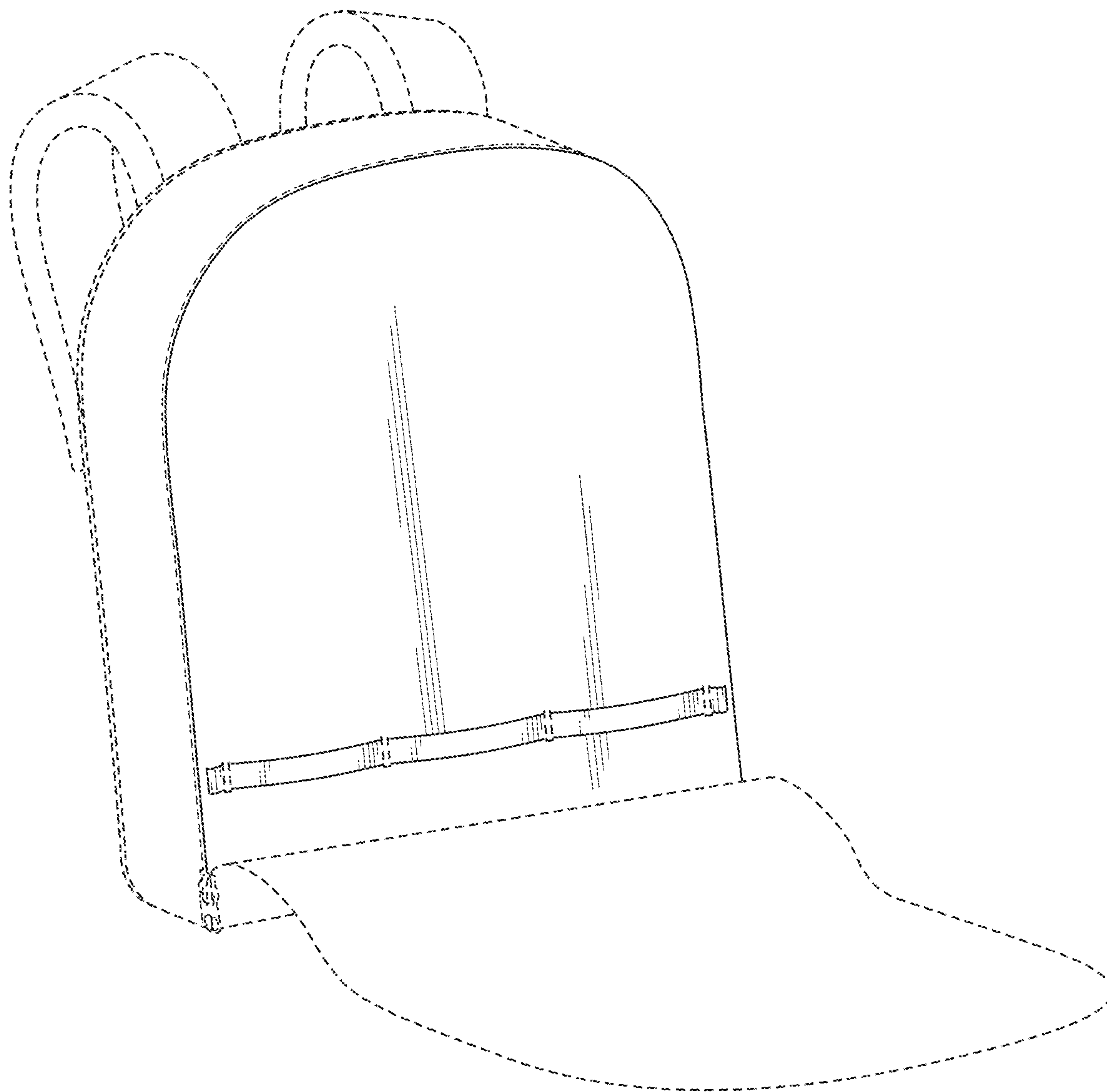

Fig. 36

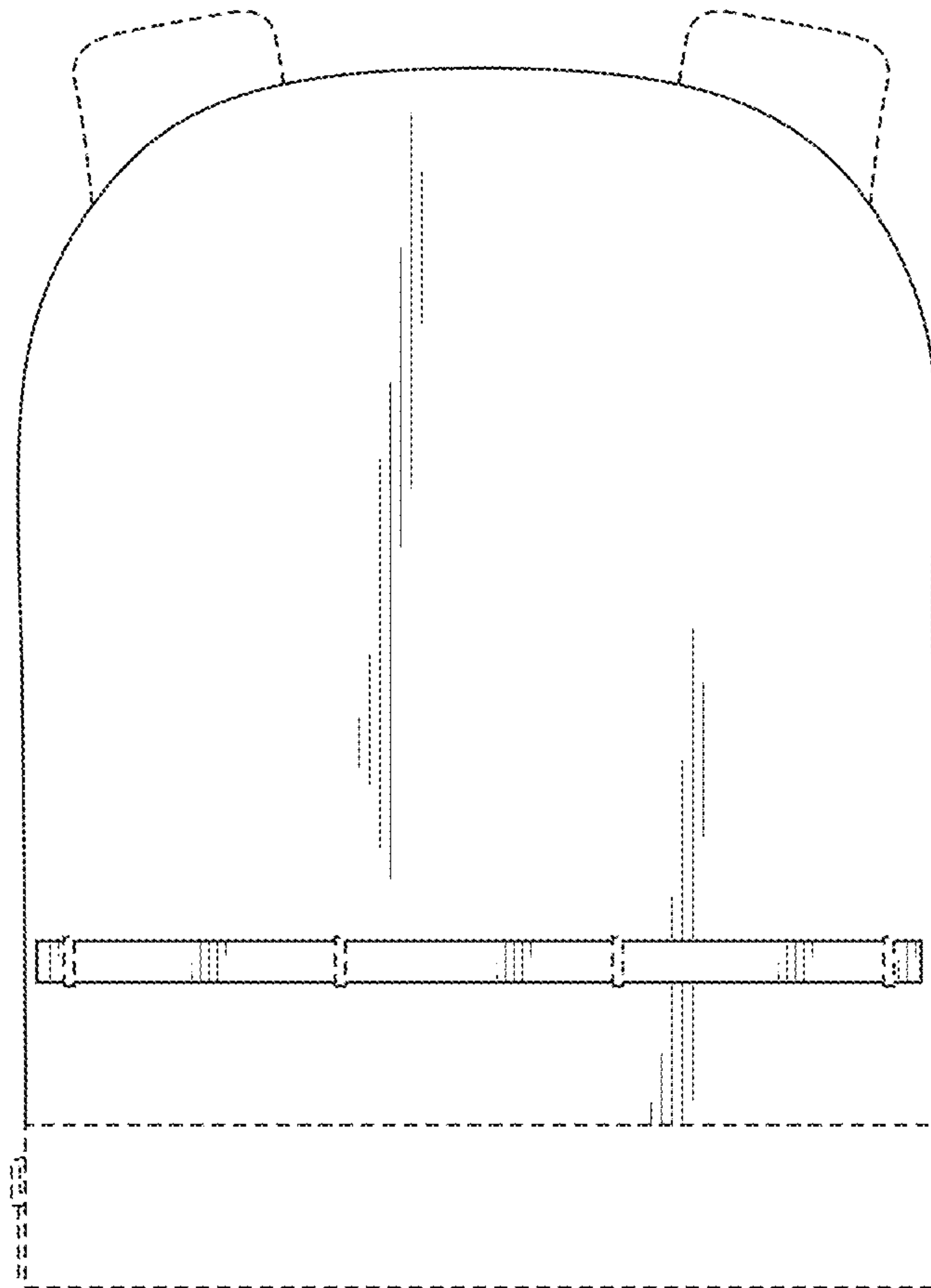

Fig. 37

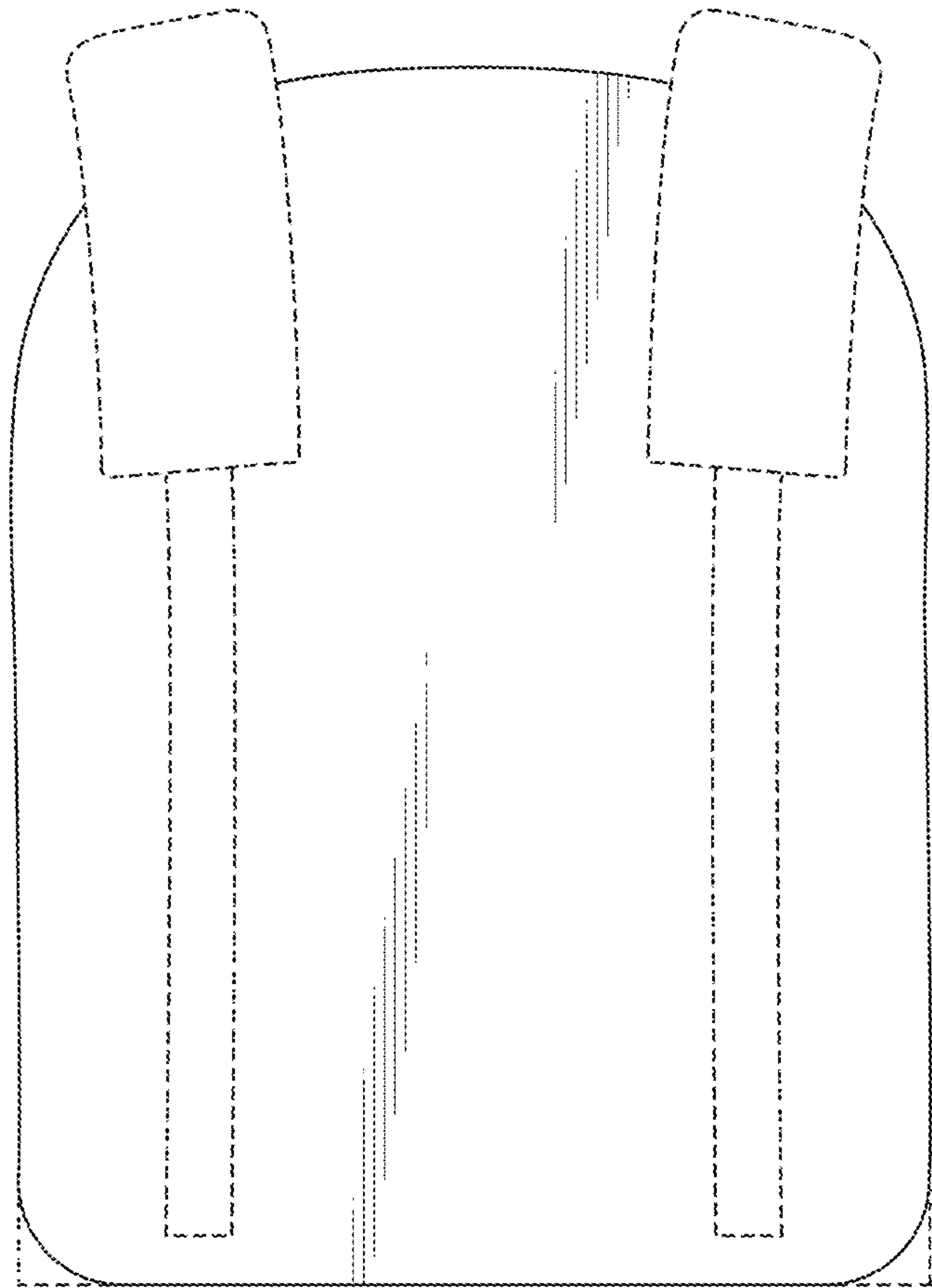

Fig. 38

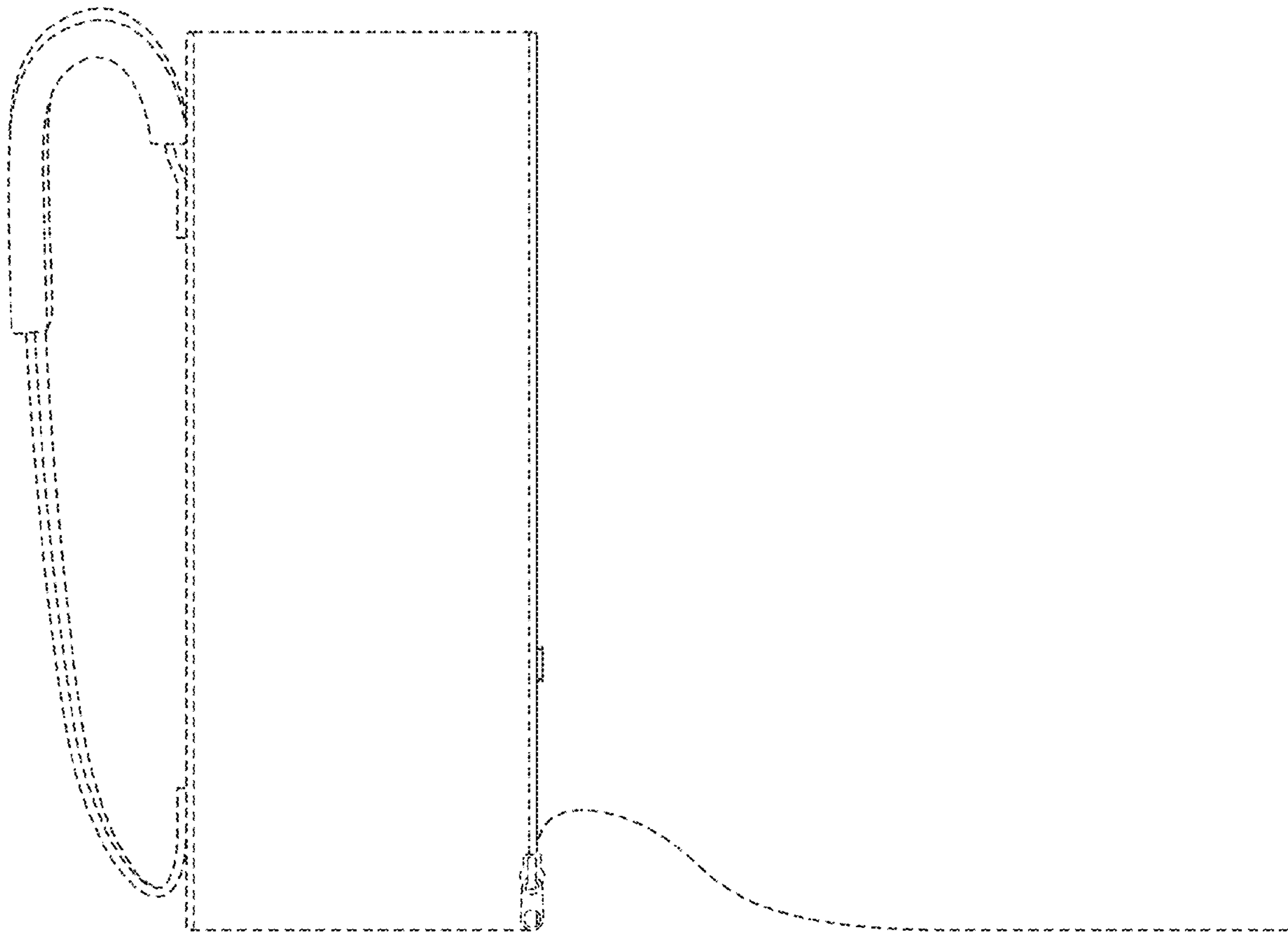

Fig. 39

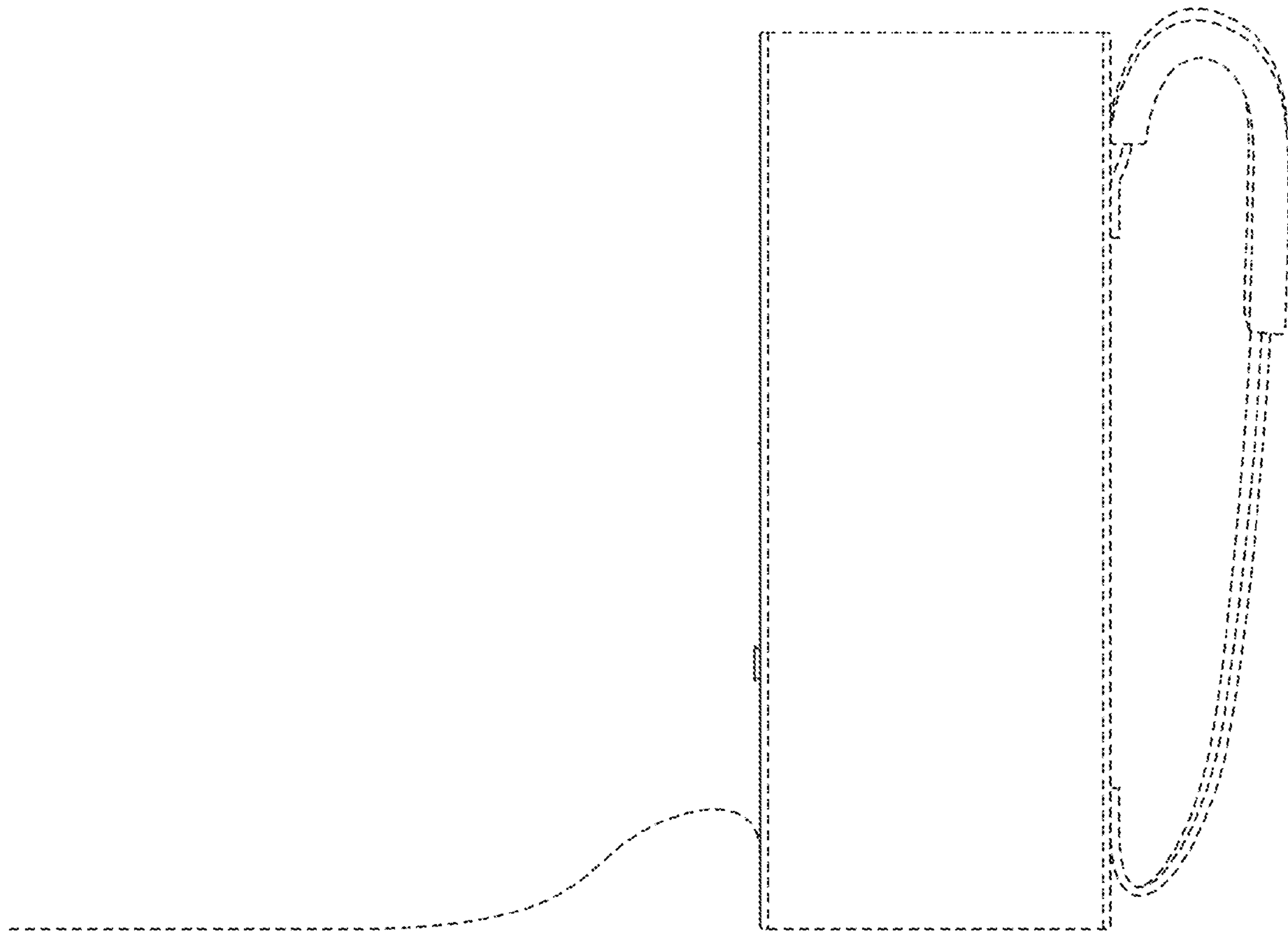

Fig. 40

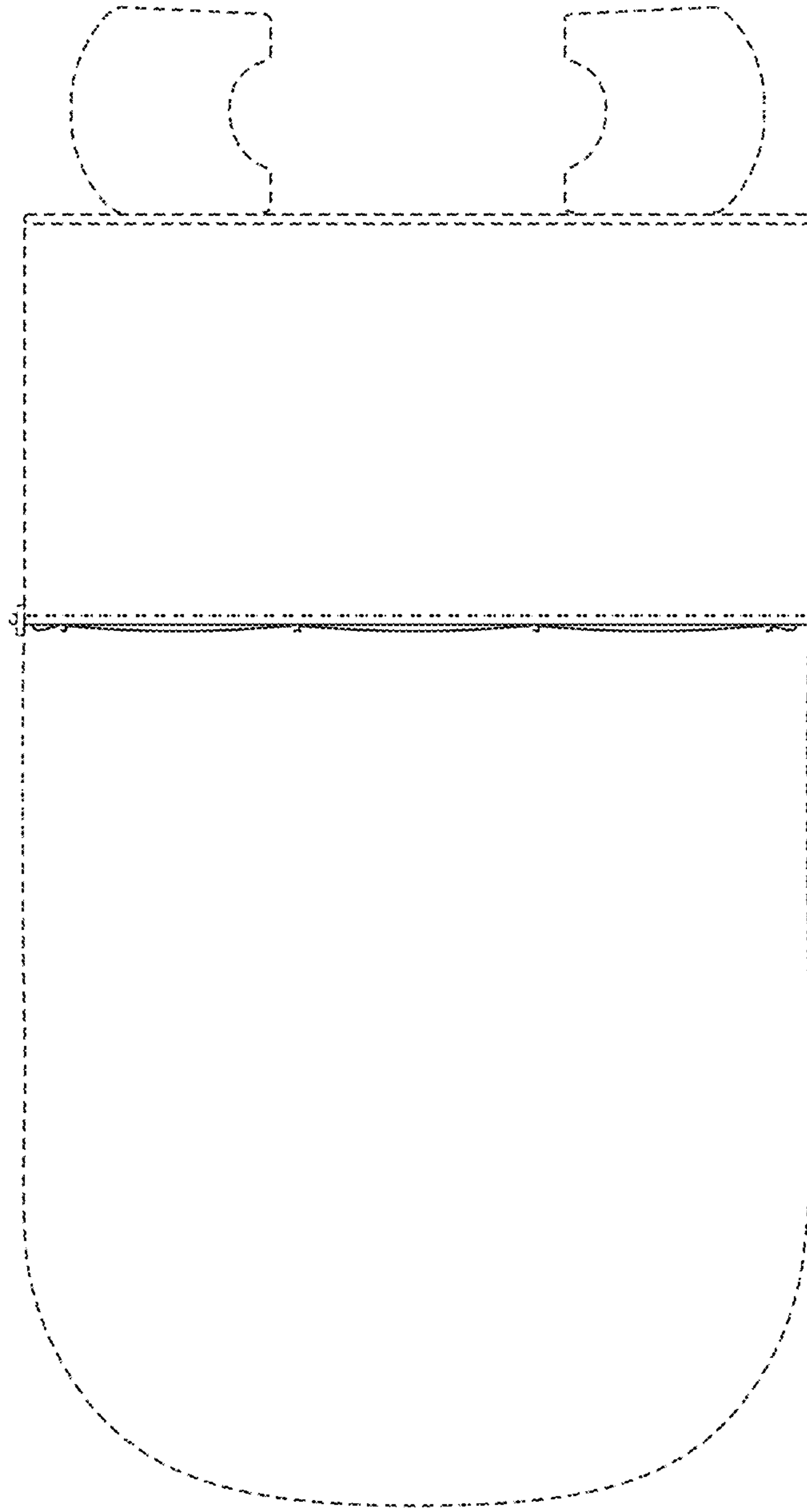

Fig. 41

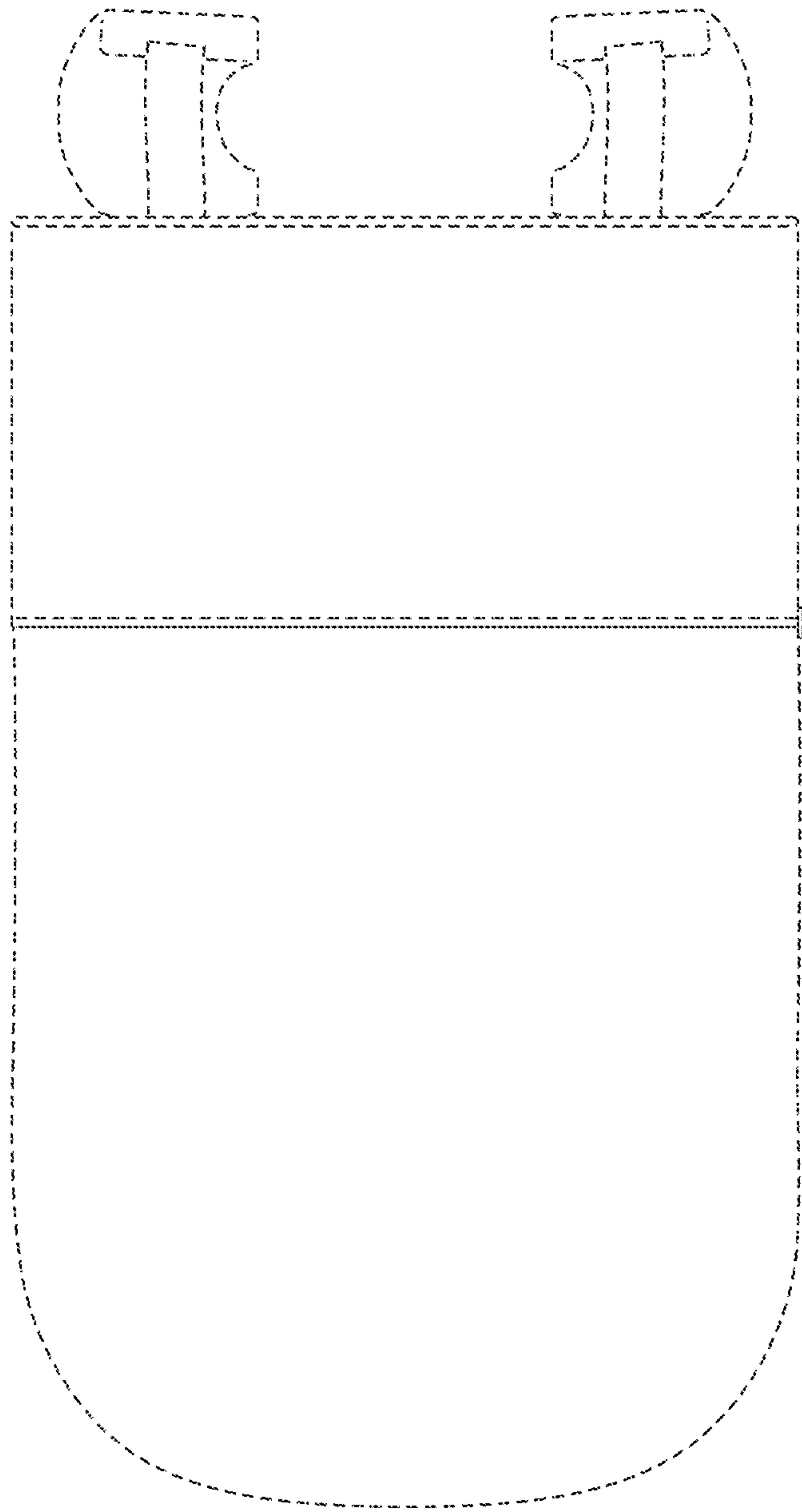

Fig. 42

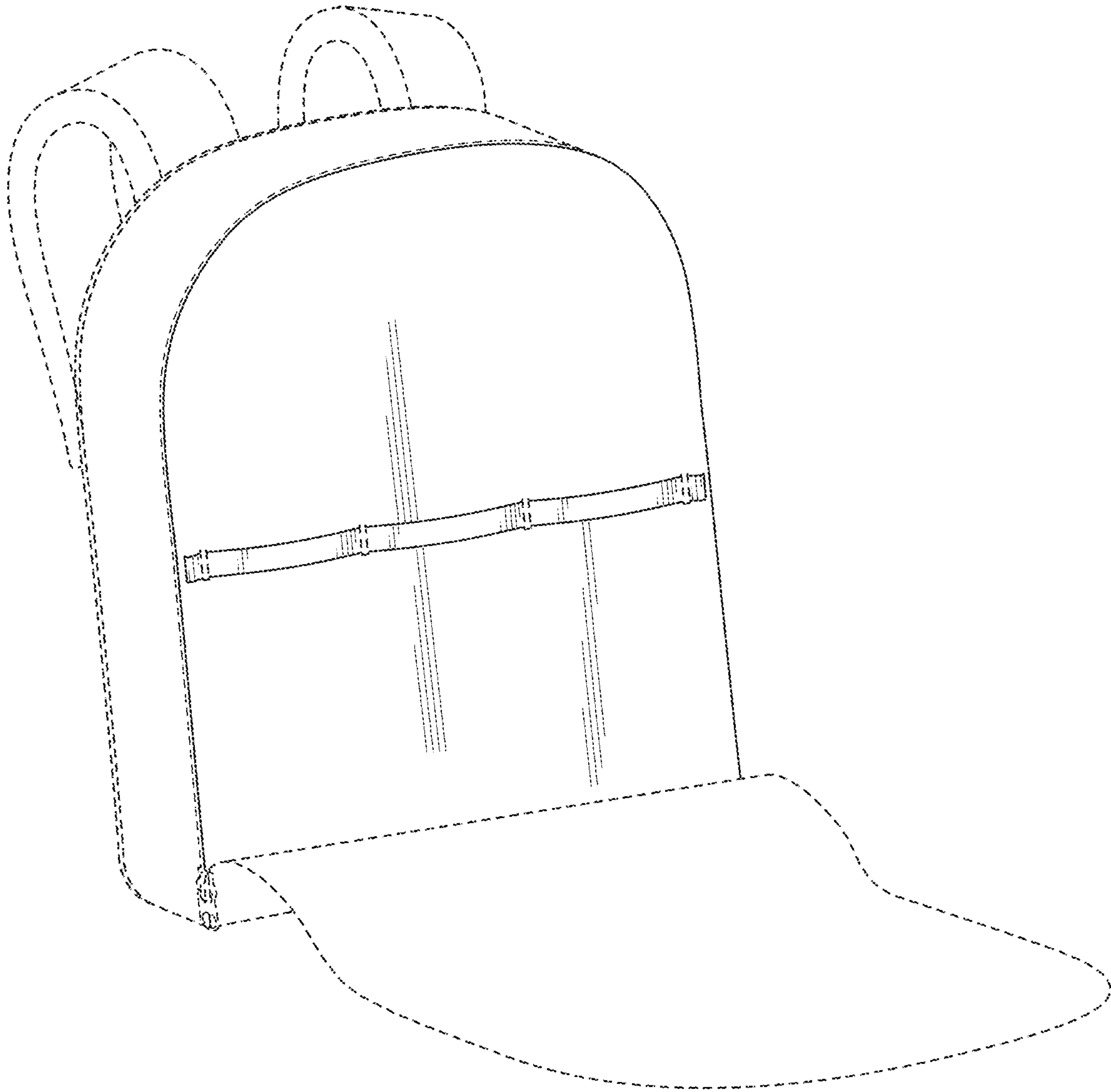

Fig. 43

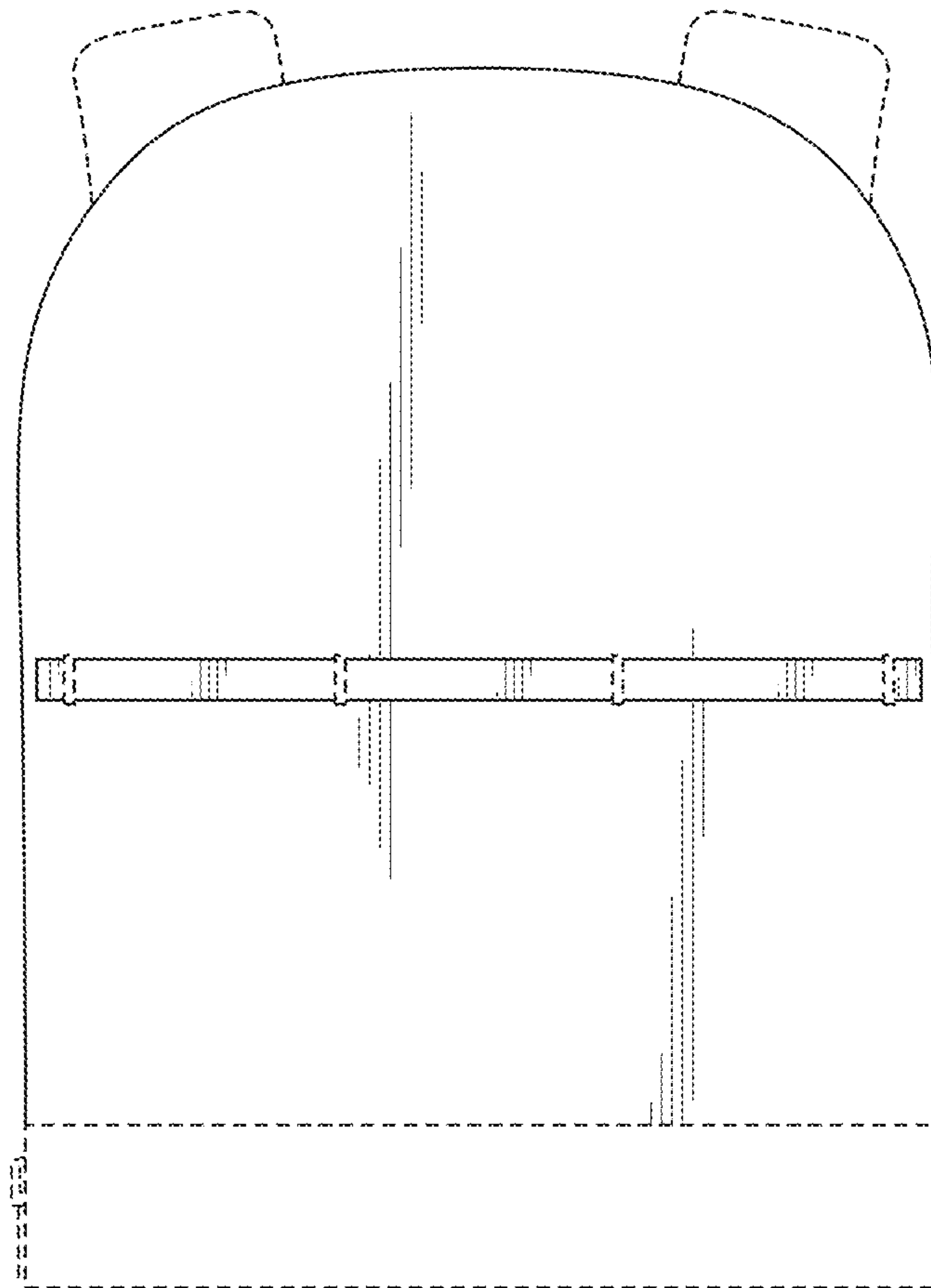

Fig. 44

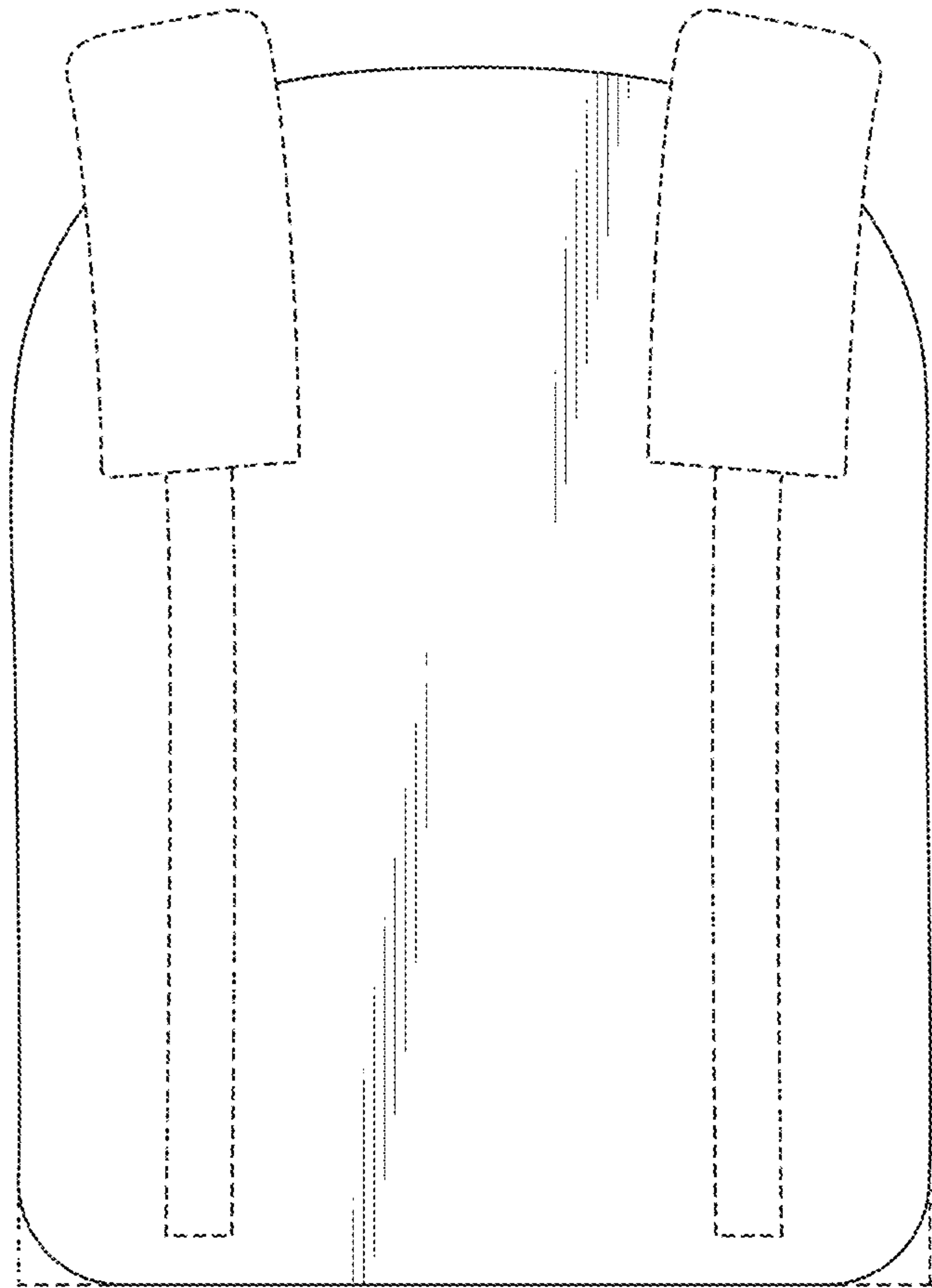

Fig. 45

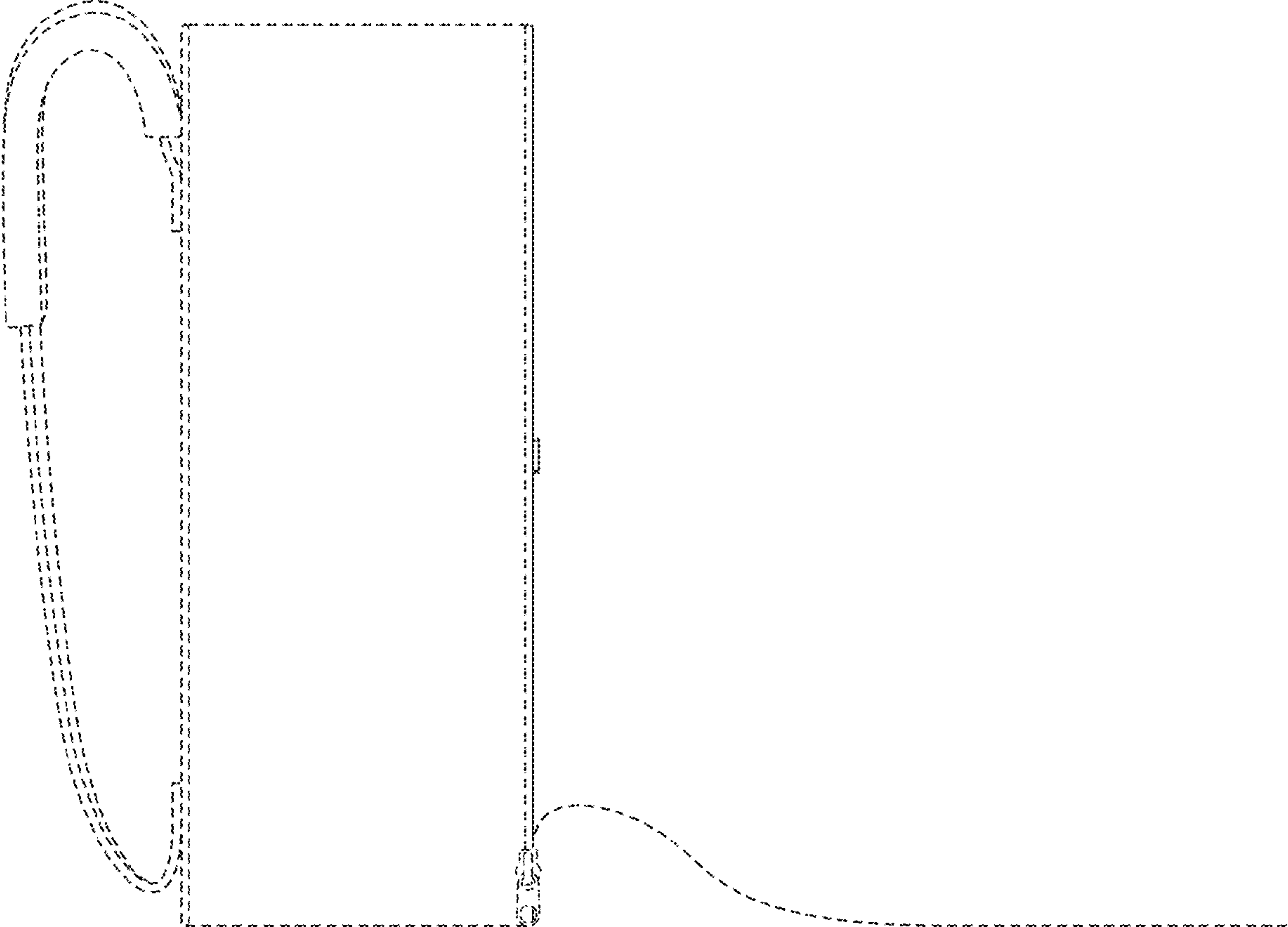

Fig. 46

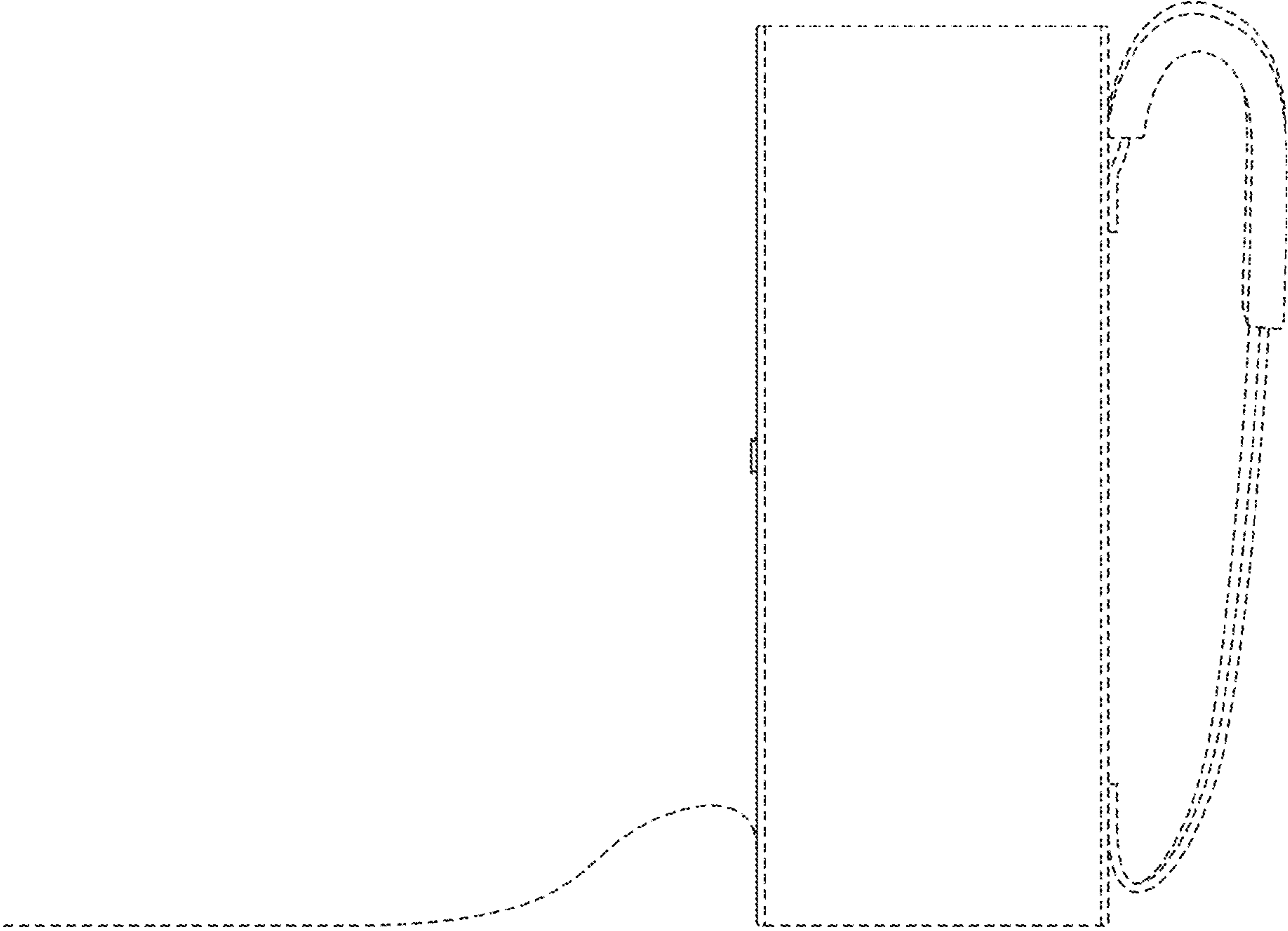

Fig. 47

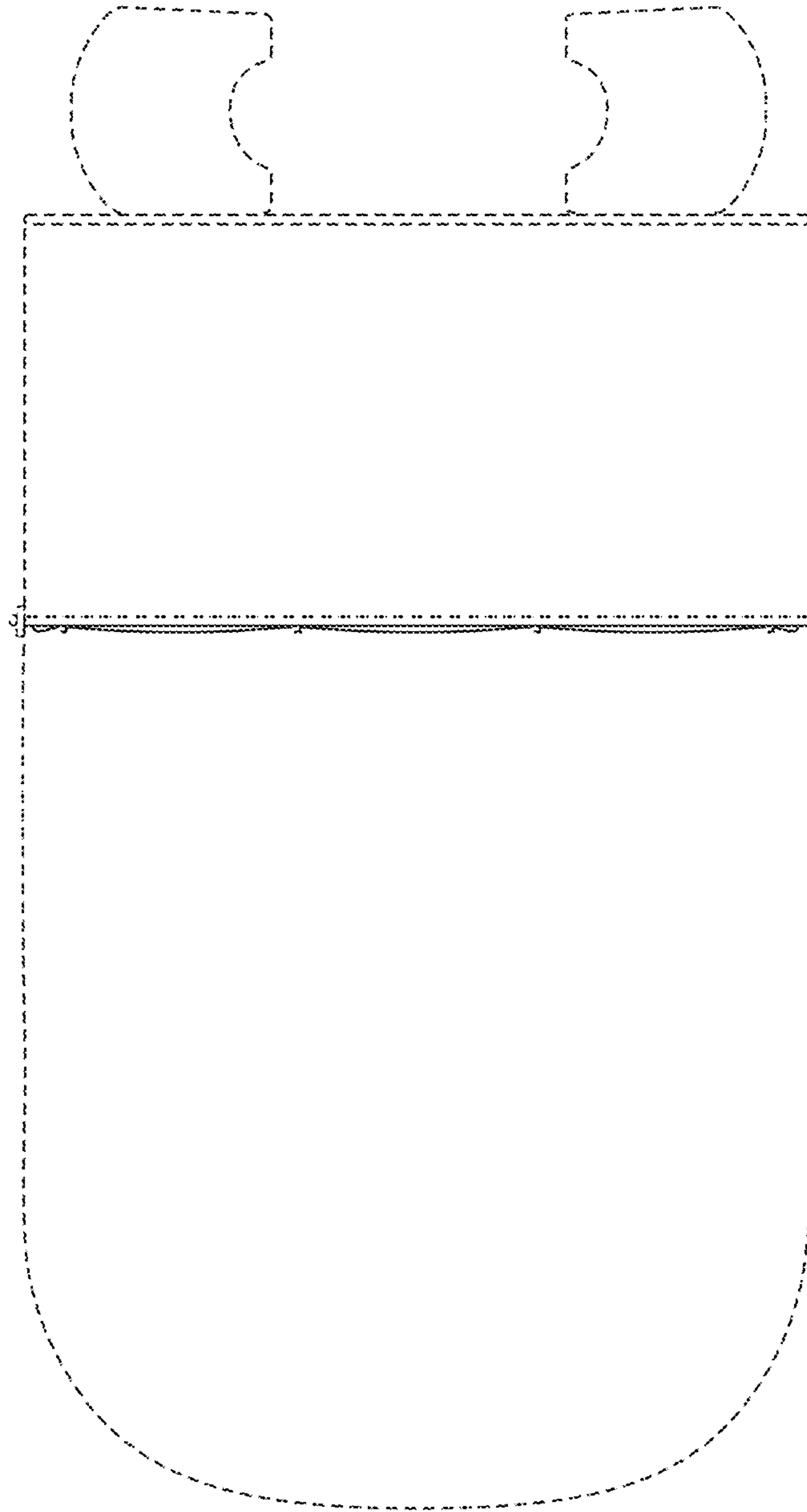

Fig. 48

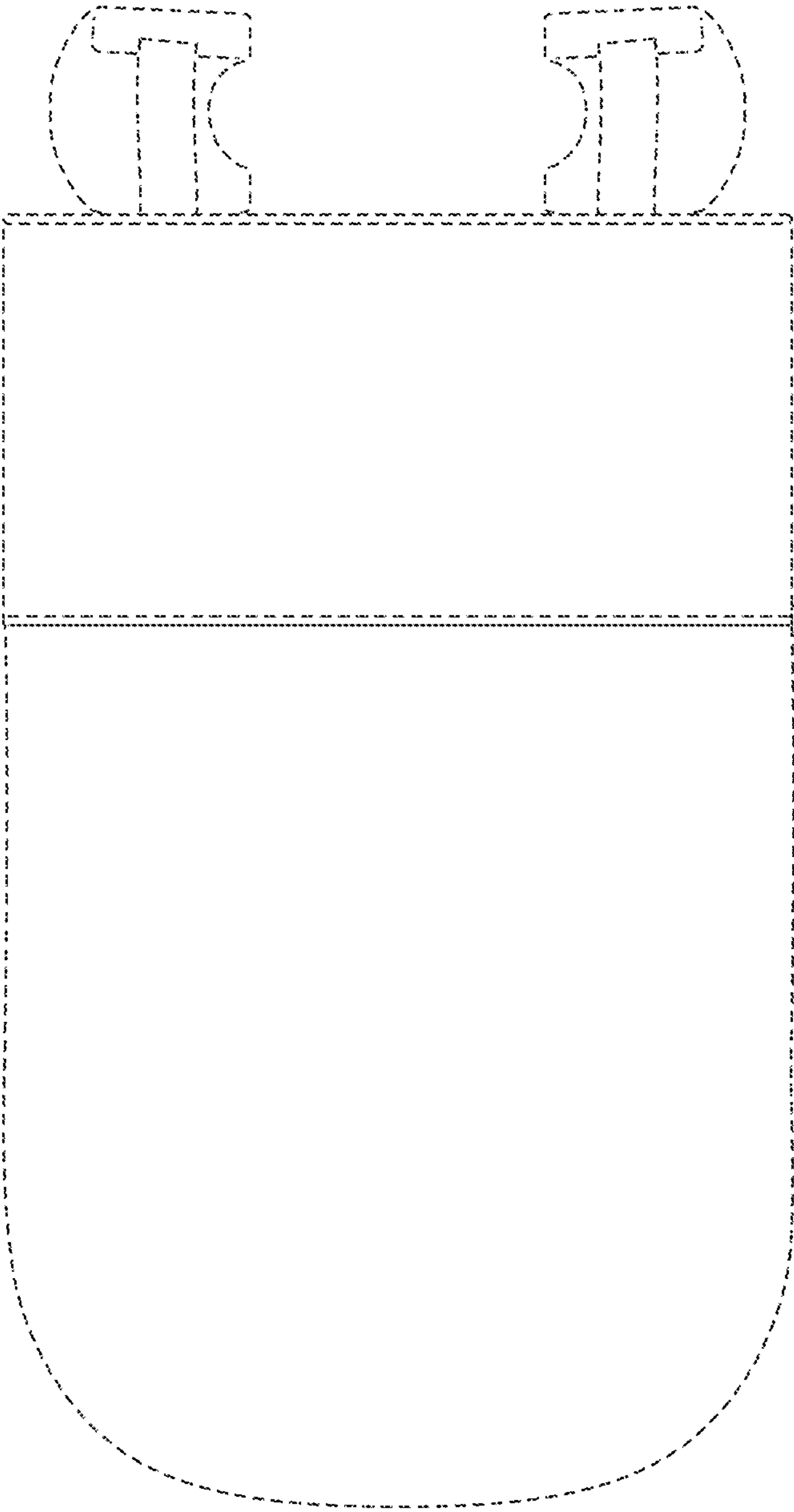

Fig. 49

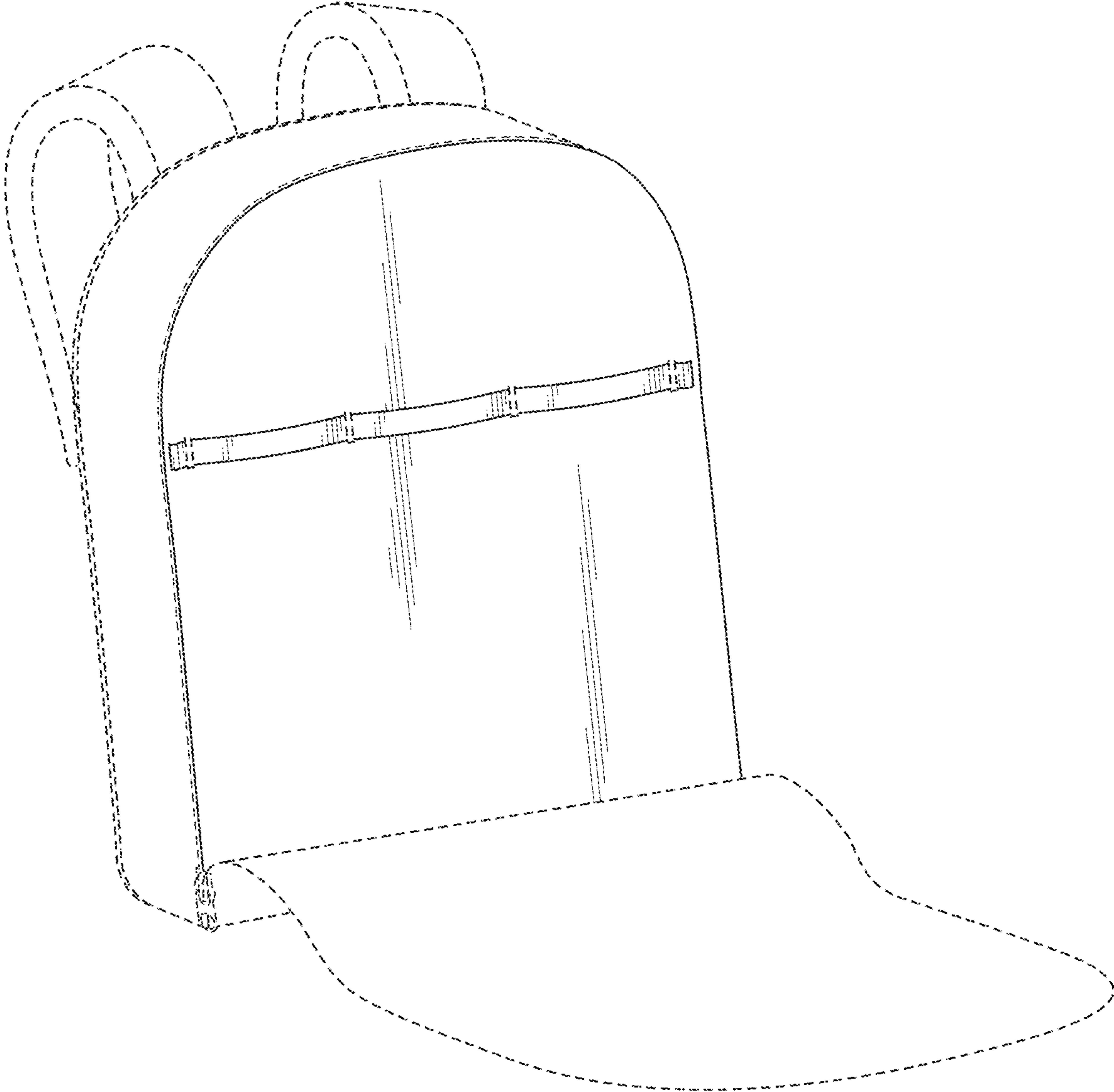

FIG. 50

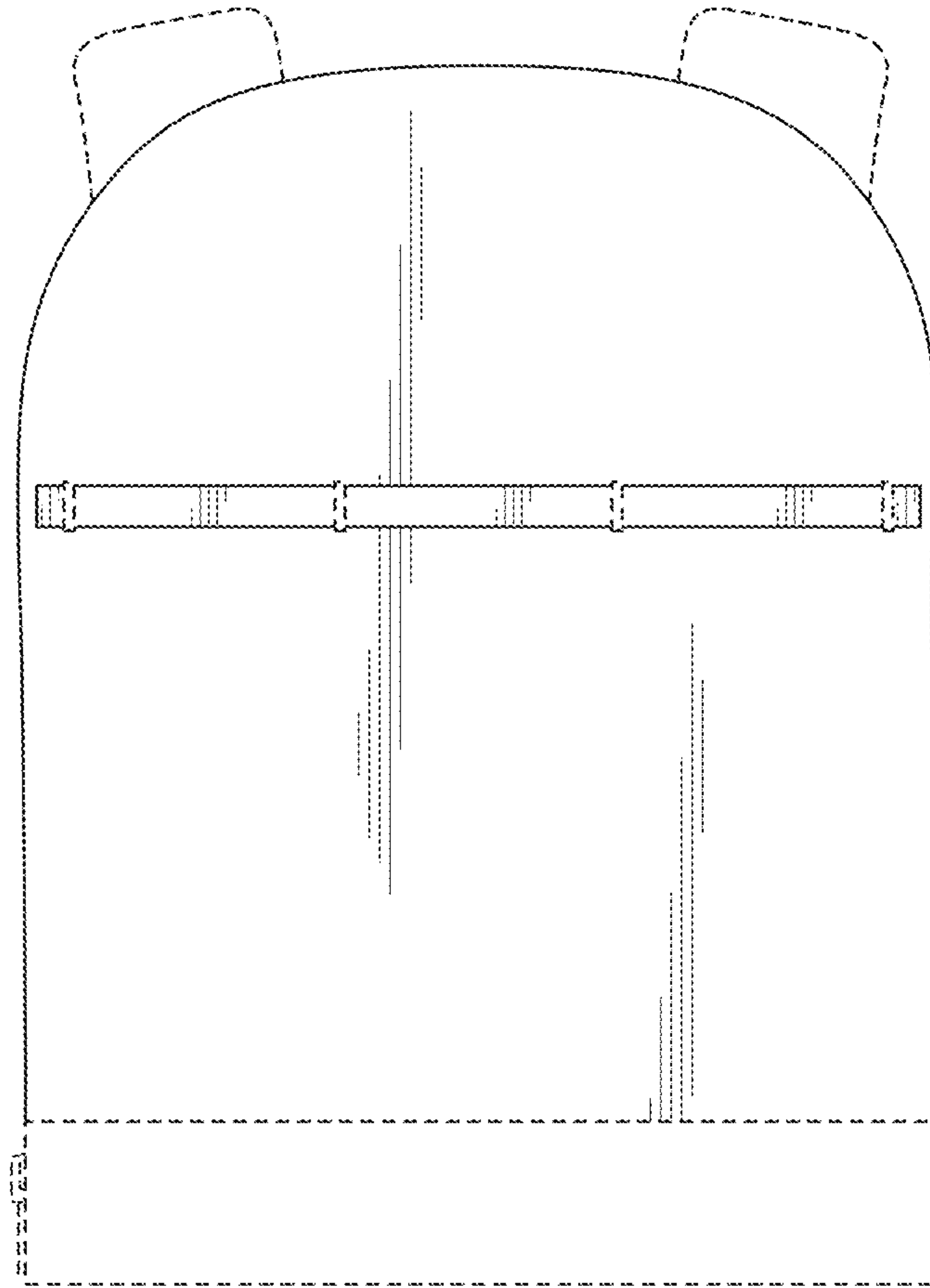

FIG. 51

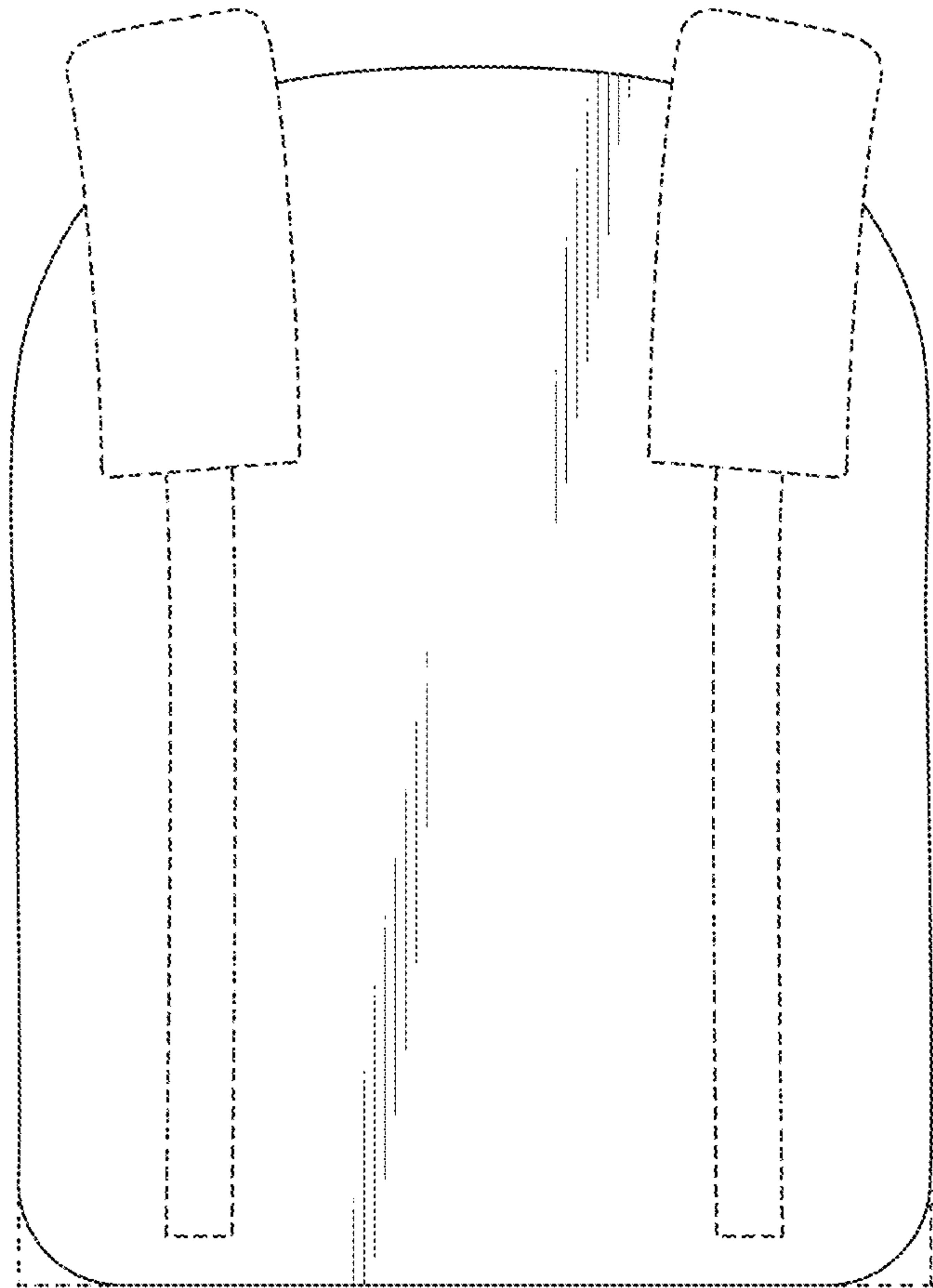

FIG. 52

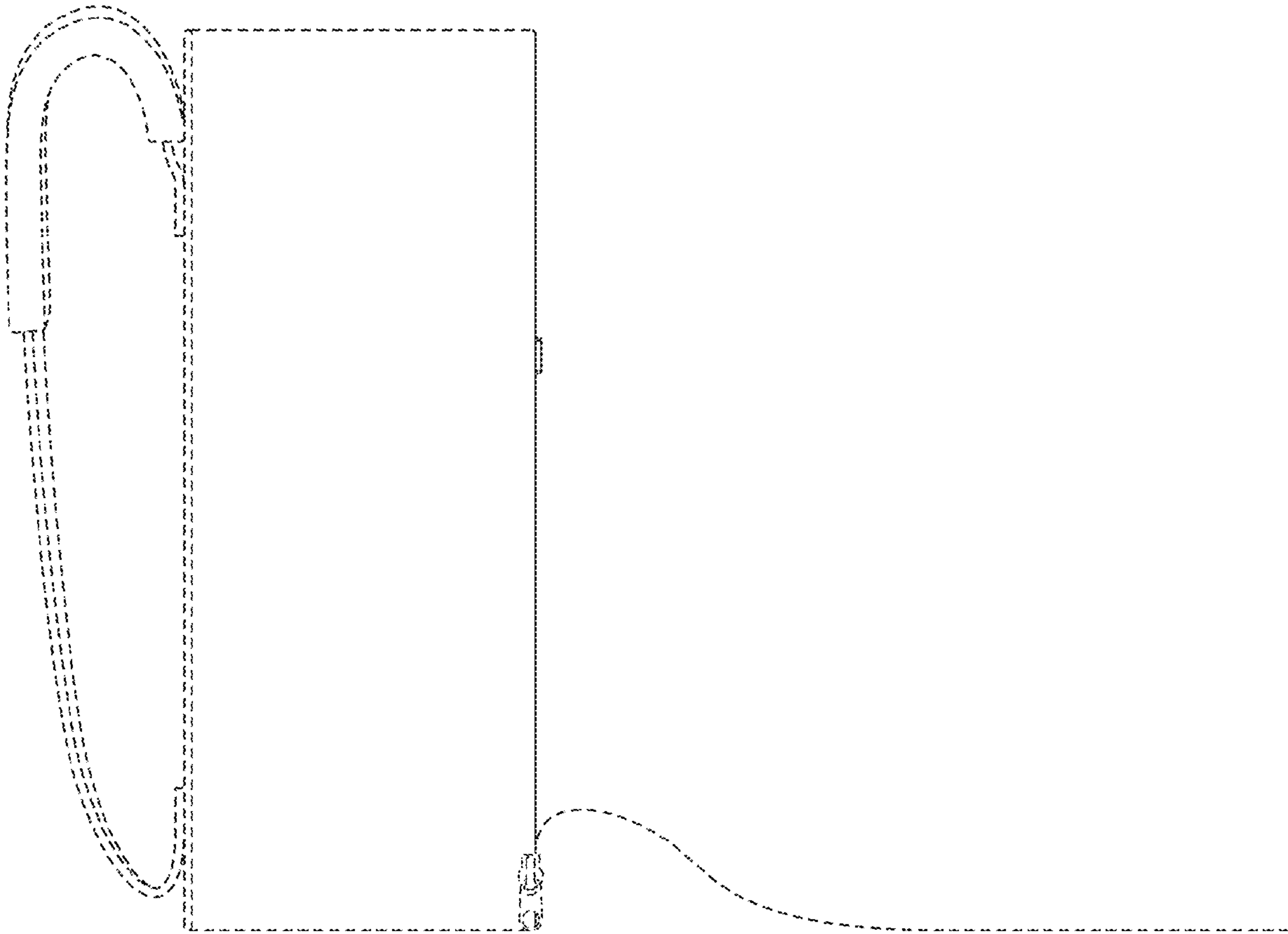

FIG. 53

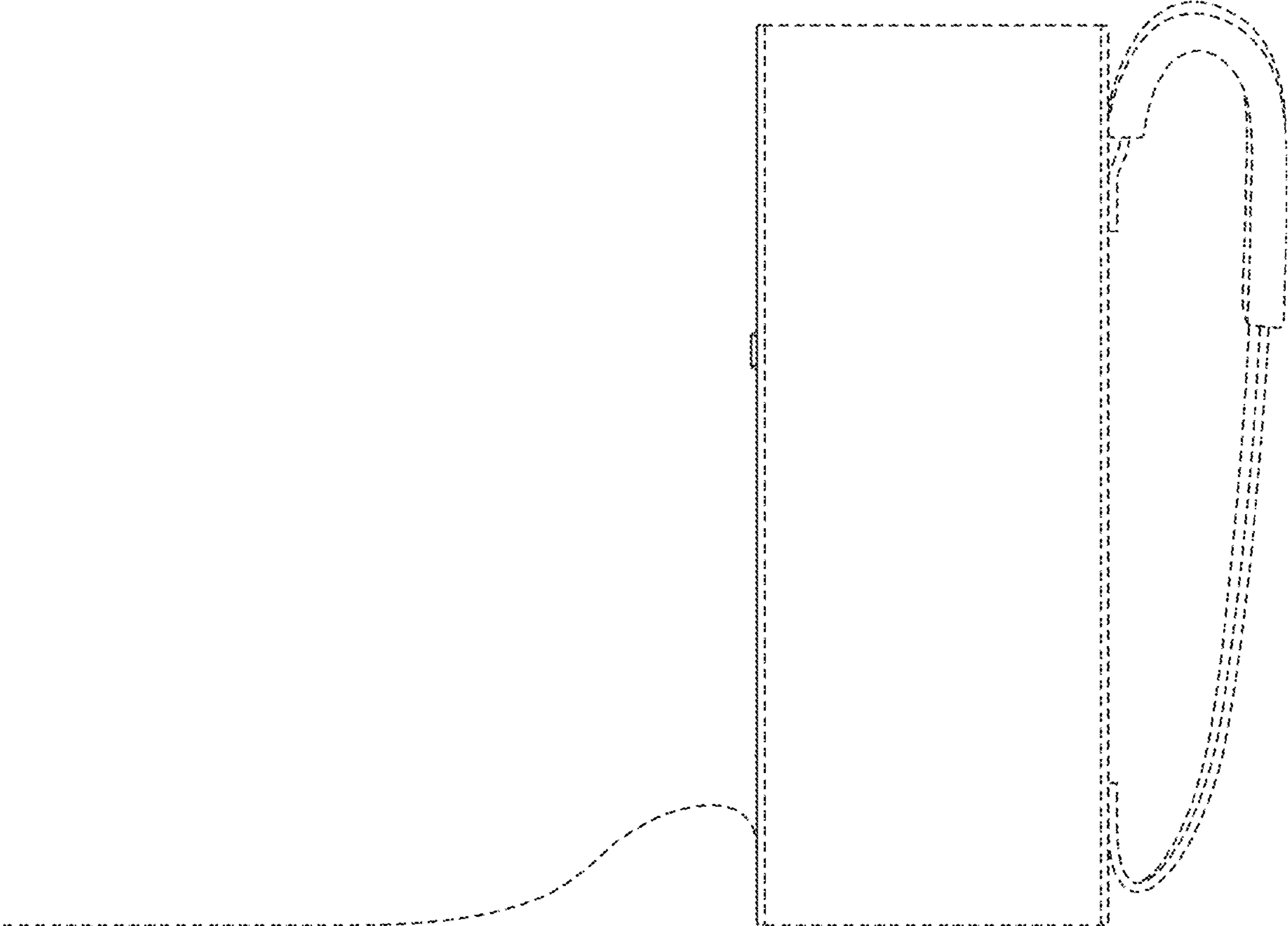

FIG. 54

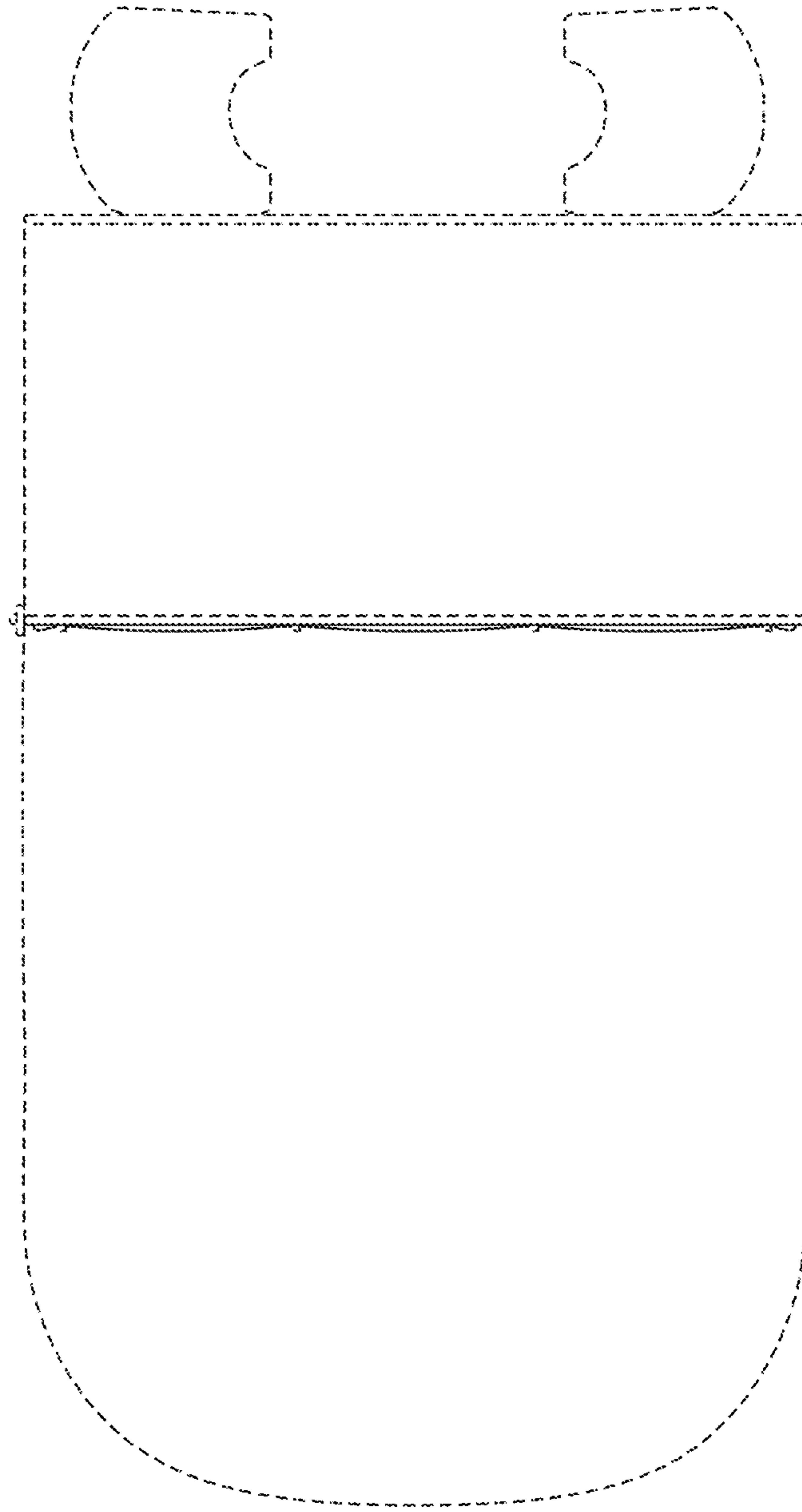

FIG. 55

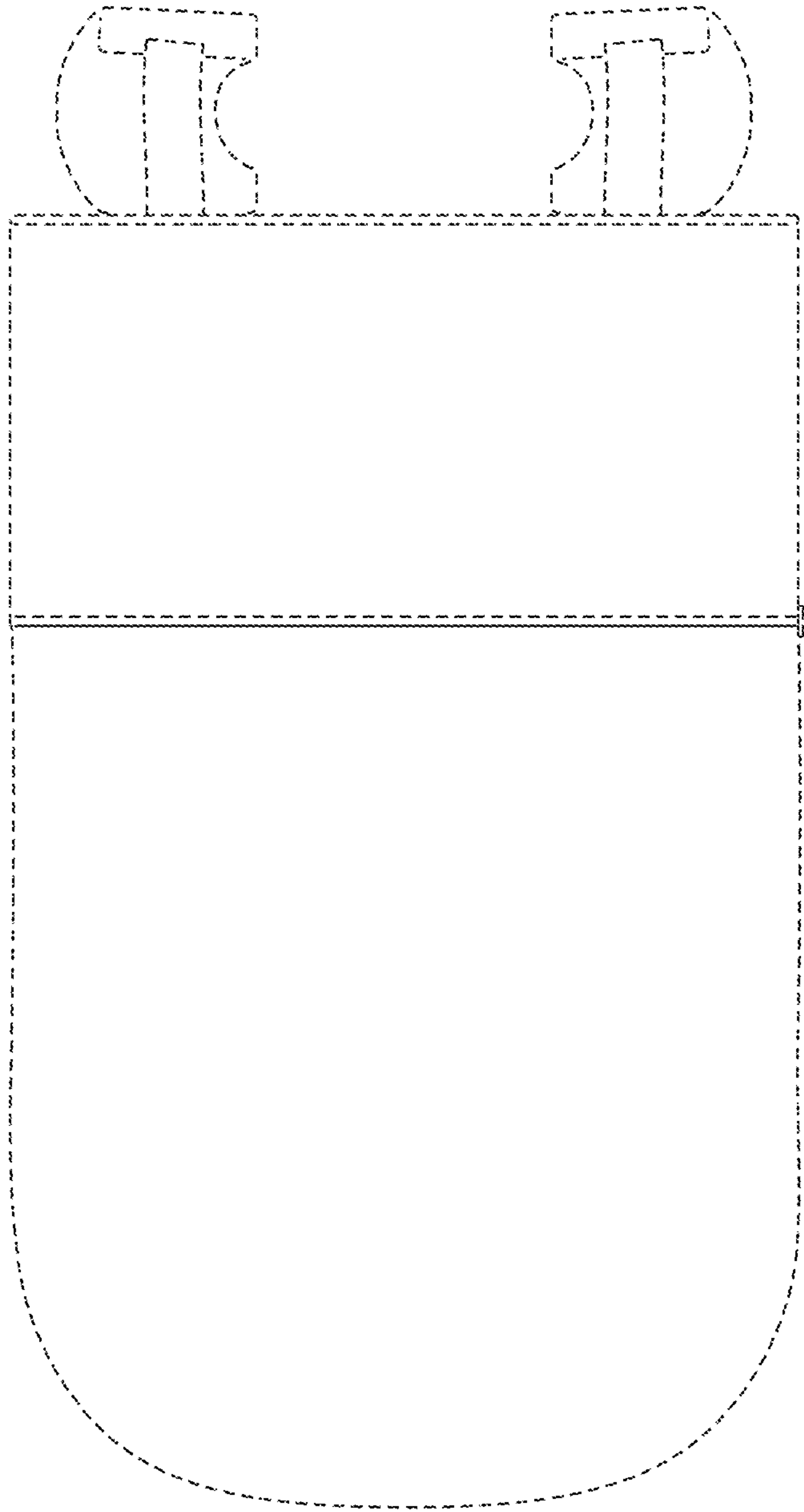

FIG. 56

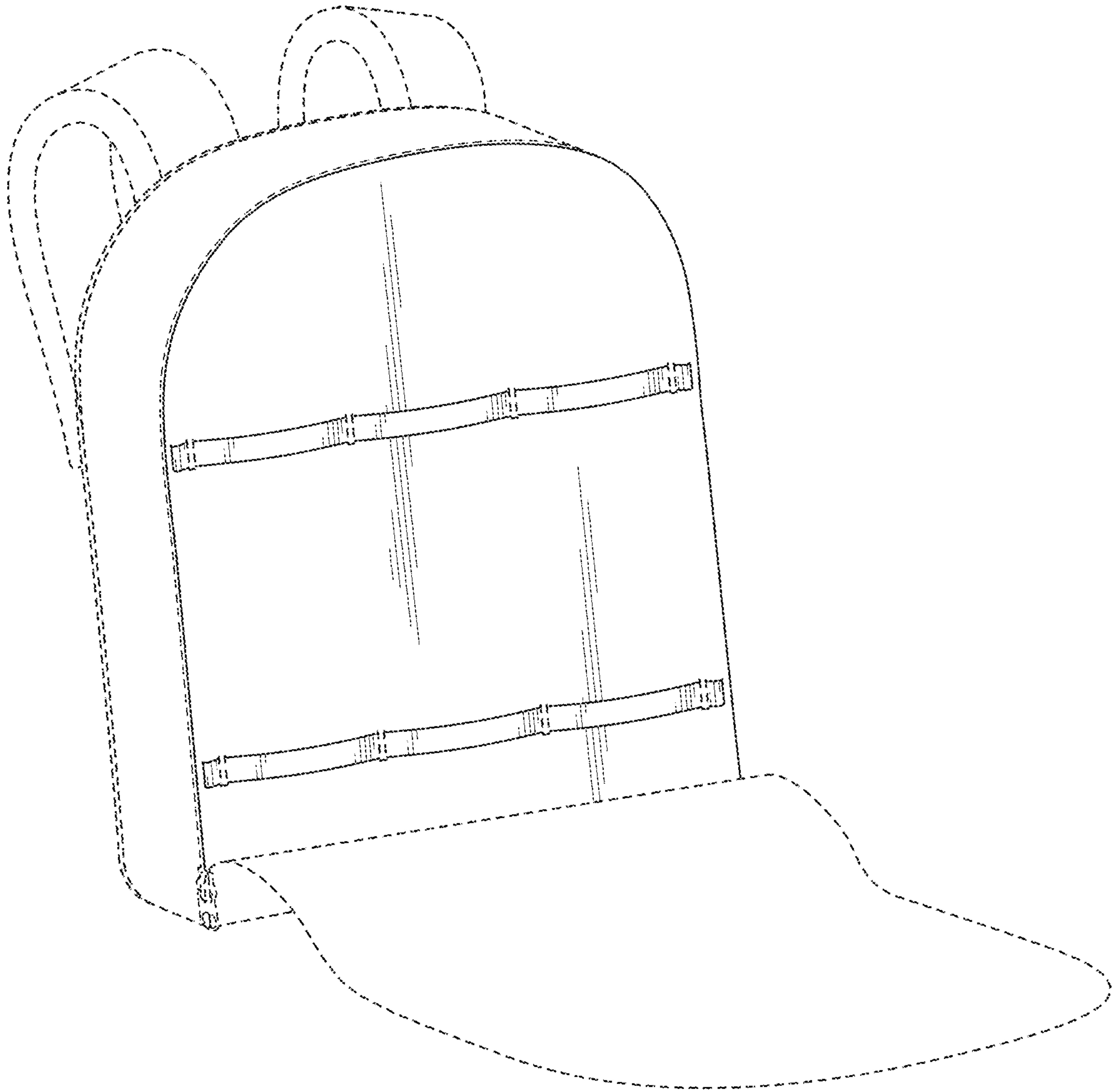

Fig. 57

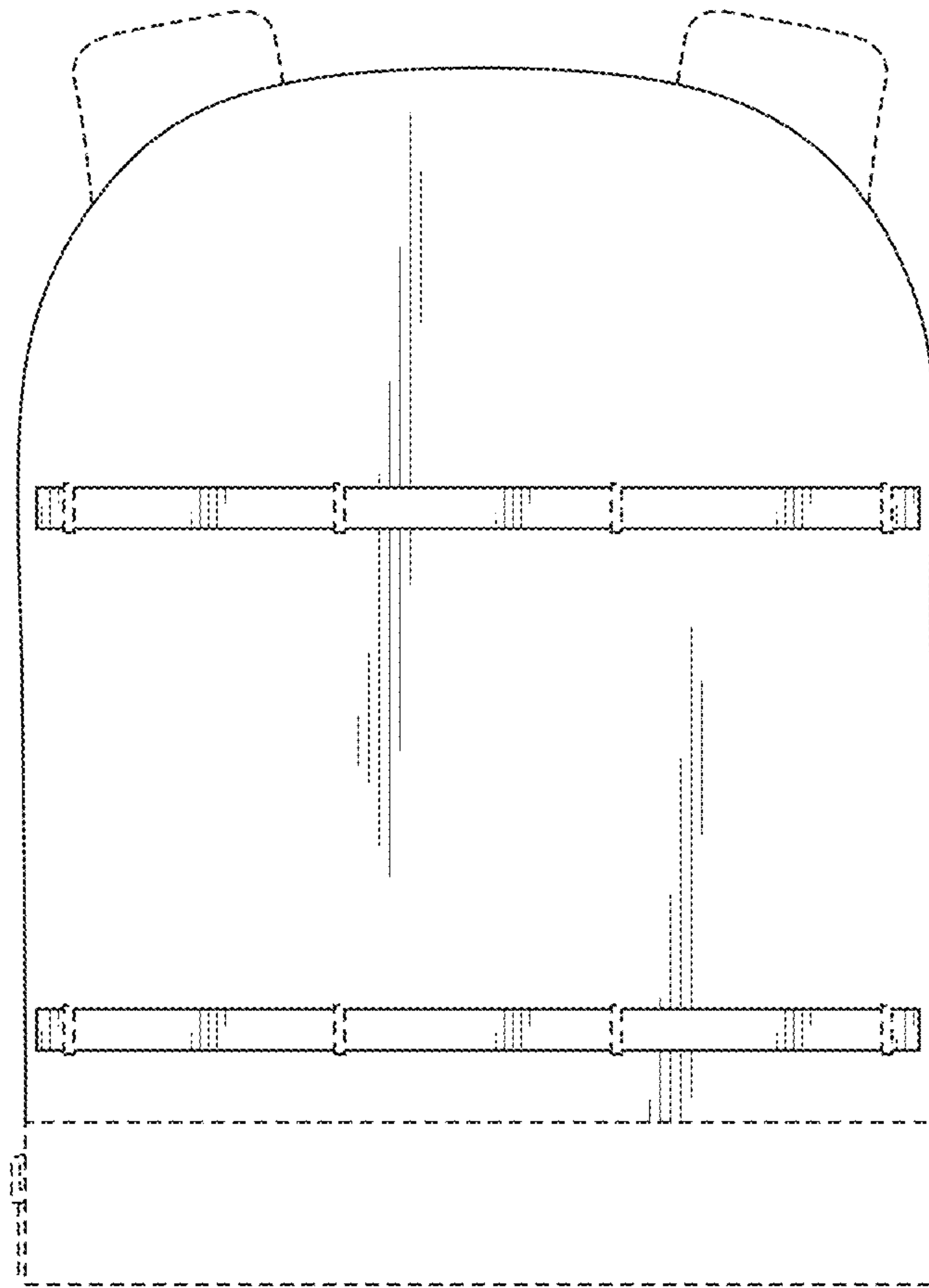

Fig. 58

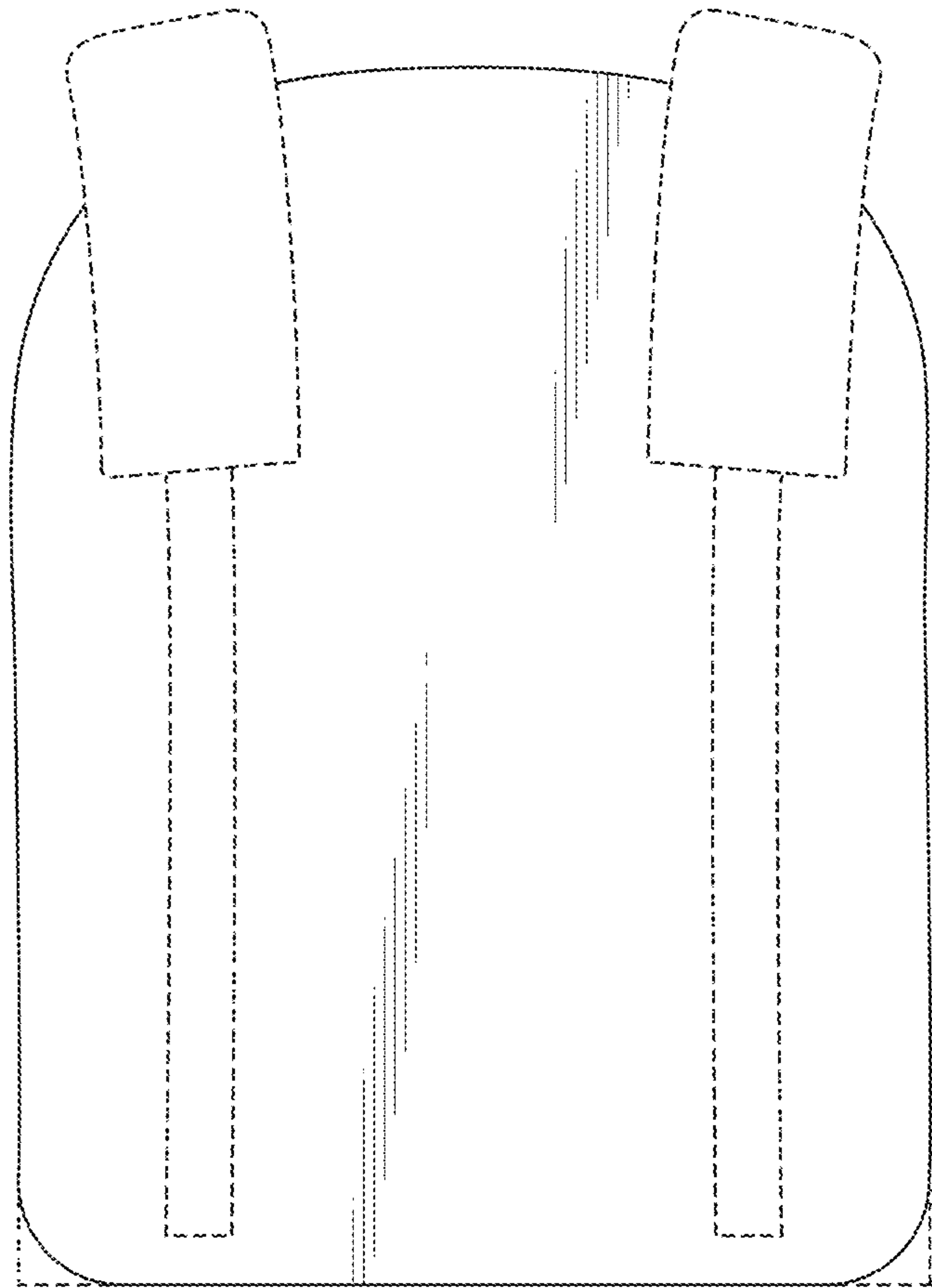

Fig. 59

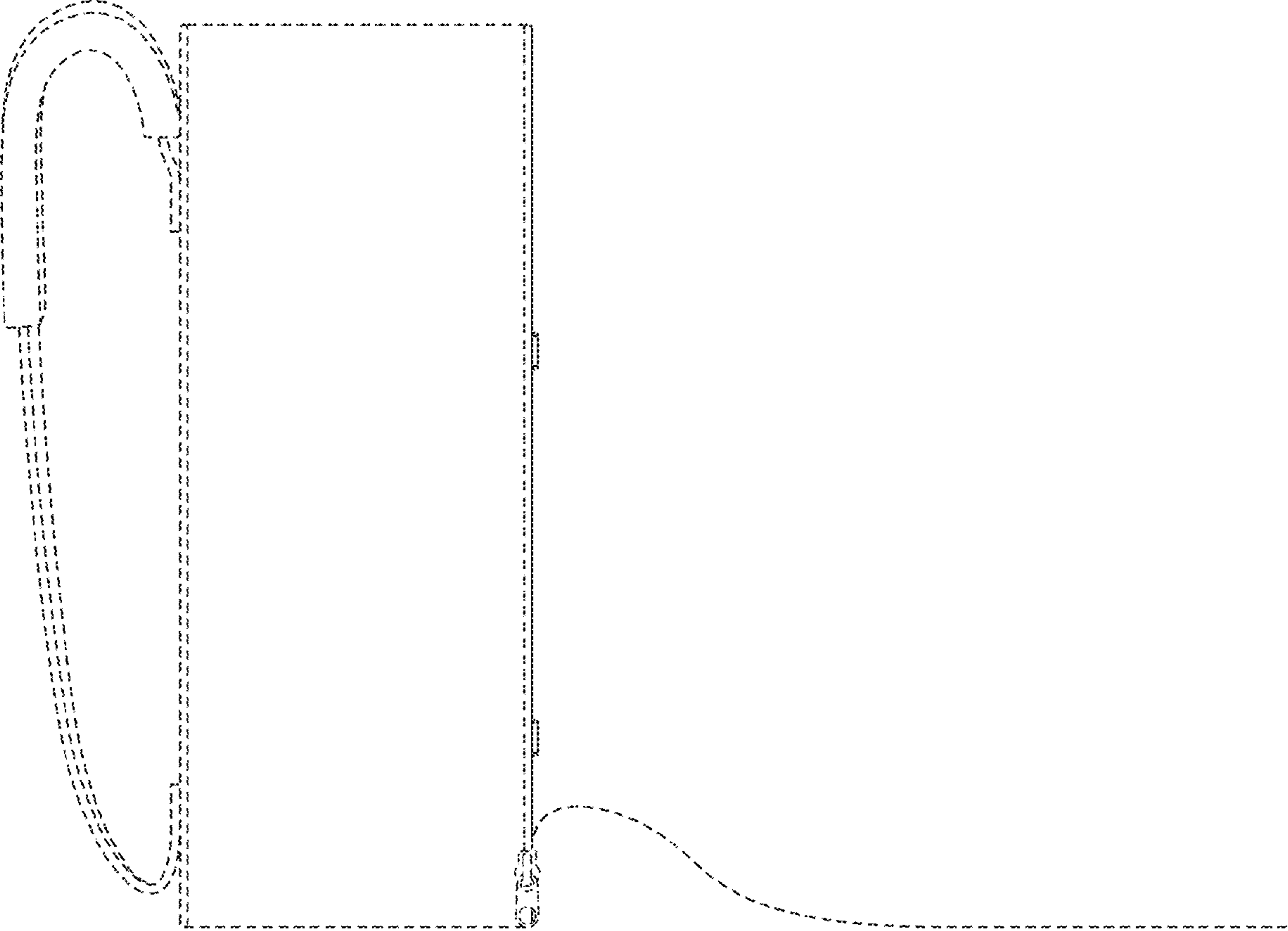

Fig. 60

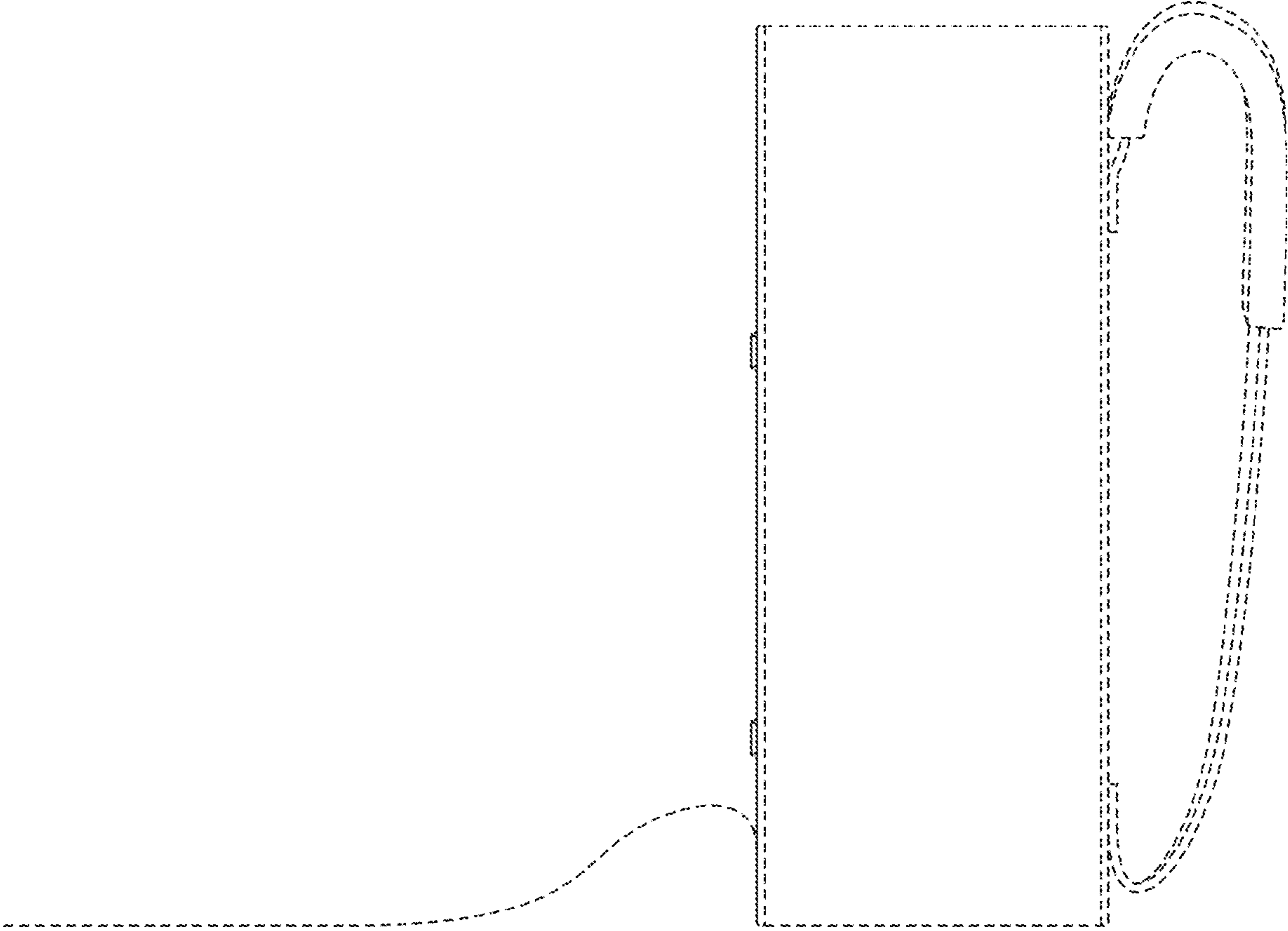

Fig. 61

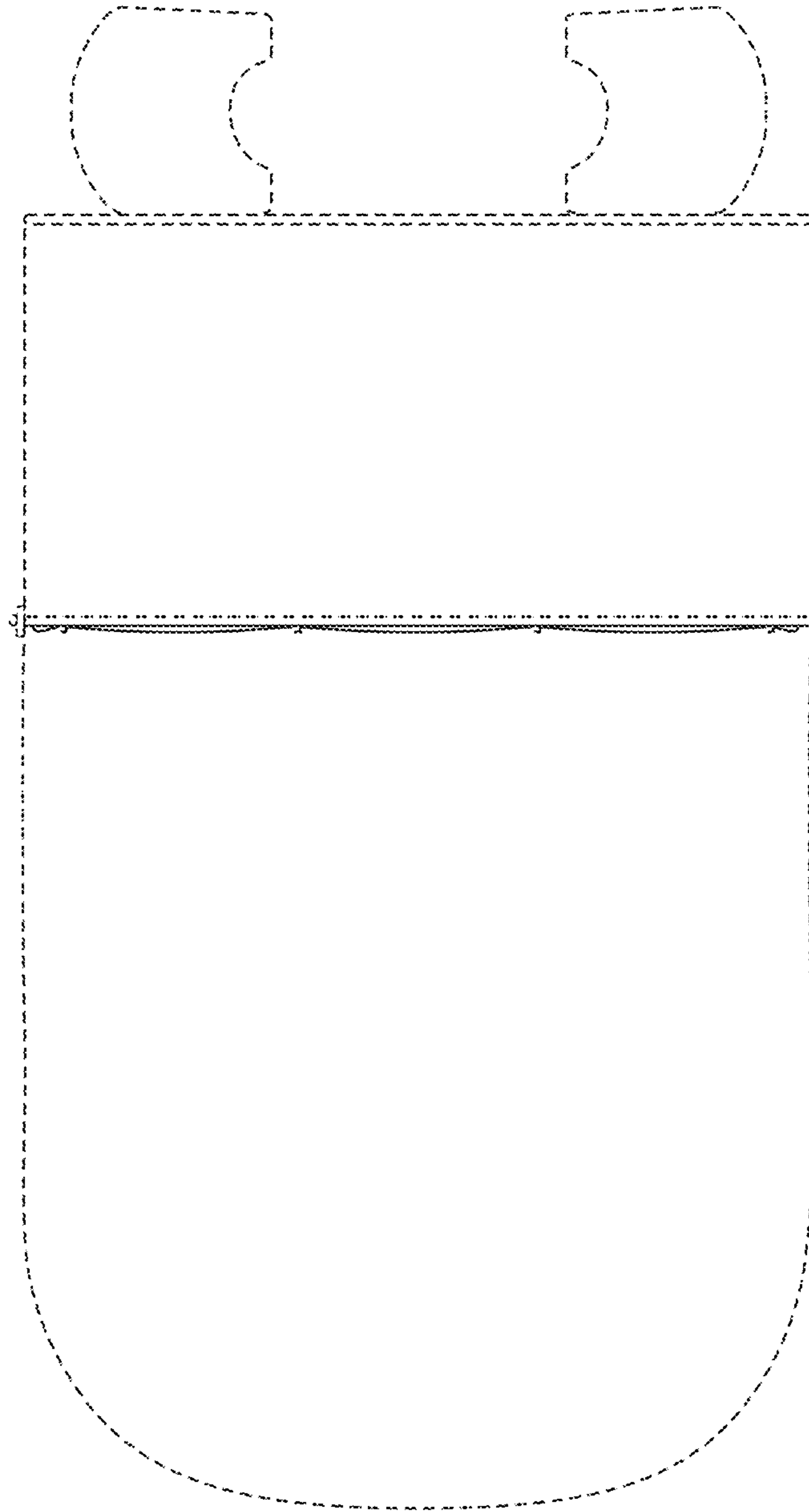

Fig. 62

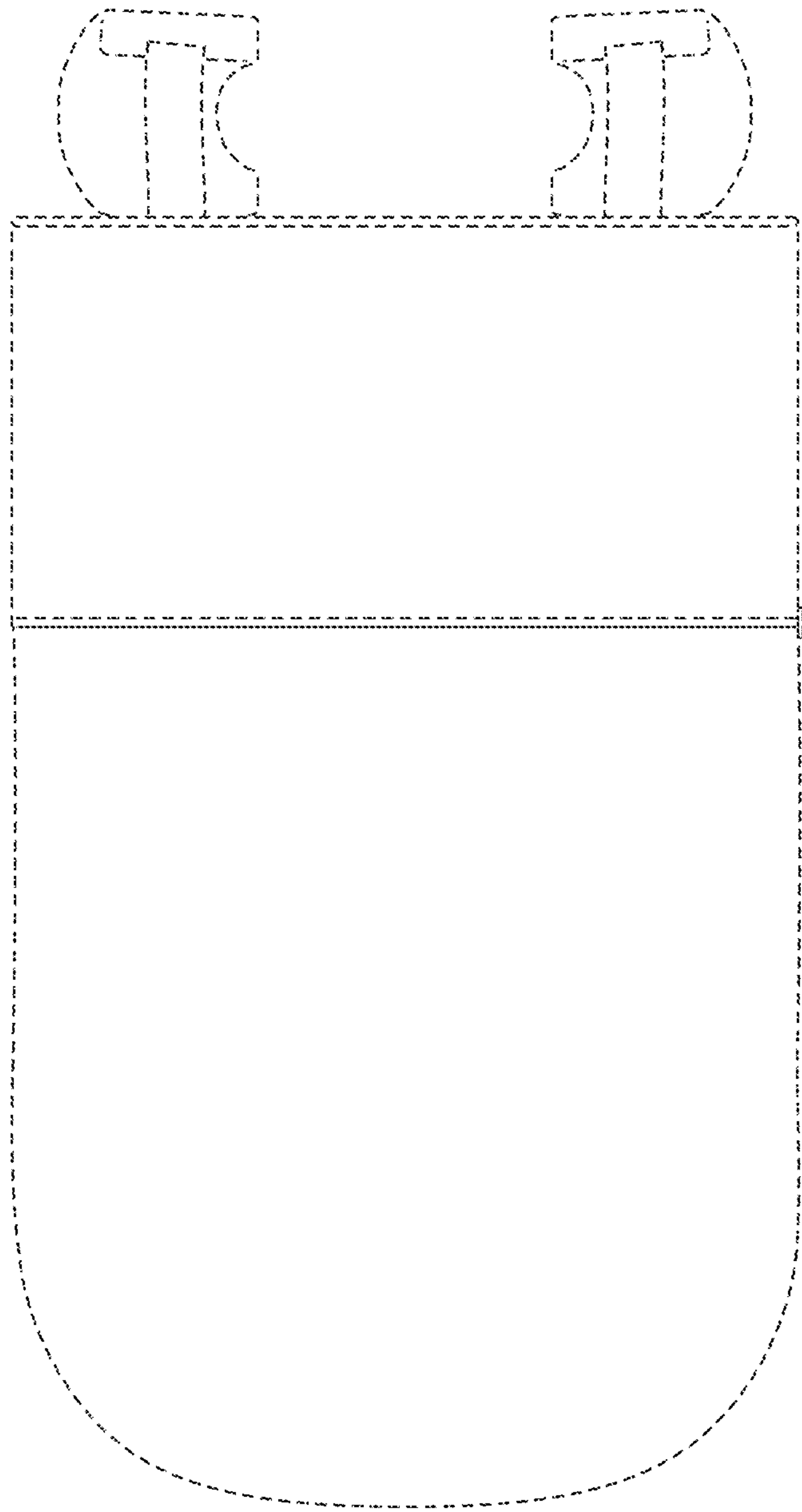

Fig. 63

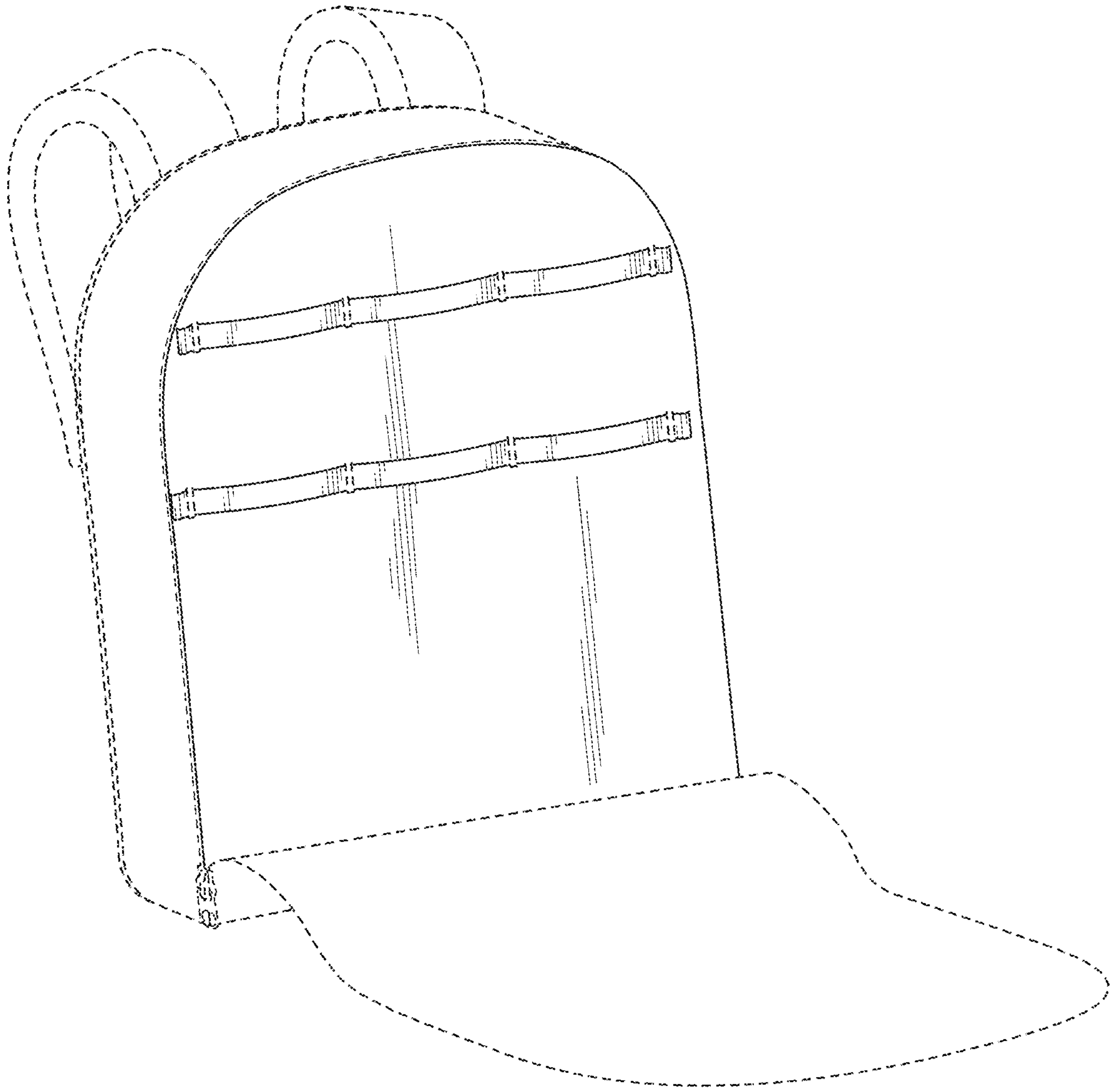

Fig. 64

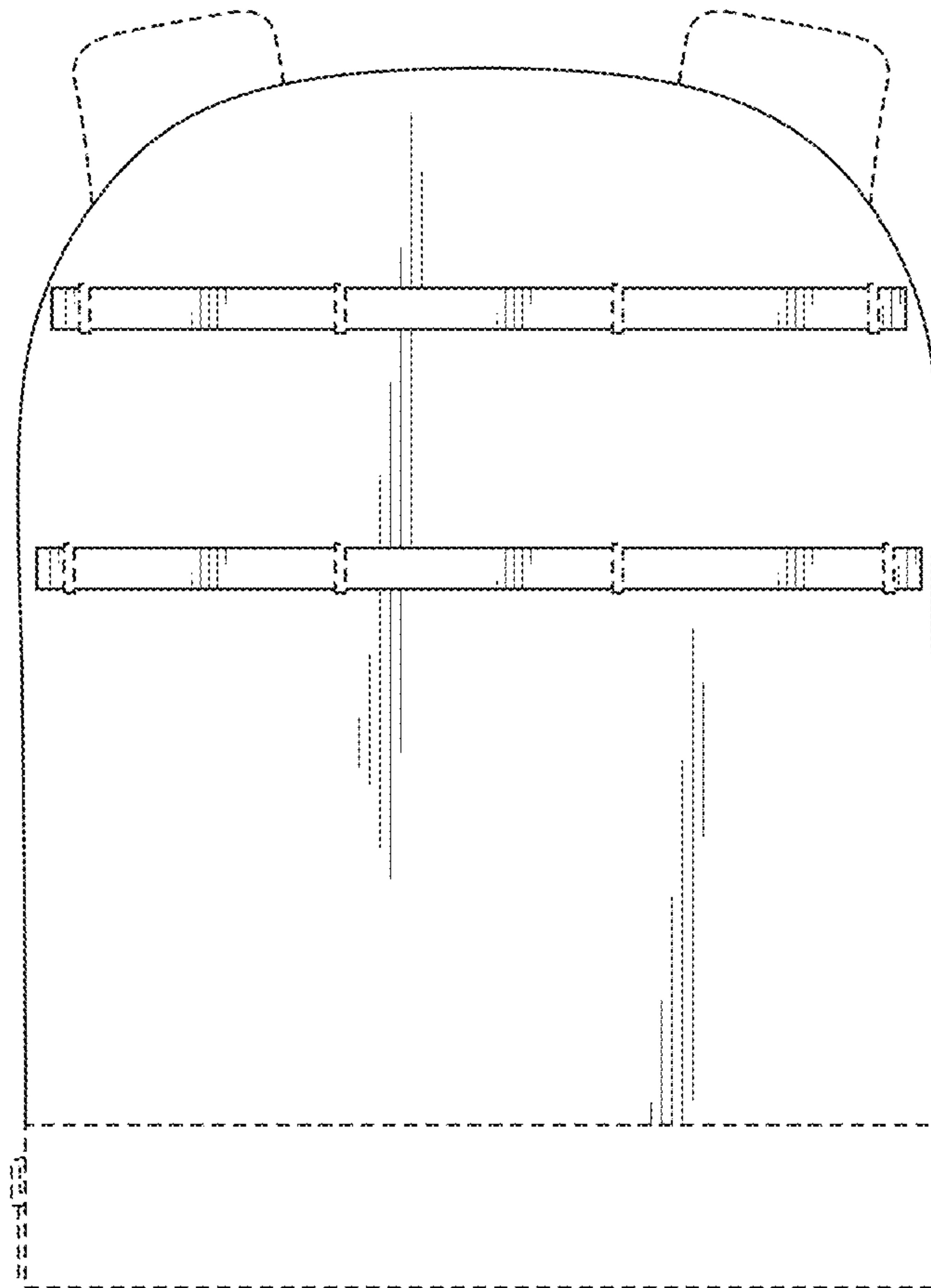

Fig. 65

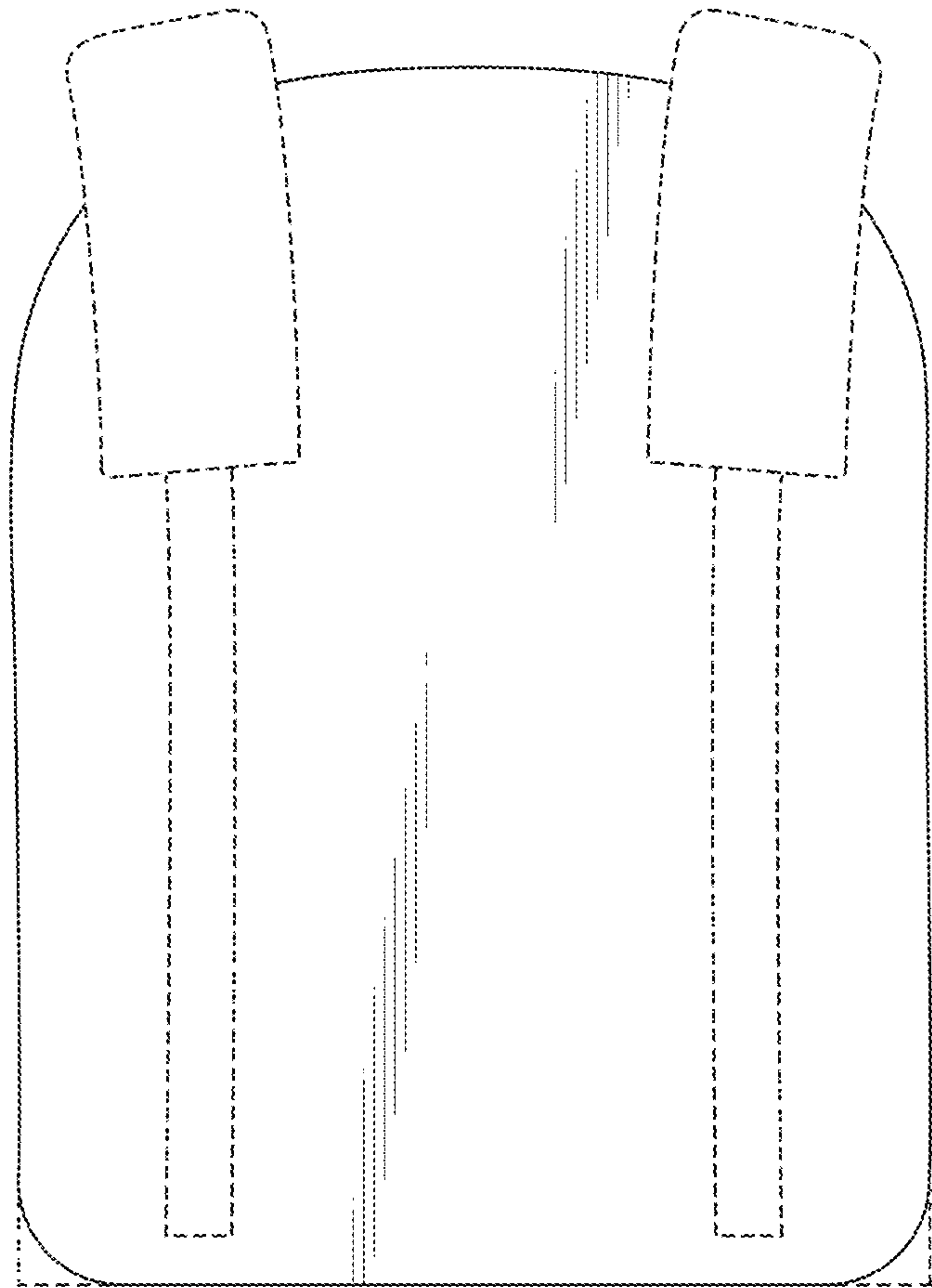

Fig. 66

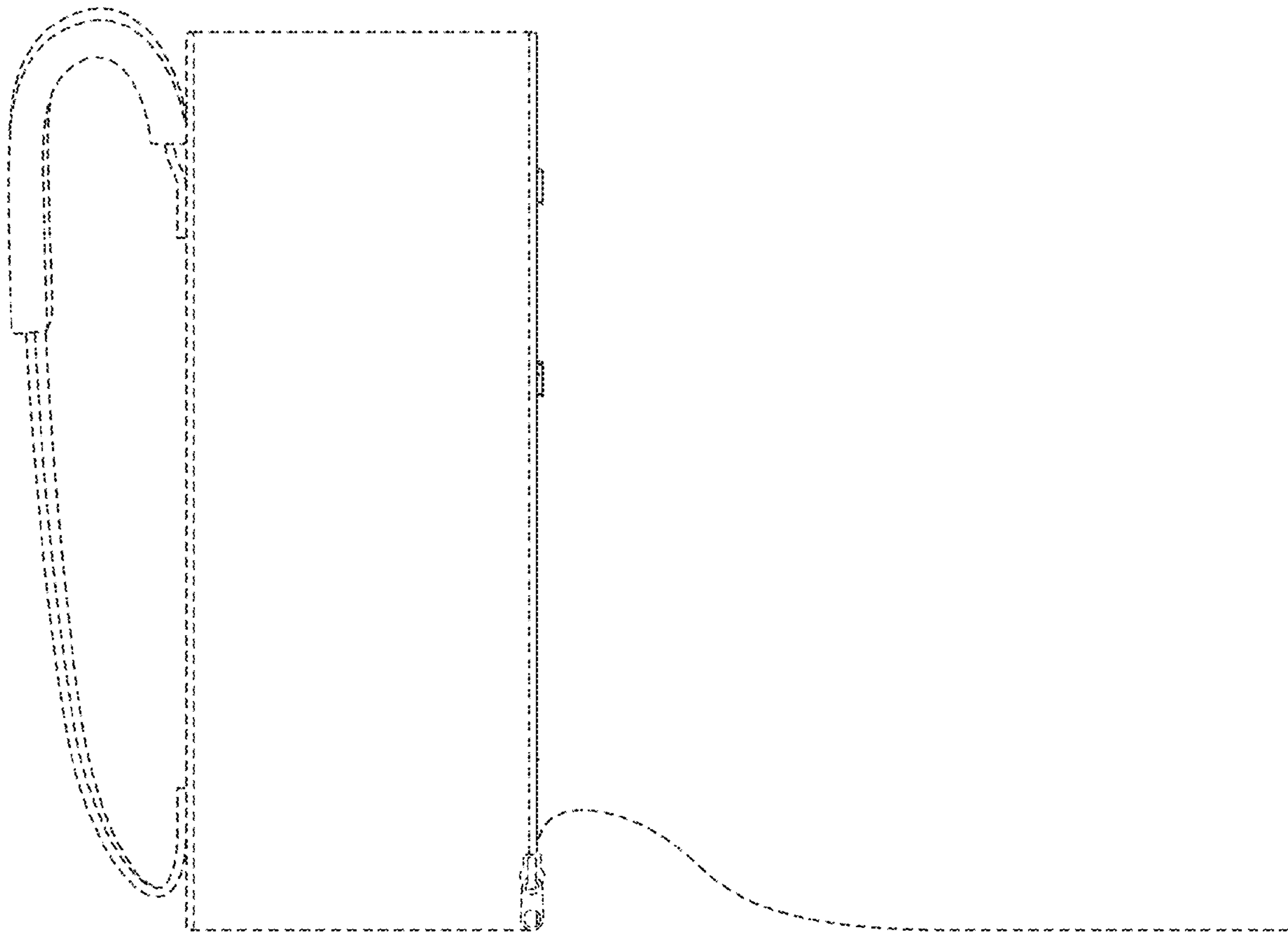

Fig. 67

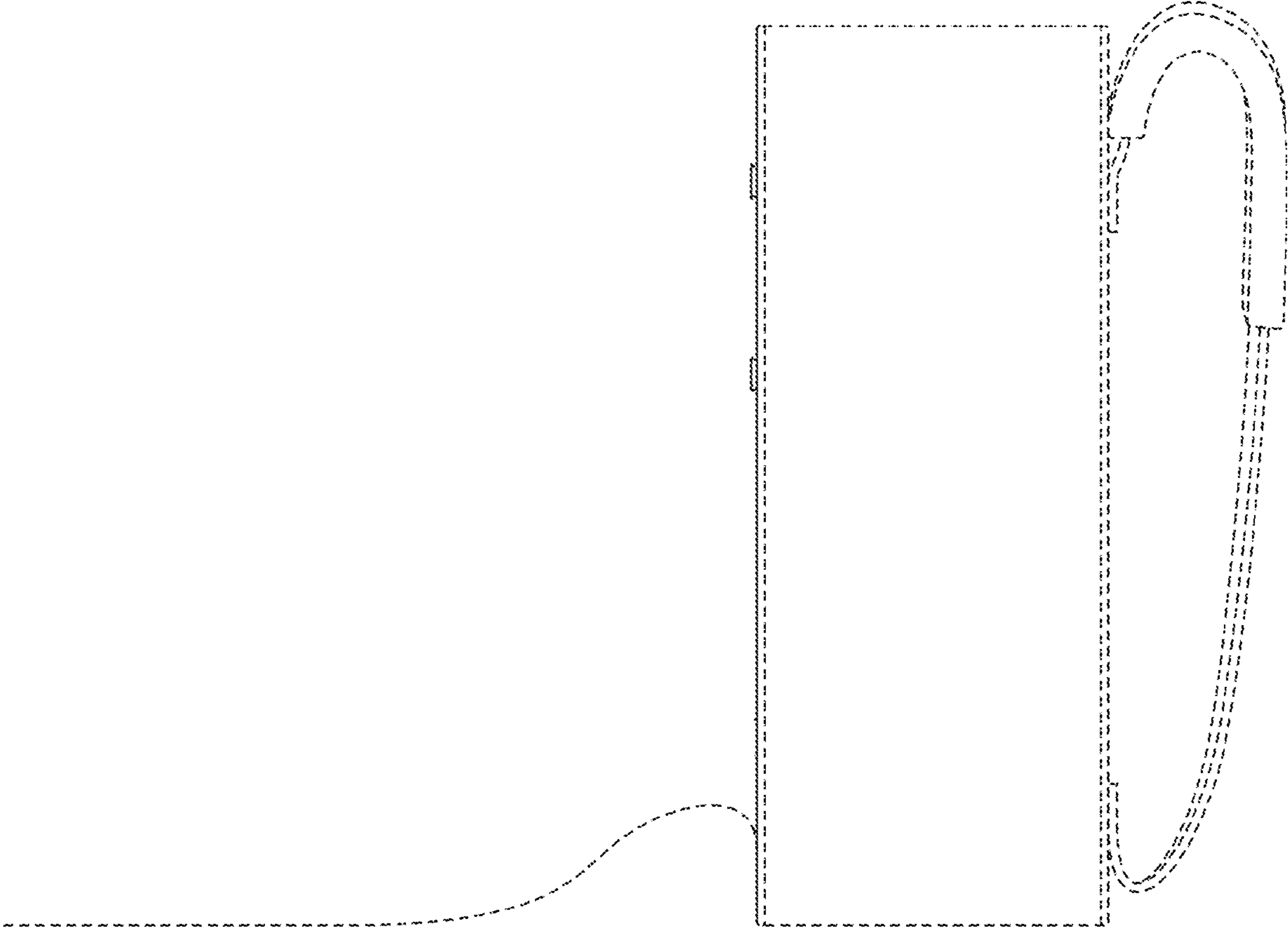

Fig. 68

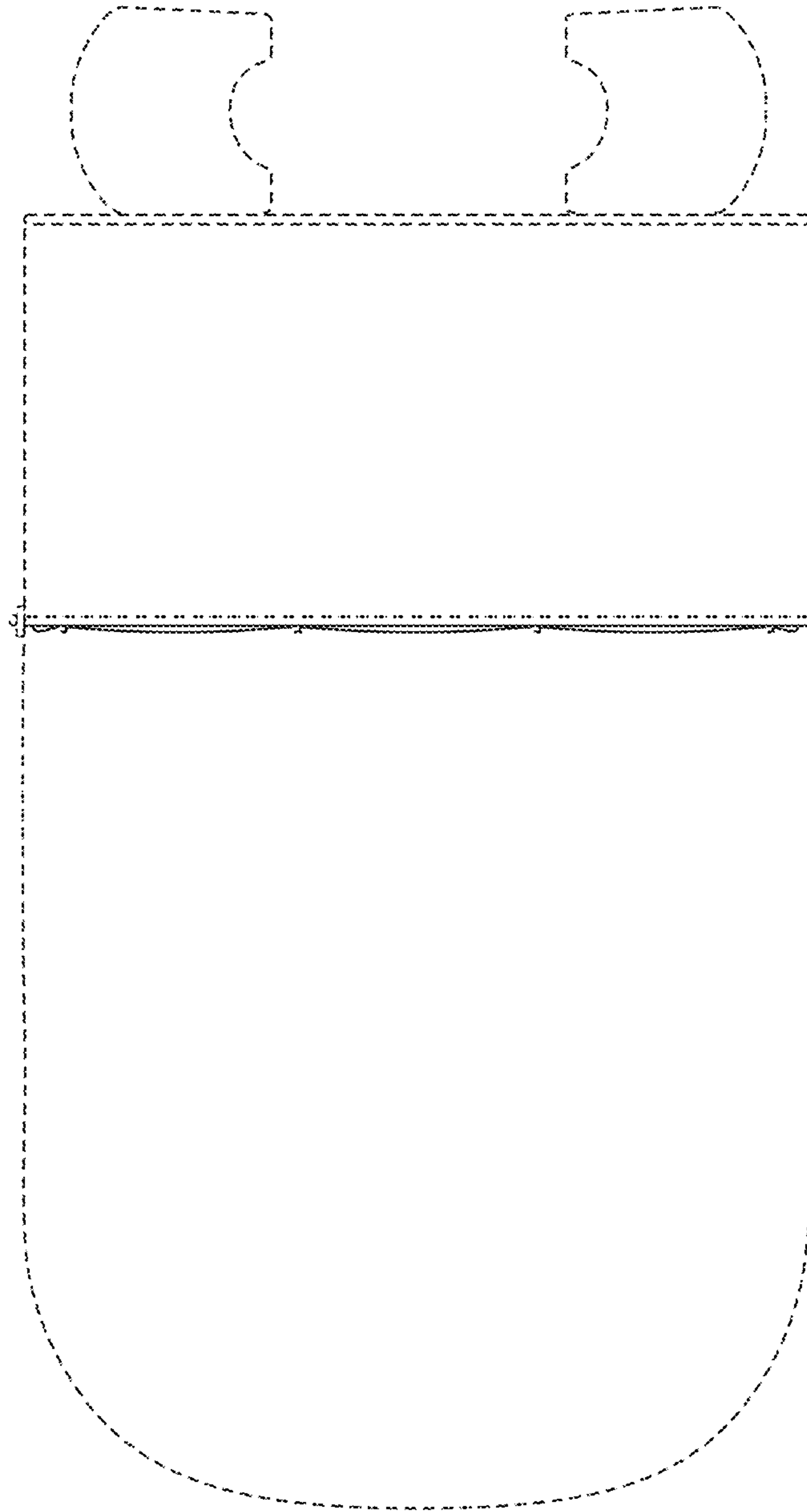

Fig. 69

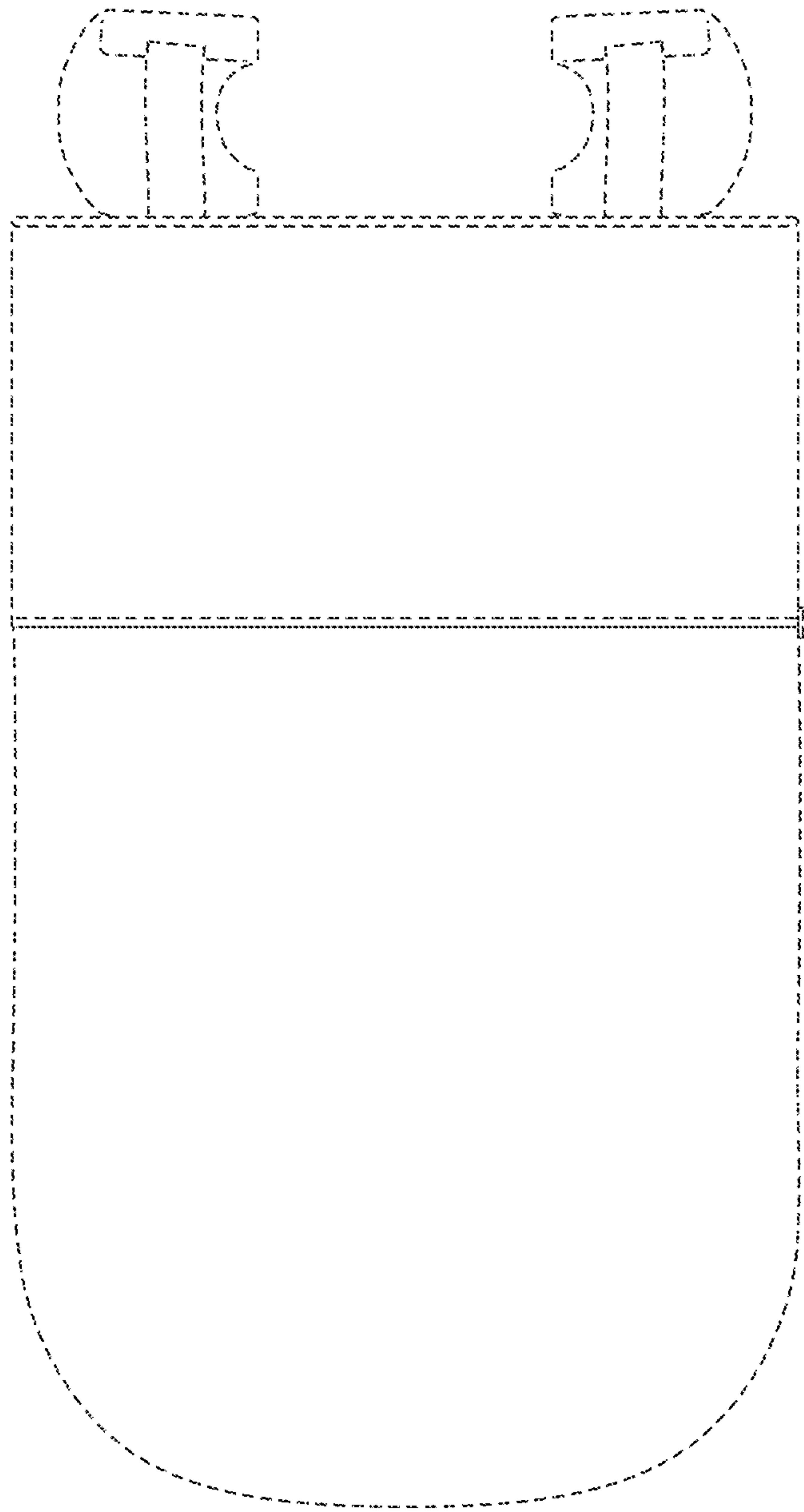

Fig. 70

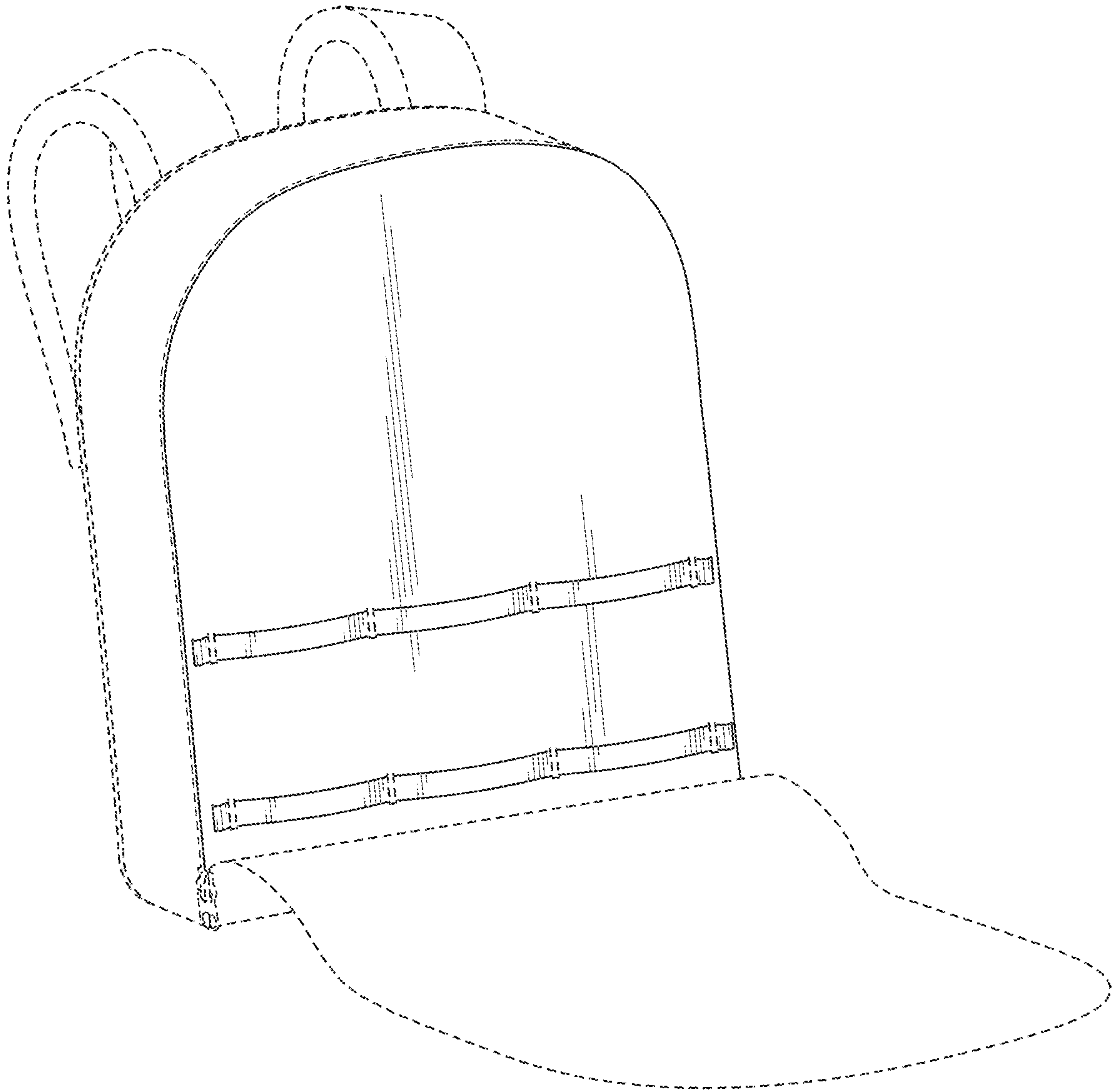

Fig. 71

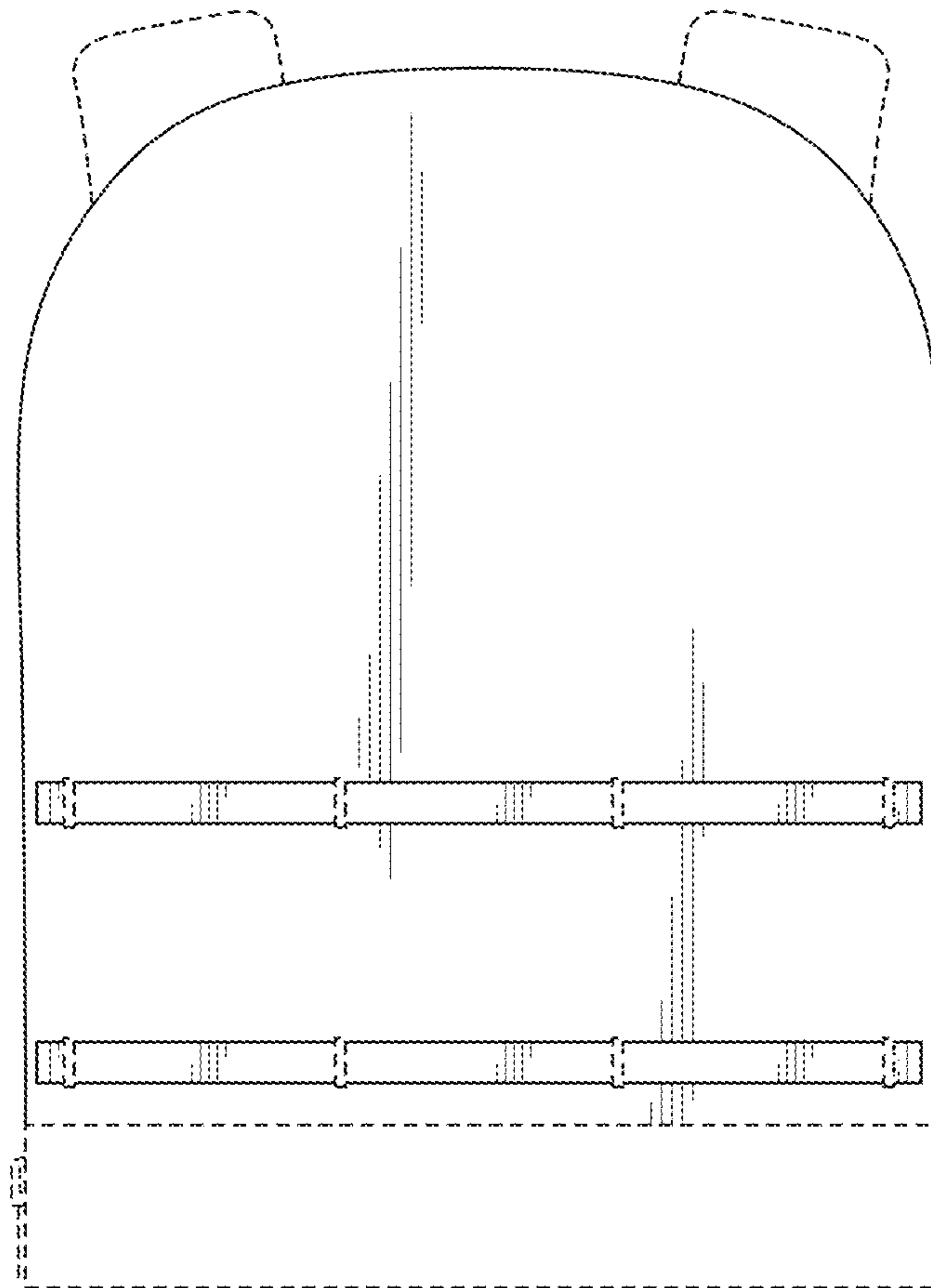

Fig. 72

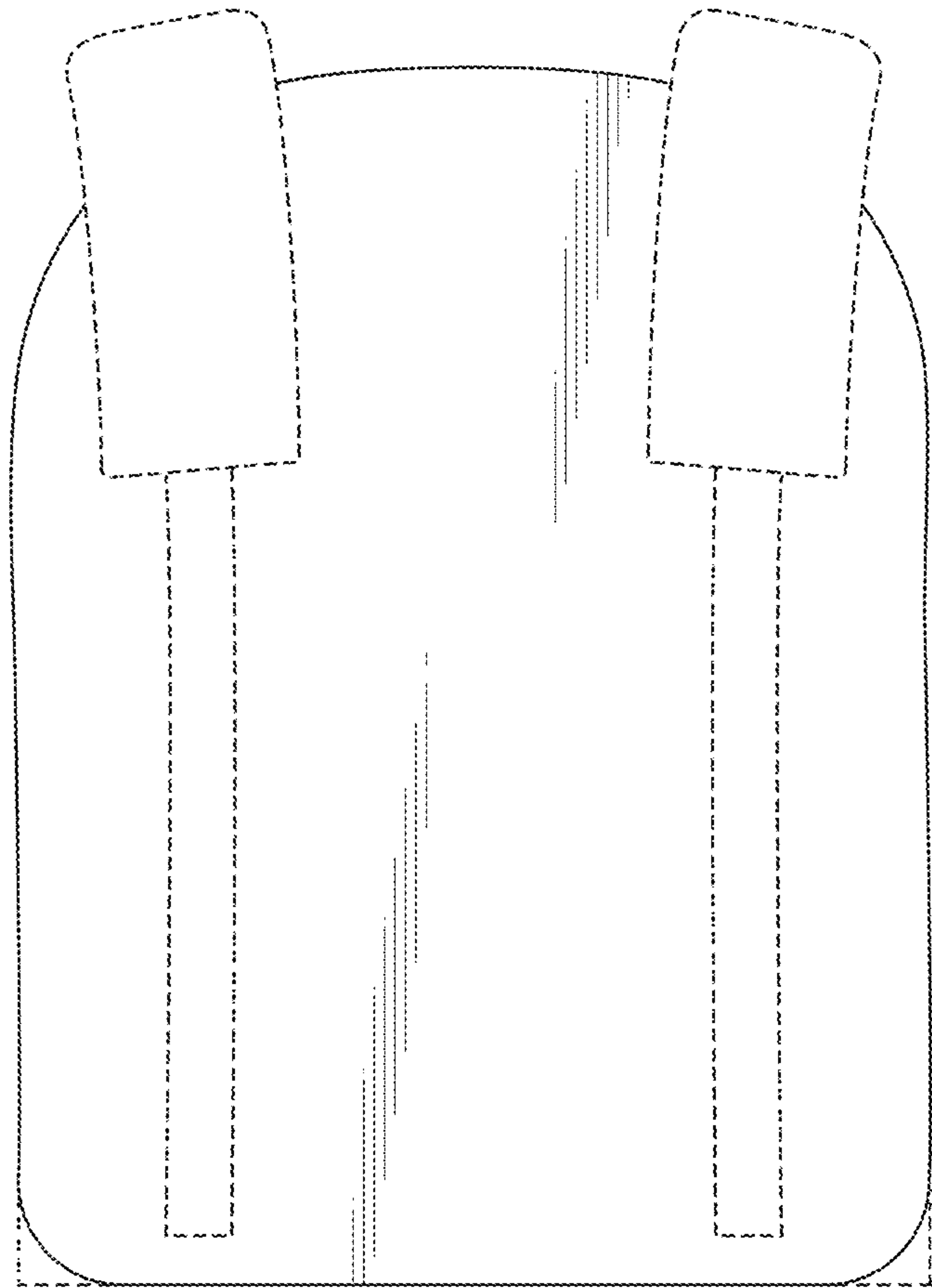

Fig. 73

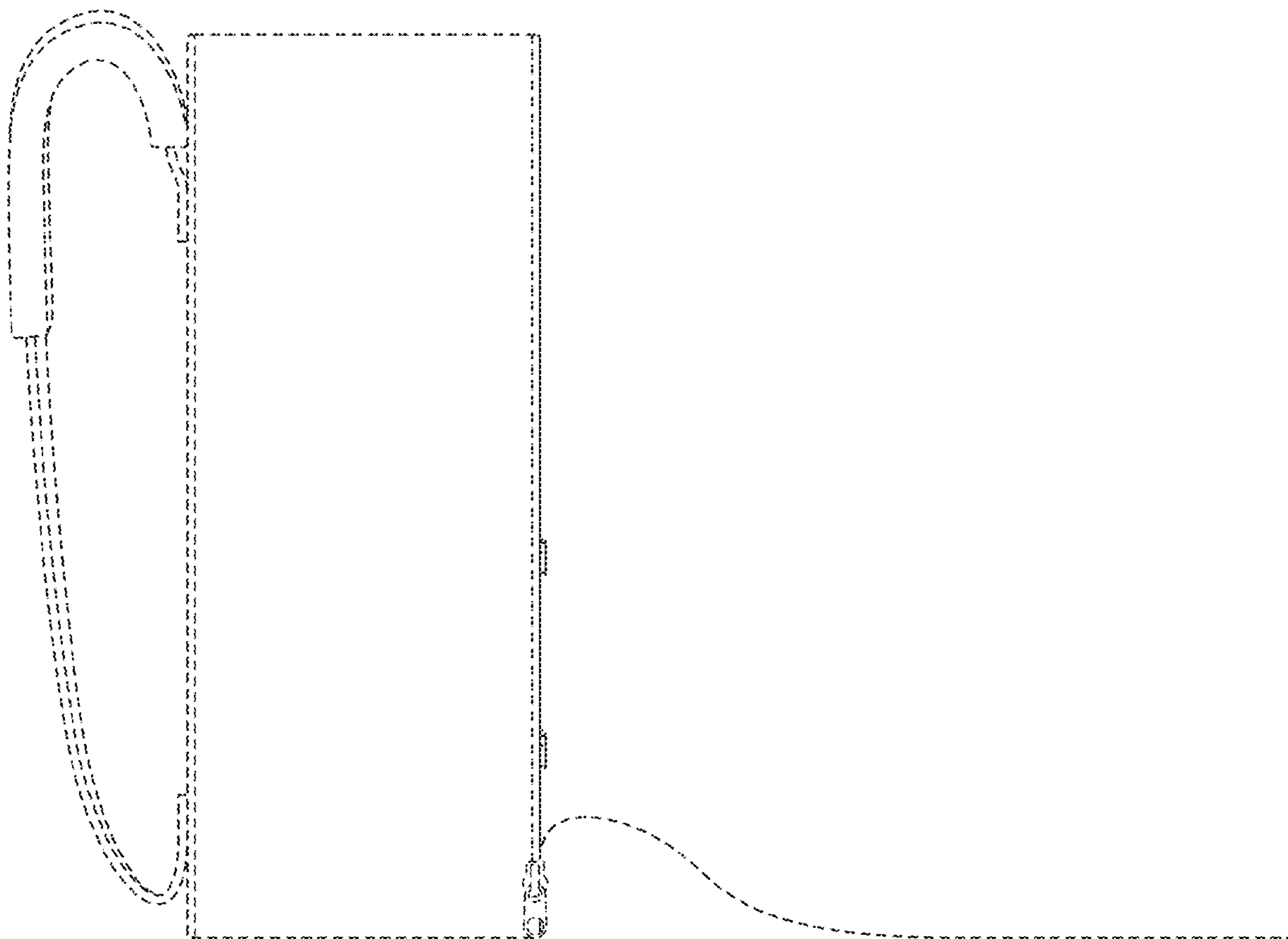

Fig. 74

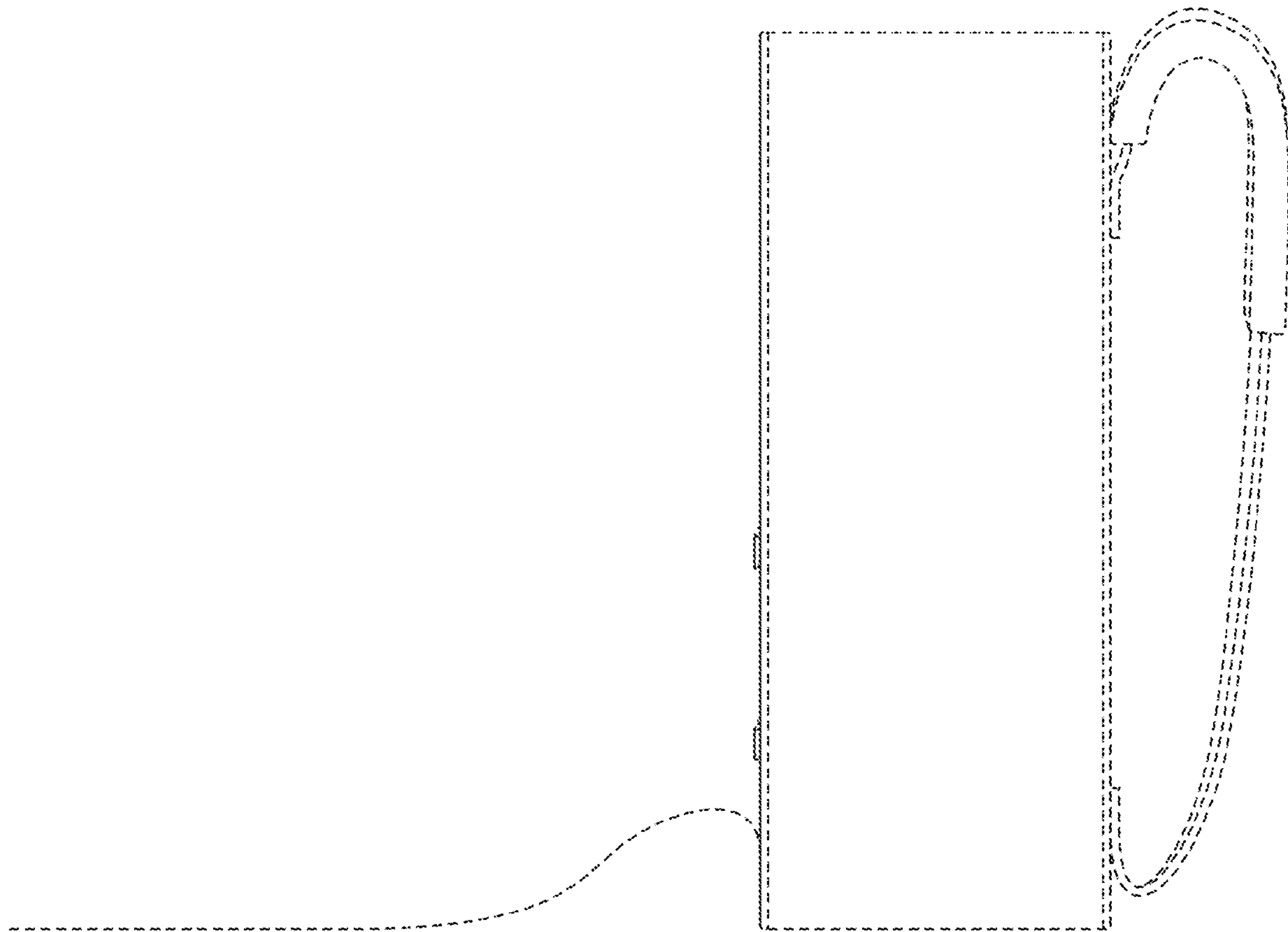

Fig. 75

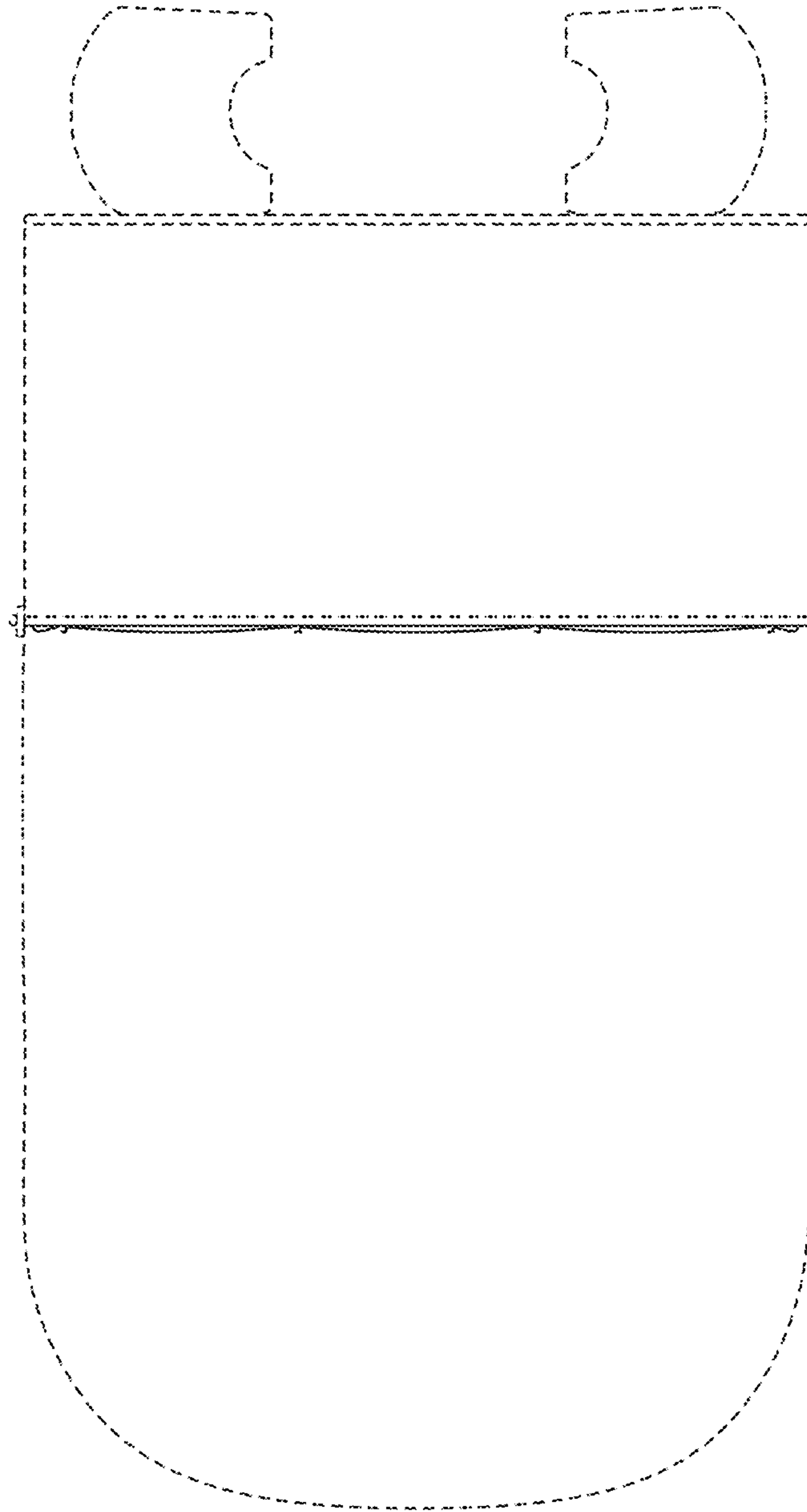

Fig. 76

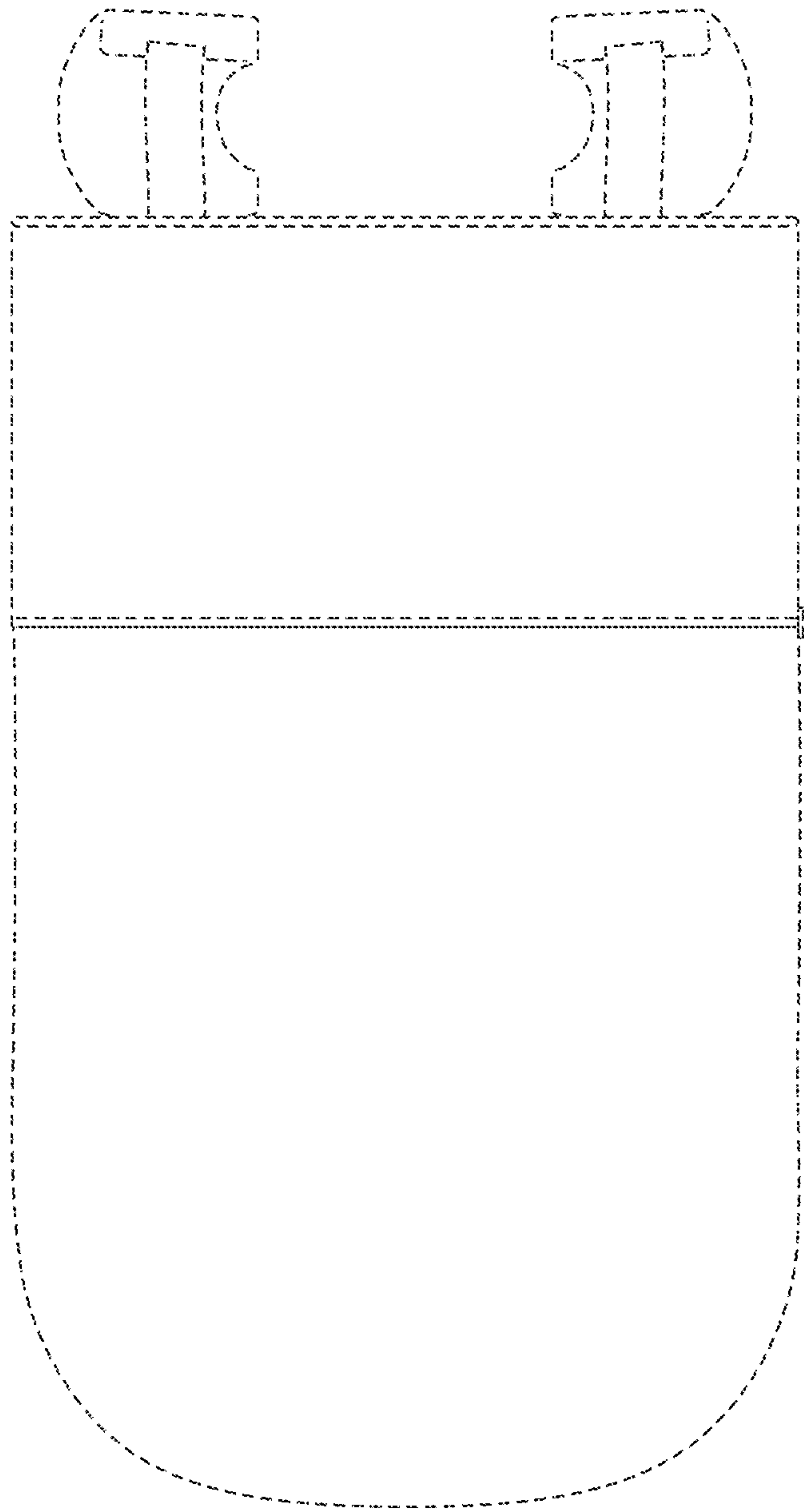

Fig. 77

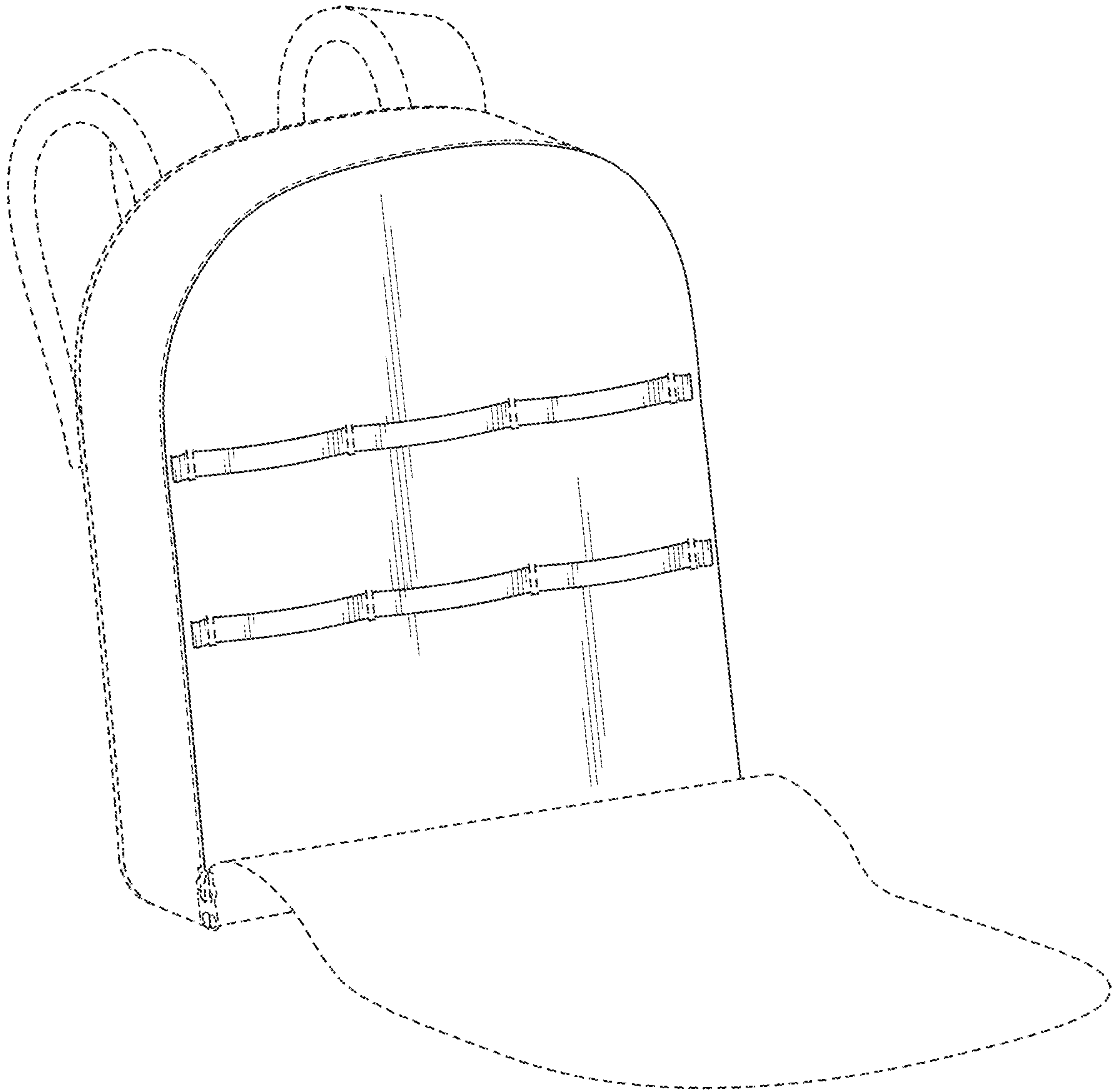

Fig. 78

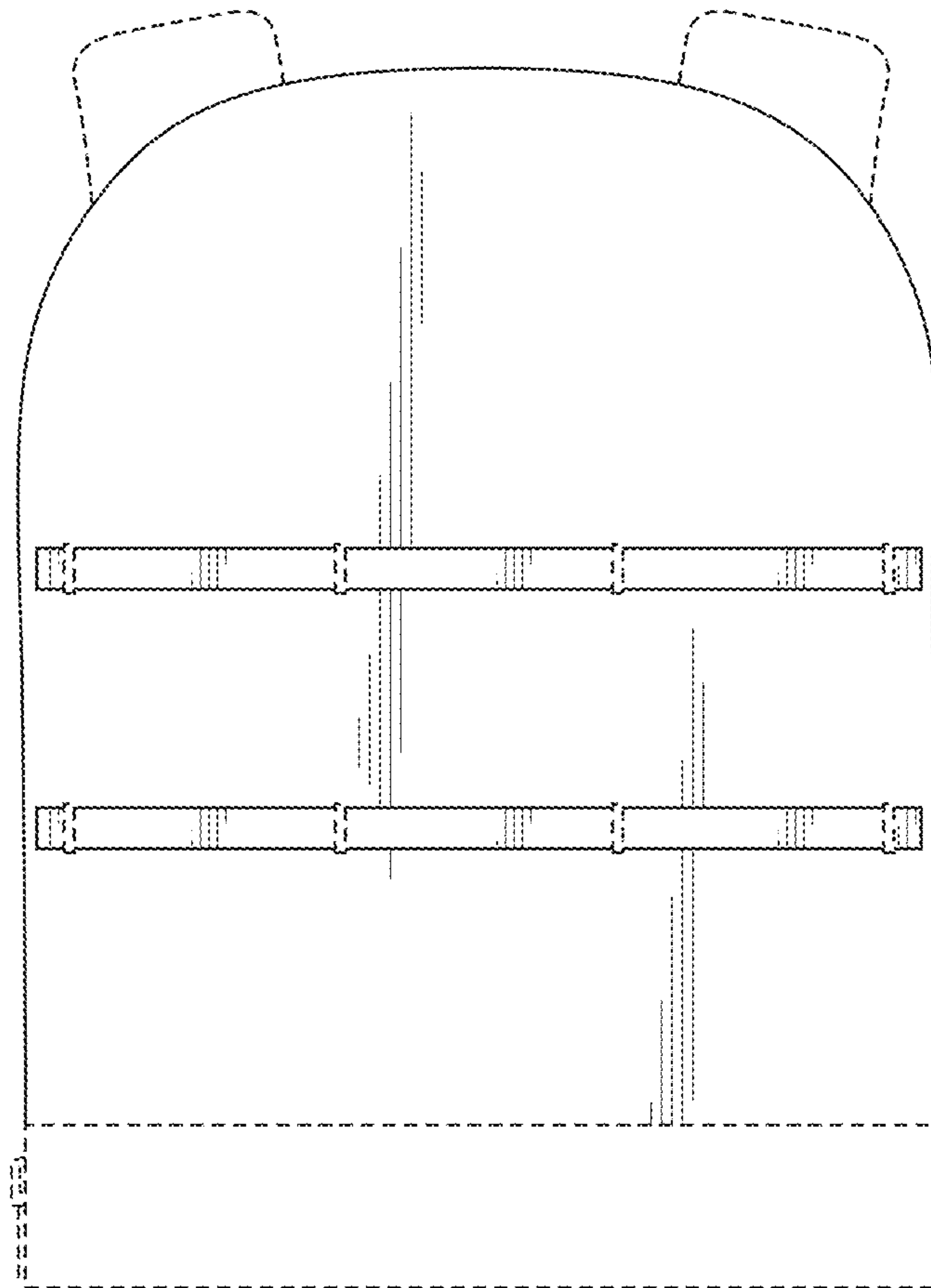

Fig. 79

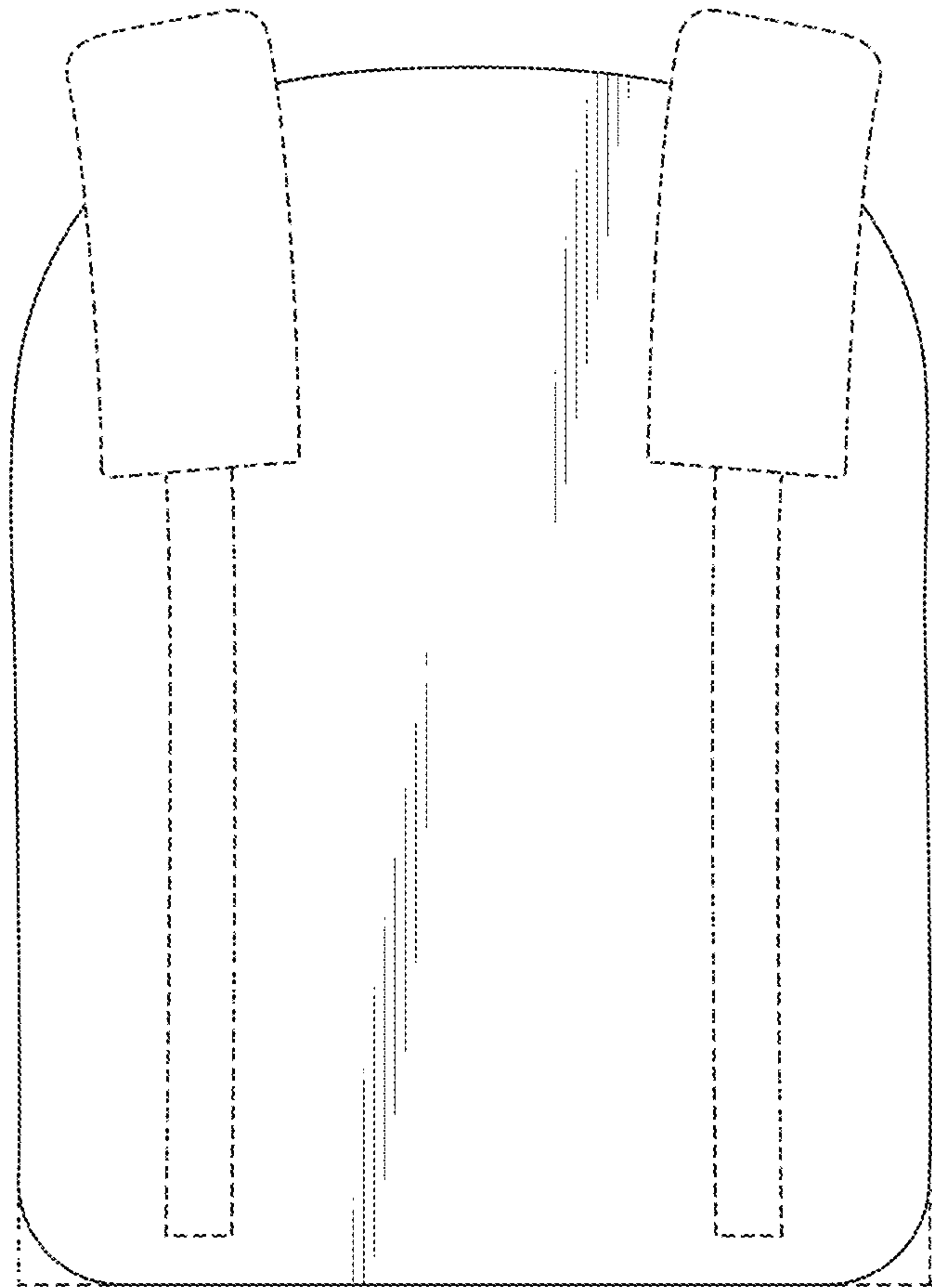

Fig. 80

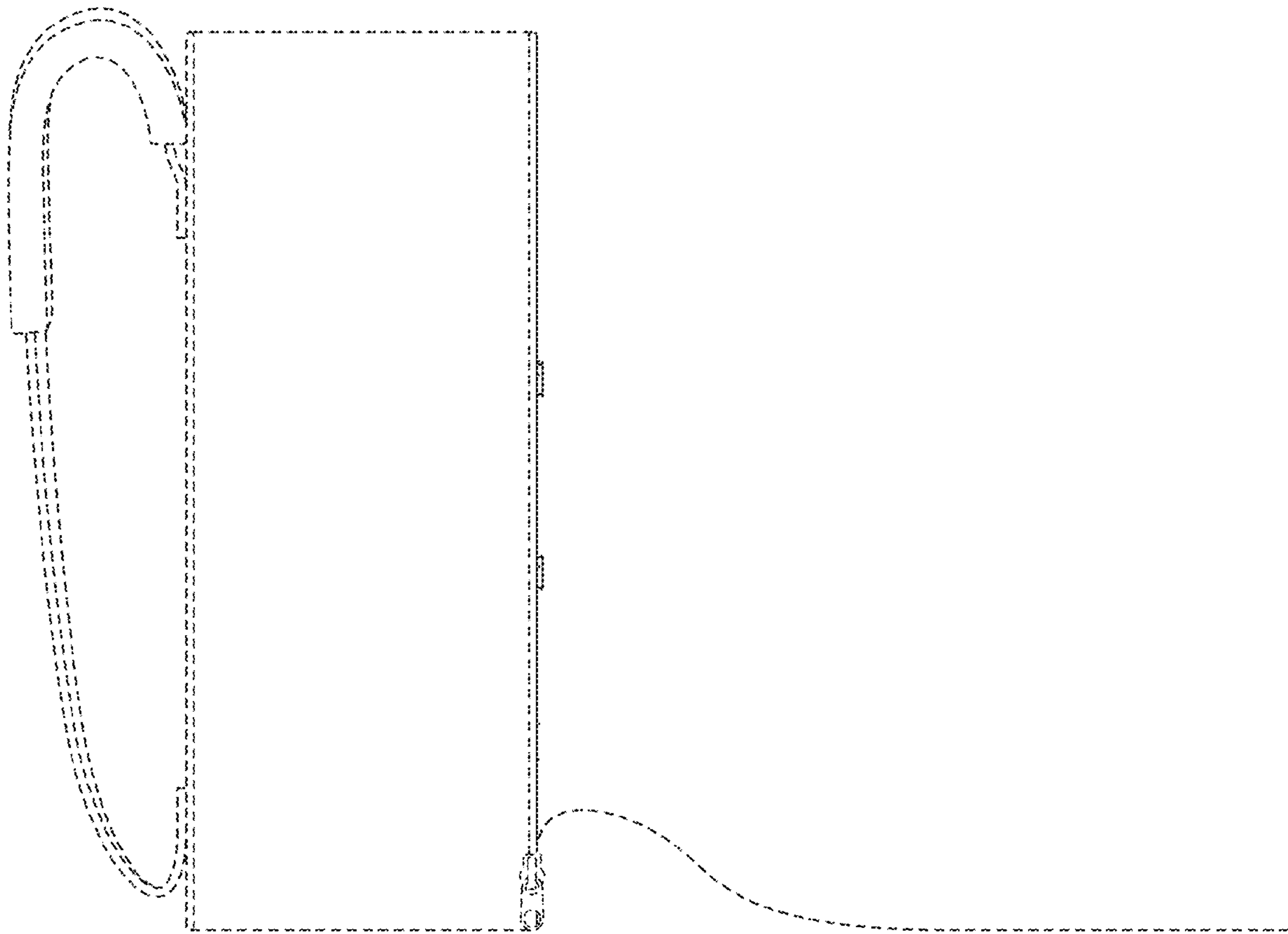

Fig. 81

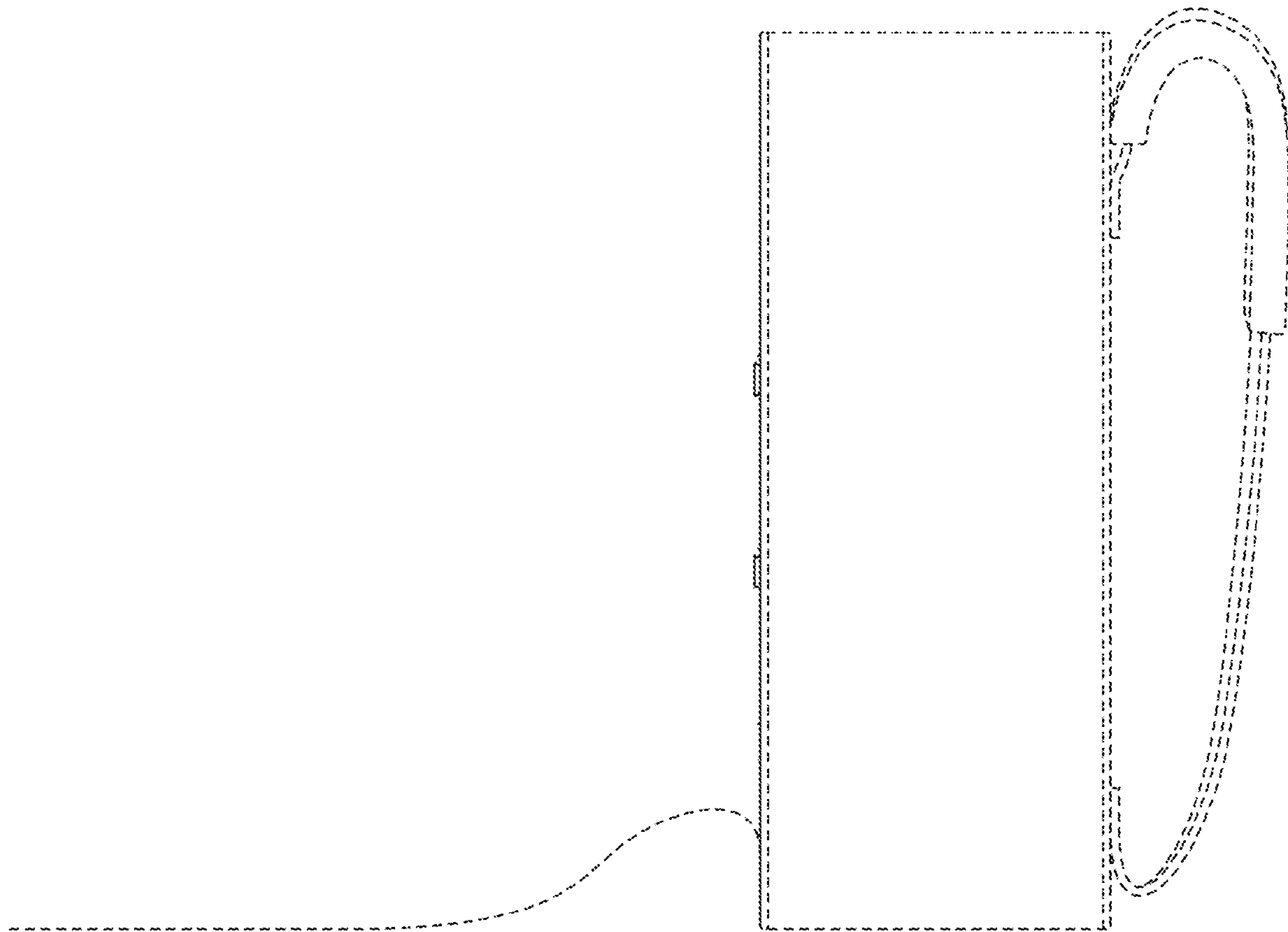

Fig. 82

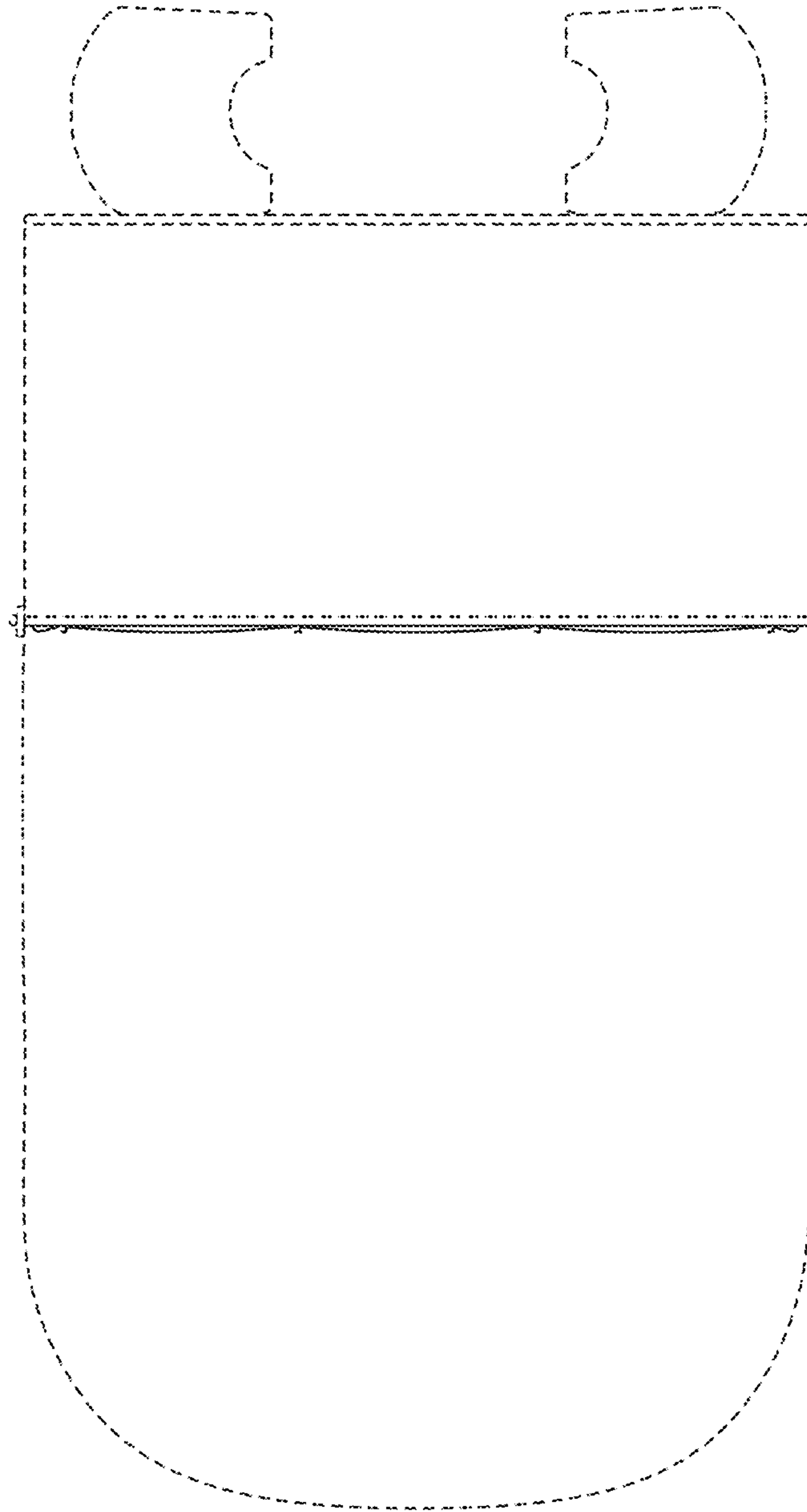

Fig. 83

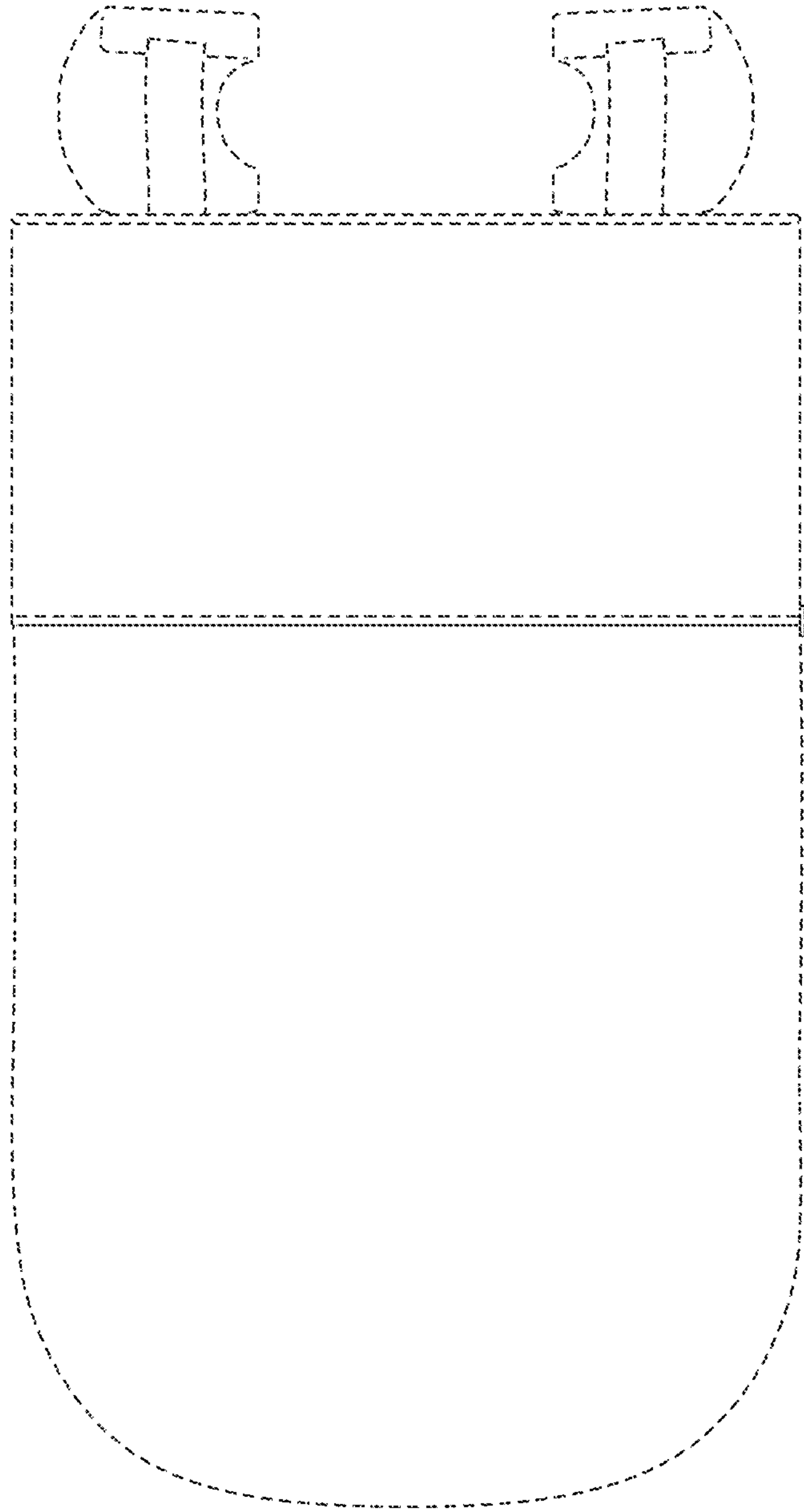

Fig. 84