



US00D899760S

(12) **United States Design Patent**
Kuang

(10) **Patent No.:** **US D899,760 S**

(45) **Date of Patent:** **** Oct. 27, 2020**

(54) **HEATED SOCK**

(71) Applicant: **Pinghua Kuang**, Nanchang (CN)

(72) Inventor: **Pinghua Kuang**, Nanchang (CN)

(**) Term: **15 Years**

(21) Appl. No.: **29/720,773**

(22) Filed: **Jan. 15, 2020**

(51) **LOC (12) Cl.** **02-04**

(52) **U.S. Cl.**
USPC **D2/980**

(58) **Field of Classification Search**
USPC D2/980-994; D24/192
CPC A61F 5/0111; A61F 5/0113; A61F 5/0127;
A41B 11/002

See application file for complete search history.

(56) **References Cited**

U.S. PATENT DOCUMENTS

D205,718 S *	9/1966	Nestler	D2/989
3,396,264 A *	8/1968	Murphy	A43B 3/0005
				219/211
D640,462 S *	6/2011	Daniel	D2/980
D726,404 S *	4/2015	Hoane	D2/994
D849,390 S *	5/2019	Abdul-Malik	D2/980
10,492,543 B2 *	12/2019	Parnell	A61F 7/032
2004/0254624 A1 *	12/2004	Johnson	A61N 1/0452
				607/149

OTHER PUBLICATIONS

“Vinmori Electric Heated Socks, Battery Heating Socks for Men Women Perfect for Hunting Hiking Shredding, Snowballs, Riding”, Retrieved Jan. 14, 2010]. Retrieved from Internet, <https://www.amazon.co.uk/Vinmori-Electric-Battery-Shredding-Snowballs/dp/B07Y9VPGD4/>.

* cited by examiner

Primary Examiner — Jennifer L Watkins

(57) **CLAIM**

The ornamental design for a heated sock, as shown and described.

DESCRIPTION

FIG. 1 is an exploded view of a heated sock showing my new design;

FIG. 2 is a front elevational view thereof;

FIG. 3 is a rear elevational view thereof;

FIG. 4 is a right side elevational view thereof;

FIG. 5 is a left side elevational view thereof;

FIG. 6 is a top plan view thereof; and,

FIG. 7 is a bottom plan view thereof.

The broken lines in the drawings depict portions of the heated sock that form no part of the claimed design.

1 Claim, 7 Drawing Sheets

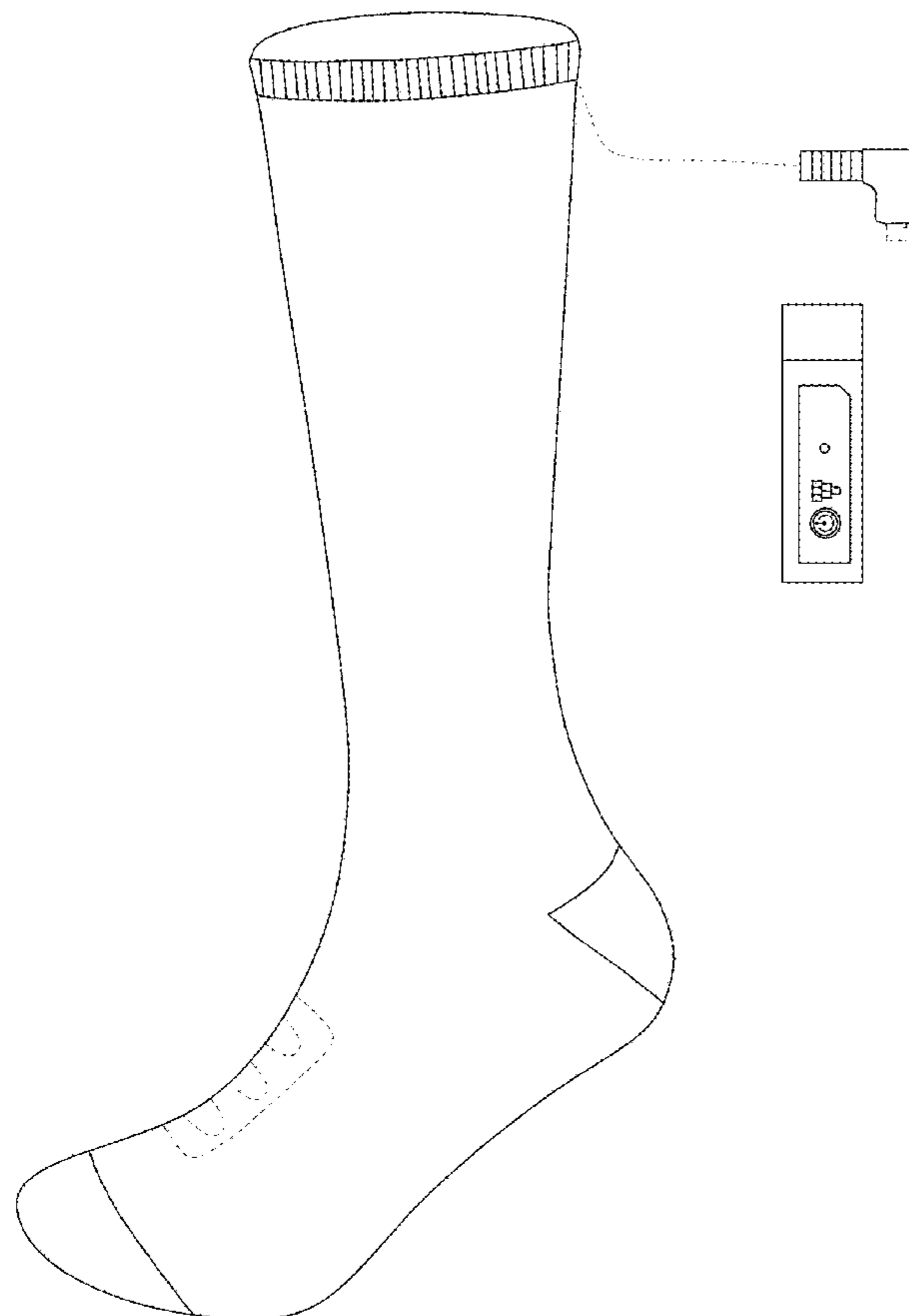

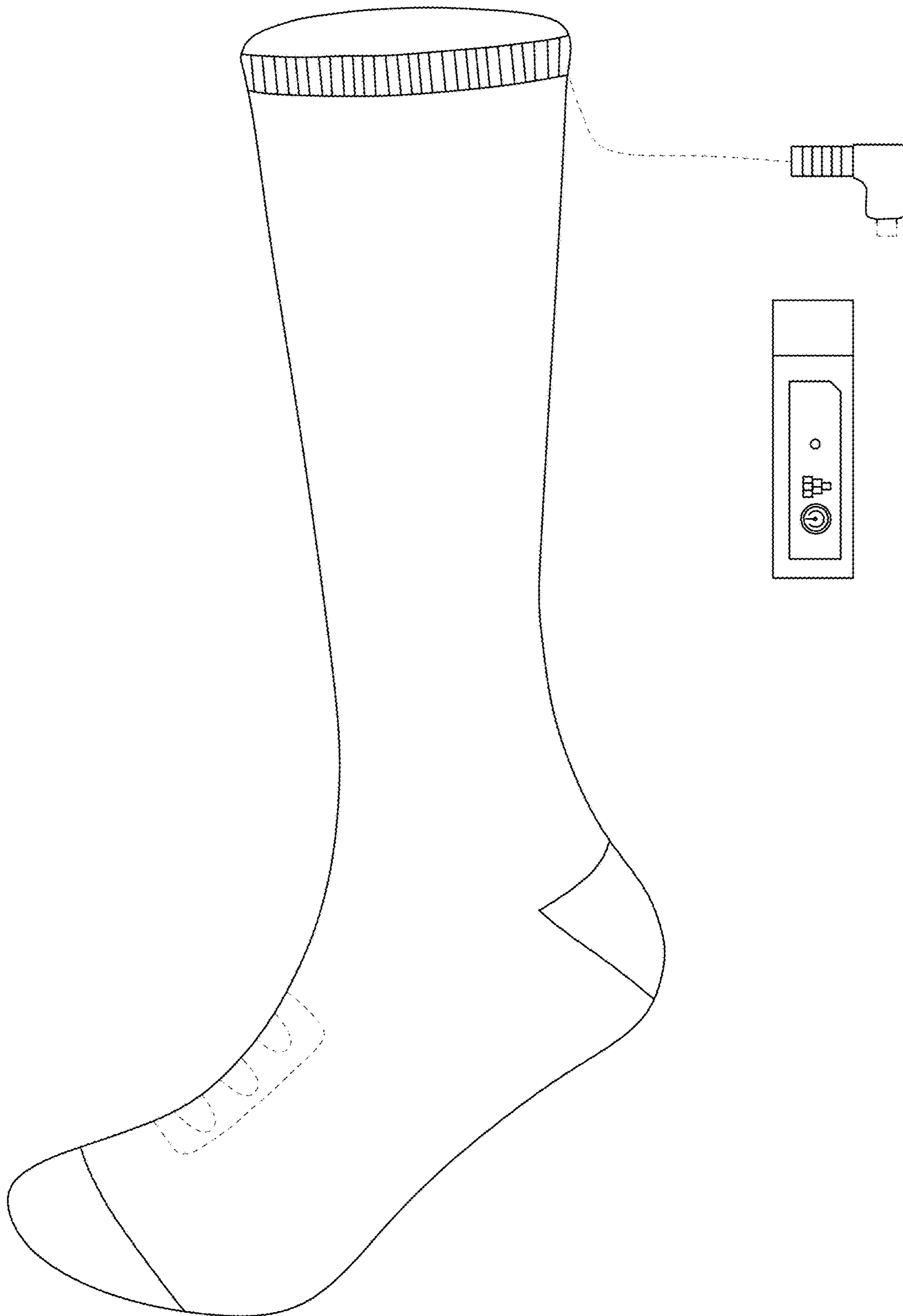

FIG. 1

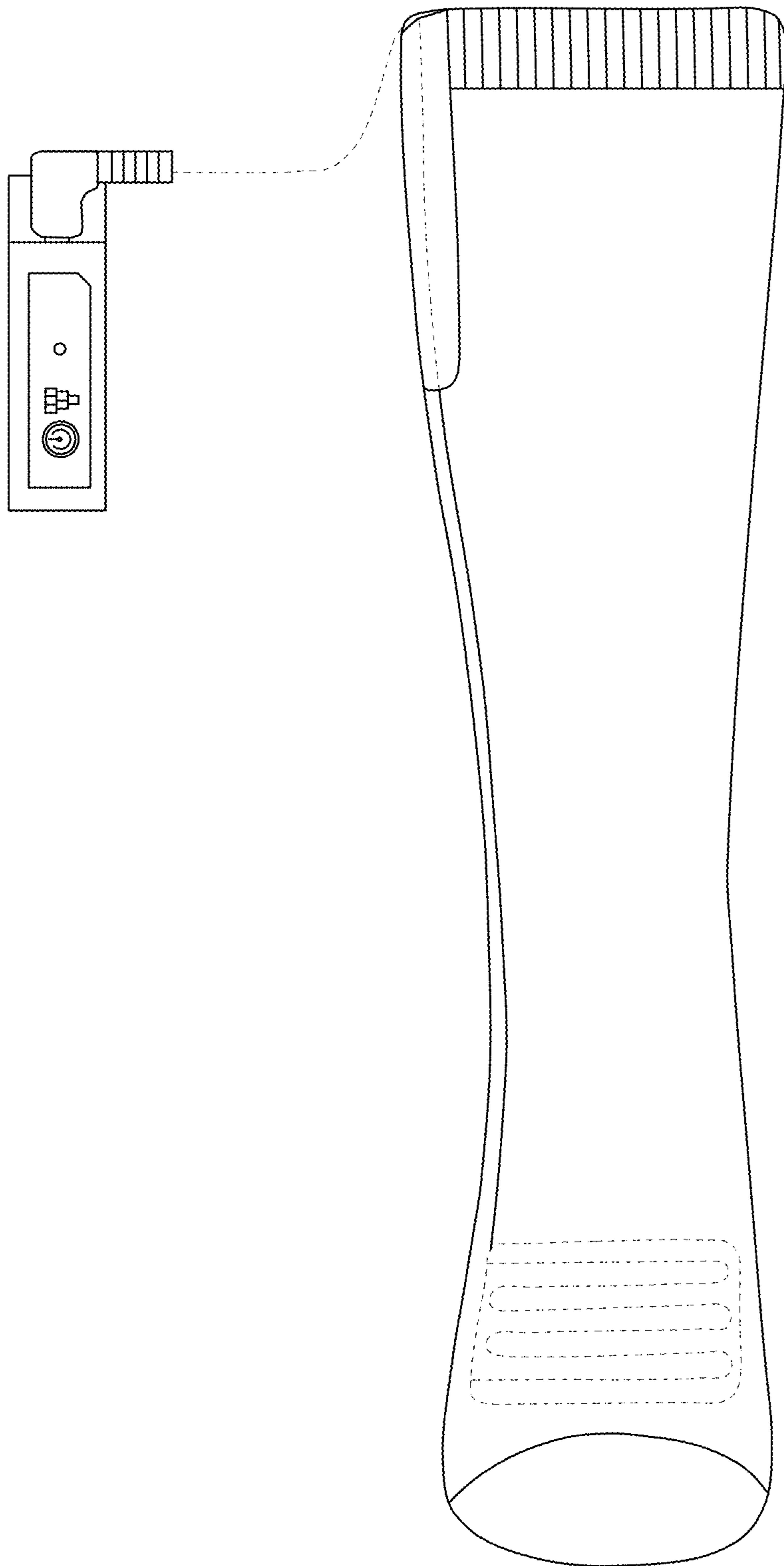

FIG. 2

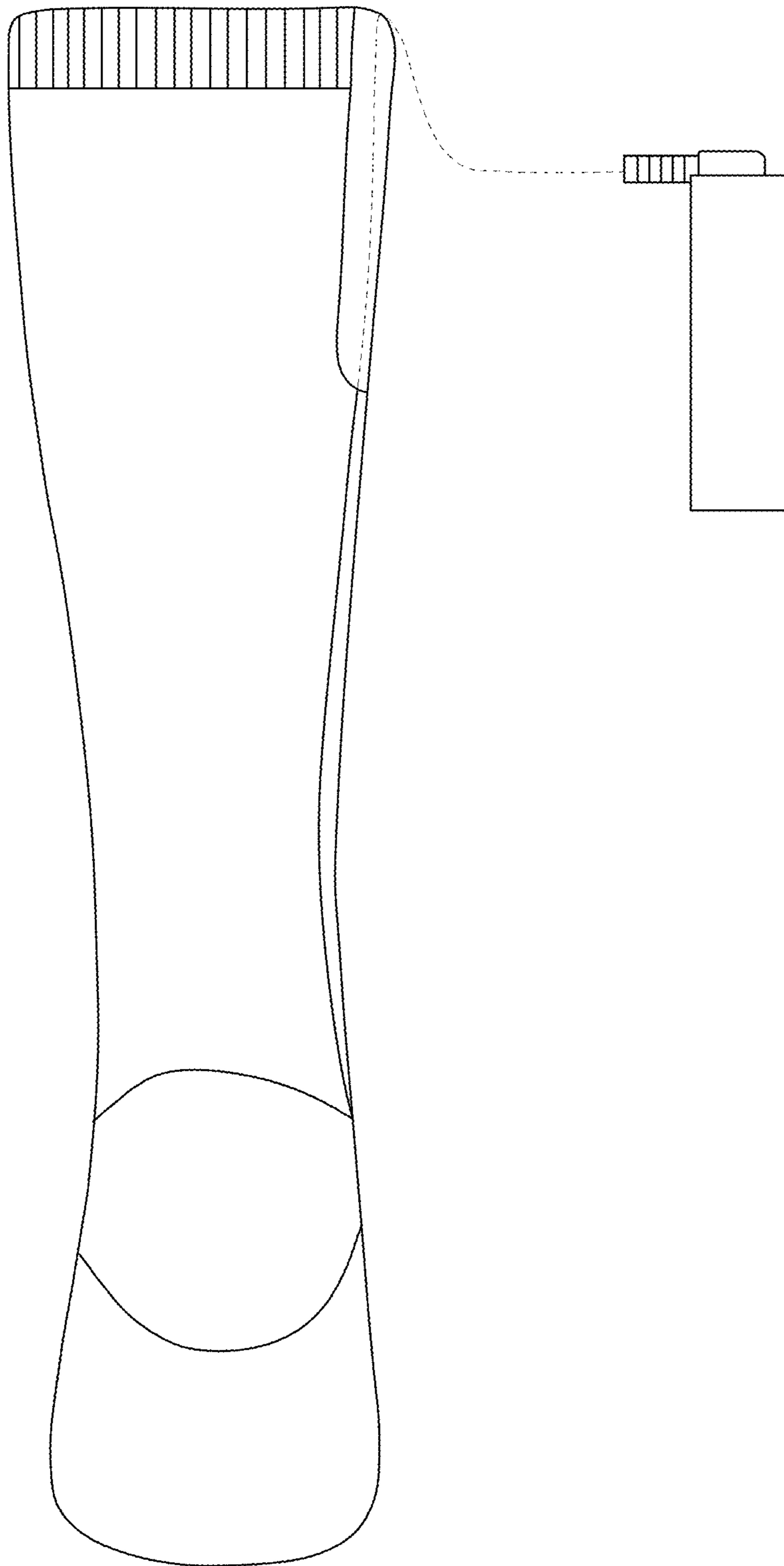

FIG. 3

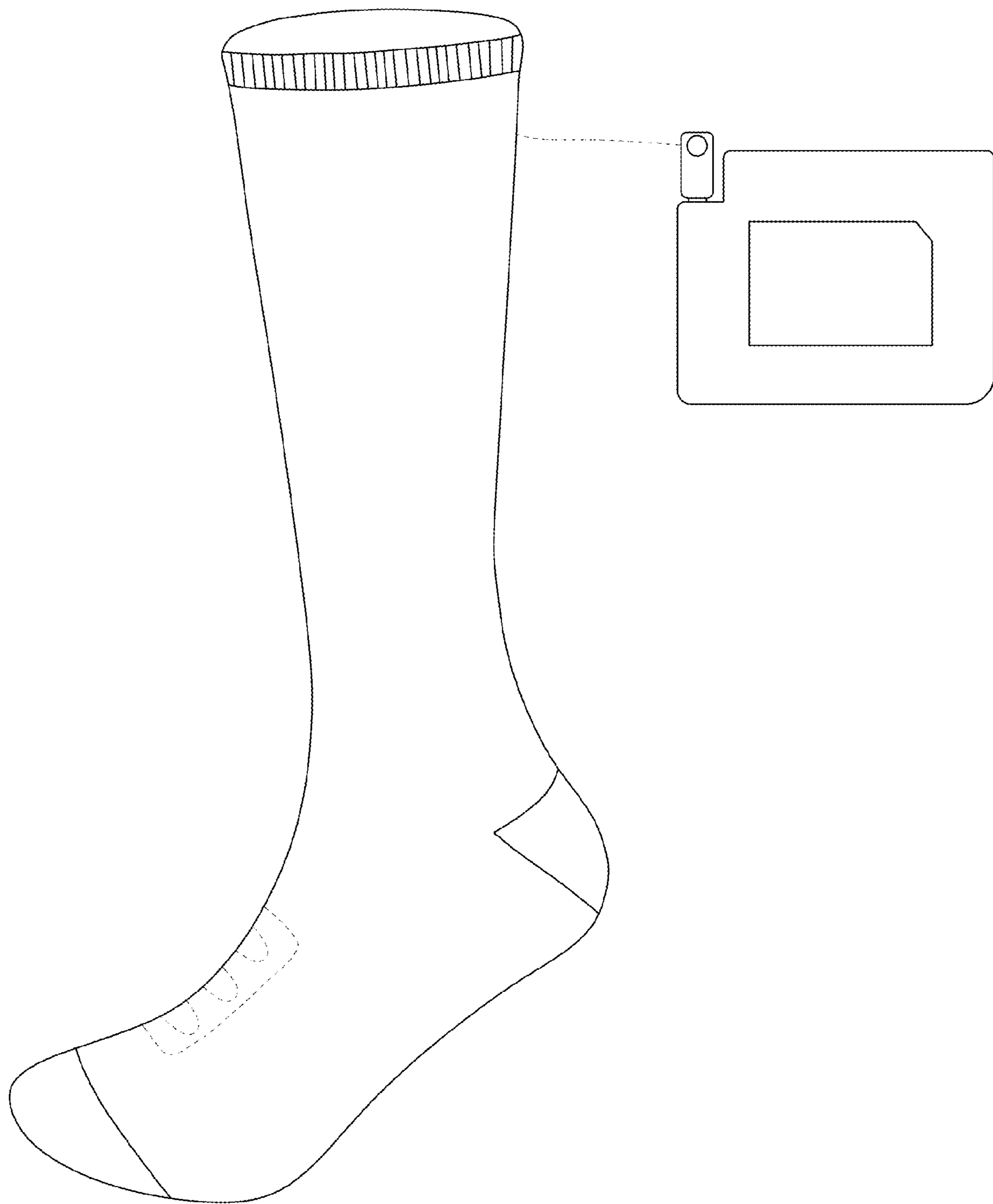

FIG. 4

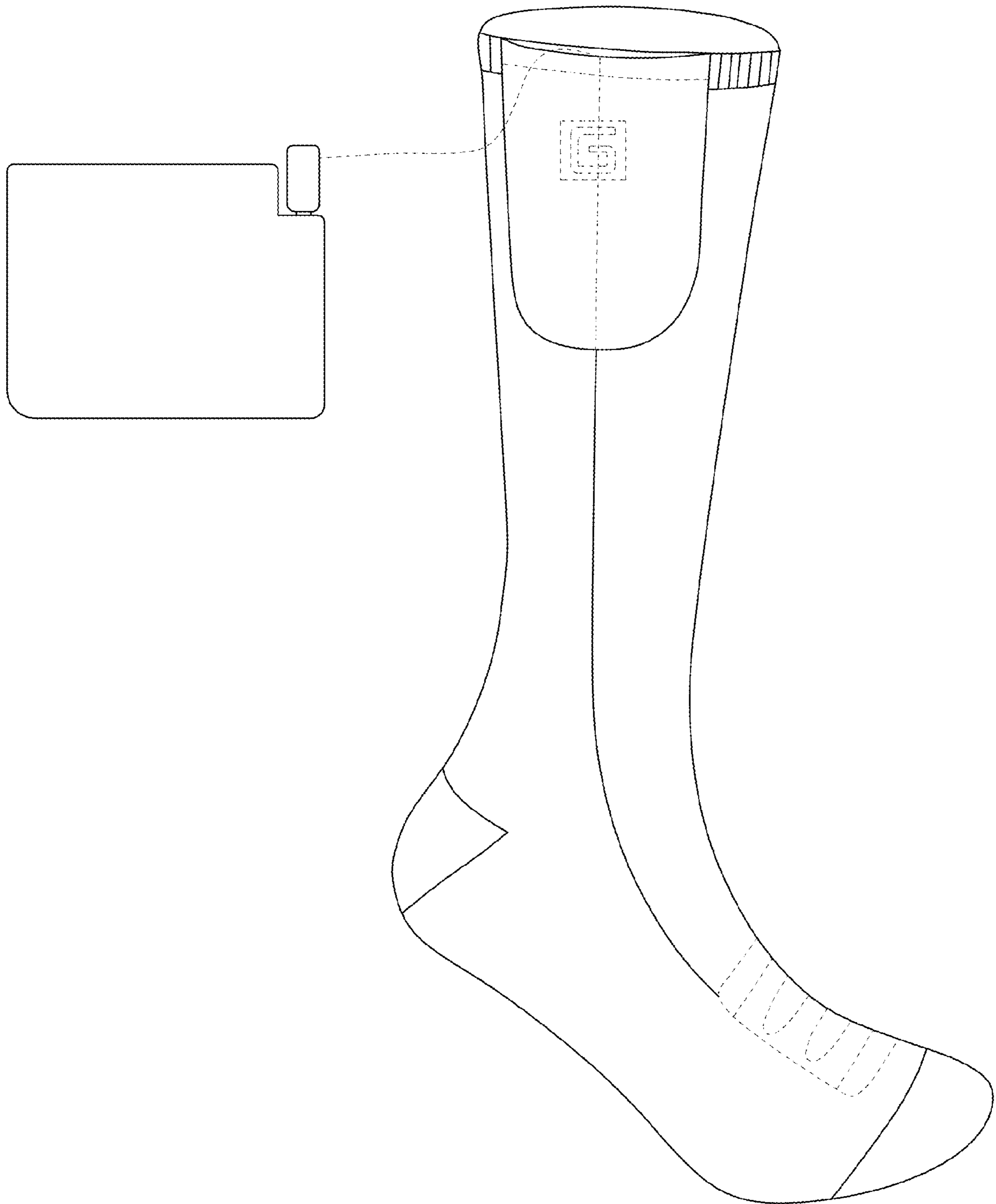

FIG. 5

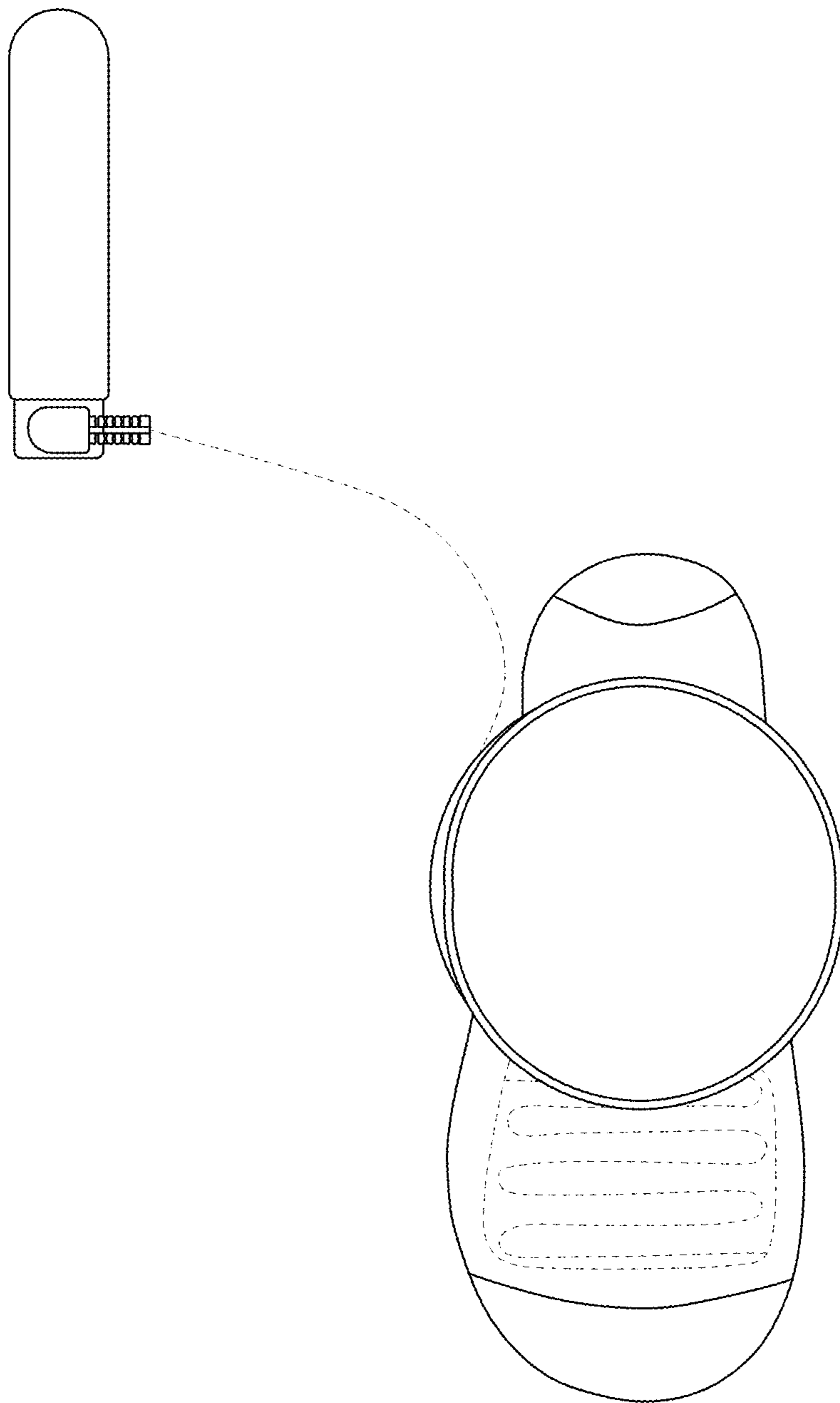

FIG. 6

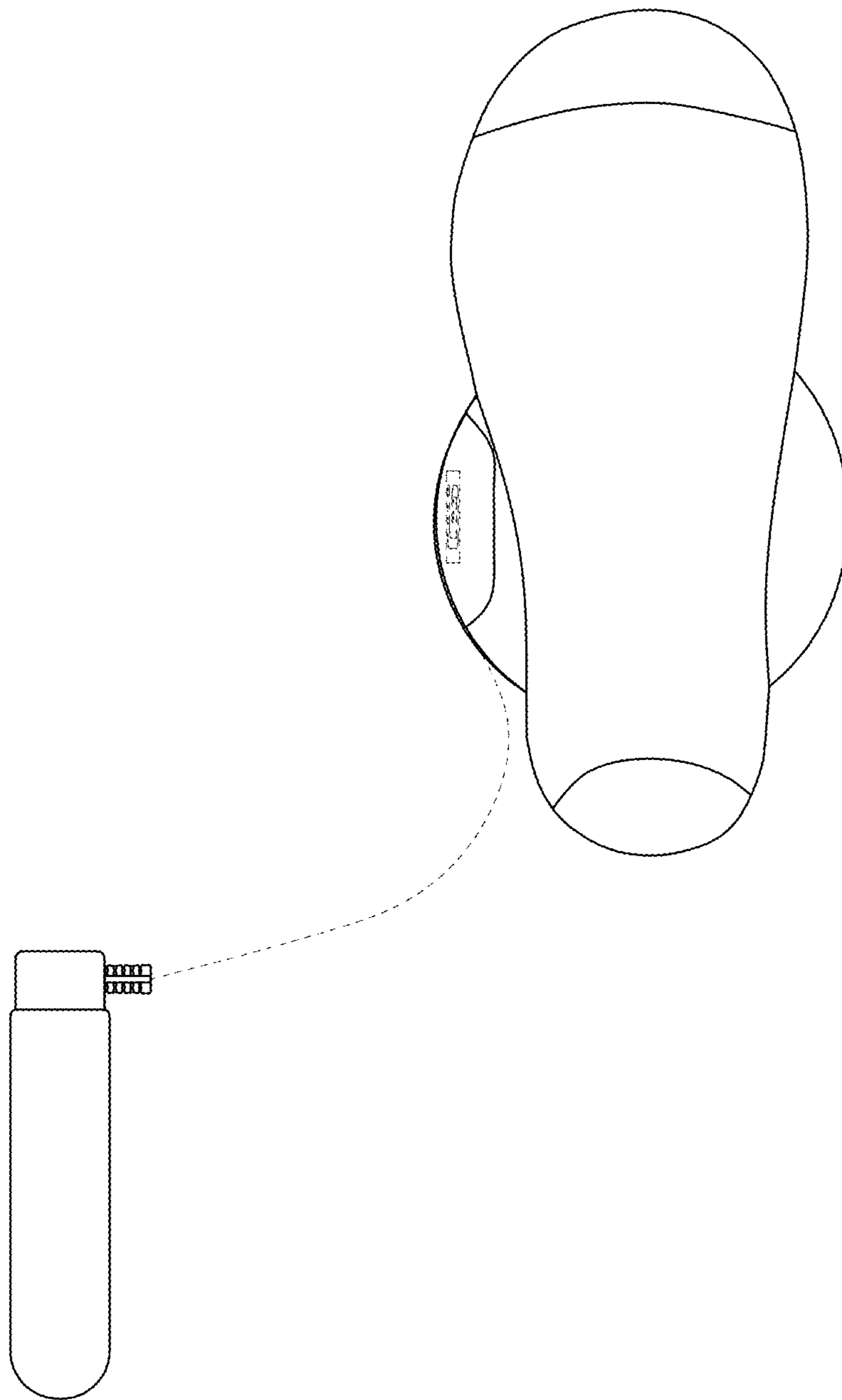

FIG. 7