

US00D899740S

(12) **United States Design Patent**  
**Sussmann**

(10) **Patent No.:** **US D899,740 S**

(45) **Date of Patent:** **\*\* Oct. 27, 2020**

(54) **SHOE**

(71) Applicant: **PUMA SE**, Herzogenaurach (DE)

(72) Inventor: **Reinhold Sussmann**, Scheinfeld (DE)

(73) Assignee: **PUMA SE**, Herzogenaurach (DE)

(\*\*) Term: **15 Years**

(21) Appl. No.: **29/676,871**

(22) Filed: **Jan. 15, 2019**

(30) **Foreign Application Priority Data**

Aug. 27, 2018 (EM) ..... 005621679

Oct. 8, 2018 (EM) ..... 005771185

(51) **LOC (12) Cl.** ..... **02-04**

(52) **U.S. Cl.**  
USPC ..... **D2/953**; D2/947; D2/951; D2/960

(58) **Field of Classification Search**  
USPC ..... D2/902, 906, 908, 916, 918, 925,  
D2/946-962, 977; 36/3 B, 22 R, 24.5,  
36/25 R, 28, 32 R, 34 R, 59 C, 67 A, 103  
CPC ..... A43B 13/00; A43B 13/02; A43B 13/023;  
A43B 13/026; A43B 13/04; A43B 13/08;  
A43B 13/10; A43B 13/12; A43B 13/14;  
A43B 13/141; A43B 13/143; A43B  
13/16; A43B 13/18; A43B 13/181; A43B  
13/187; A43B 13/189; A43B 13/20; A43B  
13/22; A43B 13/223; A43B 13/24; A43B  
13/28; A43B 13/30; A43B 13/32; A43B  
13/34; A43B 13/36  
See application file for complete search history.

(56) **References Cited**

**U.S. PATENT DOCUMENTS**

D55,529 S \* 6/1920 Piper ..... D2/909  
D164,095 S \* 7/1951 Bovay ..... D2/955

D326,179 S \* 5/1992 Walker ..... D2/954  
D336,560 S \* 6/1993 Peterson ..... D2/955  
D411,910 S \* 7/1999 Cessor ..... D2/951  
D819,312 S \* 6/2018 Lashmore ..... D2/947  
D821,073 S \* 6/2018 Matthews ..... D2/947  
D821,076 S \* 6/2018 Matthews ..... D2/953  
D821,713 S \* 7/2018 Matthews ..... D2/947  
D829,420 S \* 10/2018 McWee ..... D2/947  
D829,421 S \* 10/2018 Pope ..... D2/947  
D829,422 S \* 10/2018 Rathburn ..... D2/947  
D829,423 S \* 10/2018 Robusti ..... D2/947  
D834,796 S \* 12/2018 Pope ..... D2/947  
D834,797 S \* 12/2018 Rathburn ..... D2/947  
D834,798 S \* 12/2018 Rathburn ..... D2/947  
D839,564 S \* 2/2019 McMillan ..... D2/947  
D844,954 S \* 4/2019 Sokol ..... D2/947  
D848,126 S \* 5/2019 Rhu ..... D2/947  
D850,078 S \* 6/2019 Lee ..... D2/947  
D853,702 S \* 7/2019 Mokos ..... D2/953

(Continued)

*Primary Examiner* — T Chase Nelson

(74) *Attorney, Agent, or Firm* — Quarles & Brady LLP

(57) **CLAIM**

The ornamental design for a shoe, as shown and described.

**DESCRIPTION**

FIG. 1 is a top, left, and front perspective view of an ornamental design for a shoe;  
FIG. 2 is a left side elevational view of the shoe of FIG. 1;  
FIG. 3 is a right side elevational view of the shoe of FIG. 1;  
FIG. 4 is a front elevational view of the shoe of FIG. 1;  
FIG. 5 is a rear elevational view of the shoe of FIG. 1;  
FIG. 6 is a top plan view of the shoe of FIG. 1; and,  
FIG. 7 is a bottom plan view of the shoe of FIG. 1.  
The dash-dash-dash broken lines are included for the purpose of illustrating portions of the shoe that form no part of the claimed design.

**1 Claim, 6 Drawing Sheets**

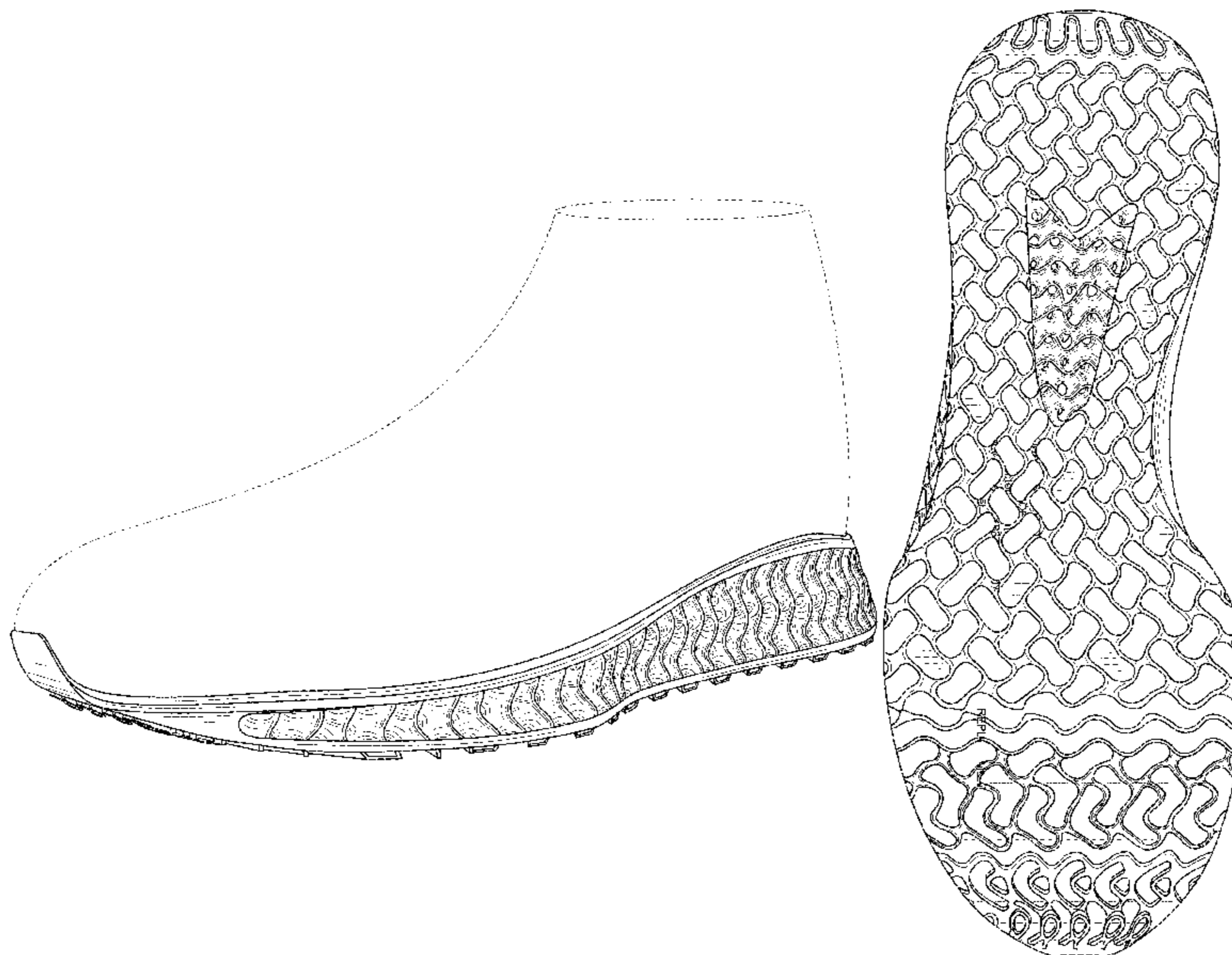

(56)

References Cited

U.S. PATENT DOCUMENTS

D854,289	S *	7/2019	Nethongkome .....	D2/947
D854,292	S *	7/2019	Mokos .....	D2/953
D854,293	S *	7/2019	Mokos .....	D2/953
D854,797	S *	7/2019	Mokos .....	D2/953
D855,293	S *	8/2019	Zhou .....	D2/902
D857,360	S *	8/2019	Hardy .....	D2/953
D858,053	S *	9/2019	Schultze .....	D2/947
D864,530	S *	10/2019	Verfl .....	D2/908
D864,536	S *	10/2019	Mokos .....	D2/953
D864,537	S *	10/2019	Mokos .....	D2/953
D864,538	S *	10/2019	Mokos .....	D2/953
D876,761	S *	3/2020	Zhu .....	D2/947
D878,018	S *	3/2020	Petrenka .....	D2/947
D879,426	S *	3/2020	Raasch .....	D2/947
D881,535	S *	4/2020	Tæstensen .....	D2/947
D881,536	S *	4/2020	Pope .....	D2/947
2006/0059716	A1 *	3/2006	Yamashita .....	A43B 13/223 36/59 R
2019/0208859	A1 *	7/2019	Mokos .....	A43B 13/187
2019/0223552	A1 *	7/2019	Hollinger .....	A43B 13/145

\* cited by examiner



FIG. 1

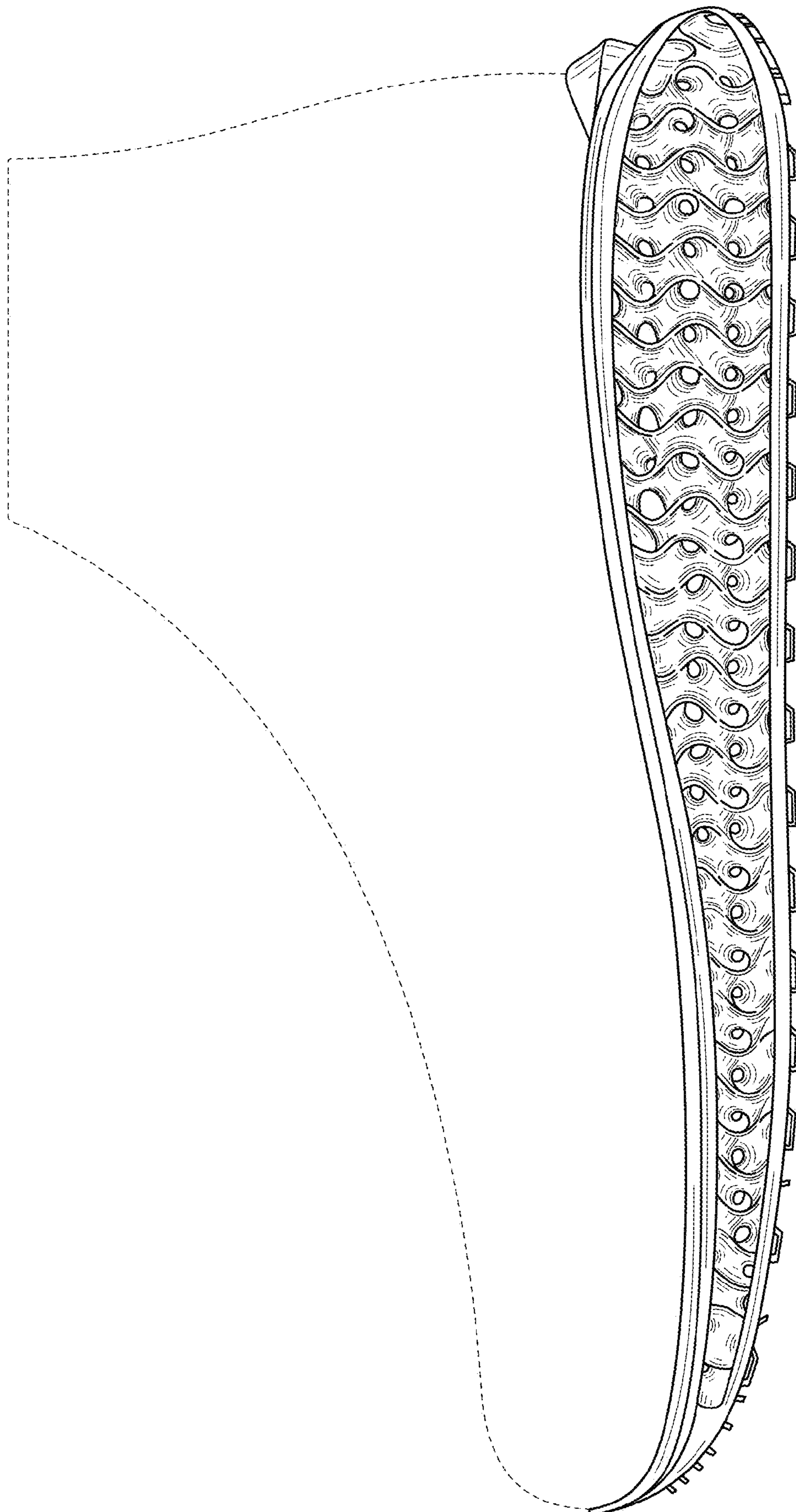

FIG. 2

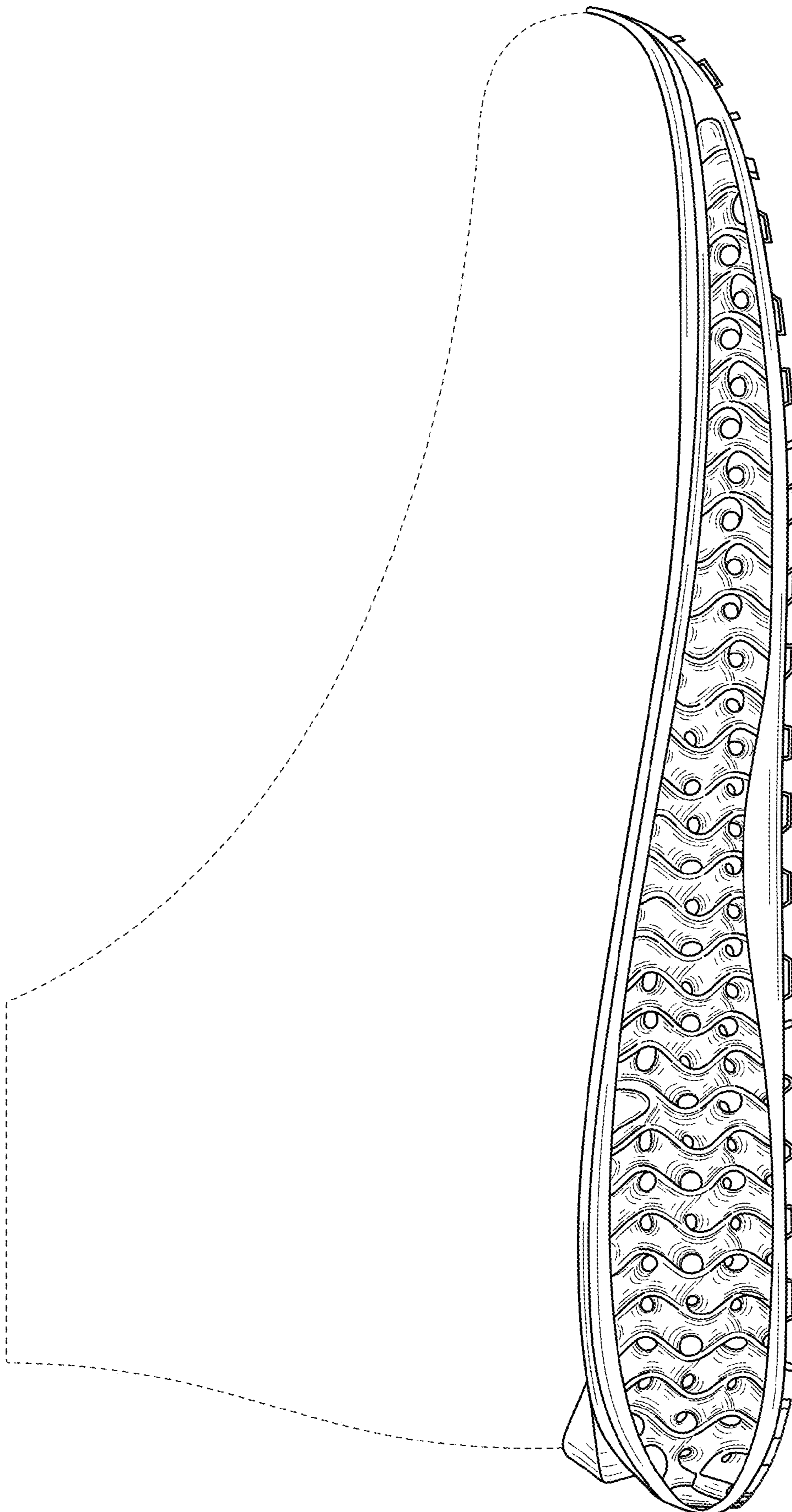

FIG. 3

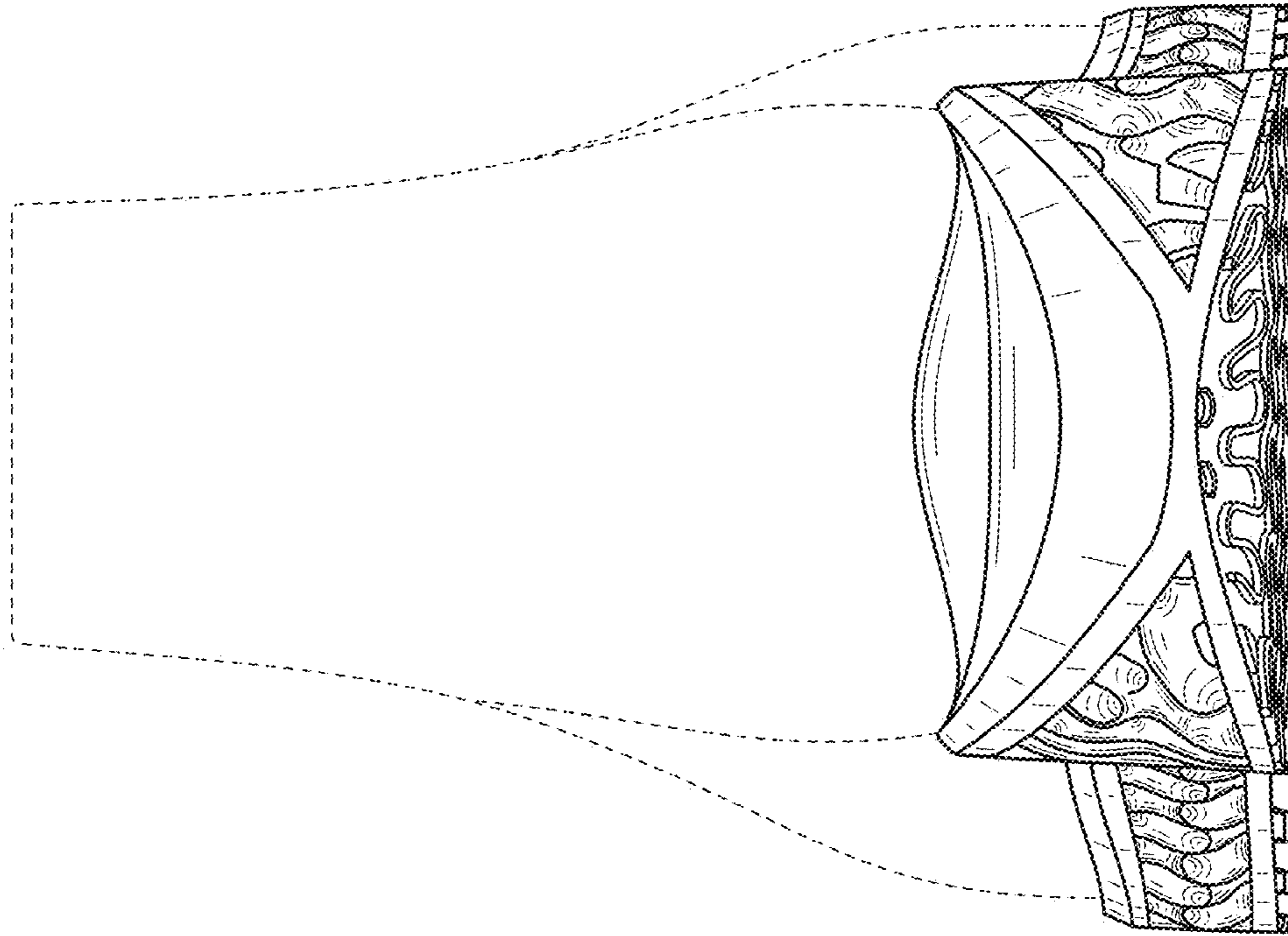

FIG. 5

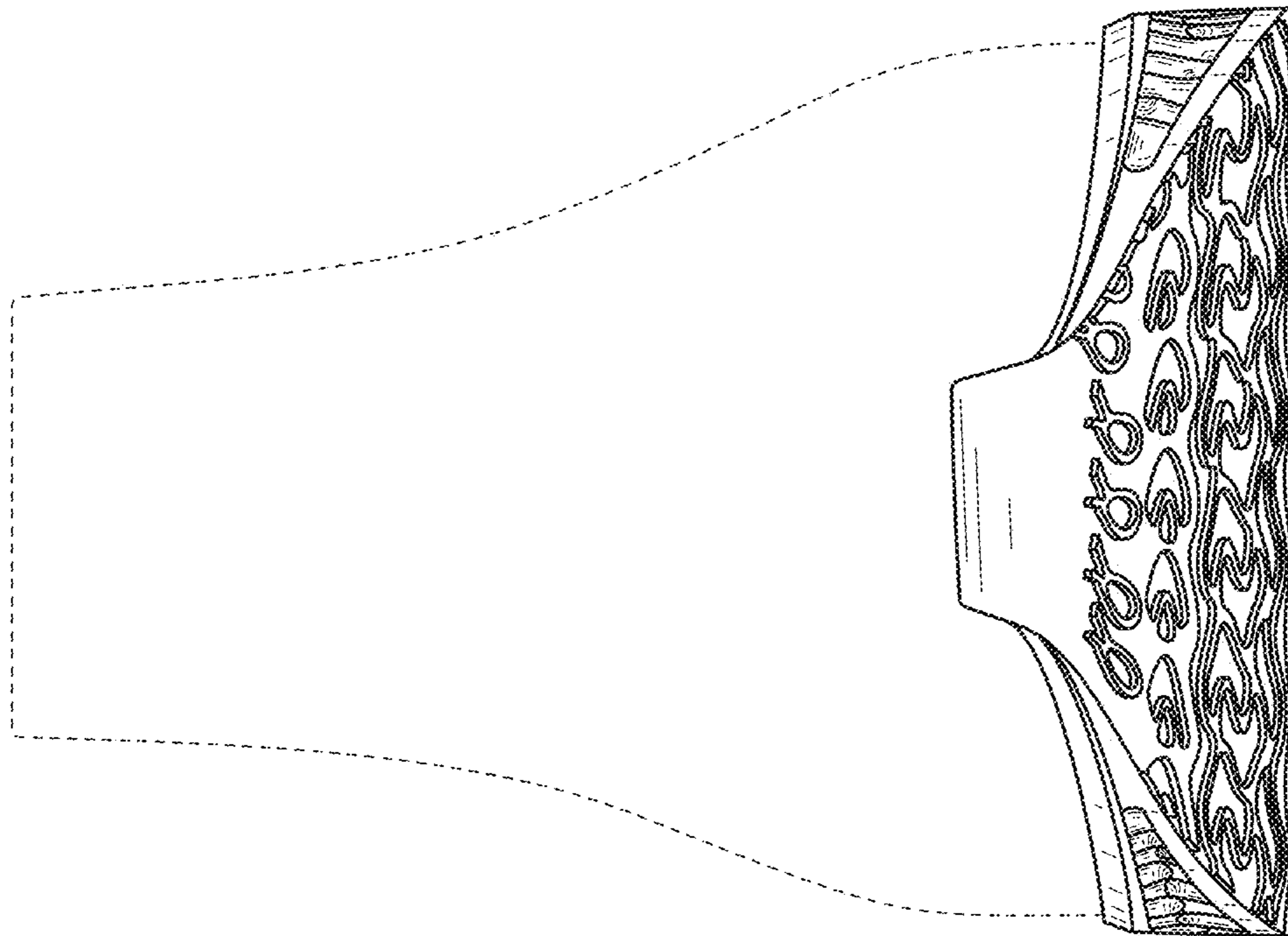

FIG. 4

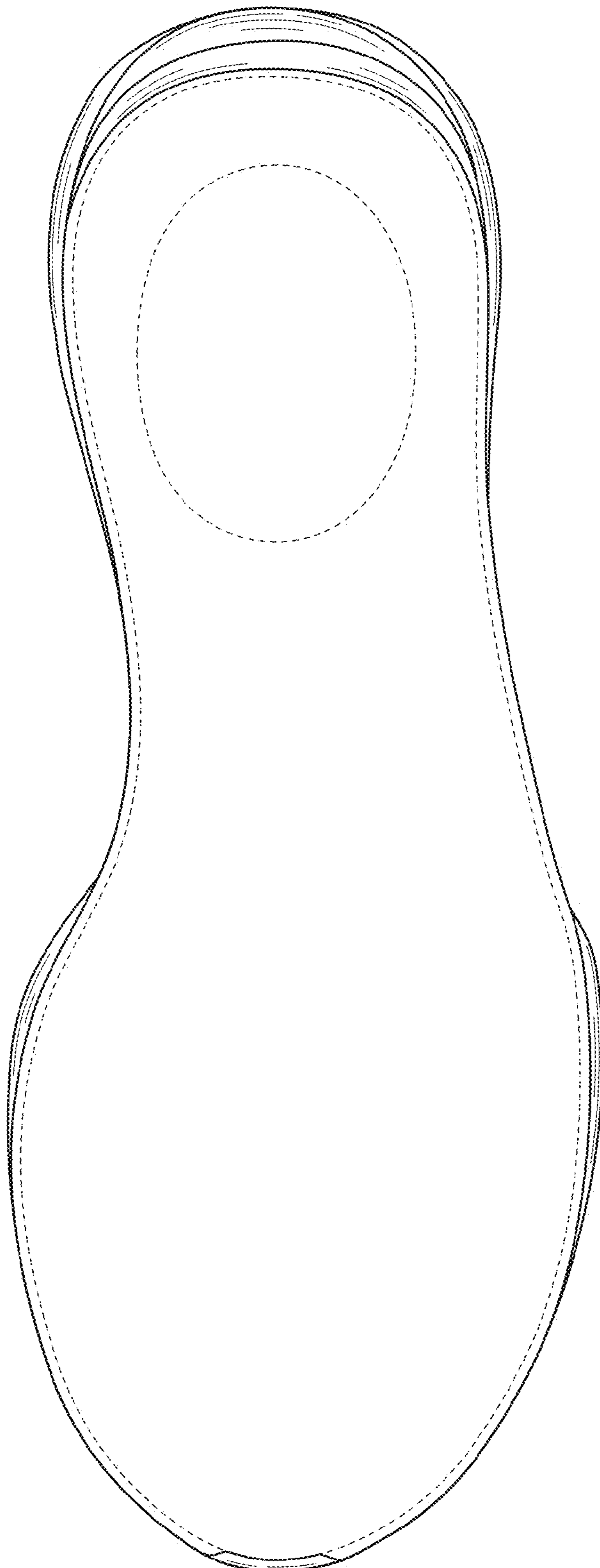

FIG. 6

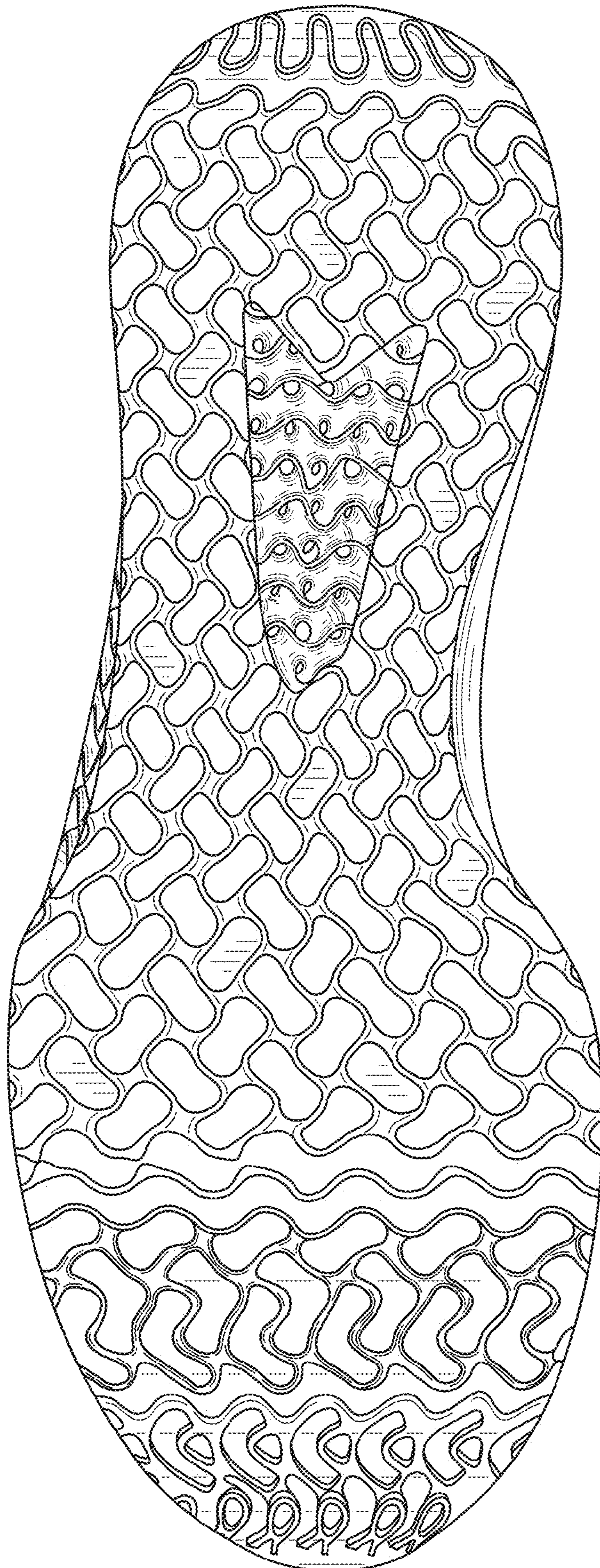

FIG. 7