



US00D899616S

(12) **United States Design Patent**
Jung

(10) **Patent No.:** **US D899,616 S**

(45) **Date of Patent:** **** Oct. 20, 2020**

(54) **SKIN CARE MASSAGER**

(71) Applicant: **CLASSYS INC.**, Seoul (KR)

(72) Inventor: **Sung Jae Jung**, Seoul (KR)

(73) Assignee: **CLASSYS INC.**, Seoul (KR)

(**) Term: **15 Years**

(21) Appl. No.: **29/621,910**

(22) Filed: **Oct. 12, 2017**

(30) **Foreign Application Priority Data**

Apr. 12, 2017 (KR) 30-2017-0017008

(51) **LOC (12) Cl.** **28-03**

(52) **U.S. Cl.**
USPC **D24/215**

(58) **Field of Classification Search**

USPC D24/200, 211, 212, 213, 214, 215;
601/19, 22, 40, 46, 52, 63, 99, 110-113,
601/118, 119, 120, 121, 125, 128, 129,
601/DIG. 12, DIG. 14, DIG. 15, DIG. 16,
601/DIG. 17

CPC .. A61H 1/00; A61H 1/001; A61H 2015/0007;
A61H 2015/0042; A61H 2015/0014;
A61H 15/00; A61H 15/0092; A61H
37/00; A61H 11/00; A61H 21/00

See application file for complete search history.

(56) **References Cited**

U.S. PATENT DOCUMENTS

- 3,375,381 A * 3/1968 Tavel A61H 23/0263
310/81
- D234,724 S * 4/1975 Tavel D24/214
- 3,994,289 A * 11/1976 Thomas A61H 39/04
601/120
- D248,668 S * 7/1978 Brehm 601/131

- D263,077 S * 2/1982 Stanton D24/212
- D268,524 S * 4/1983 D'Addio D24/211
- D371,442 S * 7/1996 Semyonova D24/214
- D385,965 S * 11/1997 Wallesen D24/212
- D390,966 S * 2/1998 Huang D24/211
- 6,254,555 B1 * 7/2001 Sevier A61H 7/001
601/134
- D454,959 S * 3/2002 Harris D24/214
- D466,612 S * 12/2002 Harris D24/215
- D481,132 S * 10/2003 Kim D24/200
- D485,910 S * 1/2004 Chan D24/215
- D530,823 S * 10/2006 Sevier D24/214
- D540,947 S * 4/2007 Jung D24/167
- D600,357 S * 9/2009 Chaput D24/214
- 7,662,088 B2 * 2/2010 McCaffrey A61H 19/44
600/38
- D630,761 S * 1/2011 Marshall D24/215
- D633,625 S * 3/2011 Maderazzo D24/200
- D637,728 S * 5/2011 Sevier D24/211
- D652,527 S * 1/2012 Marshall D24/215
- D666,733 S * 9/2012 Caggiano D24/215
- D669,997 S * 10/2012 Crockford D24/215
- D673,687 S * 1/2013 Zeng D24/215

(Continued)

Primary Examiner — Sandra S Snapp

(74) *Attorney, Agent, or Firm* — Westerman, Hattori,
Daniels & Adrian, LLP

(57) **CLAIM**

The ornamental design for a skin care massager, as shown and described.

DESCRIPTION

FIG. 1 is a perspective view of a skin care massager showing our new design;
FIG. 2 is a front elevational view thereof;
FIG. 3 is a rear elevational view thereof;
FIG. 4 is a left side elevational view thereof;
FIG. 5 is a right side elevational view thereof;
FIG. 6 is a top plan view thereof; and,
FIG. 7 is a bottom plan view thereof.

1 Claim, 7 Drawing Sheets

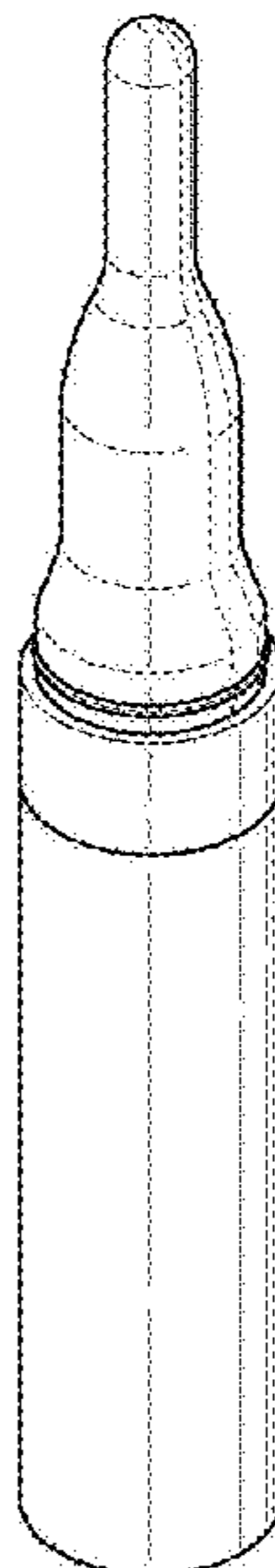

(56)

References Cited

U.S. PATENT DOCUMENTS

D681,842 S *	5/2013	Chang	D24/215
D685,105 S *	6/2013	Marshall	D24/215
D688,382 S *	8/2013	Marshall	D24/215
D723,709 S *	3/2015	Topolovac	D24/215
D738,523 S *	9/2015	Tong	D24/215
D753,339 S *	4/2016	Greeley	D27/162
D759,260 S *	6/2016	Topolovac	D24/215
D768,308 S *	10/2016	Hetzel	D24/214
D814,695 S *	4/2018	Petteys	D27/195
D827,849 S *	9/2018	Marshall	D24/215
D841,761 S *	2/2019	Lin	D22/117
D854,699 S *	7/2019	Peterson	D24/214

* cited by examiner

FIG. 1

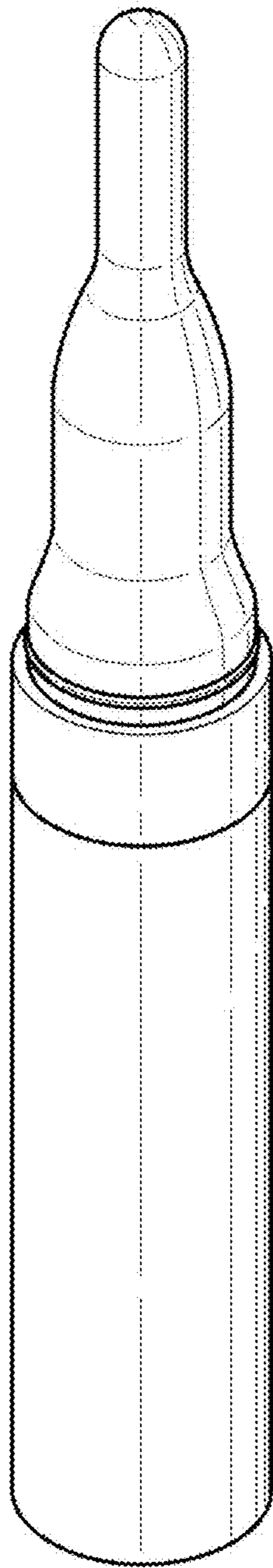

FIG. 2

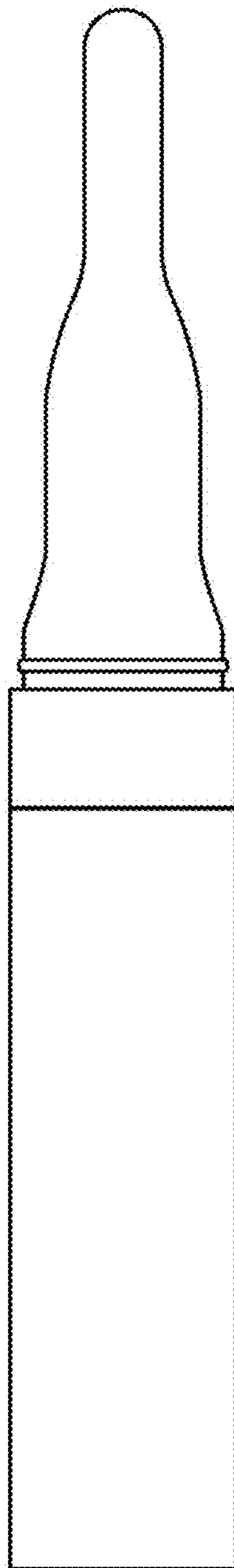

FIG. 3

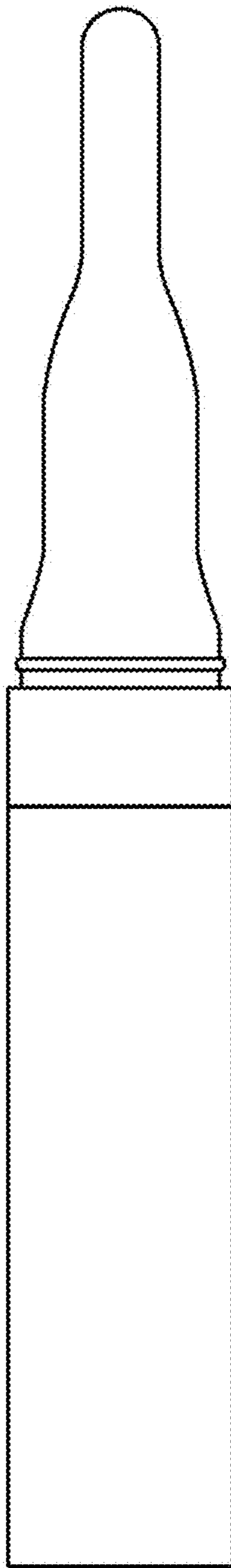

FIG. 4

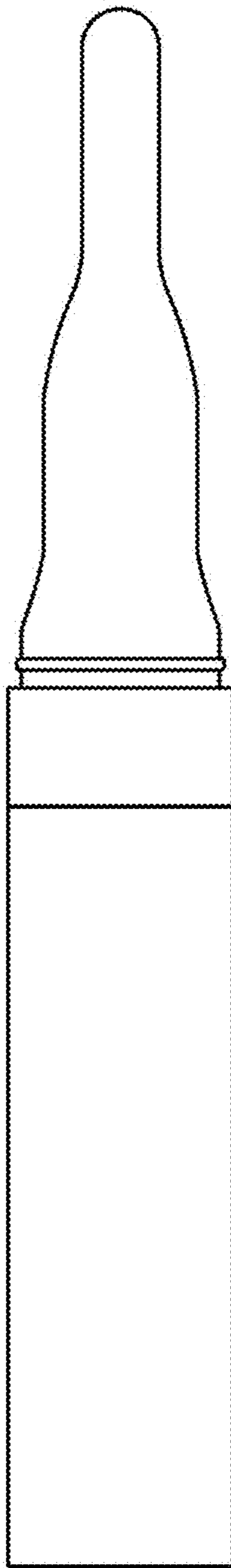

FIG. 5

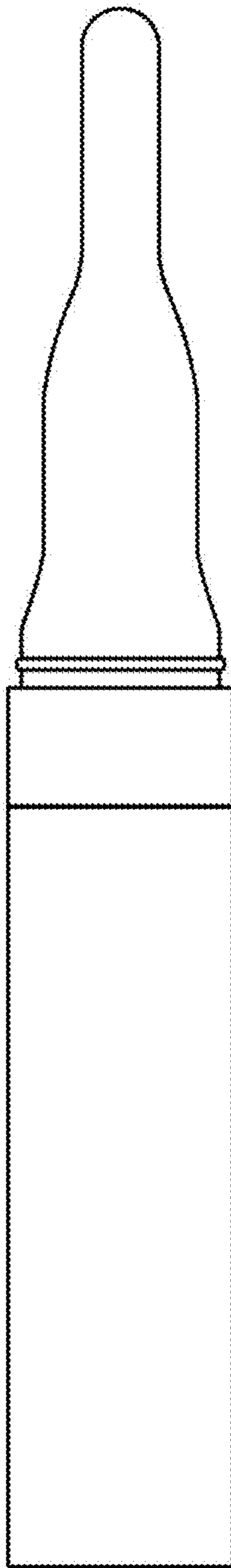

FIG. 6

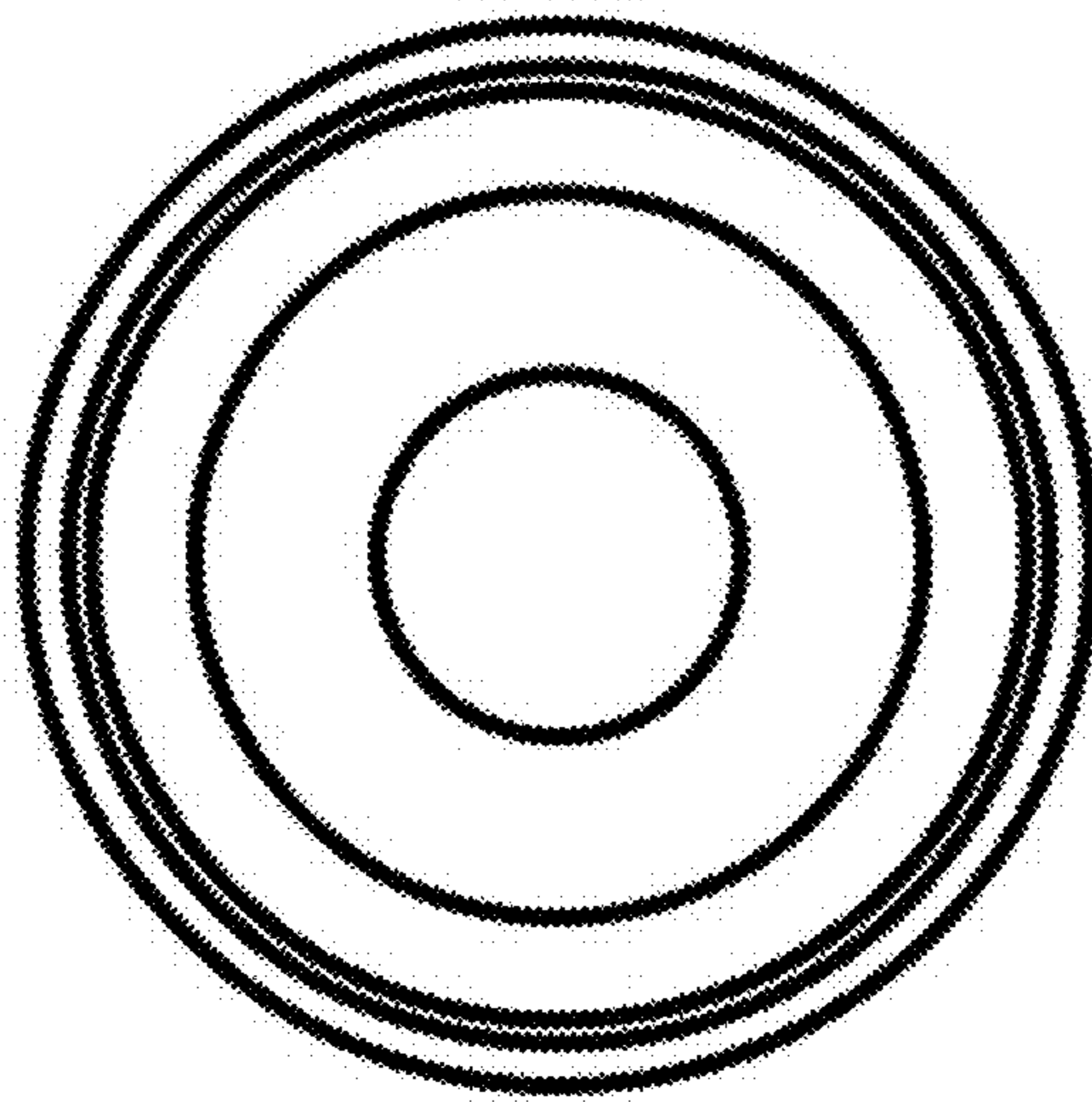

FIG. 7

