



US00D899611S

(12) **United States Design Patent** (10) **Patent No.:** **US D899,611 S**  
**Igaue et al.** (45) **Date of Patent:** **\*\* Oct. 20, 2020**

(54) **WARMER**

(71) Applicant: **KOBAYASHI Healthcare International Inc.**, Dalton, GA (US)

(72) Inventors: **Tsuyoshi Igaue**, Dalton, GA (US);  
**Daisaku Nagaike**, Dalton, GA (US)

(73) Assignee: **KOBAYASHI Healthcare International Inc.**, Dalton, GA (US)

(\*\*) Term: **15 Years**

(21) Appl. No.: **29/676,566**

(22) Filed: **Jan. 11, 2019**

(51) **LOC (12) Cl.** ..... **24-04**

(52) **U.S. Cl.**  
USPC ..... **D24/206**

(58) **Field of Classification Search**  
USPC ..... D24/200–207, 208–215, 194, 187–192,  
D24/183, 184, 118; D9/756, 414, 424,  
D9/432, 668, 702, 703, 707, 709–711,  
D9/569; D6/616, 601, 604, 622, 582,  
D6/583, 592, 596, 595, 605, 606; D5/1,  
D5/2, 25, 53, 57, 61; D12/203, 212, 221;  
D7/550.1; D32/55–58; D30/145;  
D21/191, 302, 306, 671, 686, 784, 797,  
D21/798, 803, 809; D19/67–69;  
D25/141, 143, 147, 152, 157, 163;  
D29/113, 101.5, 120.1, 121.1, 707;  
D27/139, 141, 144, 152, 154, 159;  
D3/327; D23/314, 316, 332, 351, 355,  
D23/364, 366, 77; 601/15, 40, 64;  
602/2, 7; 606/27  
CPC ..... A61F 7/00; A61F 7/02; A61F 2007/0021;  
A61F 2007/0001; A61F 7/007; A61F  
7/034; A61F 7/0085; A61F 2007/0036;  
A61F 2007/0078; A61F 2007/0085; A61F  
2007/0087; A61N 1/025; A61N 1/06;  
A61N 1/26; A61N 1/3603; A61N  
1/36031; A61N

(Continued)

(56) **References Cited**

U.S. PATENT DOCUMENTS

754,329 A \* 3/1904 Milliken ..... A47C 27/001  
5/722  
D167,743 S \* 9/1952 Dorfman ..... D24/207  
(Continued)

*Primary Examiner* — T Chase Nelson

*Assistant Examiner* — Kelly L Gross

(74) *Attorney, Agent, or Firm* — Sterne, Kessler,  
Goldstein & Fox P.L.L.C.

(57) **CLAIM**

The ornamental design for a warmer, as shown and described.

**DESCRIPTION**

FIG. 1 is a top perspective view of a warmer showing the claimed design;  
FIG. 2 is a bottom perspective view thereof;  
FIG. 3 is a top view thereof;  
FIG. 4 is a bottom view thereof;  
FIG. 5 is a right side view thereof;  
FIG. 6 is a left side view thereof;  
FIG. 7 is a front view thereof;  
FIG. 8 is a rear view thereof;  
FIG. 9 is a top perspective view of another embodiment thereof;  
FIG. 10 is a bottom perspective view thereof;  
FIG. 11 is a top view thereof;  
FIG. 12 is a bottom view thereof;  
FIG. 13 is a right side view thereof;  
FIG. 14 is a left side view thereof;  
FIG. 15 is a front view thereof; and,  
FIG. 16 is a rear view thereof.

The dashed broken lines in the figures show portions of the warmer that form no part of the claimed design.

The dot-dash broken lines in the figures show boundaries that form no part of the claimed design.

**1 Claim, 10 Drawing Sheets**

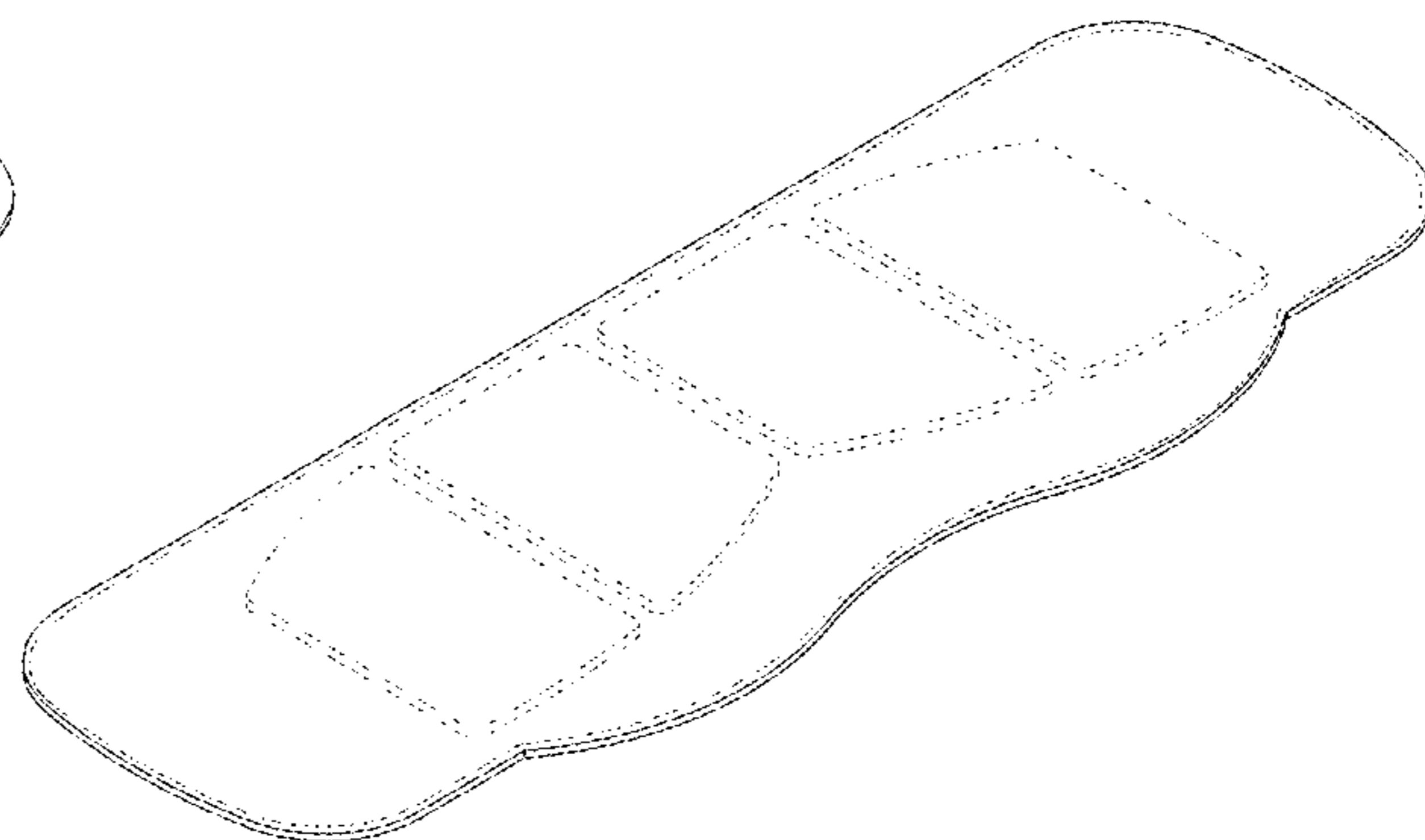
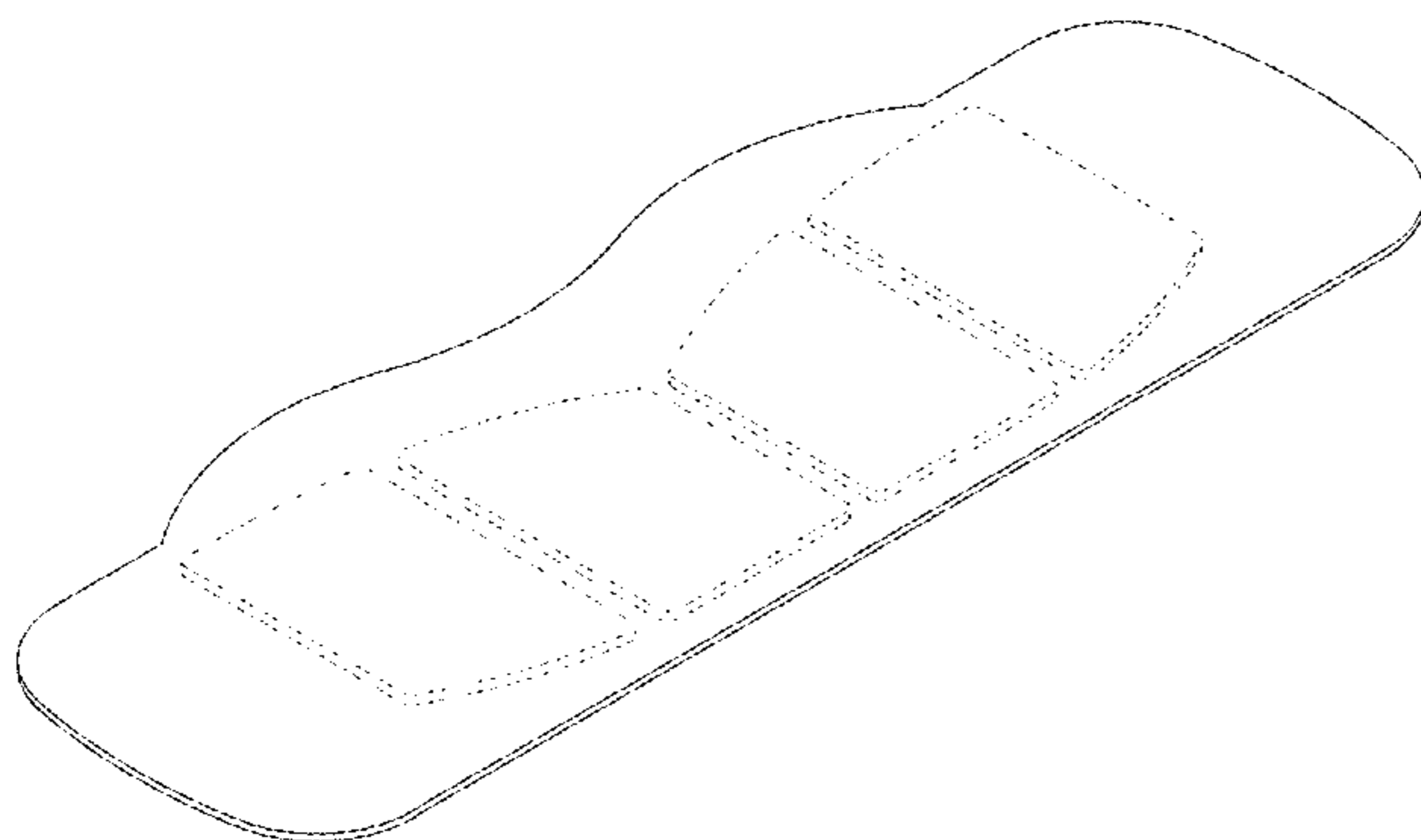

(58) **Field of Classification Search**

CPC .. 1/36034; A61H 1/0218; A61H 39/00; A61H 39/04; A61H 15/00; A61H 7/001-003; A61H 39/02; A61H 39/08; A63F 2300/1068; A43B 3/108; A47G 27/02; A47K 3/002; A47K 3/04; A47K 3/003; A47L 23/22; B60N 3/04; B60N 3/044; B60N 3/048; H05B 1/0288

See application file for complete search history.

(56) **References Cited**

U.S. PATENT DOCUMENTS

4,462,224 A \* 7/1984 Dunshee ..... A61F 7/106  
62/530  
4,700,706 A \* 10/1987 Munch ..... A61F 7/02  
604/113  
D321,761 S \* 11/1991 Shimizu ..... D24/168  
D327,329 S \* 6/1992 Hubbard ..... D24/206  
D328,792 S \* 8/1992 Salmon ..... D24/206  
D342,790 S \* 12/1993 Zona ..... D24/207  
5,336,255 A \* 8/1994 Kanare ..... A61N 1/0452  
607/112  
D354,349 S \* 1/1995 Grein ..... D24/124  
D372,984 S \* 8/1996 Jordan ..... D24/206  
D417,007 S \* 11/1999 Davis ..... D24/200  
D420,746 S \* 2/2000 Cardy ..... D24/224  
D435,910 S \* 1/2001 Davis ..... D24/189  
D467,006 S \* 12/2002 Knight ..... D24/206  
D469,878 S \* 2/2003 Davis ..... D24/189  
D472,321 S \* 3/2003 Davis ..... D24/189  
D474,544 S \* 5/2003 Hoglund ..... D24/206  
D509,694 S \* 9/2005 Pitchford ..... D6/601  
D526,720 S \* 8/2006 Dodo ..... D24/206  
D526,722 S \* 8/2006 Dodo ..... D24/206  
D527,829 S \* 9/2006 Dodo ..... D24/206  
D550,847 S \* 9/2007 Kixmiller ..... D24/190  
D553,410 S \* 10/2007 Kramer ..... D6/583  
D556,333 S \* 11/2007 Hoffman ..... D24/200  
D571,015 S \* 6/2008 Freeland ..... D24/189  
D571,922 S \* 6/2008 Freeland ..... D24/189  
D572,367 S \* 7/2008 Freeland ..... D24/189  
D572,825 S \* 7/2008 Freeland ..... D24/189  
D572,826 S \* 7/2008 Freeland ..... D24/189  
D574,503 S \* 8/2008 Reed ..... D24/206  
D577,607 S \* 9/2008 Friedland ..... D9/707  
D580,784 S \* 11/2008 Kila ..... D9/709  
D582,047 S \* 12/2008 Yim ..... D24/206  
D583,479 S \* 12/2008 Yim ..... D24/206  
D583,958 S \* 12/2008 Usui ..... D24/206  
D583,959 S \* 12/2008 Yim ..... D24/206  
D587,811 S \* 3/2009 Uchiyama ..... D24/206  
D587,812 S \* 3/2009 Uchiyama ..... D24/206  
D591,013 S \* 4/2009 Mose ..... D30/118  
D593,682 S \* 6/2009 Freeland ..... D24/189  
D596,305 S \* 7/2009 Usui ..... D24/206  
D599,484 S \* 9/2009 Gray ..... D24/206  
D602,598 S \* 10/2009 Yim ..... D24/206  
D609,357 S \* 2/2010 Yim ..... D24/206

D609,358 S \* 2/2010 Yim ..... D24/206  
D609,359 S \* 2/2010 Yim ..... D24/206  
D609,360 S \* 2/2010 Yim ..... D24/206  
D613,181 S \* 4/2010 Friedland ..... D9/707  
D620,787 S \* 8/2010 Moriya ..... D9/416  
D627,076 S \* 11/2010 Matsuo ..... D24/206  
D627,078 S \* 11/2010 Matsuo ..... D24/206  
D628,004 S \* 11/2010 Moorefield ..... D6/601  
D628,705 S \* 12/2010 Usui ..... D24/206  
D628,706 S \* 12/2010 Usui ..... D24/206  
D629,914 S \* 12/2010 Hunter ..... D24/207  
D636,498 S \* 4/2011 Smith ..... D24/206  
D656,235 S \* 3/2012 Howell ..... D24/207  
D658,187 S \* 4/2012 Diebel ..... G06F 1/1679  
D14/440  
8,261,734 B2 \* 9/2012 Dodo ..... A61F 7/034  
126/204  
D679,823 S \* 4/2013 Daniels ..... D24/206  
D682,466 S \* 5/2013 Cantelmo ..... D28/4  
D683,035 S \* 5/2013 Dunshee ..... D24/189  
D683,040 S \* 5/2013 Arsenault ..... D24/206  
D685,489 S \* 7/2013 Nishioka ..... D24/206  
D703,826 S \* 4/2014 Nishioka ..... D24/206  
D704,850 S \* 5/2014 Nishioka ..... D24/206  
D706,944 S \* 6/2014 Igaue ..... D24/206  
8,807,127 B2 \* 8/2014 Igaki ..... A61F 7/034  
126/263.02  
D713,966 S \* 9/2014 Hoonakker ..... D24/189  
8,945,072 B2 \* 2/2015 Oda ..... A61F 7/03  
604/291  
D726,391 S \* 4/2015 Clark ..... D2/502  
D726,928 S \* 4/2015 Suzuki ..... D24/206  
D737,986 S \* 9/2015 Arbesman ..... D24/189  
D745,975 S \* 12/2015 Igaue ..... D24/206  
D746,480 S \* 12/2015 Usui ..... D24/206  
D758,677 S \* 6/2016 Maniates ..... D30/144  
D766,579 S \* 9/2016 Stegmeyer ..... A45F 3/12  
D3/327  
9,463,914 B2 \* 10/2016 Andochick ..... B65D 73/02  
D783,854 S \* 4/2017 Biser ..... D24/206  
D787,080 S \* 5/2017 Baltazar ..... A61F 7/02  
D24/206  
D797,943 S \* 9/2017 Long ..... D24/189  
D821,597 S \* 6/2018 Martinez ..... D24/207  
D848,004 S \* 5/2019 Del Rossi ..... D24/189  
D851,270 S \* 6/2019 Biser ..... D24/206  
D857,218 S \* 8/2019 Fan ..... D24/206  
D862,720 S \* 10/2019 Cutone ..... D24/206  
D863,562 S \* 10/2019 Hahn ..... D24/189  
D865,196 S \* 10/2019 Godfrey ..... D24/206  
D873,428 S \* 1/2020 Godfrey ..... D24/206  
D875,548 S \* 2/2020 Mahin ..... D9/707  
D875,958 S \* 2/2020 Emslander ..... D24/189  
D877,350 S \* 3/2020 Biser ..... D24/206  
2008/0200971 A1 \* 8/2008 Dodo ..... F24V 30/00  
607/108  
2009/0090346 A1 \* 4/2009 Ajiri ..... A61F 7/034  
126/204  
2012/0143292 A1 \* 6/2012 Matsuo ..... A61F 7/032  
607/96

\* cited by examiner



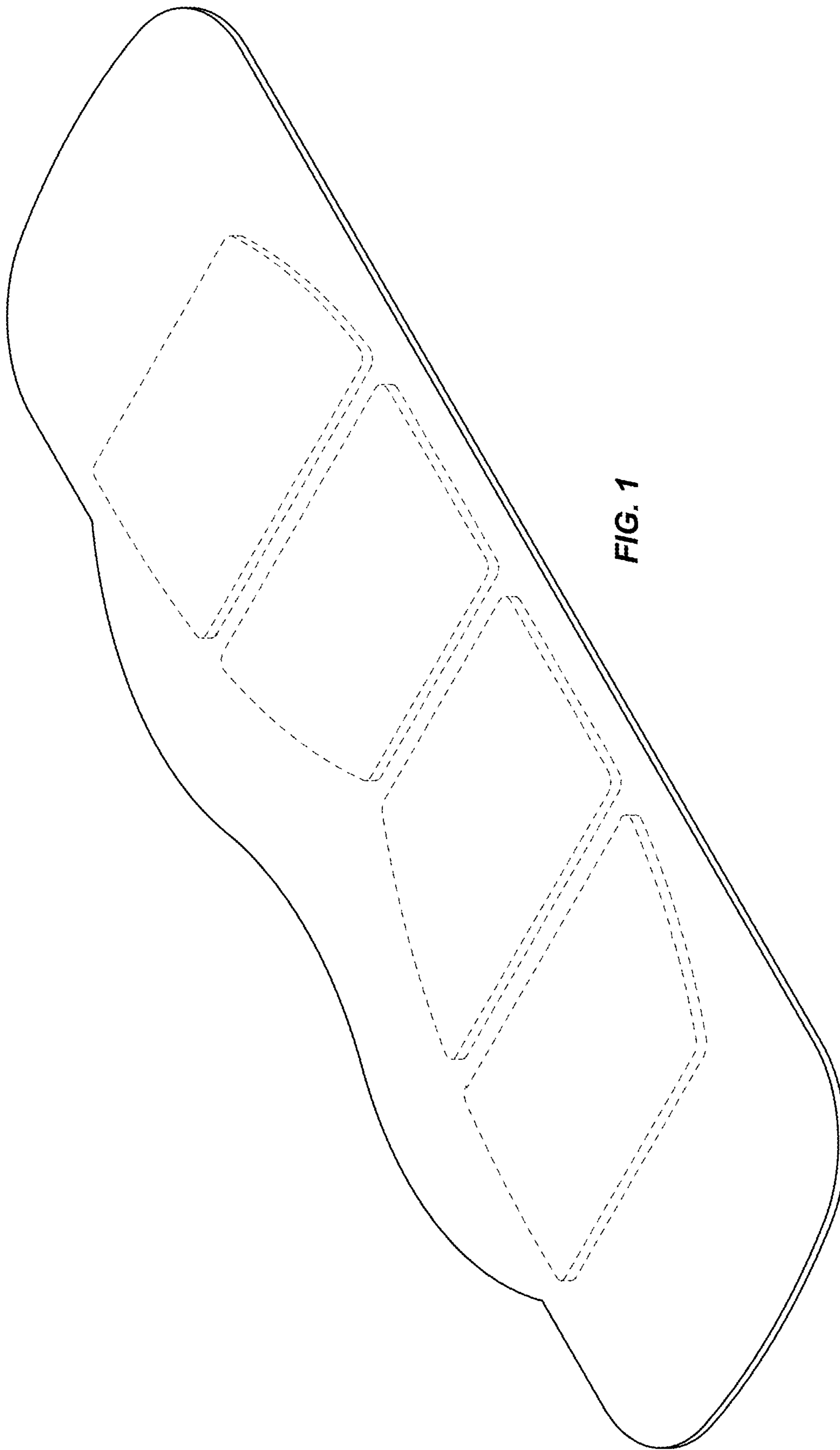

FIG. 1

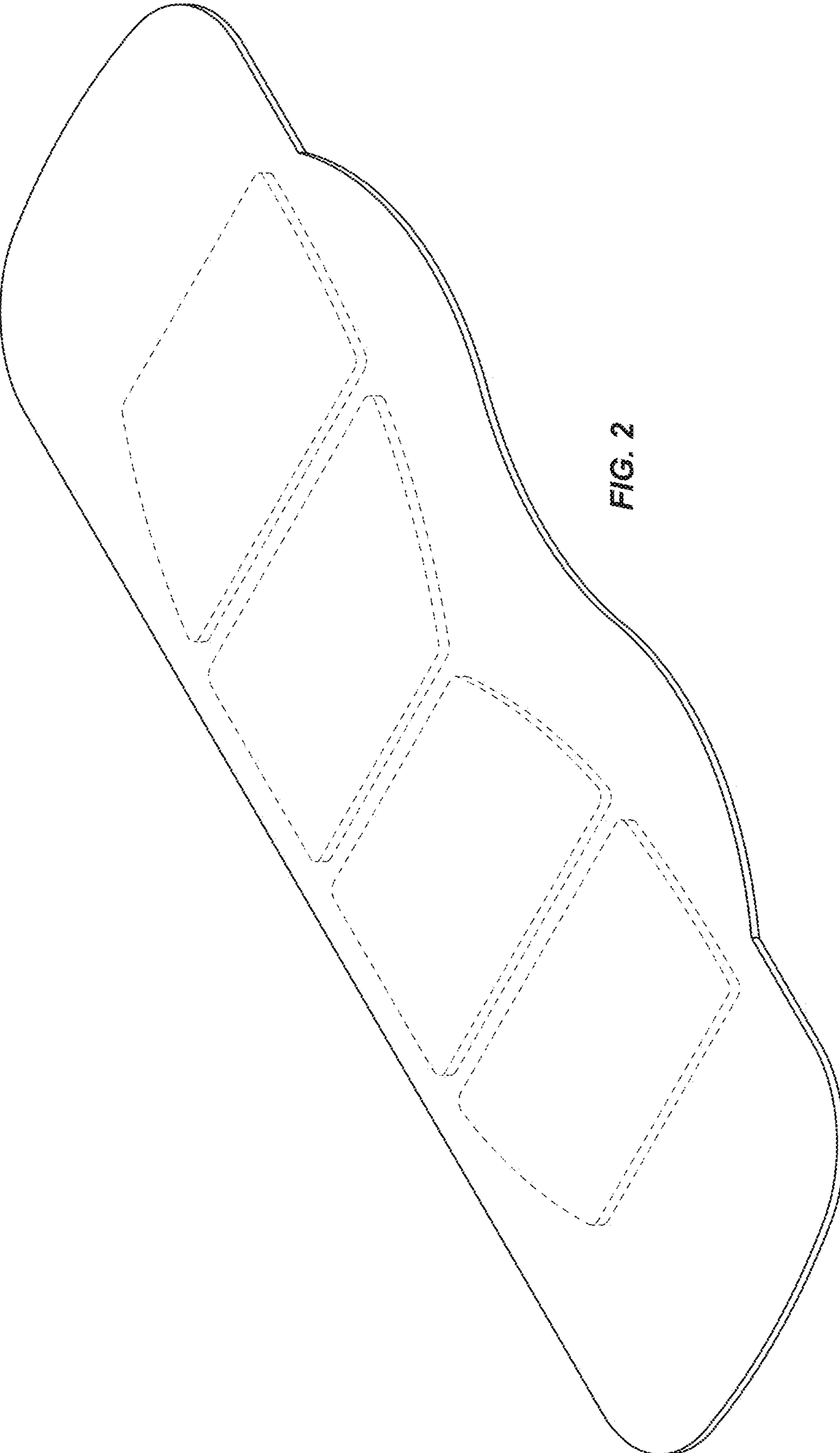

FIG. 2

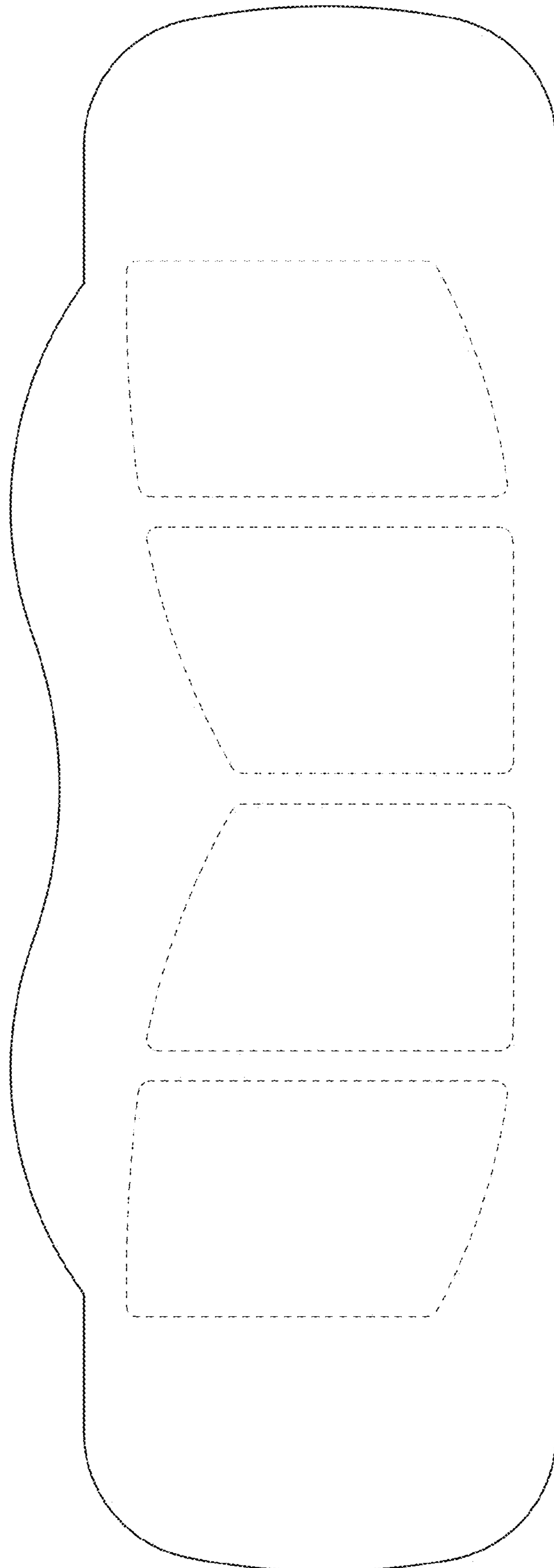

FIG. 3

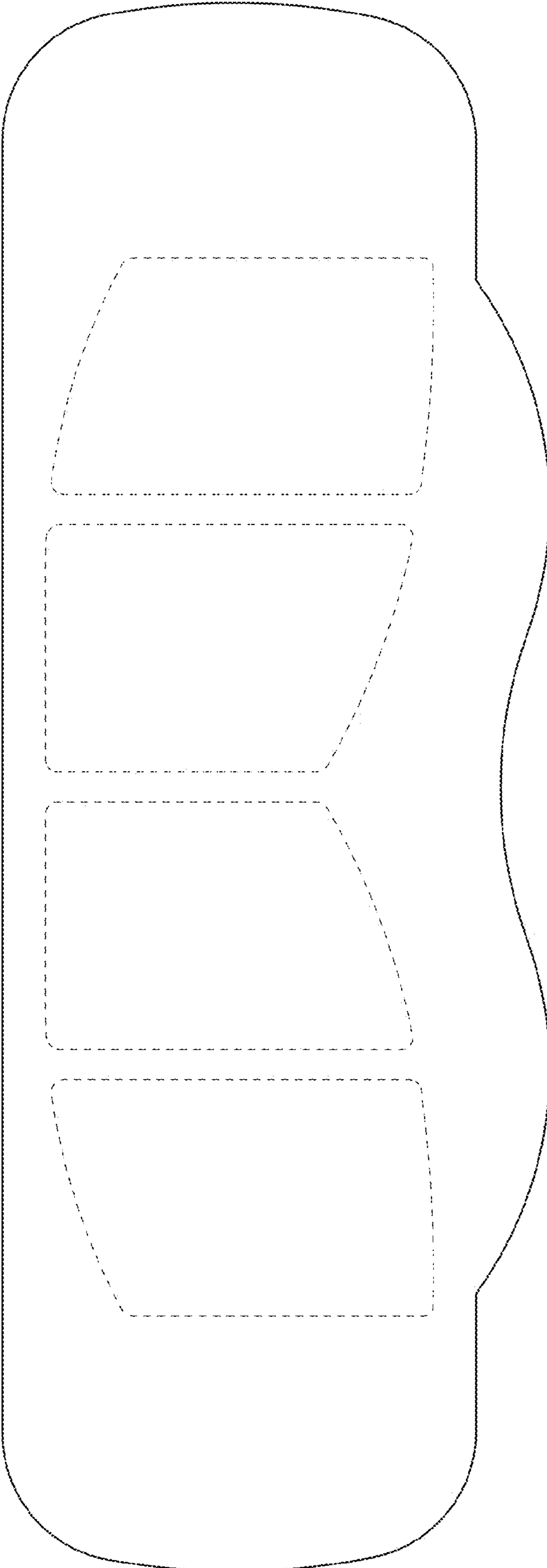

FIG. 4

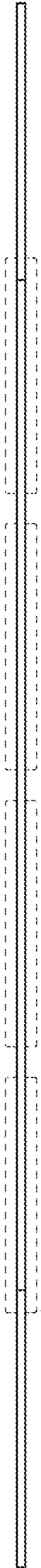

FIG. 5

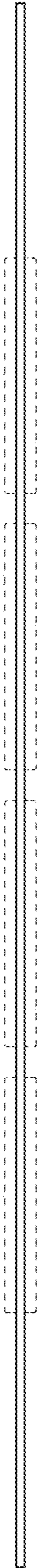

FIG. 6

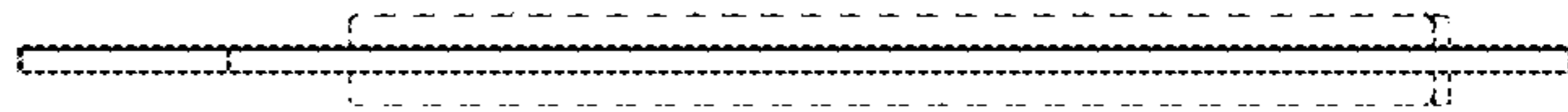

FIG. 7

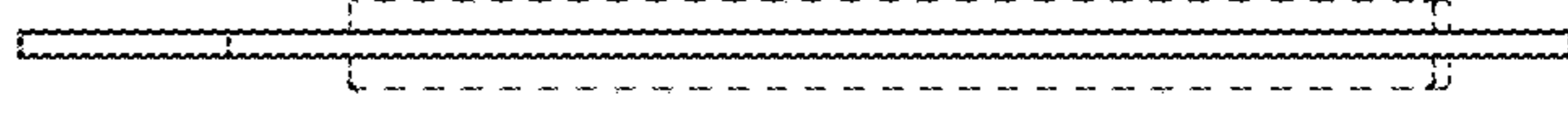

FIG. 8

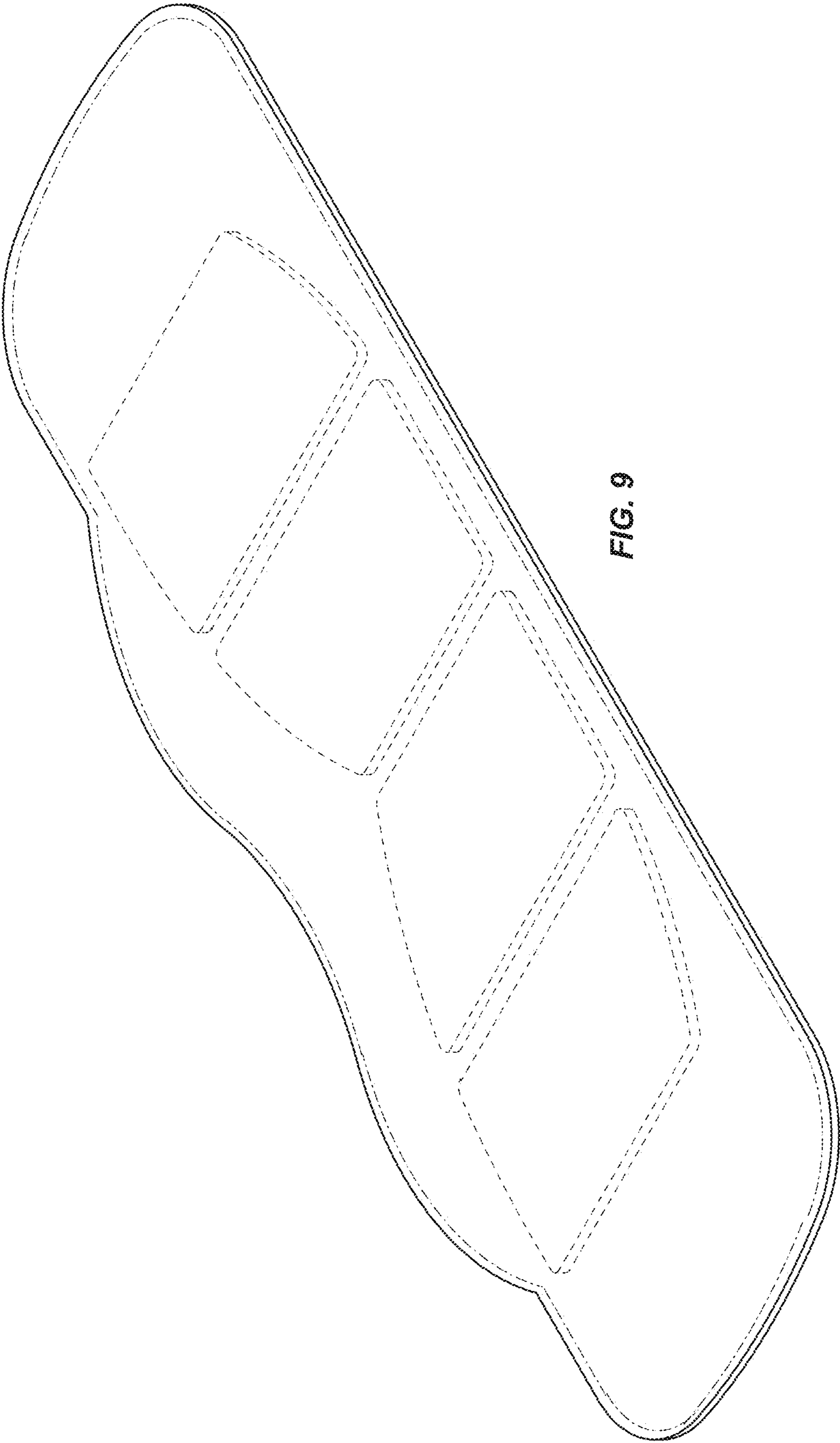

FIG. 9



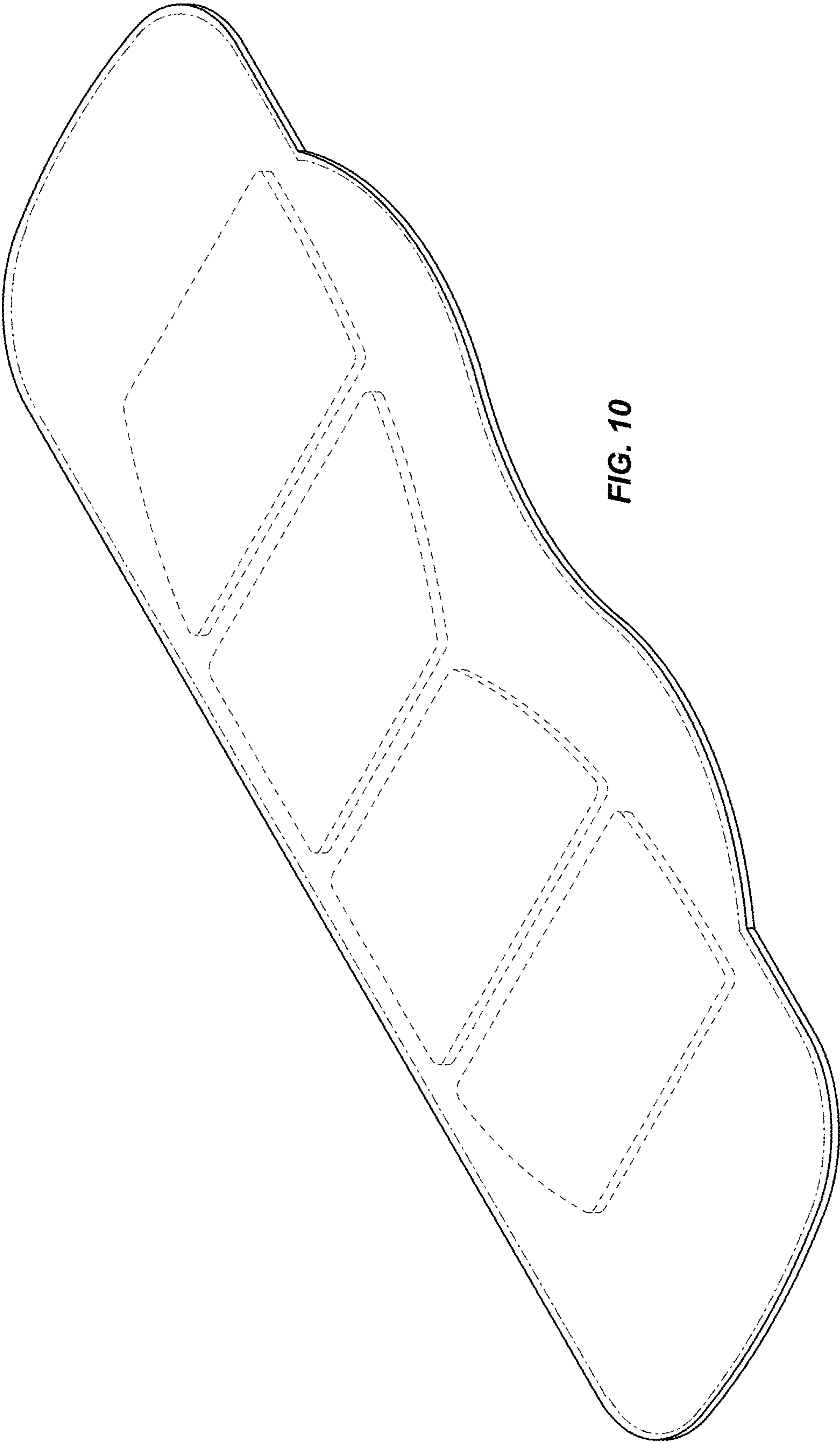

FIG. 10

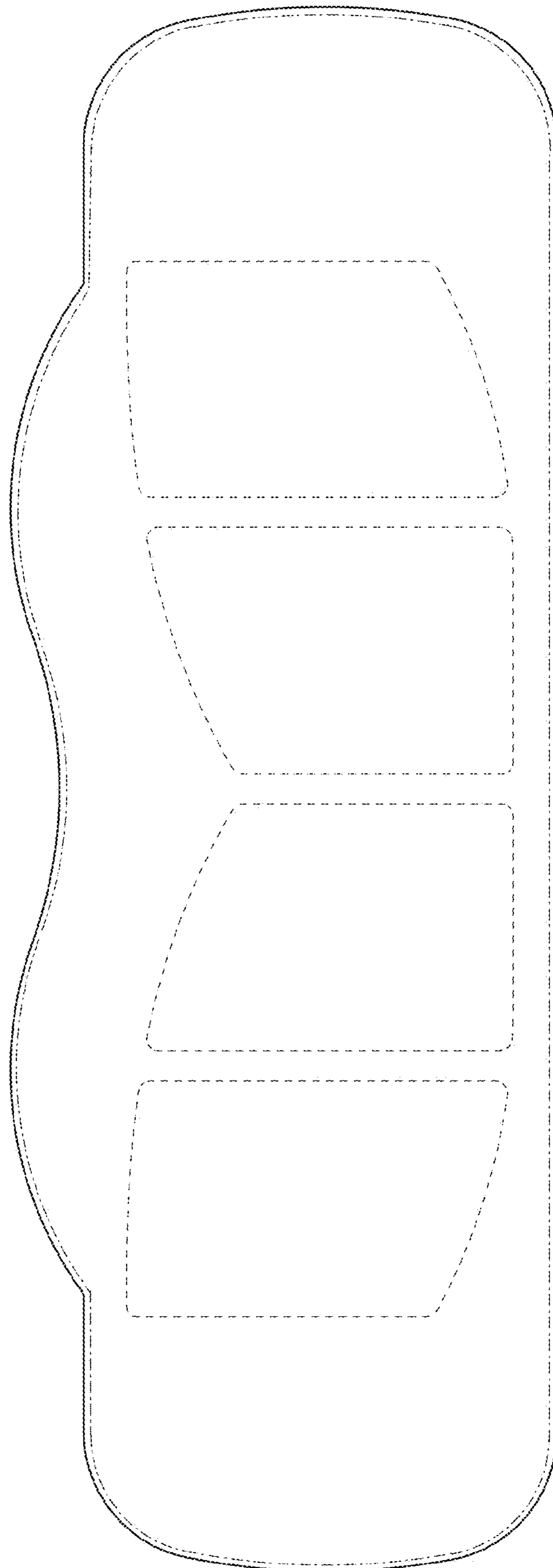

FIG. 11

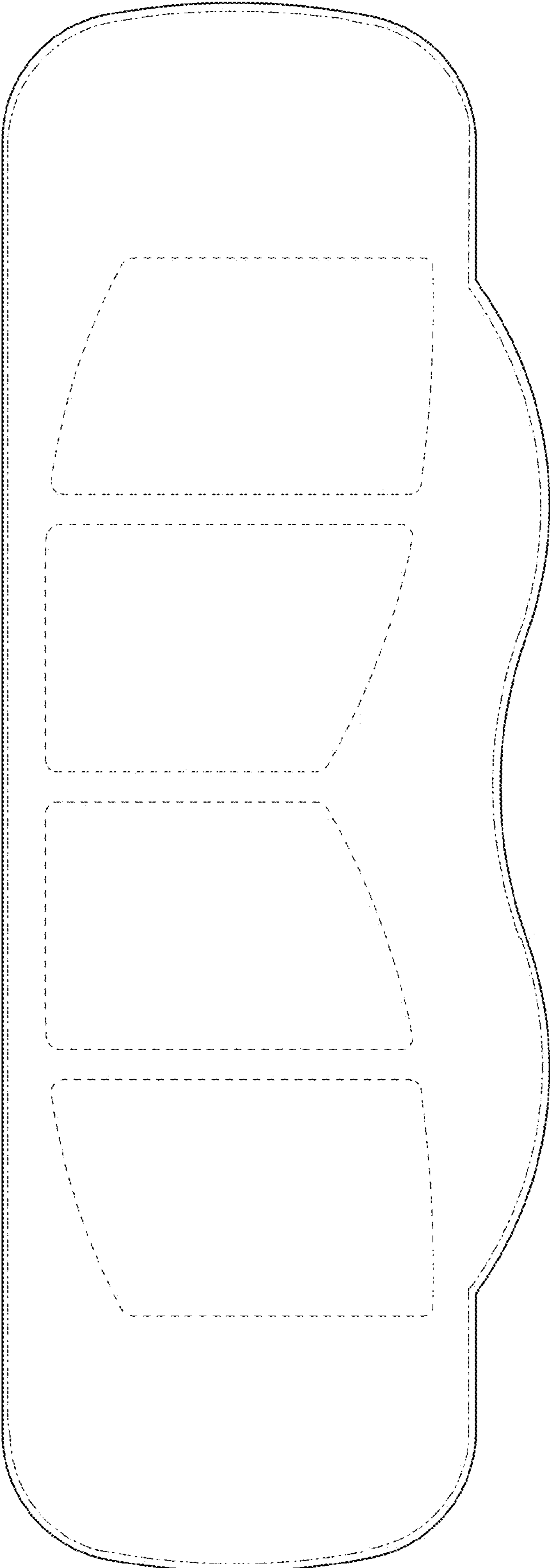

FIG. 12

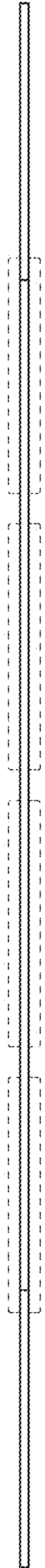

FIG. 13

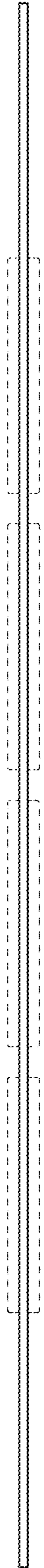

FIG. 14

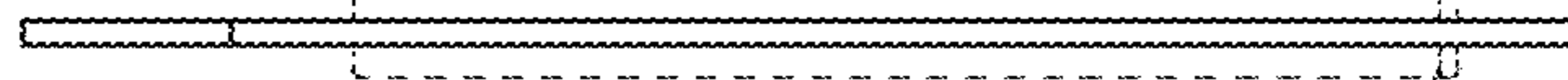

FIG. 15

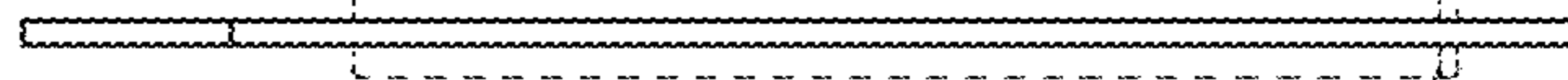

FIG. 16