

US00D899536S

(12) **United States Design Patent** (10) **Patent No.:** **US D899,536 S**  
**Endelman** (45) **Date of Patent:** **\*\* Oct. 20, 2020**

(54) **STEP BARREL EXERCISE APPARATUS**  
(71) Applicant: **Balanced Body, Inc.**, Sacramento, CA (US)  
(72) Inventor: **Ken Endelman**, Sacramento, CA (US)  
(73) Assignee: **BALANCED BODY, INC.**, Sacramento, CA (US)

D410,744 S \* 6/1999 Banister ..... D24/183  
D424,698 S \* 5/2000 Ames ..... D24/183  
D432,603 S \* 10/2000 Bullard, Jr. .... D21/662  
D445,505 S \* 7/2001 Shapiro ..... D24/183  
D447,805 S \* 9/2001 Siegal ..... D24/183  
D462,557 S \* 9/2002 Scheetz ..... D6/601  
D500,622 S \* 1/2005 Owen ..... D6/596  
D509,270 S \* 9/2005 Stangler ..... D21/686

(Continued)

(\*\*) Term: **15 Years**

(21) Appl. No.: **29/678,166**

(22) Filed: **Jan. 25, 2019**

(51) **LOC (12) Cl.** ..... **21-02**

(52) **U.S. Cl.**  
USPC ..... **D21/686**

(58) **Field of Classification Search**  
USPC ..... D21/686; D6/349, 350, 352, 353, 355,  
D6/595, 596, 601, 604; D25/65;  
D24/183  
CPC ..... A63B 21/00047; A63B 5/00; A47C 9/002  
See application file for complete search history.

(56) **References Cited**

**U.S. PATENT DOCUMENTS**

D254,029 S \* 1/1980 Barbagallo ..... 5/636  
4,210,322 A \* 7/1980 Pritchard ..... A63B 21/00047  
482/23  
D276,938 S \* 12/1984 Pedersen ..... 5/636  
D278,004 S \* 3/1985 Sigona ..... D6/361  
D285,752 S \* 9/1986 Sadow ..... 5/648  
D299,169 S \* 12/1988 Hall ..... D24/215  
D310,609 S \* 9/1990 Burkhardt ..... D6/601  
D321,562 S \* 11/1991 Ljungvall ..... 5/646  
D343,001 S \* 1/1994 Boland ..... D24/183  
D349,541 S \* 8/1994 Bertolucci ..... D21/686  
D356,156 S \* 3/1995 Boland ..... D24/183  
D366,966 S \* 2/1996 Bonaddio ..... D6/335  
D370,066 S \* 5/1996 Kennemore ..... D24/183  
D398,181 S \* 9/1998 Lange ..... D6/596  
D405,854 S \* 2/1999 Grant ..... D21/687

**OTHER PUBLICATIONS**

Youtube, "Clara Step Barrel Lite\_Clip", May 23, 2019. <https://www.youtube.com/watch?v=BU317KDt7KM>. Shown at 0:02 minute mark. (Year: 2019).\*

(Continued)

*Primary Examiner* — Cynthia Ramirez  
*Assistant Examiner* — Michael A Maharajh  
(74) *Attorney, Agent, or Firm* — Greenberg Traurig, LLP

(57) **CLAIM**

The ornamental design for a step barrel exercise apparatus, as shown and described herein.

**DESCRIPTION**

FIG. 1 is a perspective view of a step barrel exercise apparatus showing my new design;  
FIG. 2 is a right side elevational view thereof;  
FIG. 3 is a left side elevational view thereof;  
FIG. 4 is a front view thereof;  
FIG. 5 is a rear view thereof;  
FIG. 6 is a top plan view thereof;  
FIG. 7 is a bottom plan view thereof; and,  
FIG. 8 is a cross-sectional view taken along line 8-8 of FIG. 6 thereof.

The broken lines in the drawings are for the purpose of illustrating portions of the step barrel exercise apparatus, which form no part of the claimed design.

**1 Claim, 7 Drawing Sheets**

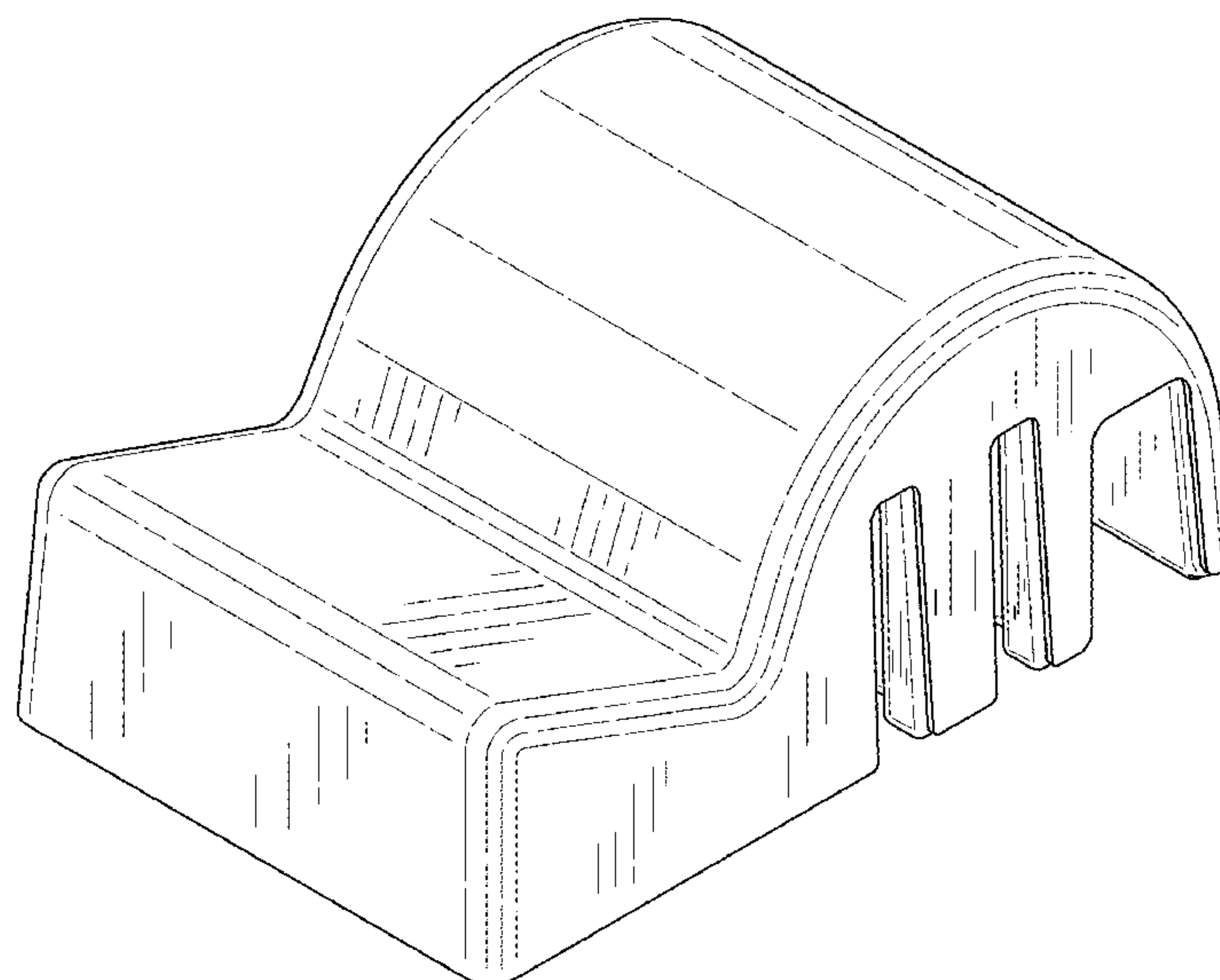

(56)

References Cited

U.S. PATENT DOCUMENTS

D523,494 S \* 6/2006 Van Straaten ..... D21/662  
 D523,913 S \* 6/2006 Van Straaten ..... D21/662  
 D526,369 S \* 8/2006 Van Straaten ..... D21/662  
 D531,315 S \* 10/2006 Caudra ..... D24/183  
 D543,064 S \* 5/2007 Hale ..... D6/596  
 D555,741 S \* 11/2007 Wachtfogel ..... D21/662  
 D565,131 S \* 3/2008 Decker ..... D21/686  
 D566,845 S \* 4/2008 Daly ..... D24/183  
 D571,871 S \* 6/2008 Backstrand ..... D21/686  
 D581,715 S \* 12/2008 Scheuch ..... D6/601  
 D618,944 S \* 7/2010 Rothstein ..... D6/601  
 D634,961 S \* 3/2011 Lowery ..... D6/601  
 D639,876 S \* 6/2011 Tsou ..... D21/662  
 D642,694 S \* 8/2011 Sharps ..... D24/183  
 D649,253 S \* 11/2011 Held ..... D24/183  
 D663,426 S \* 7/2012 Davis, III ..... D24/183  
 D664,256 S \* 7/2012 Dennewald ..... D24/183  
 D665,503 S \* 8/2012 Dennewald ..... D24/183  
 D675,267 S \* 1/2013 Jamison, Jr. .... D21/686  
 RE43,981 E 2/2013 Endelman  
 D681,994 S \* 5/2013 Morgan, II ..... D6/601  
 D691,222 S \* 10/2013 Sterios ..... D21/686  
 D695,548 S \* 12/2013 Johnson ..... D6/601  
 D695,857 S \* 12/2013 Sterios ..... D21/686  
 D696,046 S \* 12/2013 Marinkovic ..... D6/601

D701,582 S \* 3/2014 Sterios ..... D21/686  
 D707,312 S \* 6/2014 Sterios ..... D21/686  
 D758,099 S \* 6/2016 Pham ..... D6/601  
 D764,062 S \* 8/2016 Dennewald ..... A47G 9/1081  
 D24/183  
 D767,148 S \* 9/2016 Perreault ..... D24/183  
 D781,429 S \* 3/2017 Westdyk ..... D24/190  
 D789,107 S \* 6/2017 Thibault ..... D25/65  
 D802,690 S \* 11/2017 Laszlo ..... D21/686  
 D808,532 S \* 1/2018 Richey ..... D24/183  
 D821,780 S \* 7/2018 Strandberg ..... D6/596  
 D859,664 S \* 9/2019 Dennewald ..... D24/183  
 D864,318 S \* 10/2019 Szonyi ..... D21/686  
 D880,628 S \* 4/2020 McHenry ..... D21/686  
 2007/0117695 A1 \* 5/2007 Endelman ..... A63B 21/4037  
 482/140  
 2008/0004167 A1 \* 1/2008 Endelman ..... A63B 21/00047  
 482/142  
 2019/0374813 A1 \* 12/2019 Sotter ..... A63B 1/00

OTHER PUBLICATIONS

Pilates, "Clara Step Barrel Lite", Jun. 15, 2020. <https://www.pilates.com/store/pilates-equipment/arcs-barrels/barrels-arcs/clara-lite>. Shown on p. 1. (Year: 2020).\*

\* cited by examiner

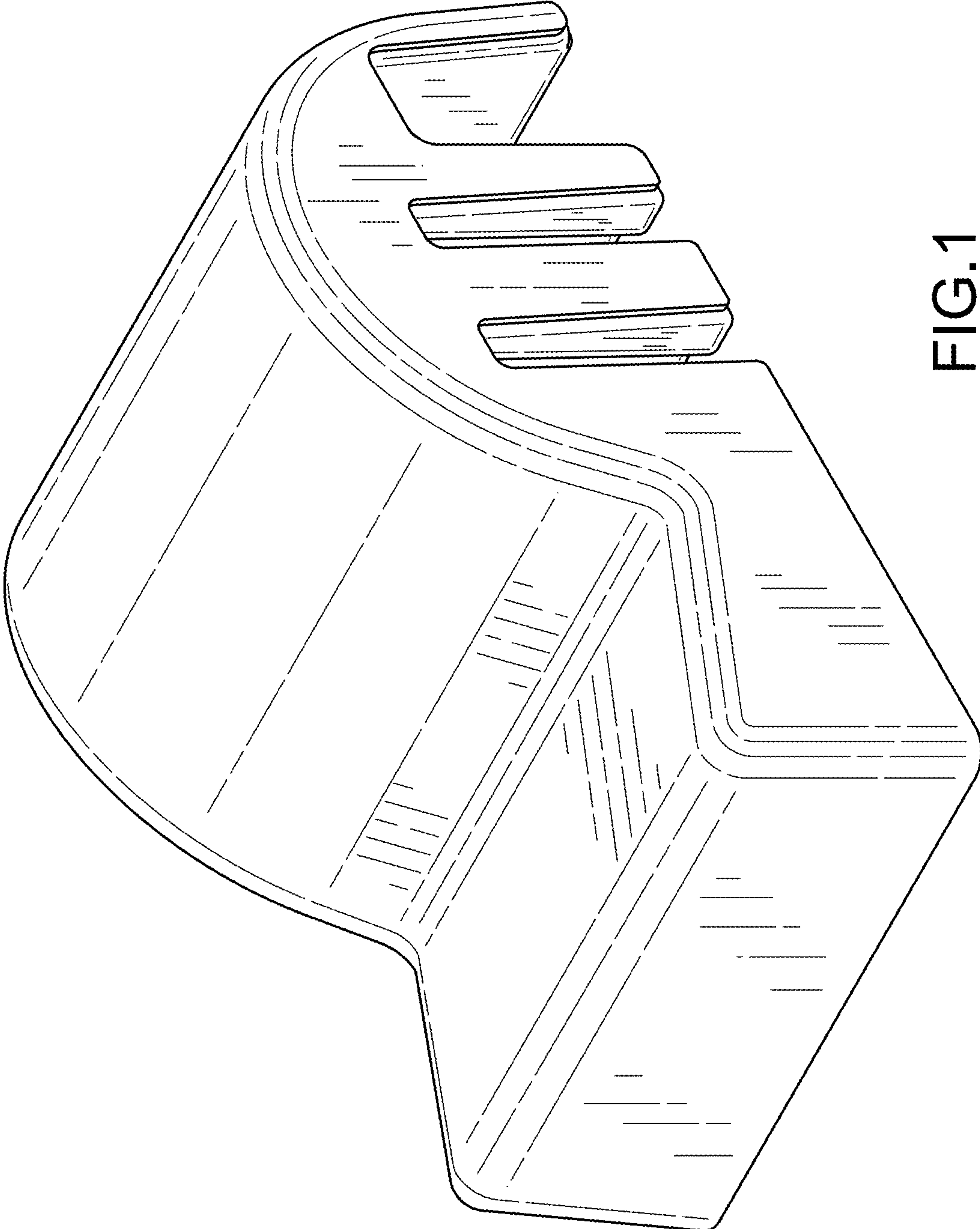

FIG.1

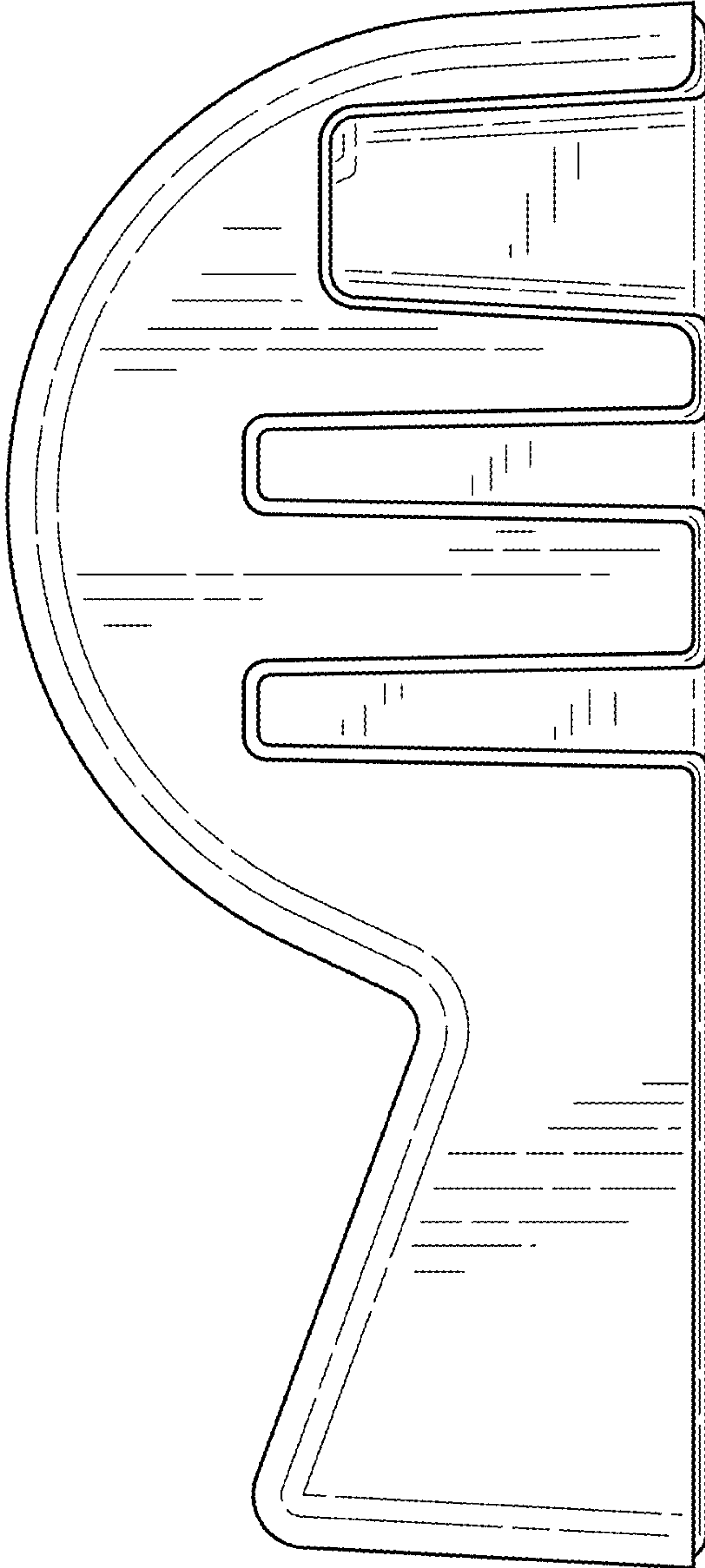

FIG.2



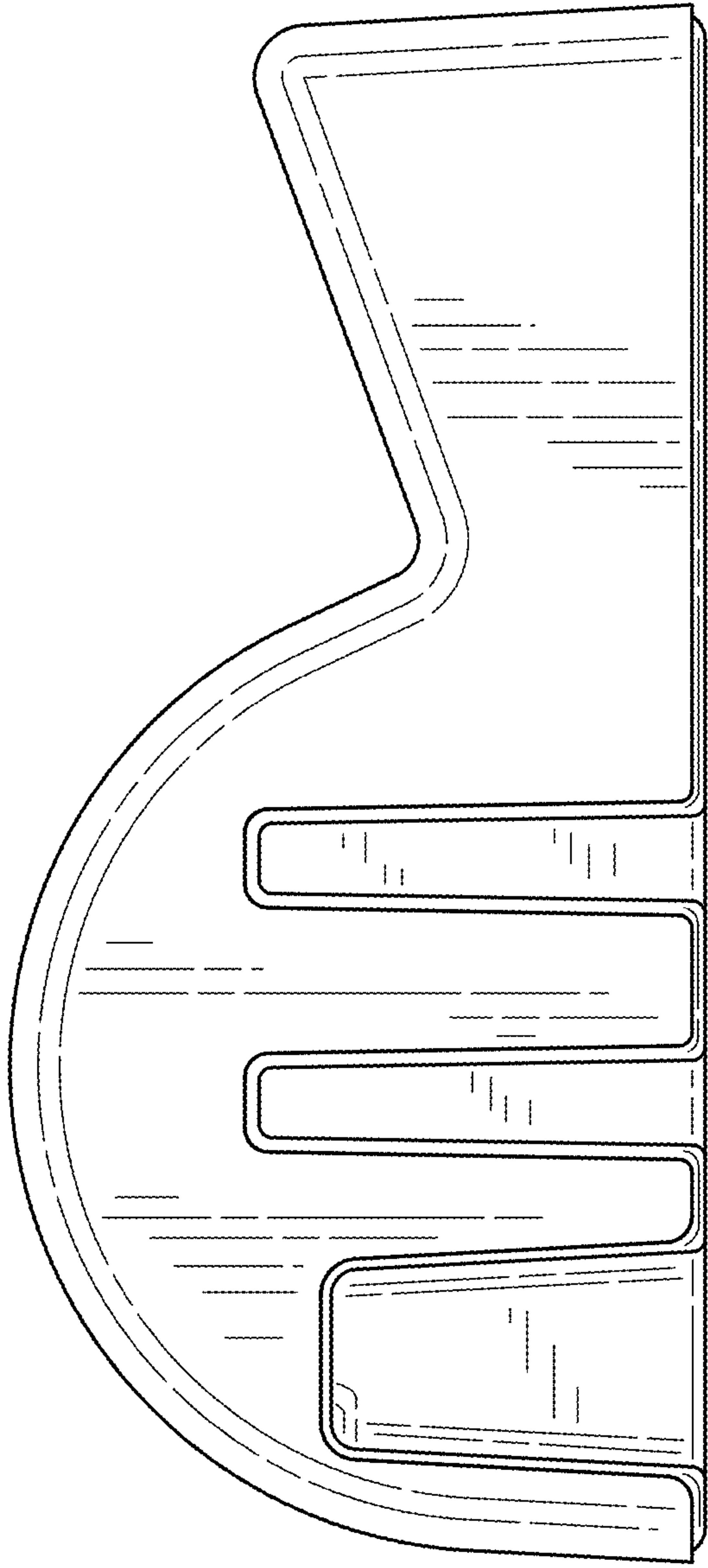

FIG.3

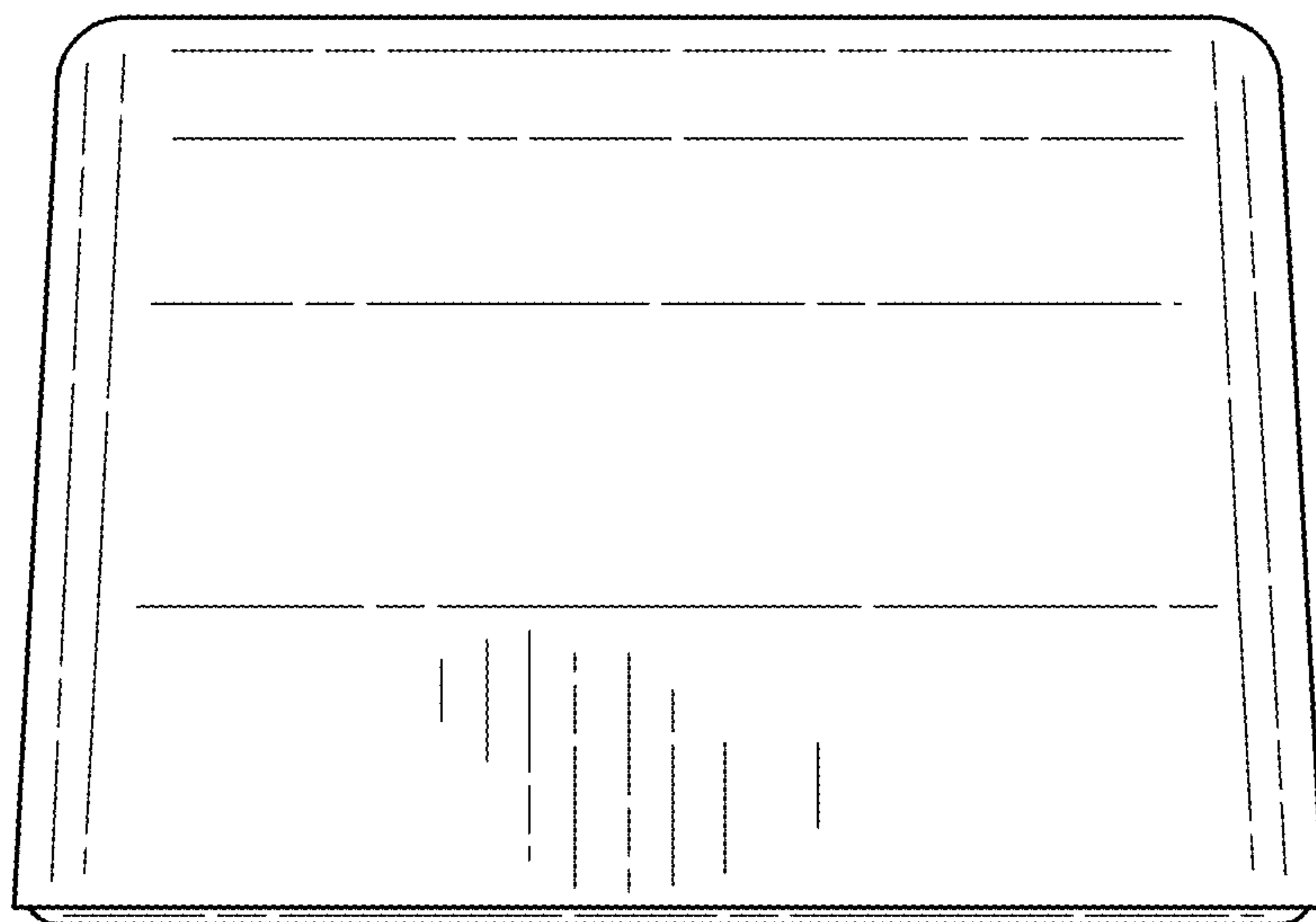

FIG. 4

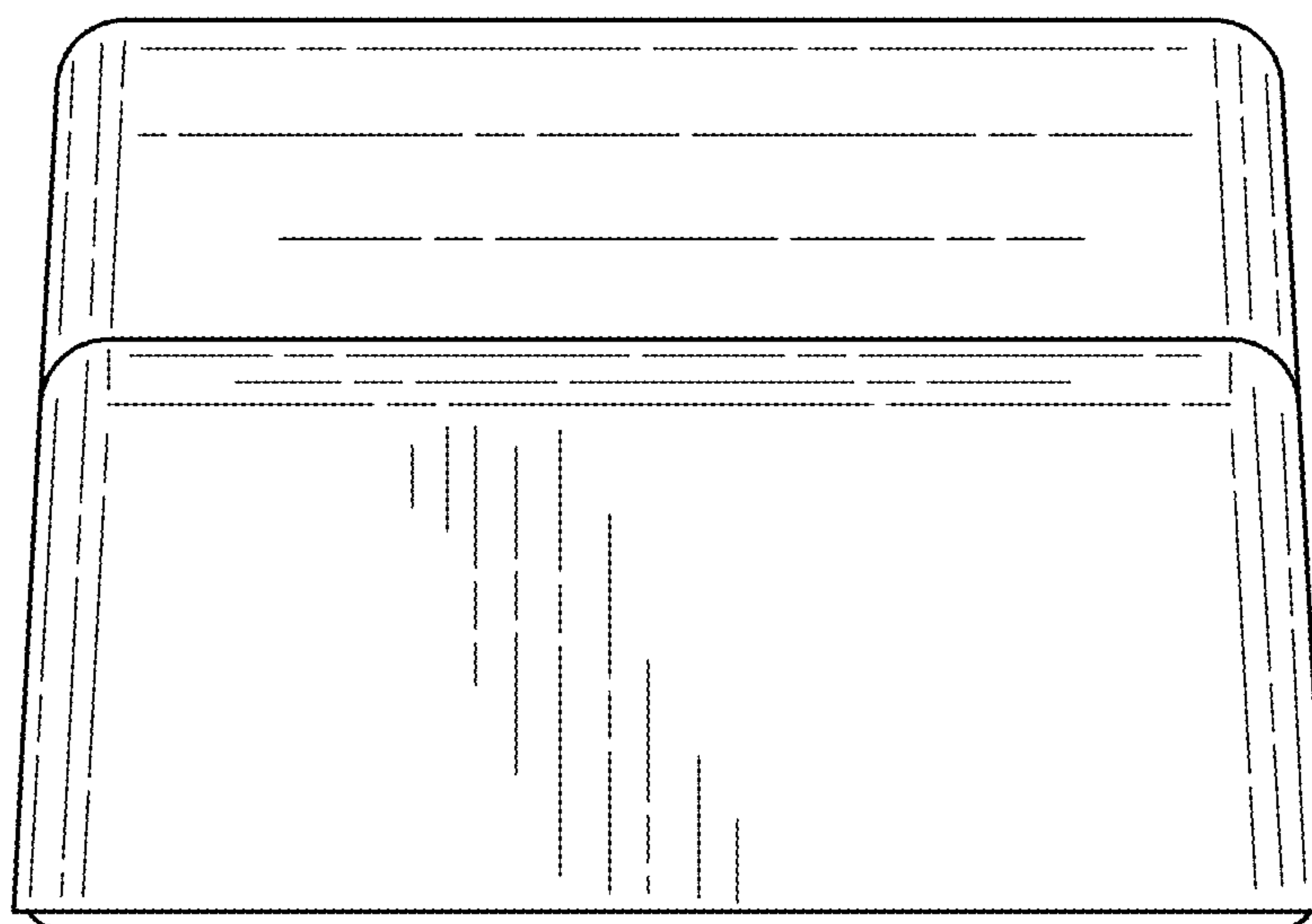

FIG. 5

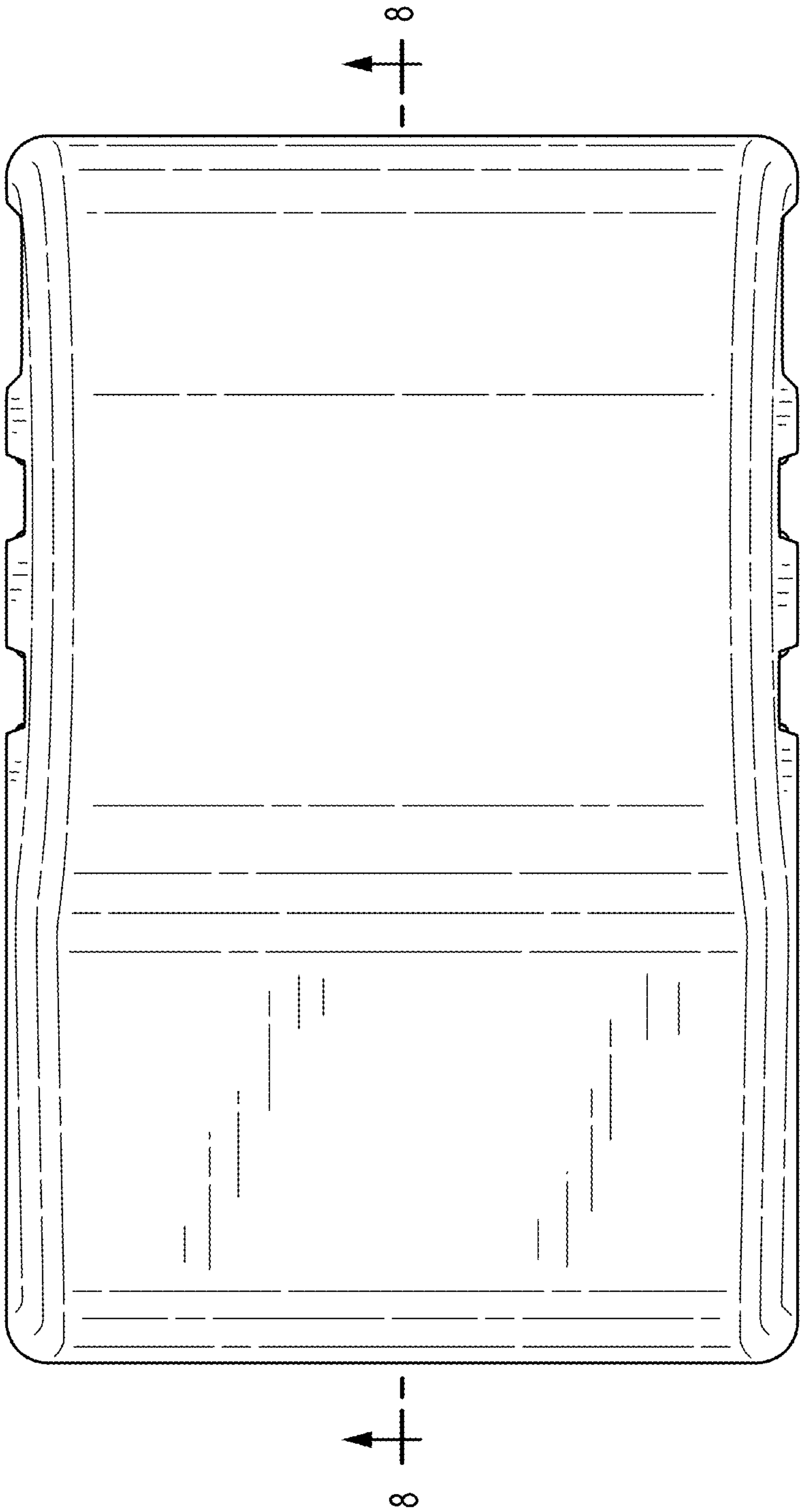

FIG.6

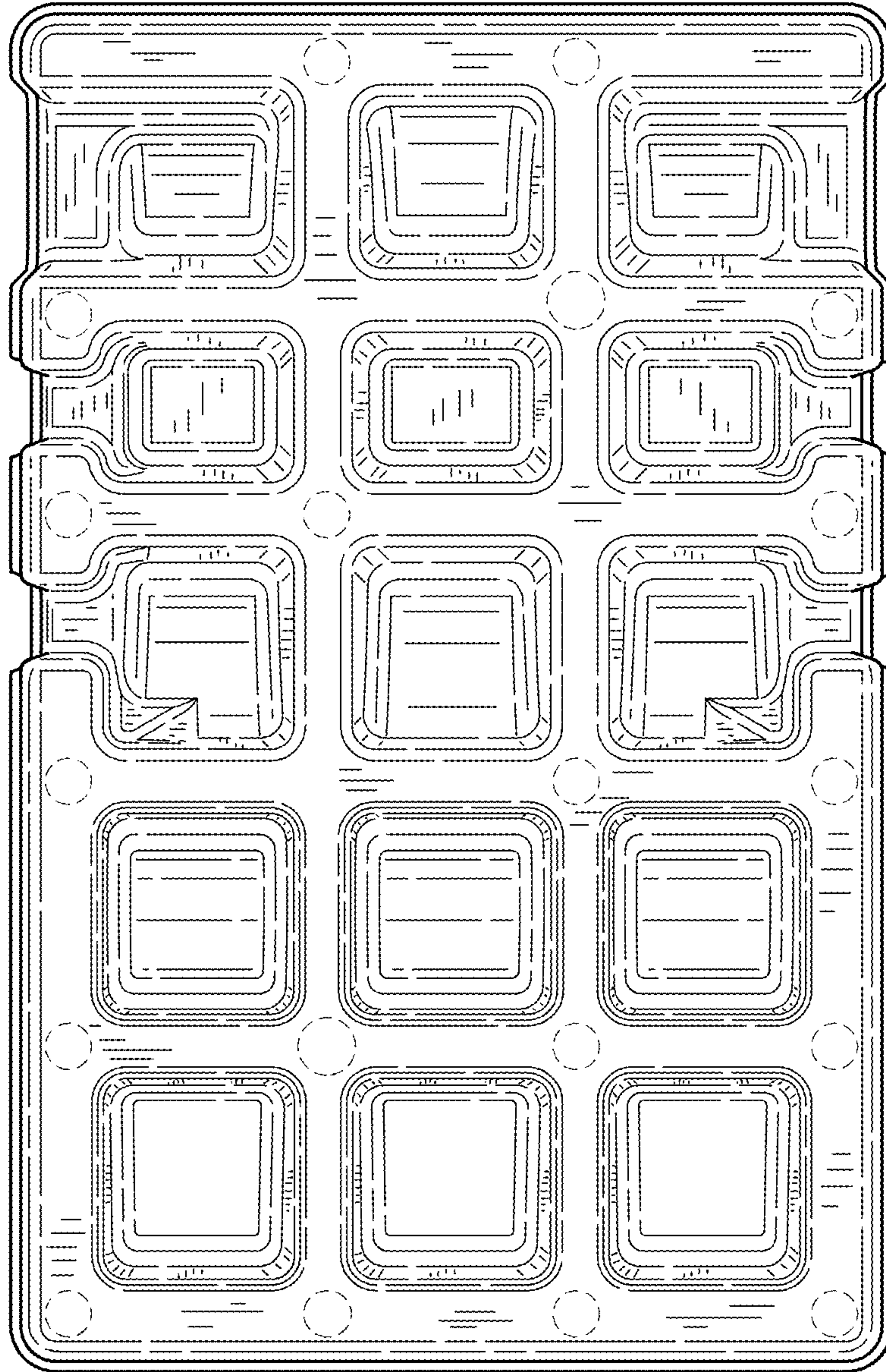

FIG.7



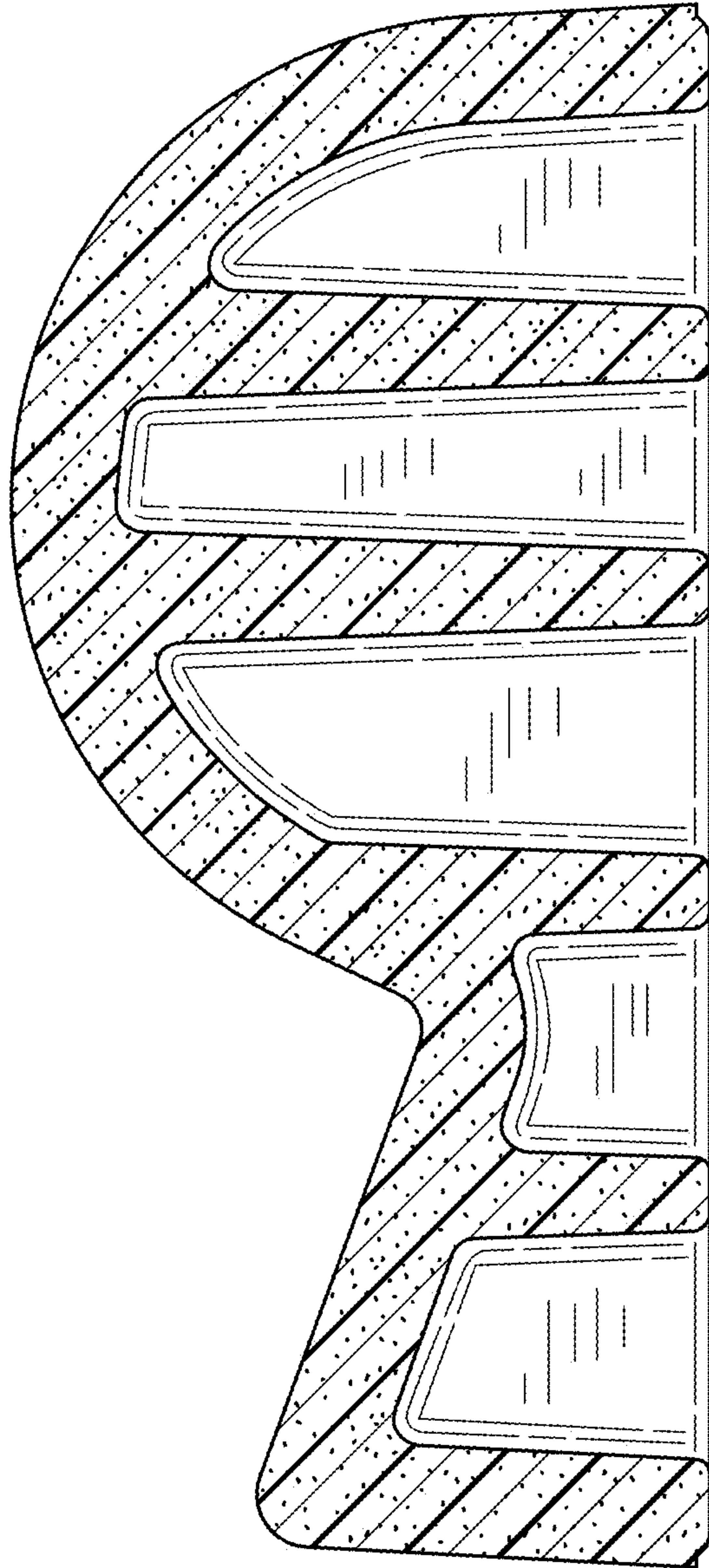

FIG.8