

US00D899520S

(12) **United States Design Patent** (10) **Patent No.:** **US D899,520 S**
Zou (45) **Date of Patent:** **** Oct. 20, 2020**

(54) **HANDWRITING BOARD**
(71) Applicant: **Shenzhen Ugee Technology Co., Ltd.**,
Shenzhen (CN)
(72) Inventor: **Xinhang Zou**, Shenzhen (CN)
(73) Assignee: **Hanwang Ugee Technology Co., Ltd.**,
Shenzhen, Guangdong Province (CN)
(**) Term: **15 Years**
(21) Appl. No.: **29/677,546**
(22) Filed: **Jan. 22, 2019**
(30) **Foreign Application Priority Data**

Nov. 7, 2018 (CN) 2018 3 0627957

(51) **LOC (12) Cl.** **19-06**

(52) **U.S. Cl.**
USPC **D19/113**

(58) **Field of Classification Search**
USPC D19/113, 114, 81, 88, 26-33; D6/310,
D6/311; D7/698; D20/10, 19, 39, 40,
D20/41, 42; D14/341, 440; D13/174
CPC B43L 1/00; B43L 1/008; B43L 1/08; B43L
1/04; B43L 5/00; B43L 5/02; B43L
5/002; B43L 5/005; B43L 5/007; B42F
9/001; B42F 9/002; B42F 9/004; B42F
9/005; B42F 9/007; B42F 9/008; G09F
15/00; G09F 15/0006; G09F 15/0012;
G09F 1/12; G09F 7/00; B44D 3/18;
B44D 3/185

See application file for complete search history.

(56) **References Cited**

U.S. PATENT DOCUMENTS

D183,396 S * 8/1958 Koch D13/174
D307,743 S * 5/1990 Pierce D13/170
D308,045 S * 5/1990 Counts D13/170
D384,646 S * 10/1997 Miller D13/170

D415,472 S * 10/1999 Kelso D13/170
5,998,747 A * 12/1999 Kelso H01H 23/148
174/66
D489,718 S * 5/2004 Kataoka D14/346
D500,990 S * 1/2005 Gorman D13/174
D534,215 S * 12/2006 Nakata D19/113
D535,628 S * 1/2007 Fort D13/170
D536,213 S * 2/2007 Schuler D7/392.1

(Continued)

Primary Examiner — Elizabeth A. Albert

(74) *Attorney, Agent, or Firm* — Stinson LLP

(57) **CLAIM**

The ornamental design for a handwriting board, as shown and described.

DESCRIPTION

FIG. 1 is a front view of a handwriting board showing my new design;
FIG. 2 is a rear view thereof;
FIG. 3 is a left-side view thereof;
FIG. 4 is a right-side view thereof;
FIG. 5 is a top view thereof;
FIG. 6 is a bottom view thereof;
FIG. 7 is a front perspective view thereof;
FIG. 8 is an enlarged view of the feature 8 in FIG. 1 shown without the remainder of the handwriting board for convenience;
FIG. 9 is an enlarged view of the feature 9 in FIG. 5 shown without the remainder of the handwriting board for convenience;
FIG. 10 is an enlarged view of the feature 10 in FIG. 6 shown without the remainder of the handwriting board for convenience; and,
FIG. 11 is an enlarged view of the feature 11 in FIG. 7 shown without the remainder of the handwriting board for convenience.
The broken lines in the figures are included for the purpose of showing portions of the-handwriting board that form no part of the claimed design.

1 Claim, 11 Drawing Sheets

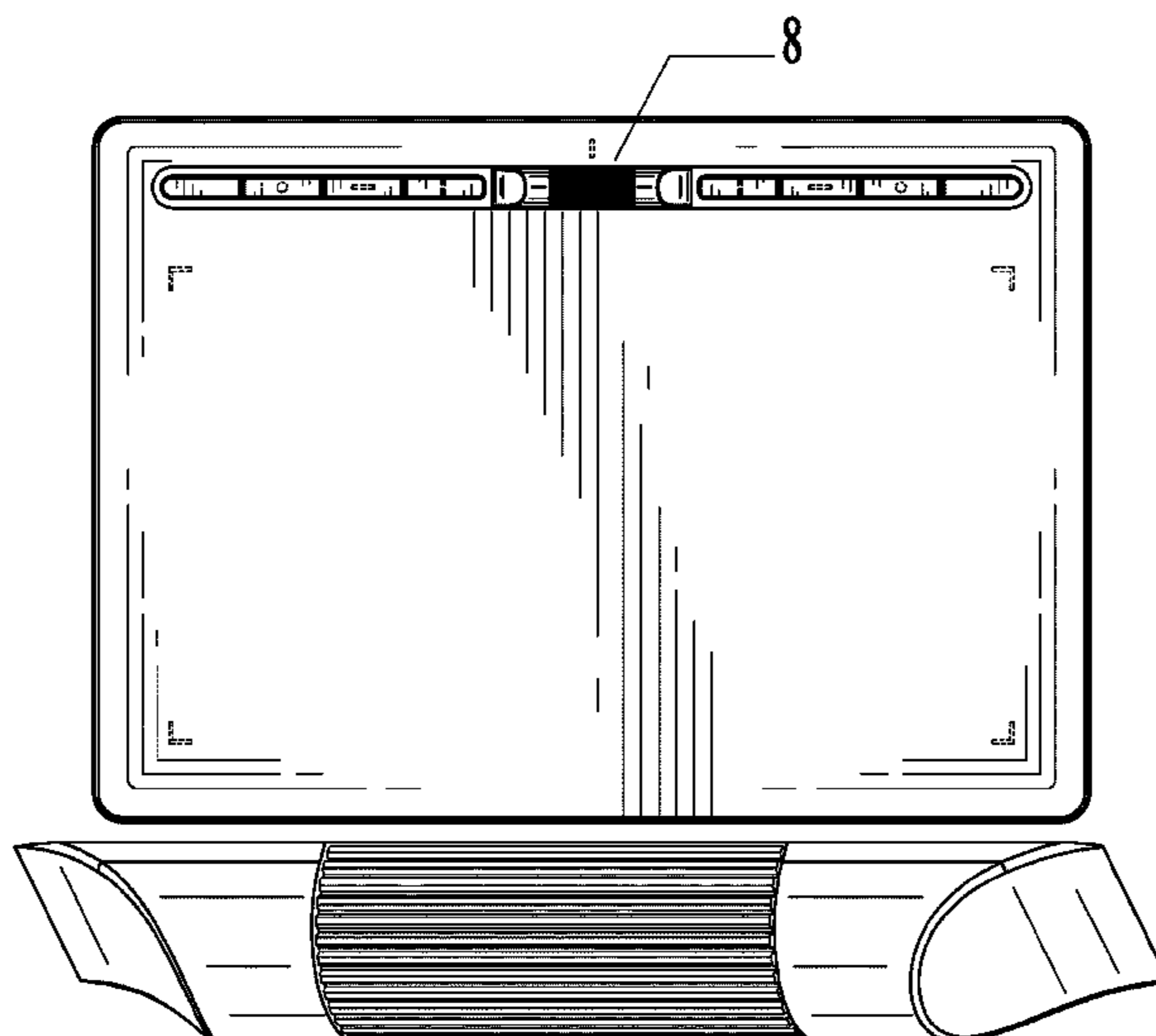

(56)

References Cited

U.S. PATENT DOCUMENTS

D572,667 S * 7/2008 Mayo D13/170
D605,158 S * 12/2009 Hung D14/138 G
D624,882 S * 10/2010 Altonen D13/171
D638,396 S * 5/2011 Finnegan D14/203.3
D640,992 S * 7/2011 Margolin D13/162
D645,001 S * 9/2011 Margolin D13/162
D645,435 S * 9/2011 Kim D14/138 G
D653,251 S * 1/2012 Leung D14/341
D658,591 S * 5/2012 Margolin D13/162
D670,287 S * 11/2012 Shimizu D14/341
D689,856 S * 9/2013 Shen D14/341
D734,179 S * 7/2015 Golden D10/50
D735,717 S * 8/2015 Lam D14/341
D761,619 S * 7/2016 Seiders D7/392.1
D784,274 S * 4/2017 Gage D13/171
D792,859 S * 7/2017 Gage D13/171
D793,349 S * 8/2017 Gage D13/171
D807,348 S * 1/2018 Wang D14/341
D815,893 S * 4/2018 Seiders D7/396.2
D820,796 S * 6/2018 Gage D13/174
D821,336 S * 6/2018 Gage D13/174
D824,383 S * 7/2018 Wall D14/341
D845,914 S * 4/2019 Gage D13/171
D852,192 S * 6/2019 Mitchell D14/389
D856,943 S * 8/2019 Gage D13/171
D859,397 S * 9/2019 Akana D14/341
D866,890 S * 11/2019 Kim D32/31
D876,435 S * 2/2020 Mitchell D14/389
D878,363 S * 3/2020 Zhai D14/341

* cited by examiner

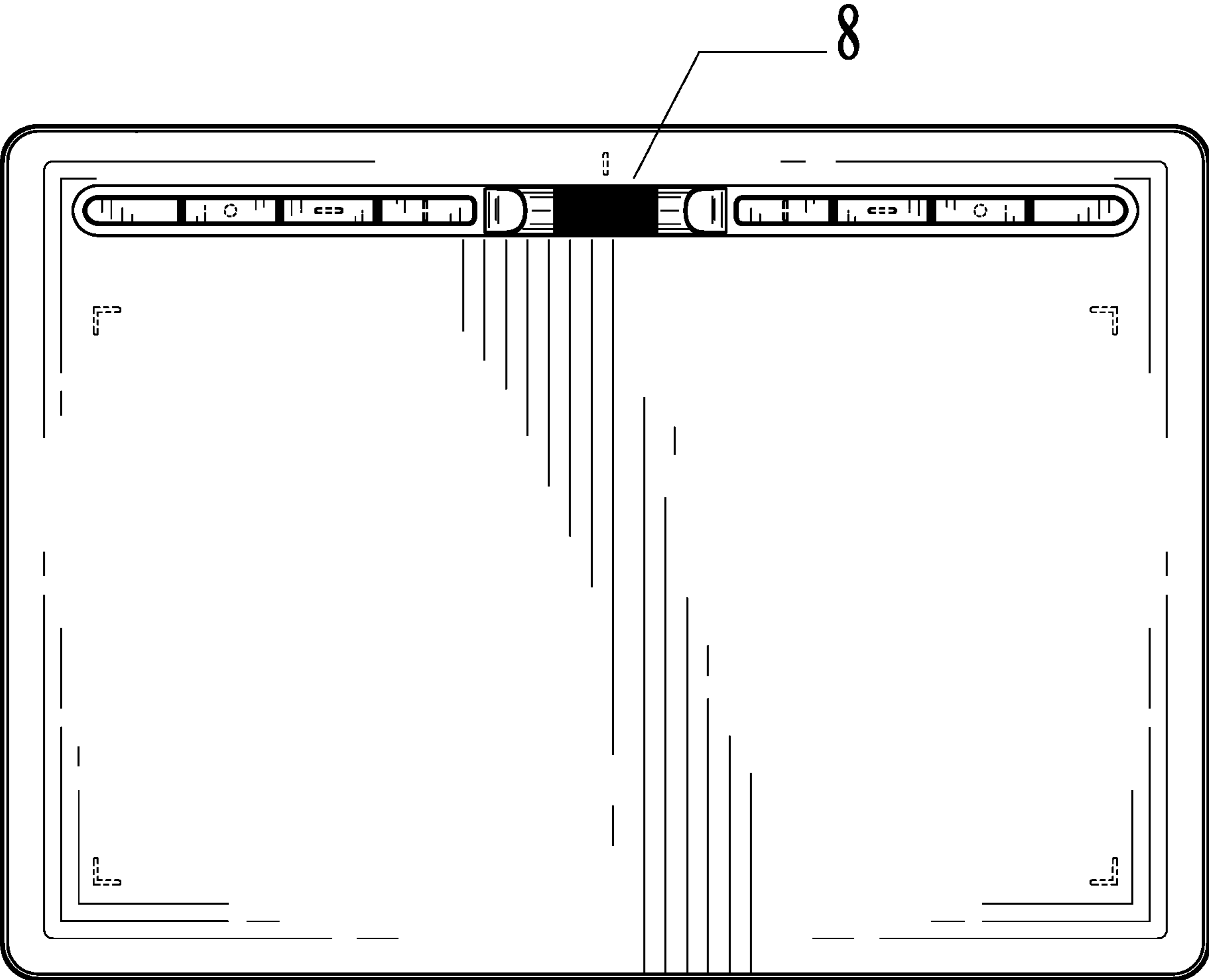

FIG. 1

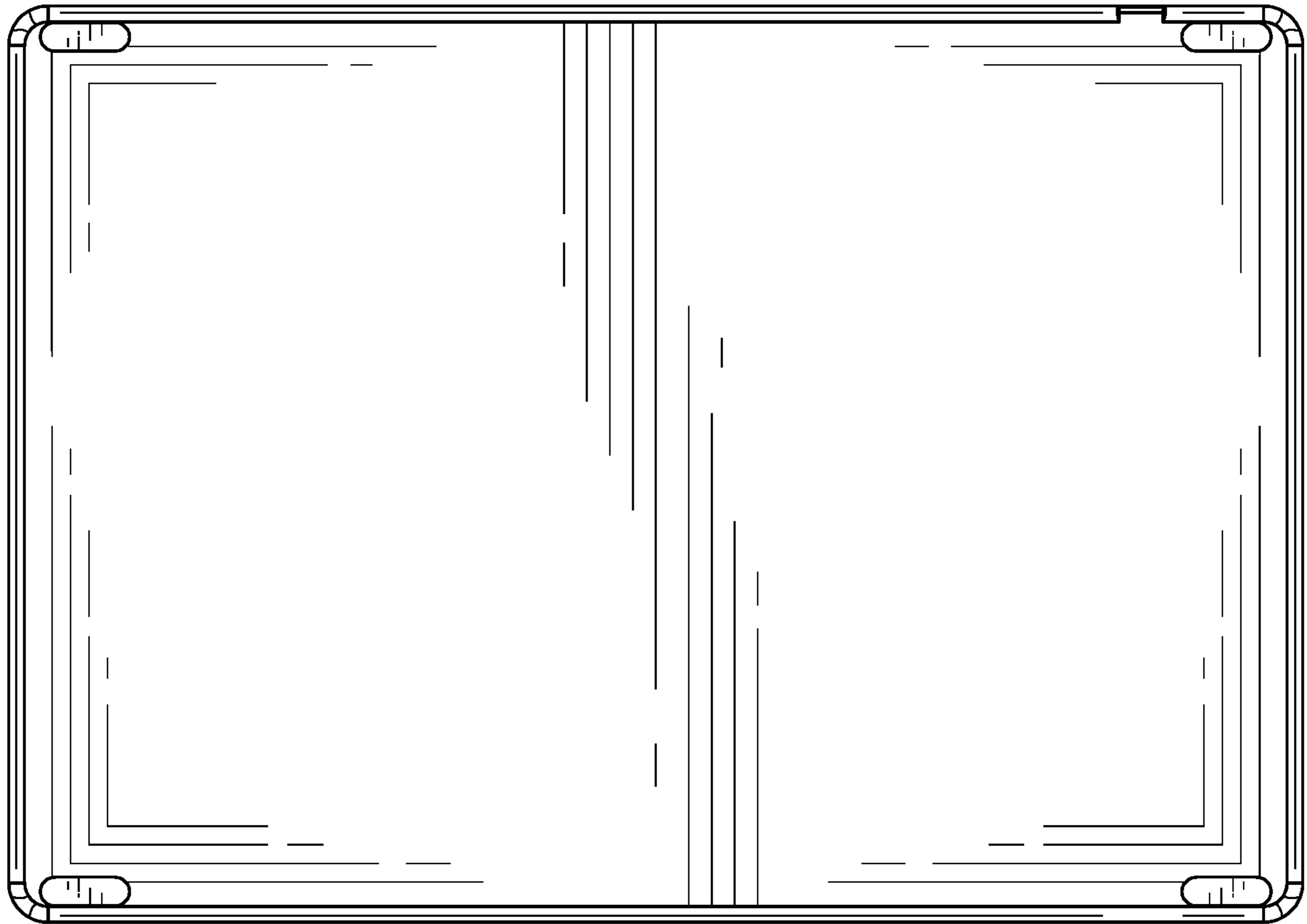

FIG. 2



FIG. 3



FIG. 4

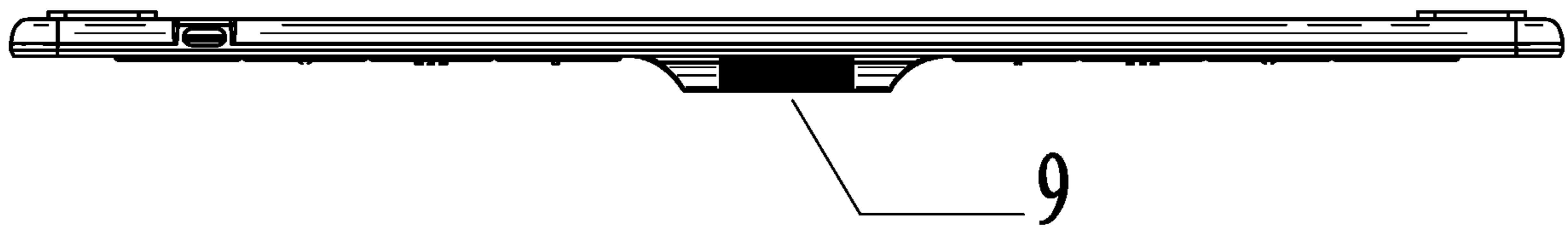

FIG. 5

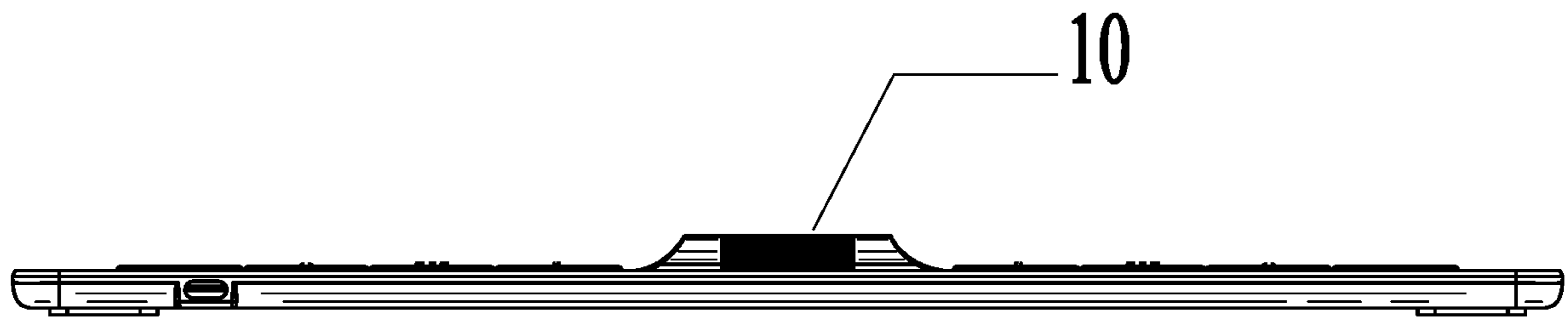

FIG. 6

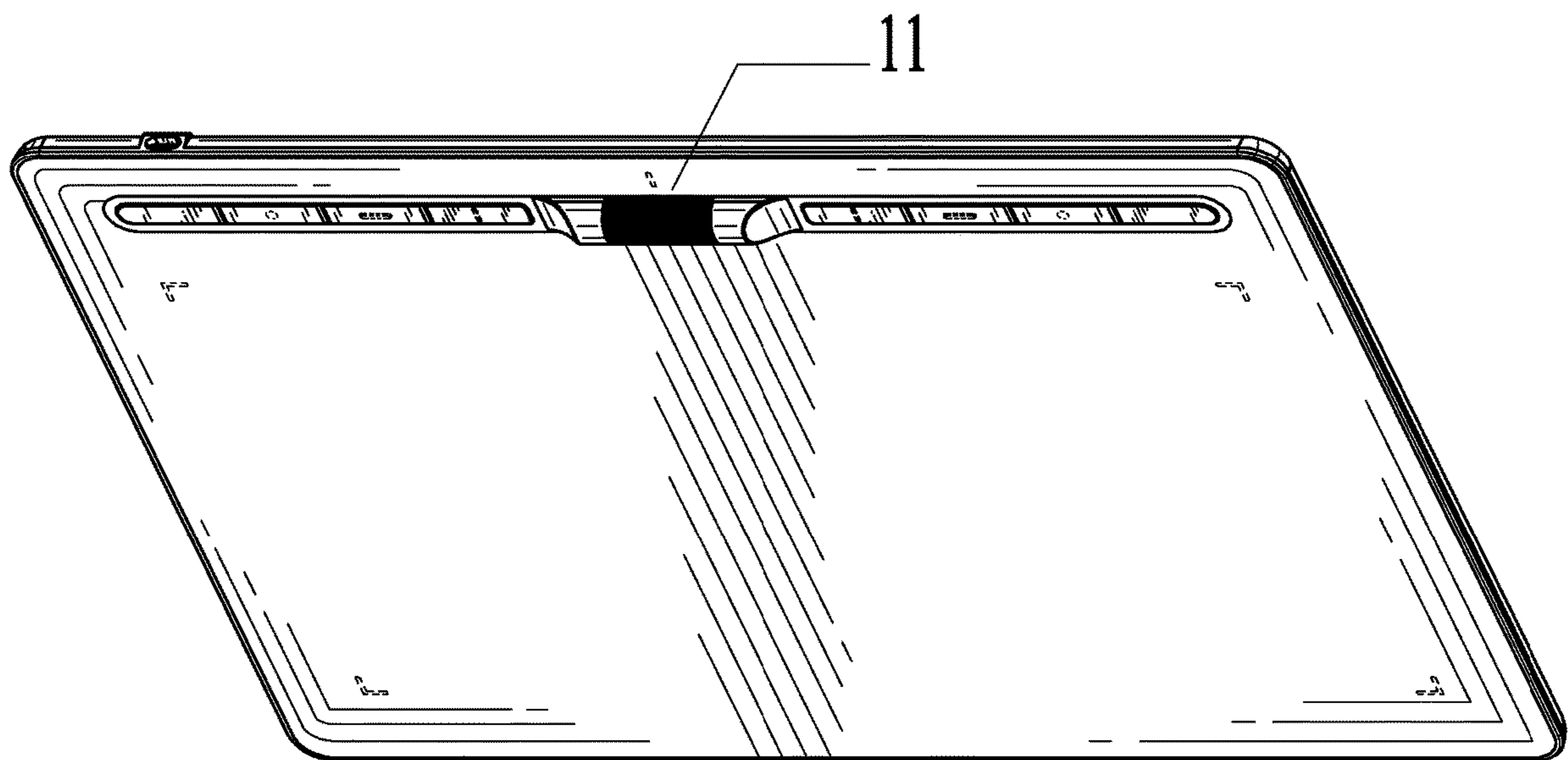

FIG. 7

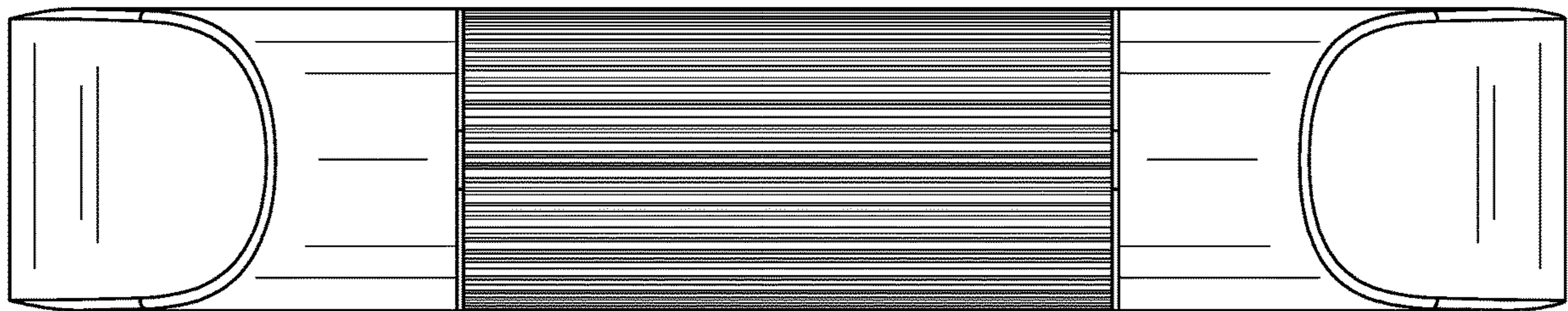

FIG. 8

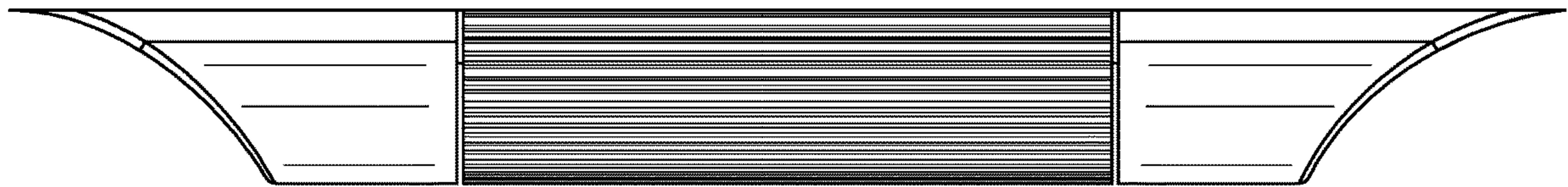

FIG. 9

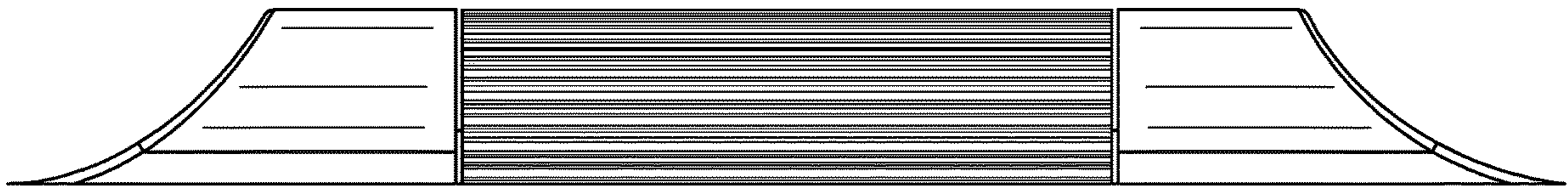

FIG. 10

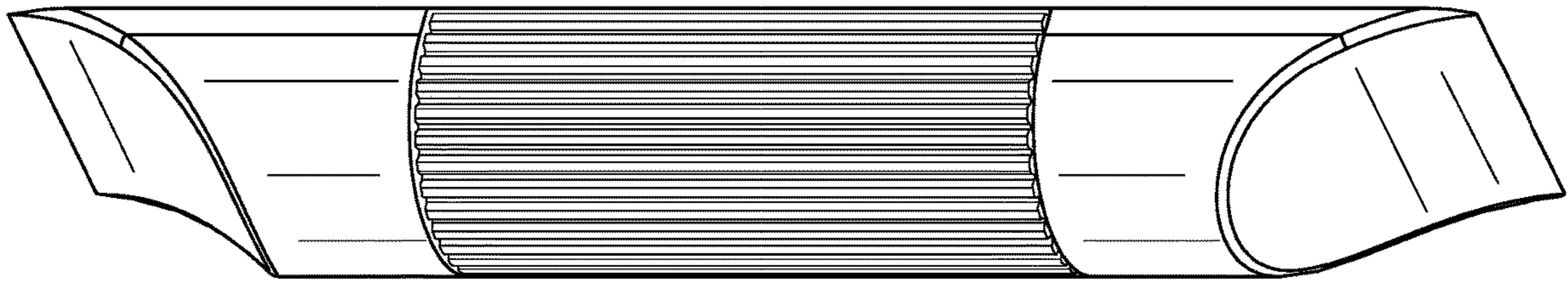

FIG. 11