



US00D899422S

(12) **United States Design Patent** (10) **Patent No.:** **US D899,422 S**  
**Wakefield** (45) **Date of Patent:** **\*\* Oct. 20, 2020**

(54) **ELECTRONIC DEVICE**

(71) Applicant: **Franz Antonio Wakefield**, Miami, FL (US)

(72) Inventor: **Franz Antonio Wakefield**, Miami, FL (US)

(\*\*) Term: **14 Years**

(21) Appl. No.: **29/439,095**

(22) Filed: **Dec. 6, 2012**

(51) **LOC (12) Cl.** ..... **14-02**

(52) **U.S. Cl.**  
USPC ..... **D14/341**

(58) **Field of Classification Search**  
USPC ..... D14/341-347, 137, 138 R, 138 AA, D14/138 C, 138 G, 496, 203.3, 203.4,  
(Continued)

(56) **References Cited**

U.S. PATENT DOCUMENTS

D378,518 S \* 3/1997 Sumner ..... D14/479  
D396,452 S \* 7/1998 Naruki ..... D14/424  
(Continued)

FOREIGN PATENT DOCUMENTS

IS 82488-0001 \* 1/2014  
TN L/2013/82488-0 00 \* 1/2013  
(Continued)

*Primary Examiner* — Dana K Weiland

(74) *Attorney, Agent, or Firm* — Franz A. Wakefield, Pro Se

(57) **CLAIM**

The ornamental design for an electronic device, as shown and described herein.

**DESCRIPTION**

FIG. 1 is a front view of an electronic device showing my new design in a first embodiment;

FIG. 2 is a rear view thereof;  
FIG. 3 is a bottom view thereof;  
FIG. 4 is a top view thereof;  
FIG. 5 is a left side view of the electronic device shown with a kickstand in a closed position;  
FIG. 6 is another left side view of the electronic device shown with the kickstand in an open position;  
FIG. 7 is a right side view of the electronic device shown with the kickstand in a closed position  
FIG. 8 is another right side view of the electronic device shown with the kickstand in an open position;  
FIG. 9 is a front view of the electronic device showing my new design in a second embodiment;  
FIG. 10 is a rear view thereof;  
FIG. 11 is a bottom view thereof;  
FIG. 12 is a top view thereof;  
FIG. 13 is a left side view of the electronic device shown with a kickstand in a closed position;  
FIG. 14 is another left side view of the electronic device shown with the kickstand in an open position;  
FIG. 15 is a right side view of the electronic device shown with the kickstand in a closed position;  
FIG. 16 is another right side view of the electronic device shown with the kickstand in an open position;  
FIG. 17 is a front view of the electronic device showing my new design in a third embodiment;  
FIG. 18 is a rear view thereof;  
FIG. 19 is a bottom view thereof;  
FIG. 20 is a top view thereof;  
FIG. 21 is a left side view of the electronic device shown with a kickstand in a closed position;  
FIG. 22 is another left side view of the electronic device shown with the kickstand in an open position;  
FIG. 23 is a right side view of the electronic device shown with the kickstand in a closed position; and,  
FIG. 24 is another right side view of the electronic device shown with the kickstand in an open position.  
The broken lines shown in the drawings depict portions of the electronic device that form no part of the claimed design. The innermost solid line geometric feature in FIGS. 1, 9, and 17 is coplanar with the protruding broken line geometric feature surrounding it.

**1 Claim, 12 Drawing Sheets**

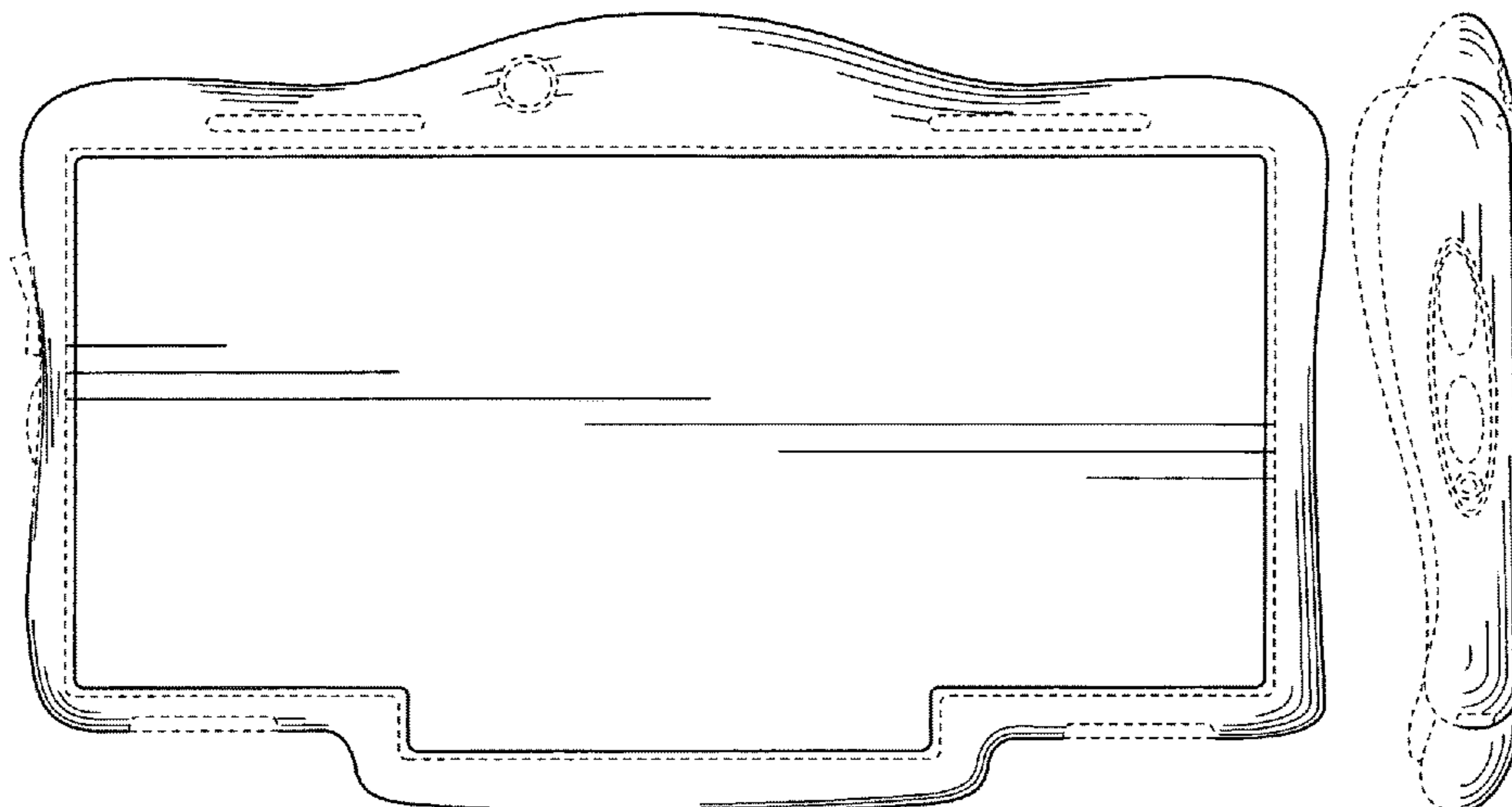

(58) **Field of Classification Search**

USPC ..... D14/203.7, 147, 218, 248, 426, 420,  
 D14/315-318, 240, 129-130, 138 AB,  
 D14/138 AC, 138 AD, 203.1-203.8, 247,  
 D14/371, 388-389, 374; D10/65, 104.1,  
 D10/50; D18/6-7; D21/324, 329, 330,  
 D21/332; 455/556.1, 556.2, 566, 575.1,  
 455/90.3; 379/433.04, 433.01, 433.06,  
 379/916; 345/173, 901, 905;  
 361/679.26, 679.3, 679.55, 679.56;  
 D6/308, 310; D19/26, 59, 60  
 CPC ..... G06F 3/044; G06F 1/1613; G06F 1/1626;  
 G06F 2200/1633; G06F 3/0488; G06F  
 3/04886; G06F 3/0412; G06F 3/0416;  
 H04B 1/3833

See application file for complete search history.

(56) **References Cited**

U.S. PATENT DOCUMENTS

D405,480 S \* 2/1999 Yamazaki ..... D21/475  
 D419,599 S \* 1/2000 Mak ..... D21/469  
 D432,137 S \* 10/2000 Holtzman ..... D14/458  
 D435,066 S \* 12/2000 Hurschman ..... D19/113  
 D451,507 S \* 12/2001 Lin ..... D14/345  
 D462,679 S \* 9/2002 Liu ..... D14/341  
 D464,345 S \* 10/2002 Liu ..... D14/341  
 D467,971 S \* 12/2002 Mak ..... D21/469  
 D484,133 S \* 12/2003 Liu ..... D14/375  
 D492,303 S \* 6/2004 Schlieffers ..... D14/341  
 D493,787 S \* 8/2004 Avery ..... D14/345  
 7,106,578 B2 \* 9/2006 Chen ..... 361/679.21  
 D537,883 S \* 3/2007 Gunter ..... D20/10  
 D539,354 S \* 3/2007 Mak ..... D21/329  
 D541,769 S \* 5/2007 Hoehn et al. .... D14/126  
 D562,319 S \* 2/2008 Kwon ..... D14/375  
 D591,801 S \* 5/2009 Mak ..... D21/469

D601,557 S \* 10/2009 Wesolek ..... D14/341  
 D606,763 S \* 12/2009 Chiu ..... D14/371  
 D623,186 S \* 9/2010 Ludlum ..... D14/371  
 D628,570 S \* 12/2010 Li ..... D14/341  
 D632,094 S \* 2/2011 Shaha ..... D6/310  
 D658,172 S \* 4/2012 Lee et al. .... D14/342  
 D660,295 S \* 5/2012 Mak ..... D14/345  
 D674,386 S \* 1/2013 Mak ..... D14/341  
 D698,354 S \* 1/2014 Mak ..... D14/341  
 D703,663 S \* 4/2014 Piraud ..... D14/341  
 D703,664 S \* 4/2014 Spiro ..... D14/341  
 D716,291 S \* 10/2014 Burris ..... D14/341  
 D723,548 S \* 3/2015 Cheung ..... D14/341  
 D723,549 S \* 3/2015 Kwong ..... D14/341  
 D723,551 S \* 3/2015 Fu ..... D14/341  
 D723,802 S \* 3/2015 Jones ..... D3/274  
 D724,581 S \* 3/2015 Johnson ..... D14/341  
 D735,189 S \* 7/2015 Ji ..... D14/341  
 D744,997 S \* 12/2015 Fujioka ..... D14/341  
 D748,674 S \* 2/2016 Cheung ..... D14/341  
 D786,860 S \* 5/2017 Cheung ..... D14/341  
 D829,720 S \* 10/2018 Zhang ..... D14/440  
 D831,024 S \* 10/2018 Wakefield ..... D14/341  
 D862,479 S \* 10/2019 Ahn ..... D14/440  
 D875,831 S \* 2/2020 Jiang ..... D19/113  
 D879,789 S \* 3/2020 Li ..... D14/440  
 D884,702 S \* 5/2020 Huang ..... D14/420  
 D884,709 S \* 5/2020 Cheng ..... D14/440  
 D886,109 S \* 6/2020 Li ..... D14/440  
 2007/0054736 A1 \* 3/2007 See ..... A63F 13/06  
 463/37  
 2012/0162098 A1 \* 6/2012 Aboud et al. .... 345/173  
 2014/0317559 A1 \* 10/2014 Wakefield ..... G06F 3/0481  
 715/788

FOREIGN PATENT DOCUMENTS

TR 655305-0001 \* 5/2013  
 WO D082488-001 \* 1/2014

\* cited by examiner

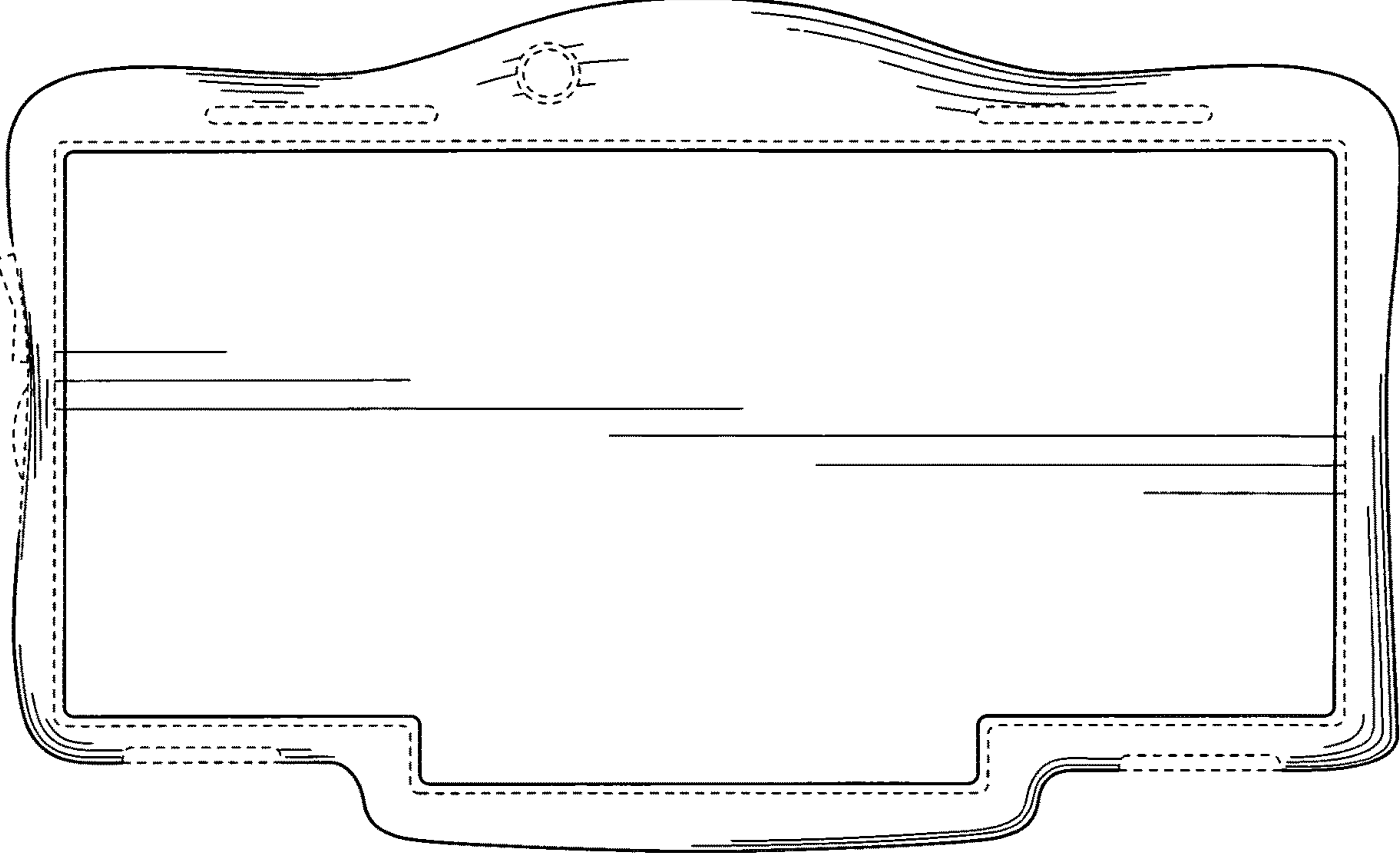

FIG. 1

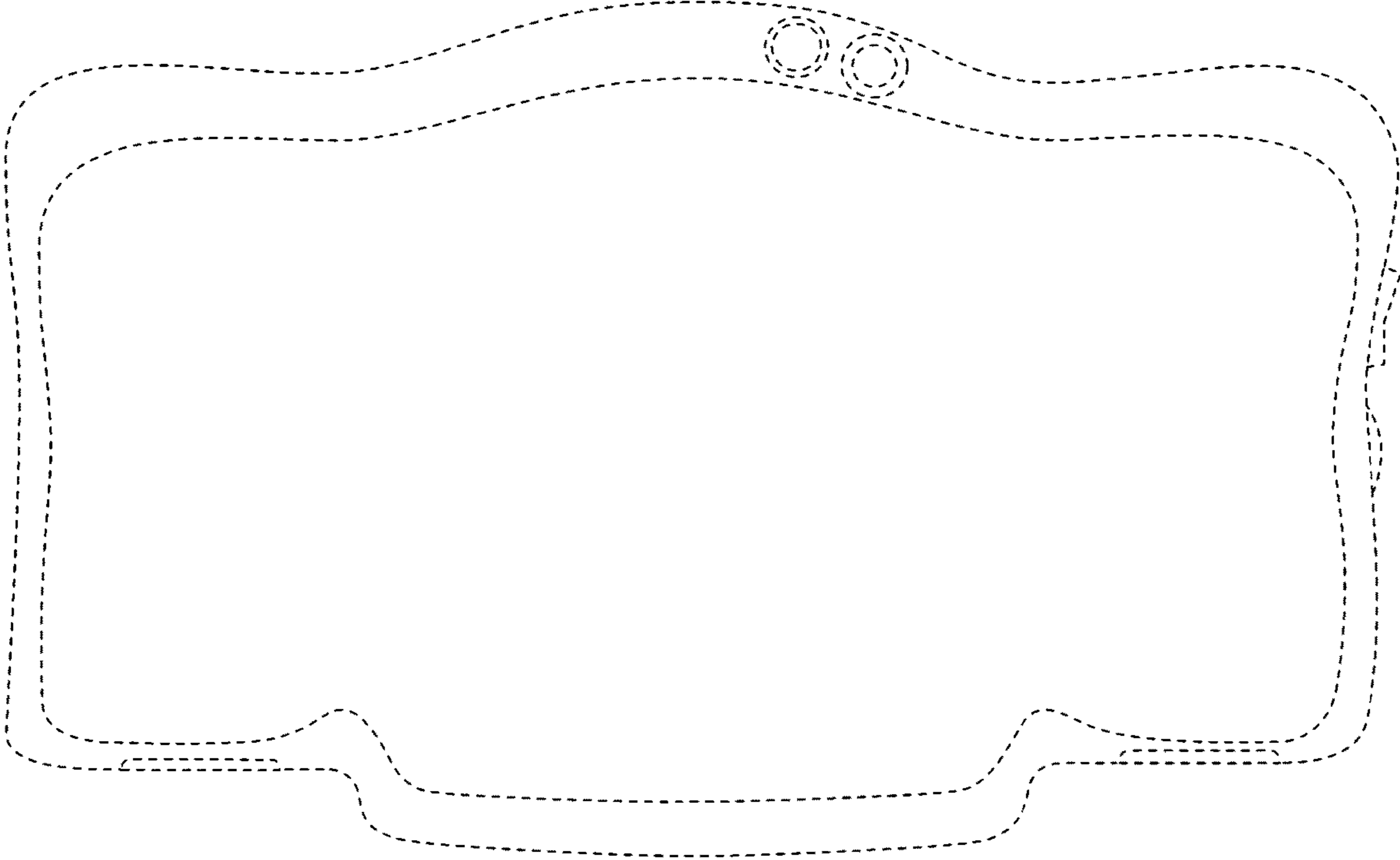

FIG. 2





FIG. 3

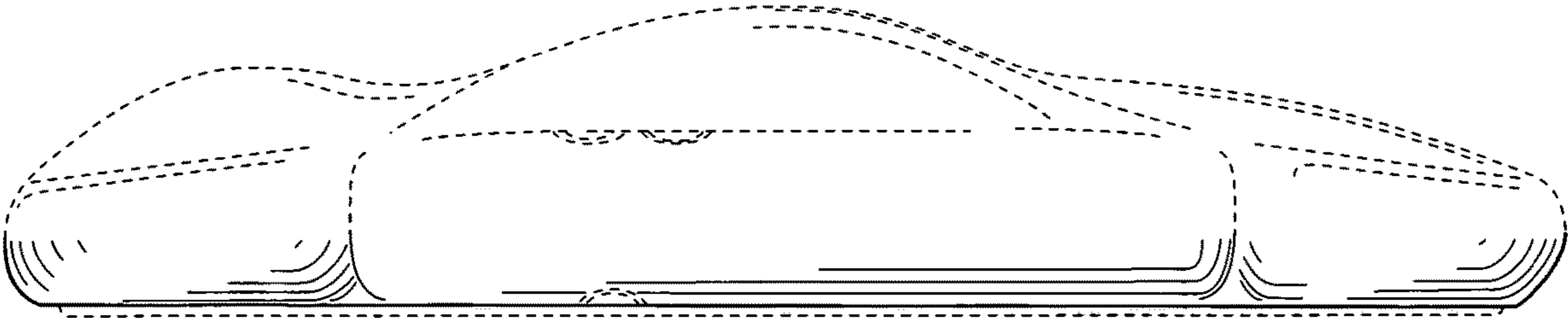

FIG. 4

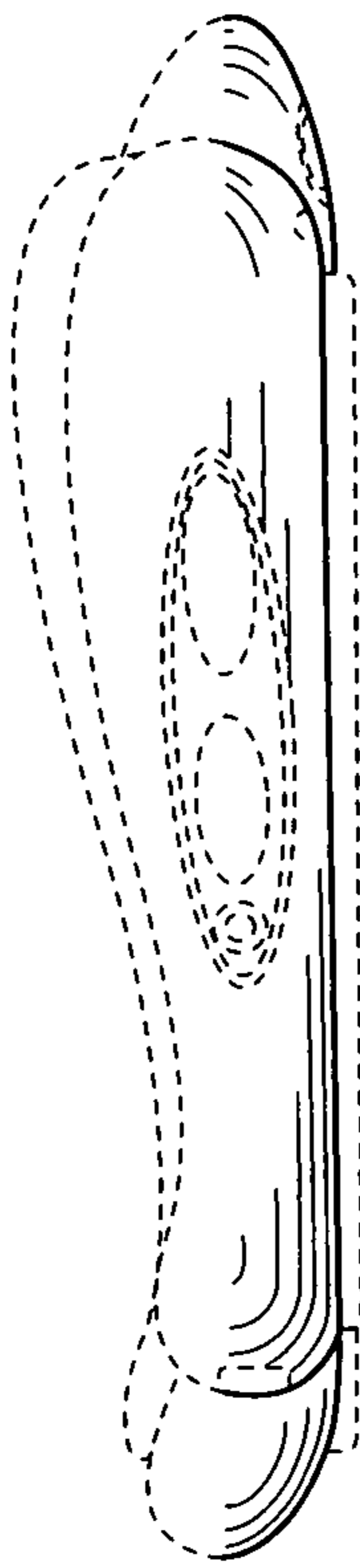

FIG. 5

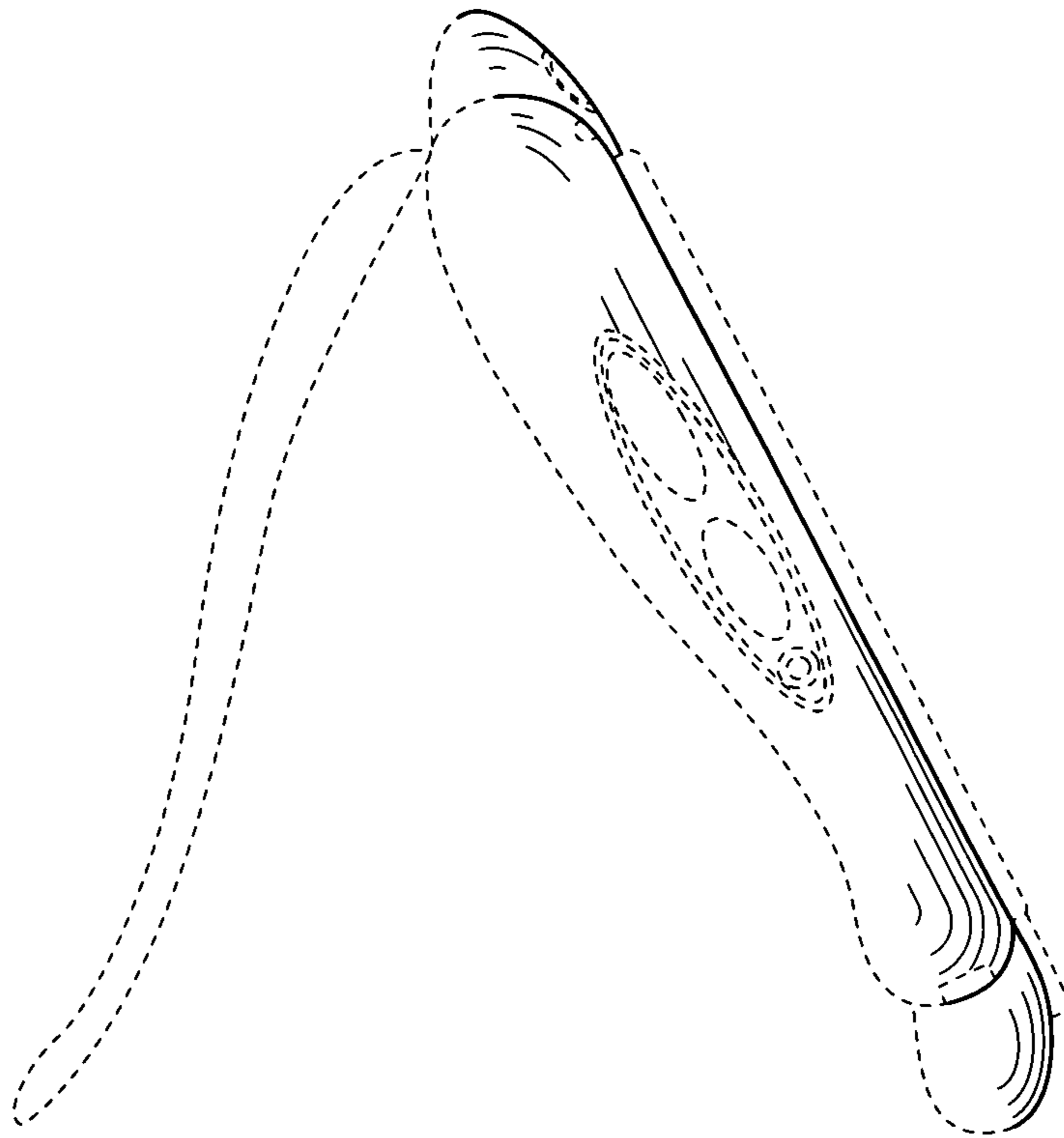

FIG. 6

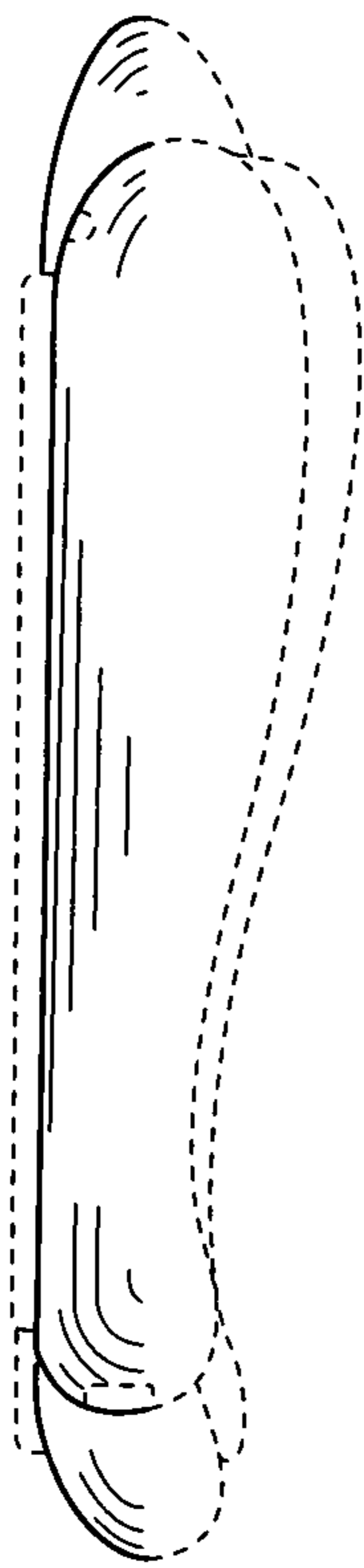

FIG. 7

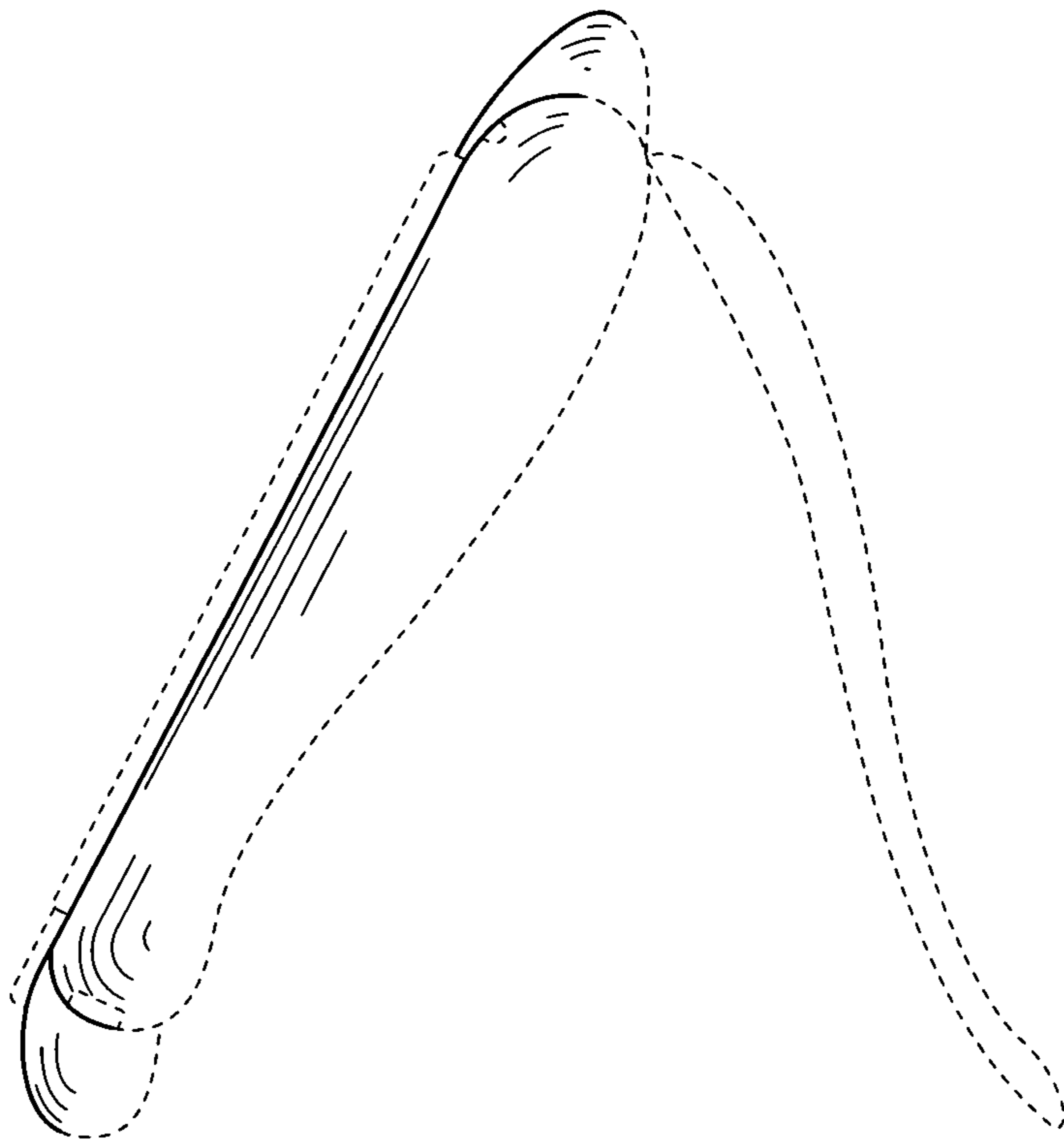

FIG. 8

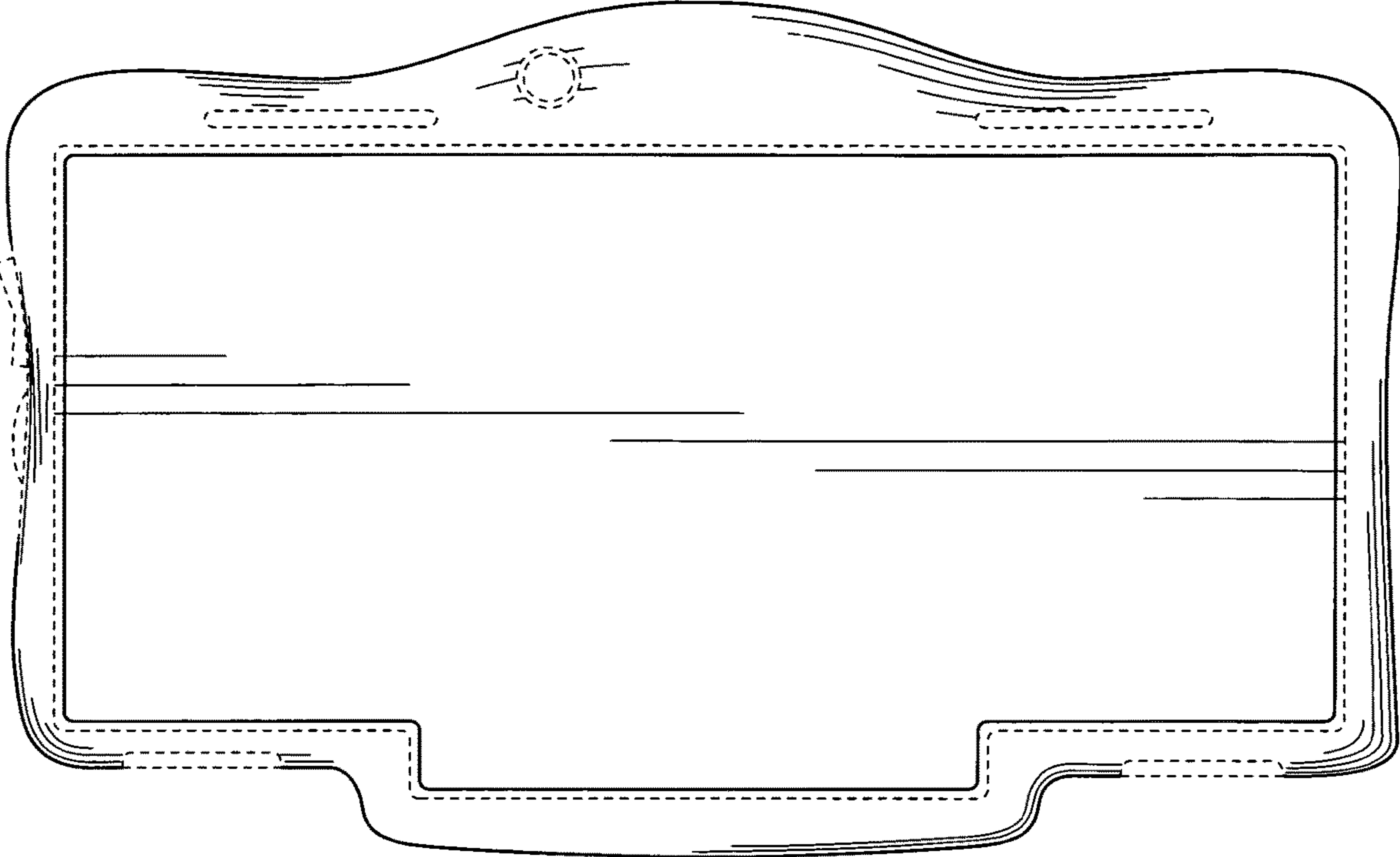

FIG. 9

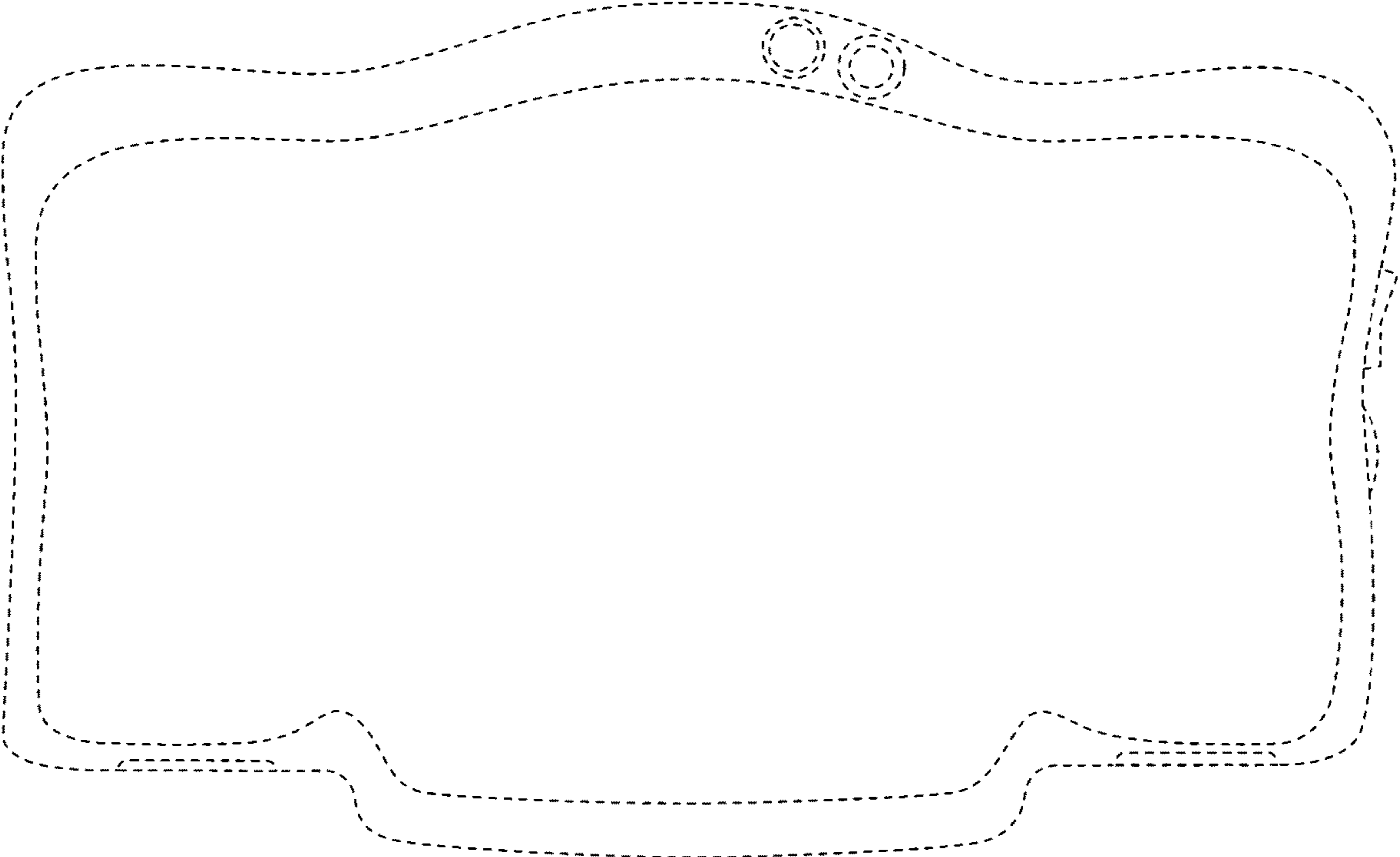

FIG. 10

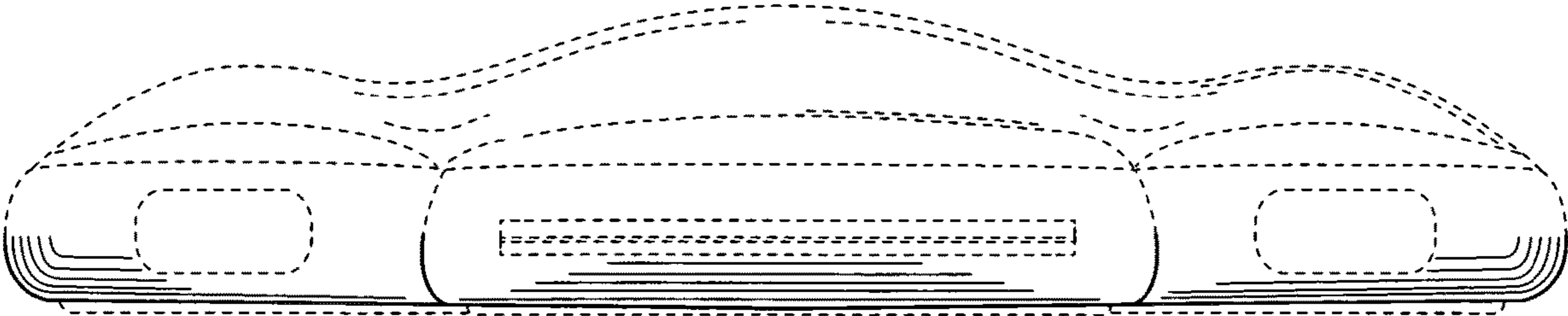

FIG. 11



FIG. 12



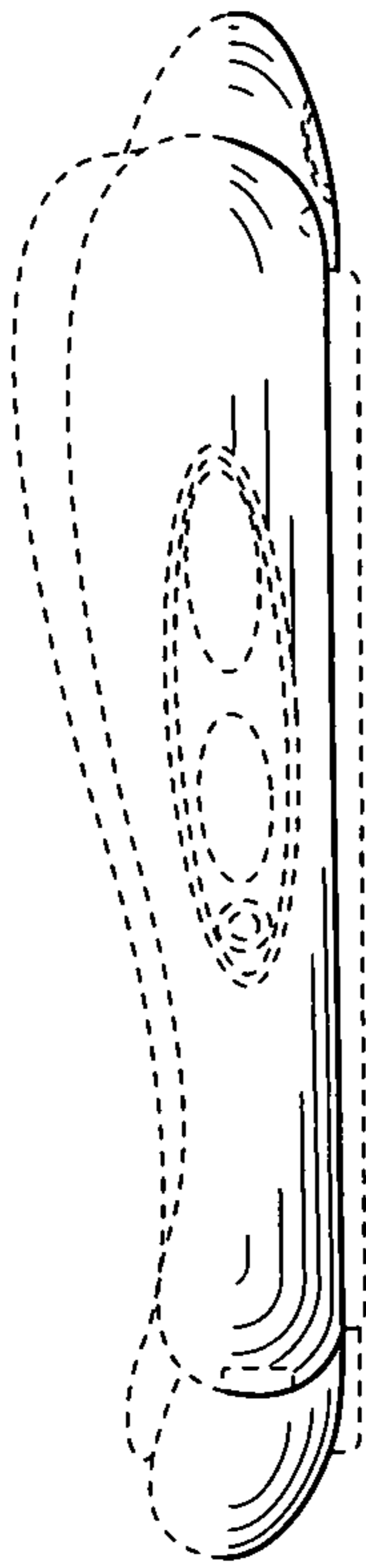

FIG. 13

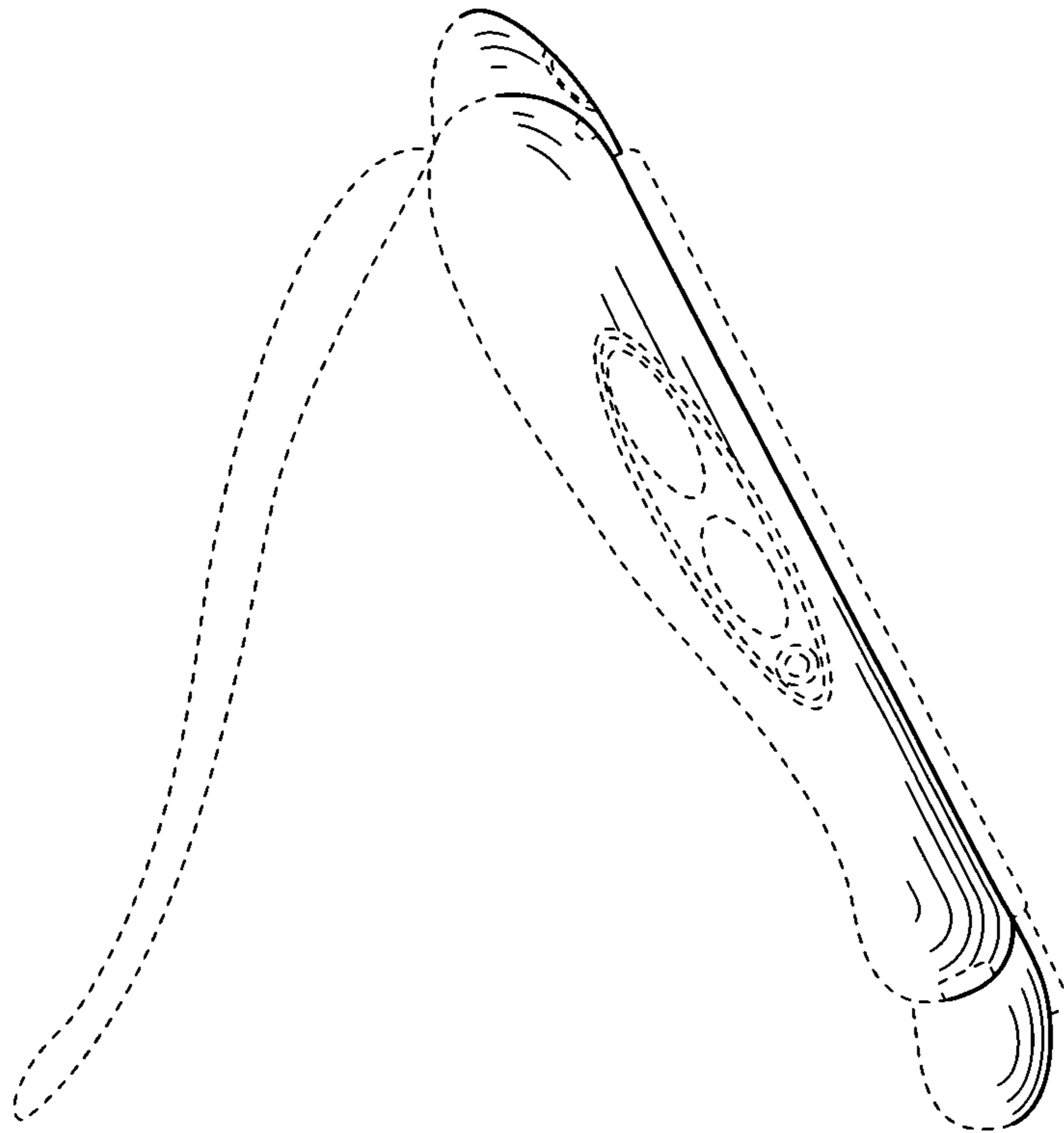
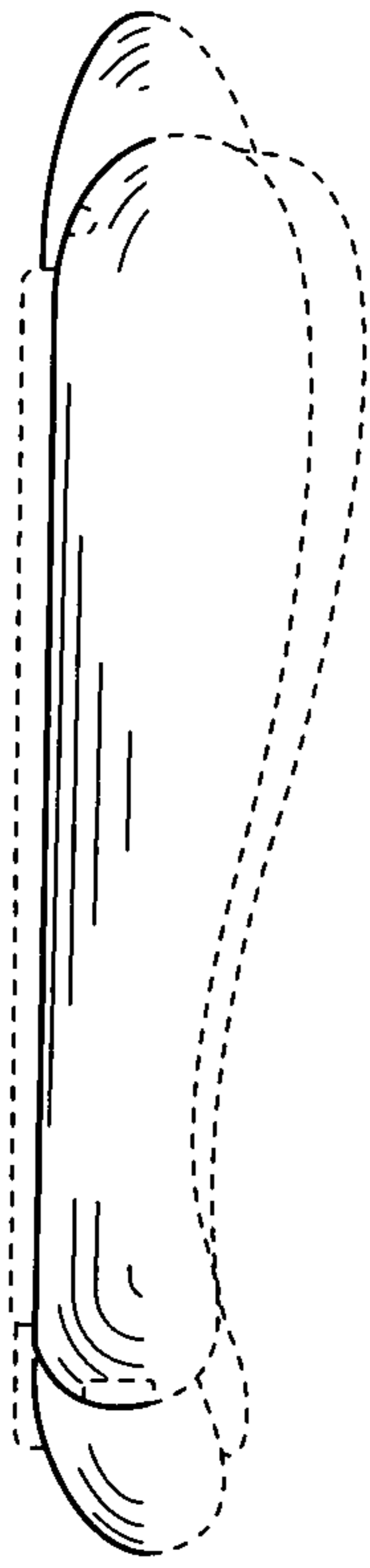
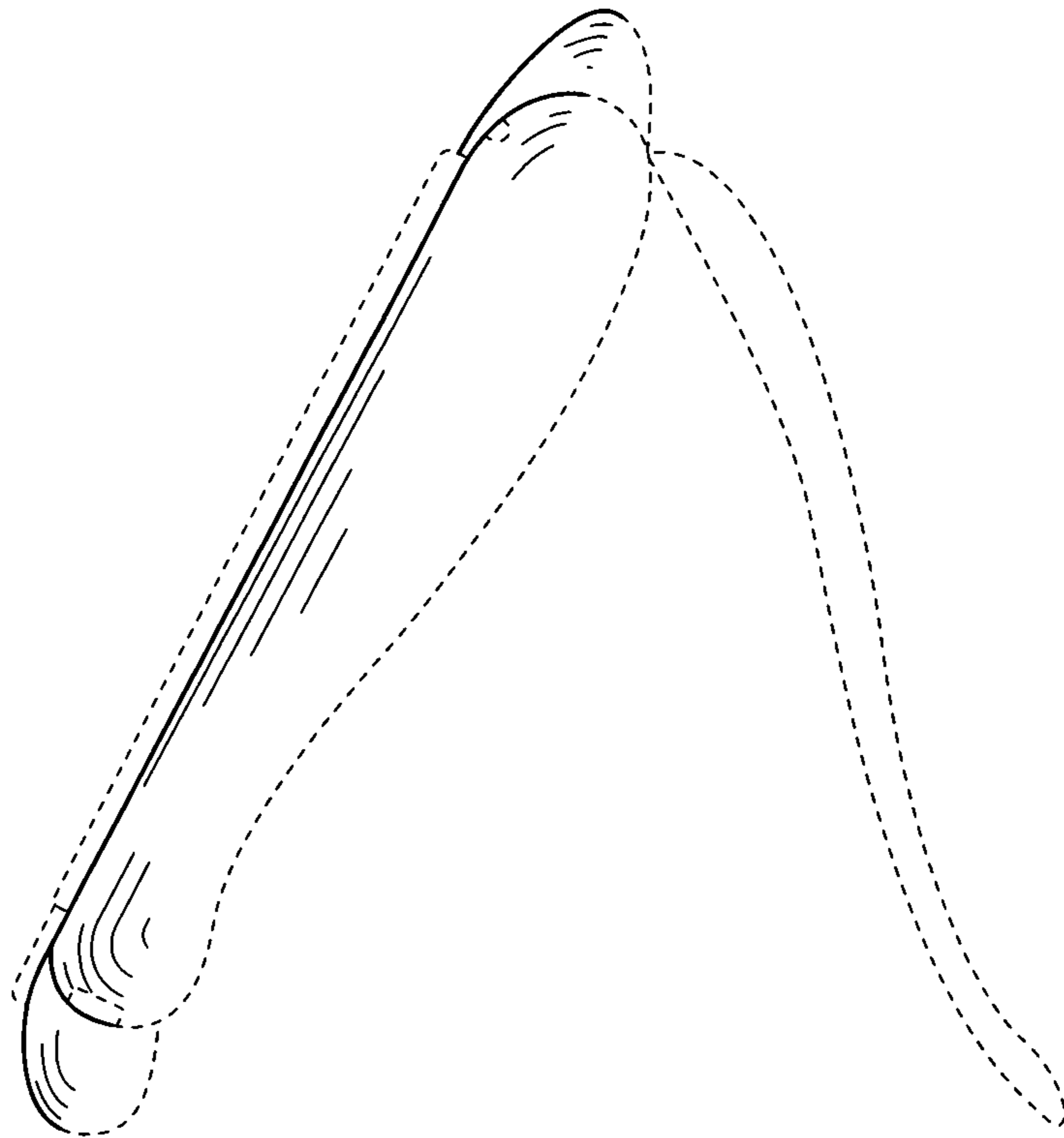

FIG. 14



**FIG. 15**



**FIG. 16**

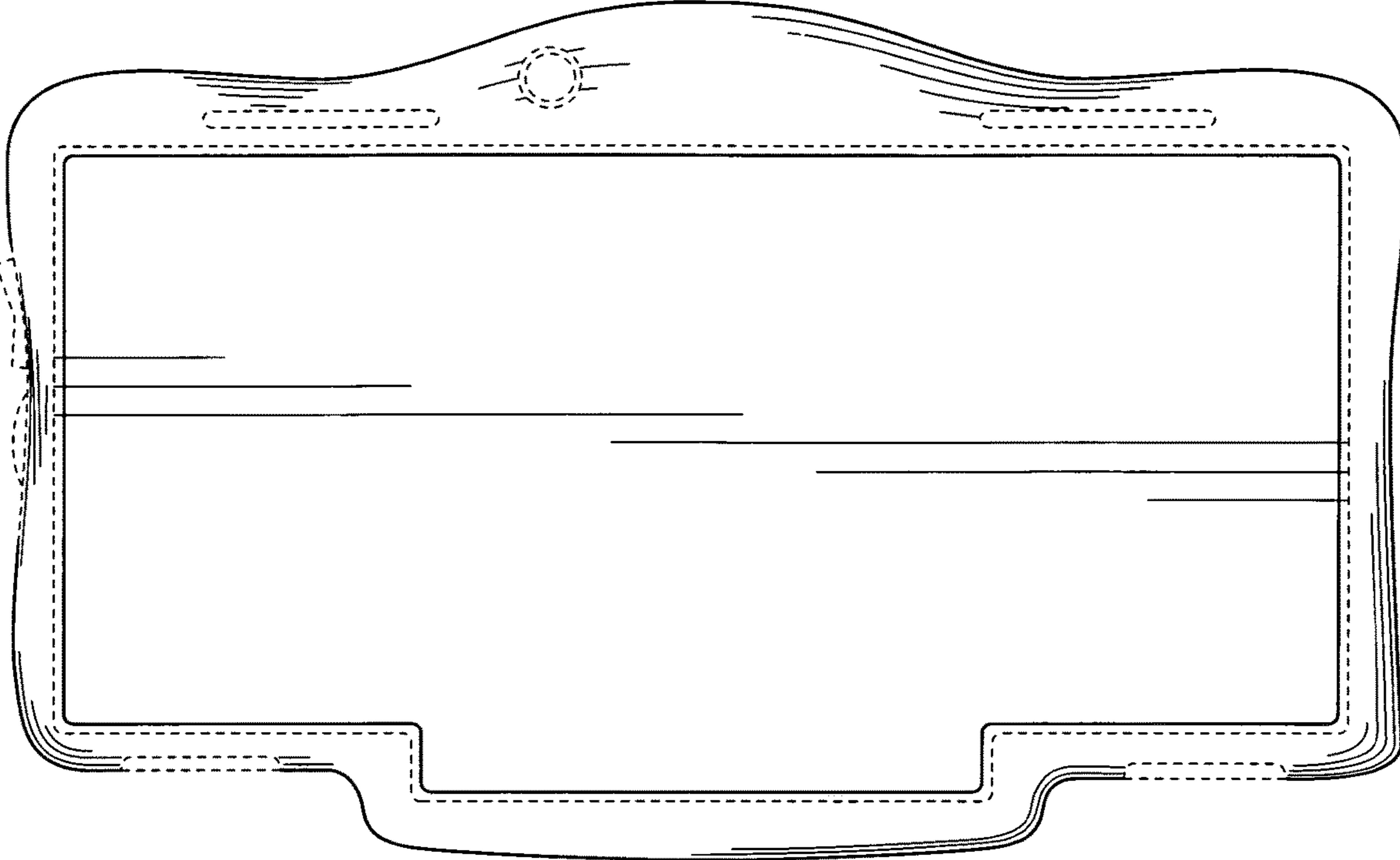

FIG. 17

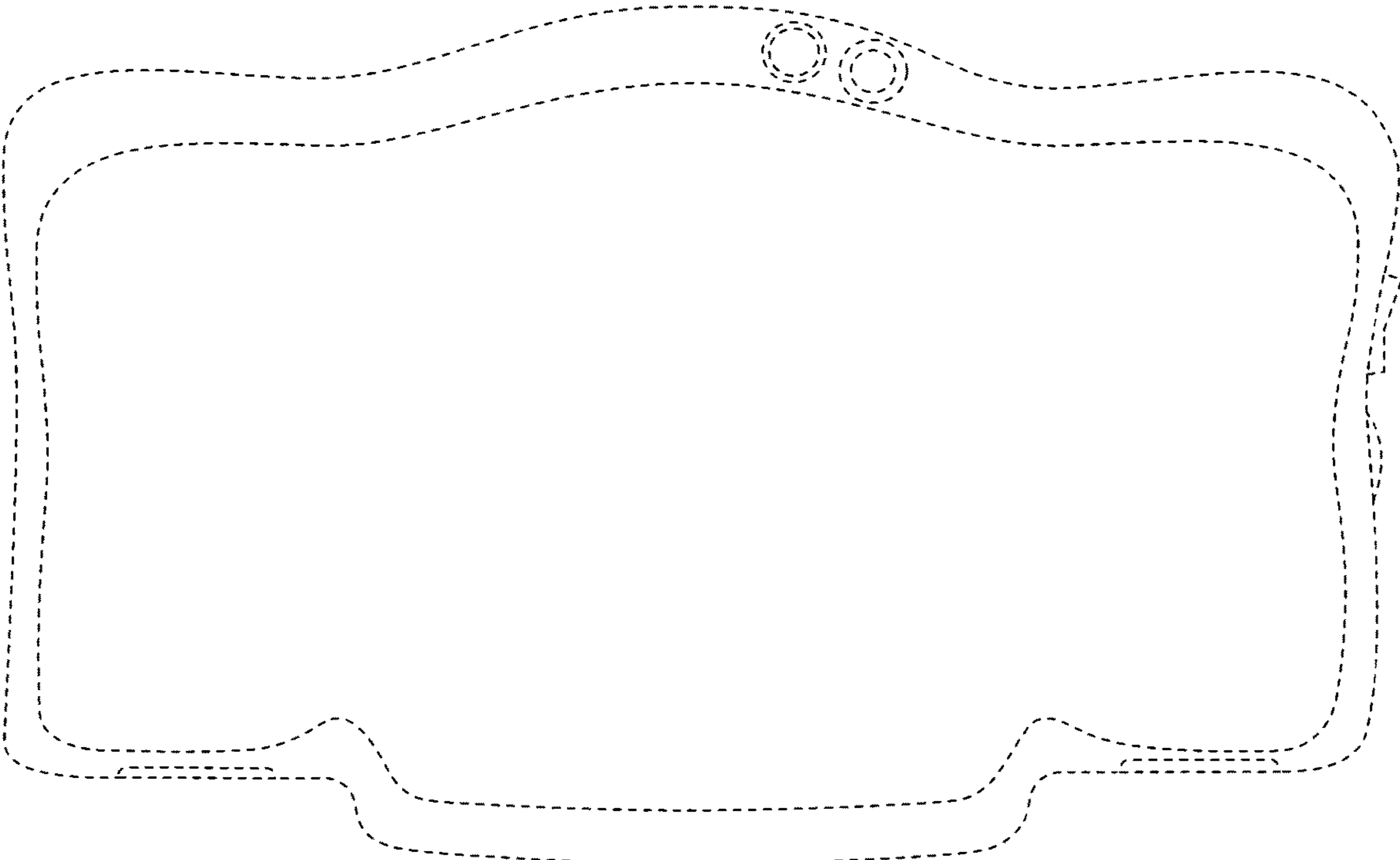

FIG. 18

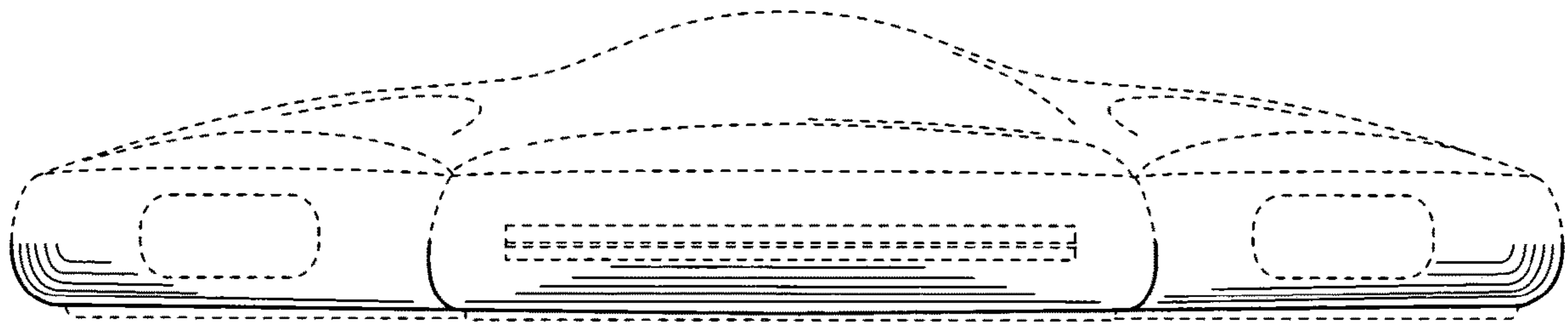

FIG. 19

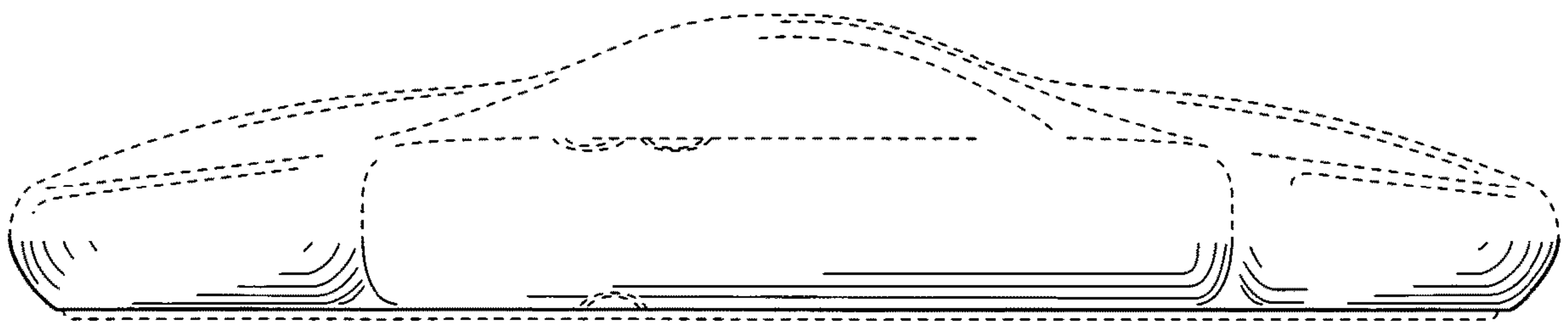
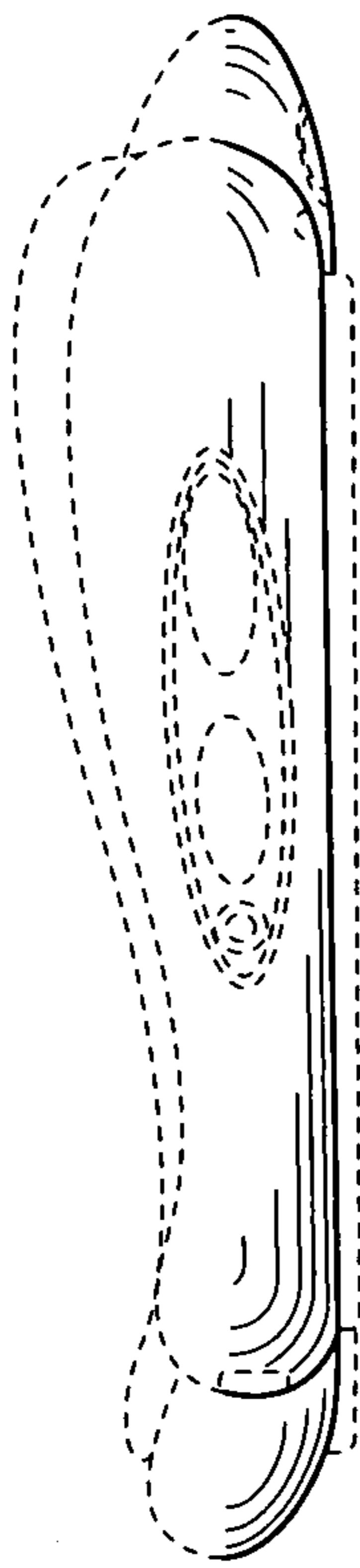
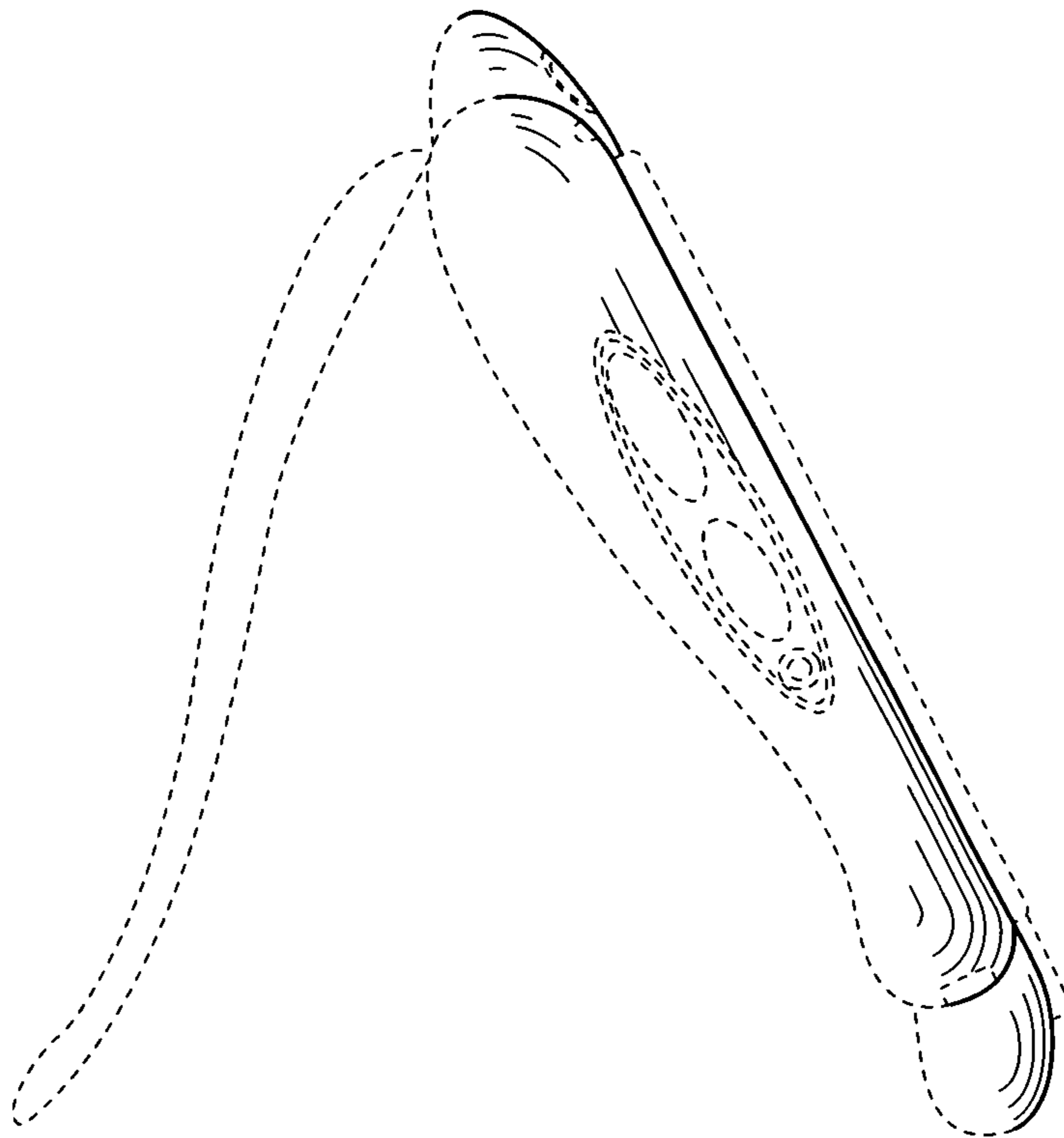

FIG. 20

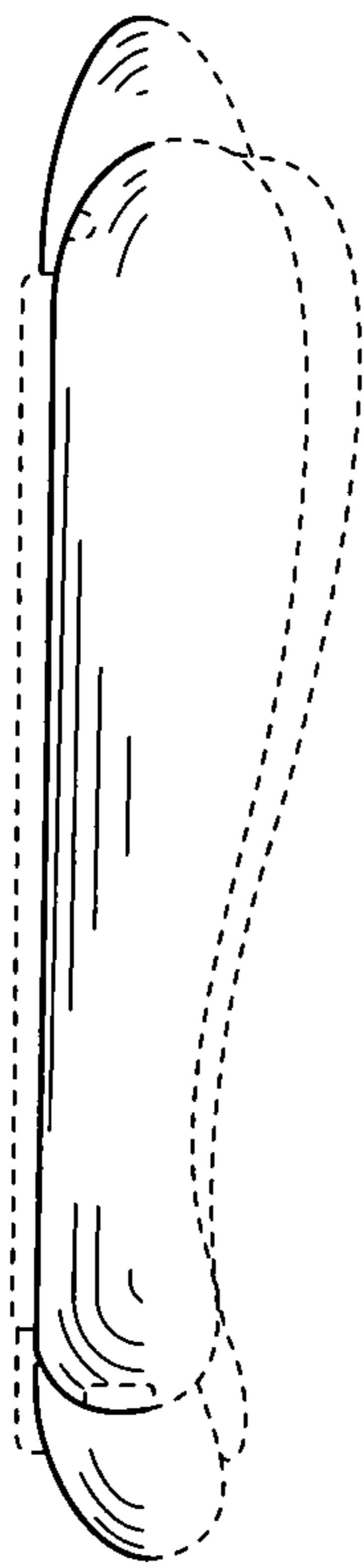

**FIG. 21**

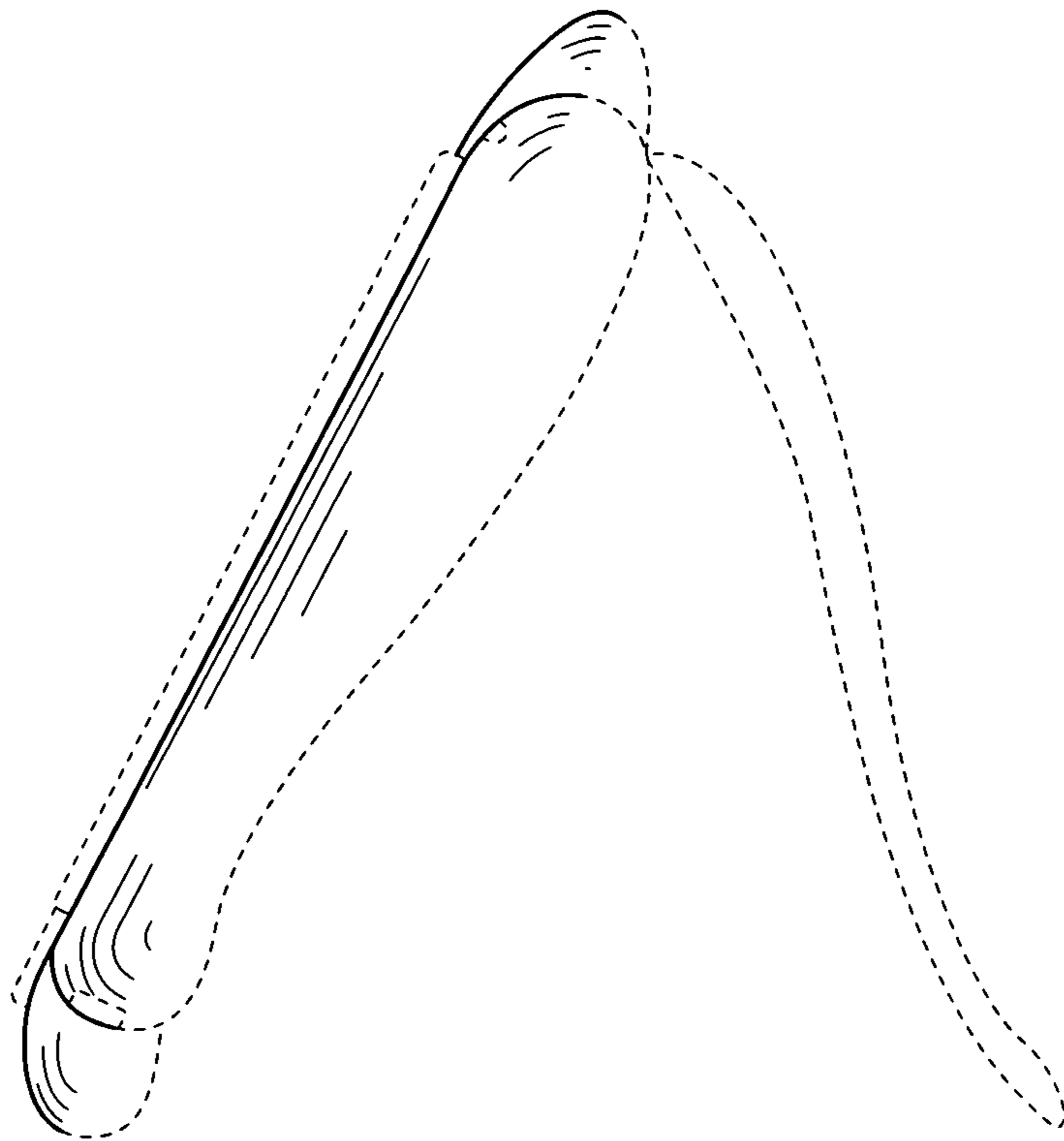

**FIG. 22**





**FIG. 23**



**FIG. 24**