



US00D899306S

(12) **United States Design Patent** (10) **Patent No.:** **US D899,306 S**
Kirzinger et al. (45) **Date of Patent:** **** Oct. 20, 2020**

(54) **MOTOR VEHICLE**
(71) Applicant: **VOLKSWAGEN AKTIENGESELLSCHAFT,**
Wolfsburg (DE)
(72) Inventors: **Albert-Johann Kirzinger,** Wolfsburg (DE); **Roland Faller,** Wolfsburg (DE); **Xavier Lescourret,** Wolfsburg (DE)

D776,006 S * 1/2017 Uchiyama D12/91
D812,523 S * 3/2018 Koizumi D12/91
D814,974 S * 4/2018 Koizumi D12/91
D818,875 S * 5/2018 Bischoff D12/90
D832,146 S * 10/2018 Metros D12/91
D835,001 S * 12/2018 Metros D12/91
D835,002 S * 12/2018 Metros D12/91
D850,979 S * 6/2019 Metros D12/91
D881,753 S * 4/2020 Tomasson D12/91
D883,858 S * 5/2020 Bischoff D12/99

(73) Assignee: **VOLKSWAGEN AKTIENGESELLSCHAFT,**
Wolfsburg (DE)

FOREIGN PATENT DOCUMENTS

DE 402014100895.7 10/2014

* cited by examiner

(**) Term: **15 Years**

Primary Examiner — Melody N Brown

(21) Appl. No.: **29/699,940**

(74) *Attorney, Agent, or Firm* — Lucas & Mercanti, LLP; Klaus P. Stoffel

(22) Filed: **Jul. 30, 2019**

(30) **Foreign Application Priority Data**

(57) **CLAIM**

Feb. 13, 2019 (DE) 40 2019 100 182

The ornamental design for a motor vehicle, as shown and described.

(51) **LOC (12) Cl.** **12-08**

DESCRIPTION

(52) **U.S. Cl.**
USPC **D12/91**

(58) **Field of Classification Search**
USPC D12/86, 90–92, 88, 164, 99; D21/424, D21/433, 434; 296/181.1–181.5, 183.1
CPC B62D 25/00; B62D 25/06; B62D 33/00; B62D 35/00
See application file for complete search history.

FIG. 1 is a front and right side perspective view of a motor vehicle showing our new design;
FIG. 2 is a rear and right side perspective view thereof;
FIG. 3 is a front and left side perspective view thereof;
FIG. 4 is a rear and left side perspective view thereof;
FIG. 5 is a front view thereof;
FIG. 6 is a rear view thereof;
FIG. 7 is a right side view thereof;
FIG. 8 is a left side view thereof; and,
FIG. 9 is a top view thereof.

(56) **References Cited**

U.S. PATENT DOCUMENTS

D450,629 S * 11/2001 Pfeiffer D12/90
D633,824 S * 3/2011 Fukui D12/91
D666,944 S * 9/2012 Morikawa D12/91
D670,199 S * 11/2012 Zhang D12/91
D732,429 S * 6/2015 Loeb D12/91

The wheels, headlights and taillights of the motor vehicle shown throughout the drawings views in a de-emphasized and faded out half tone manner are for environmental and illustrative purposes and form no part of the claimed design.

1 Claim, 5 Drawing Sheets

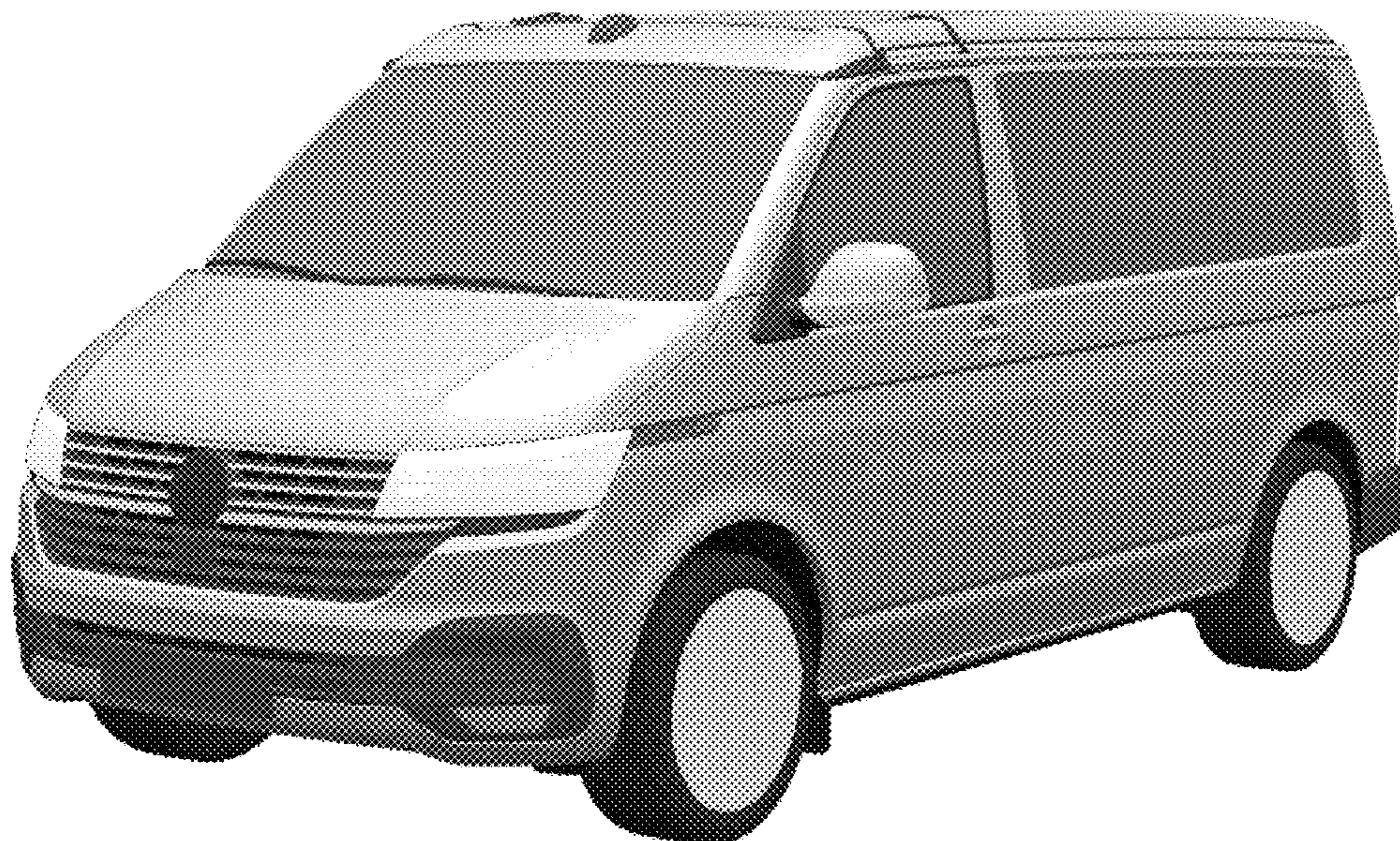

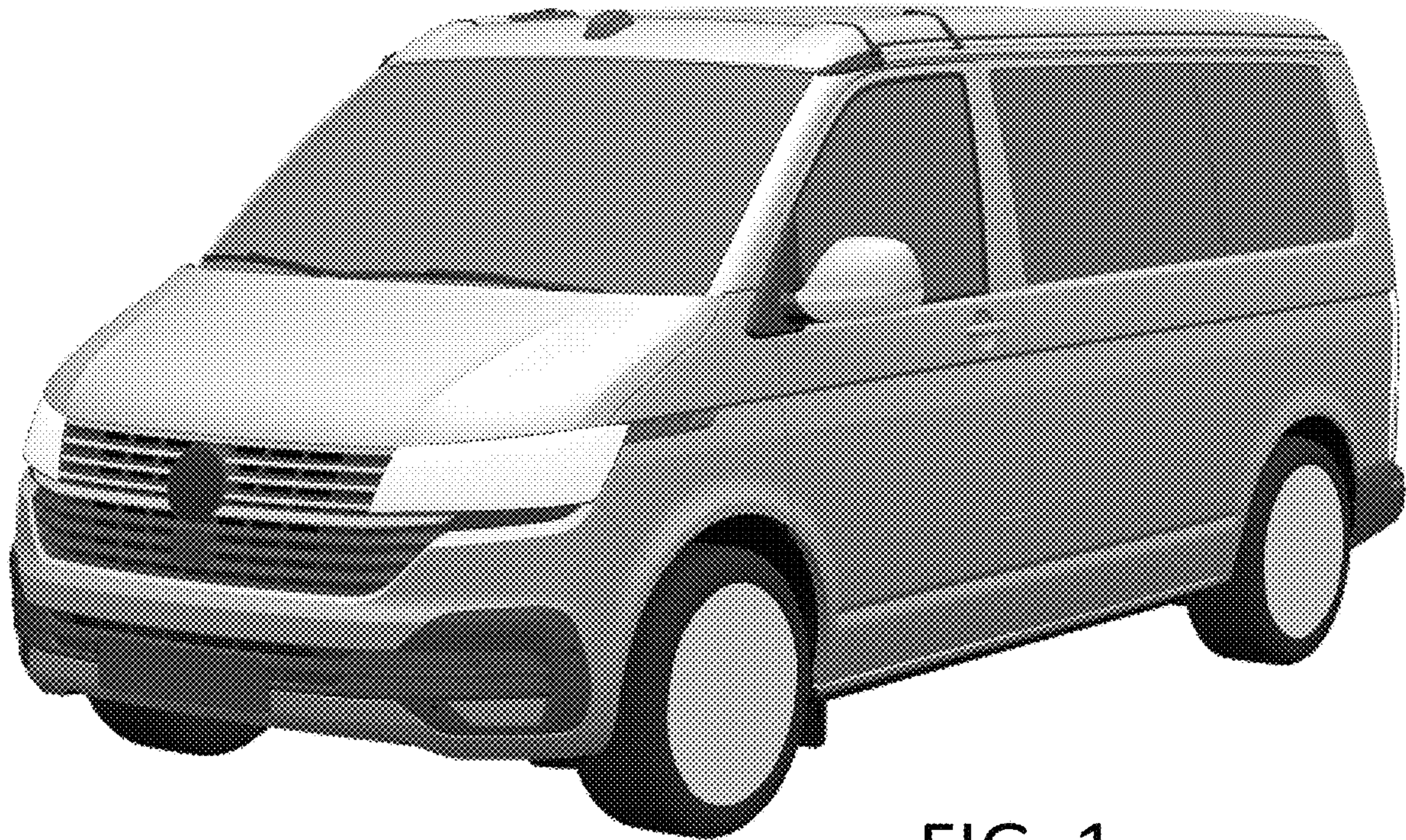

FIG. 1

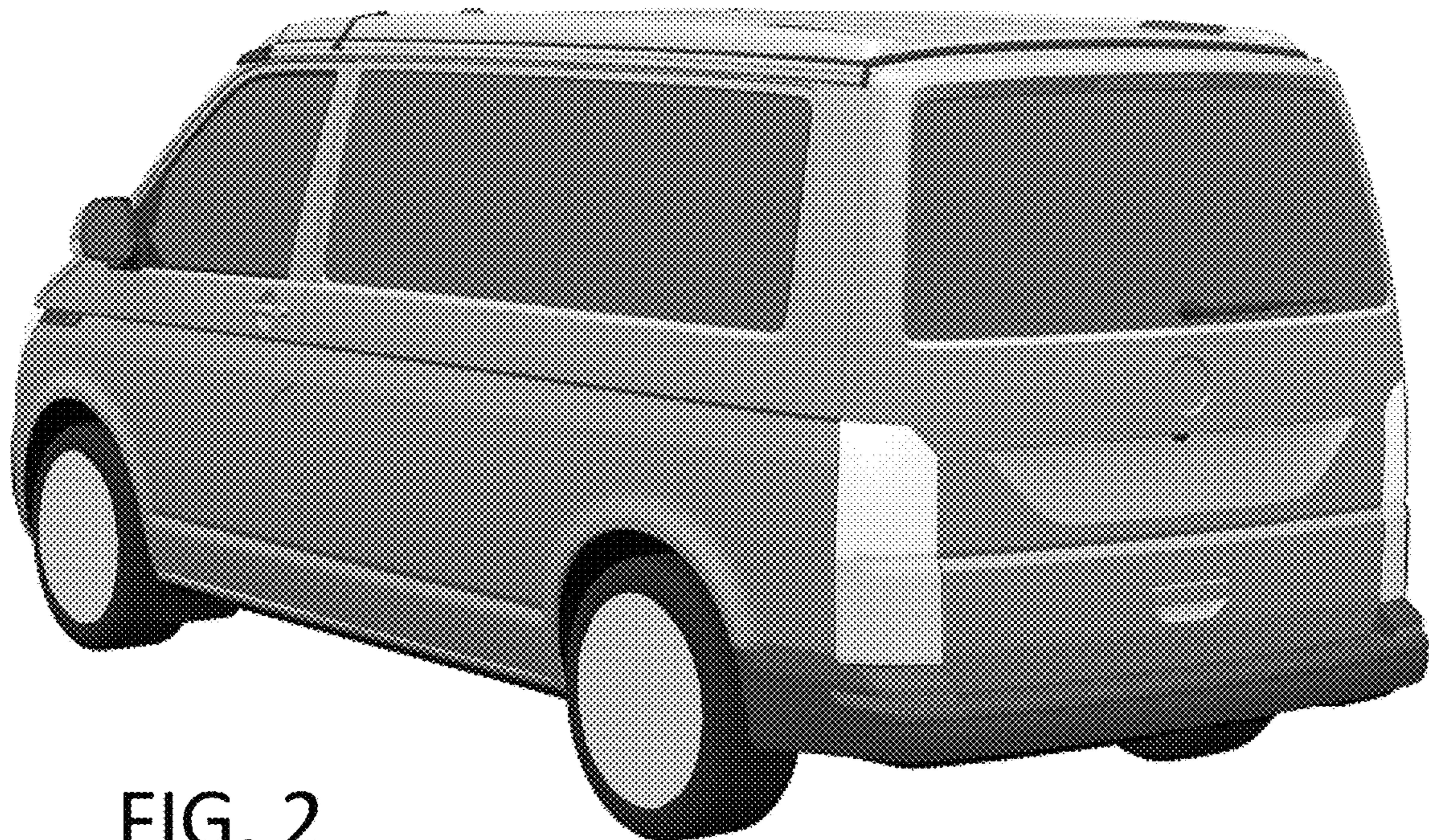

FIG. 2

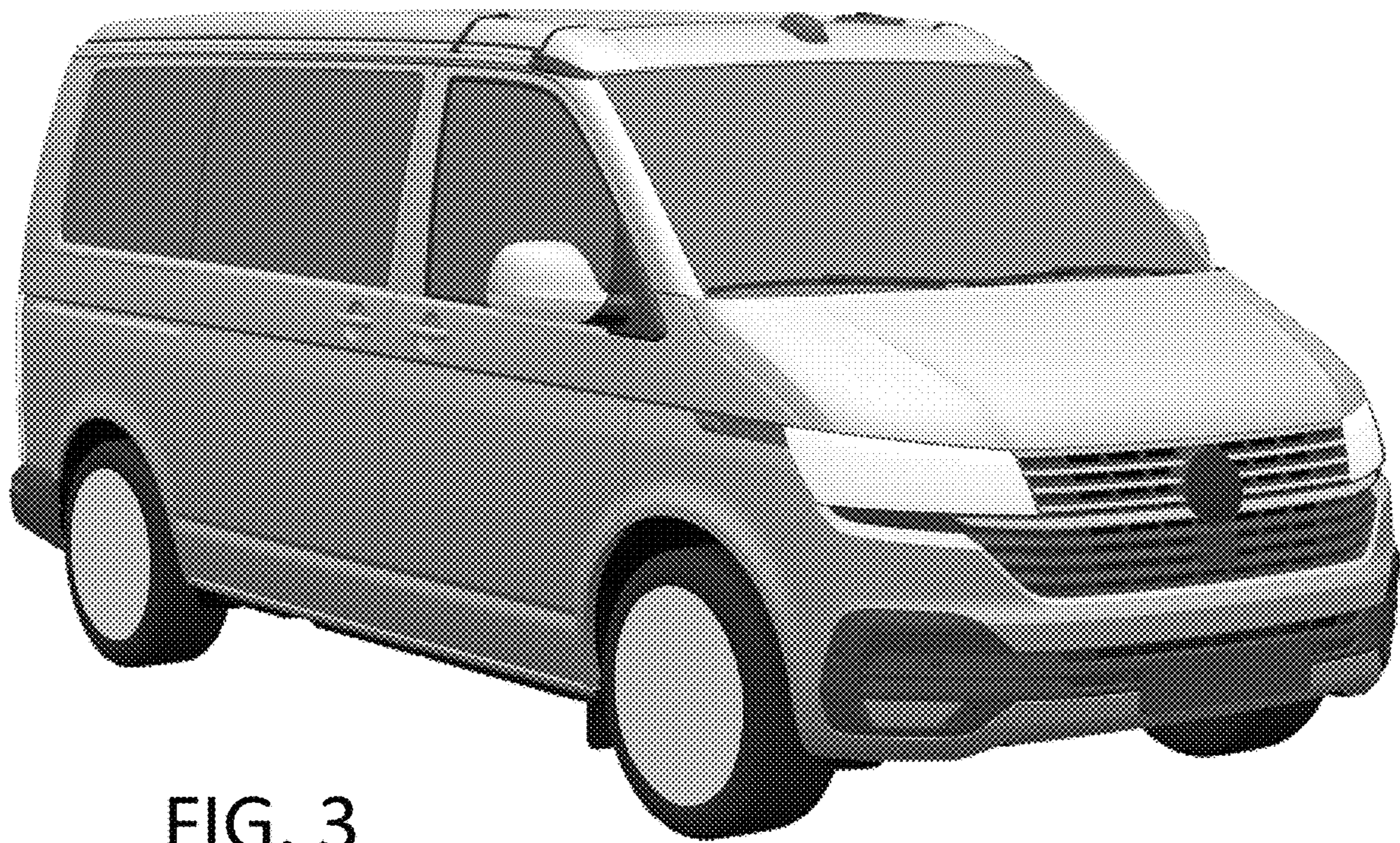

FIG. 3

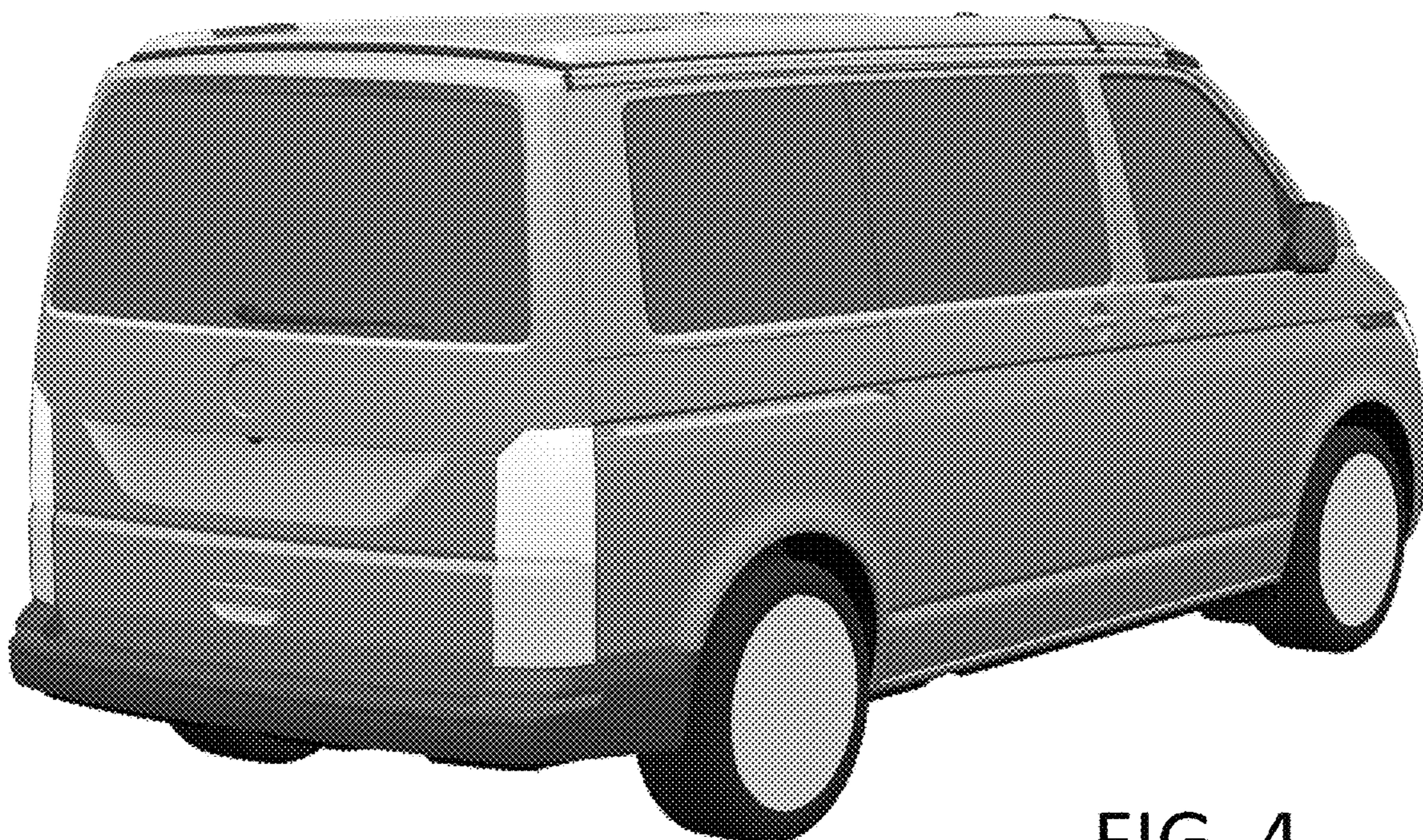

FIG. 4

FIG. 5



FIG. 6



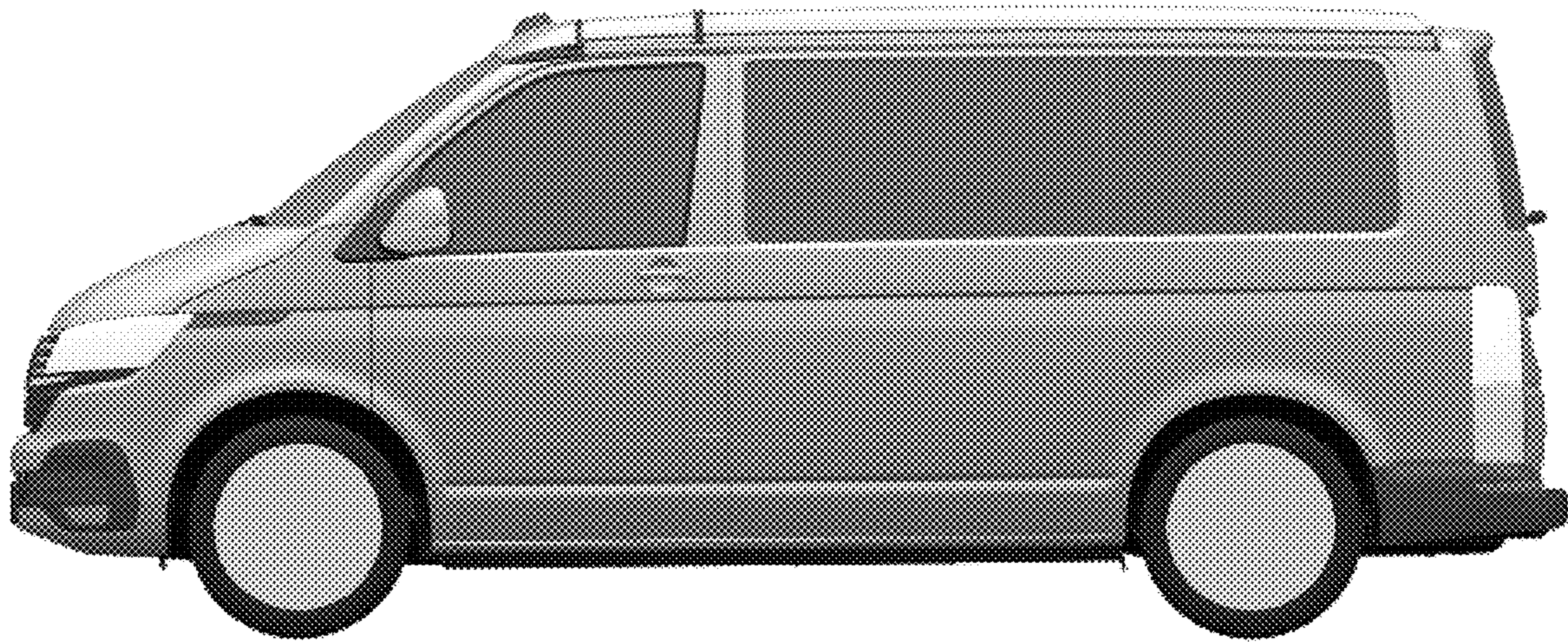

FIG. 7

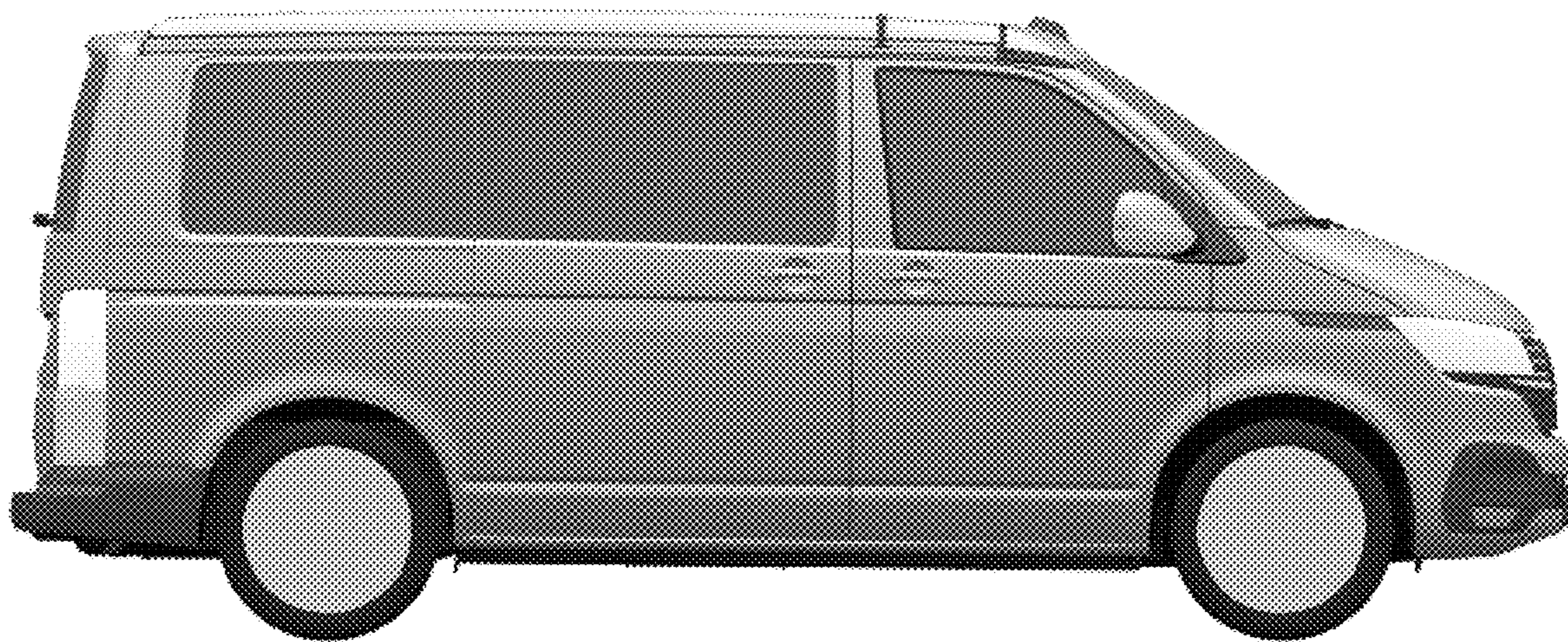

FIG. 8

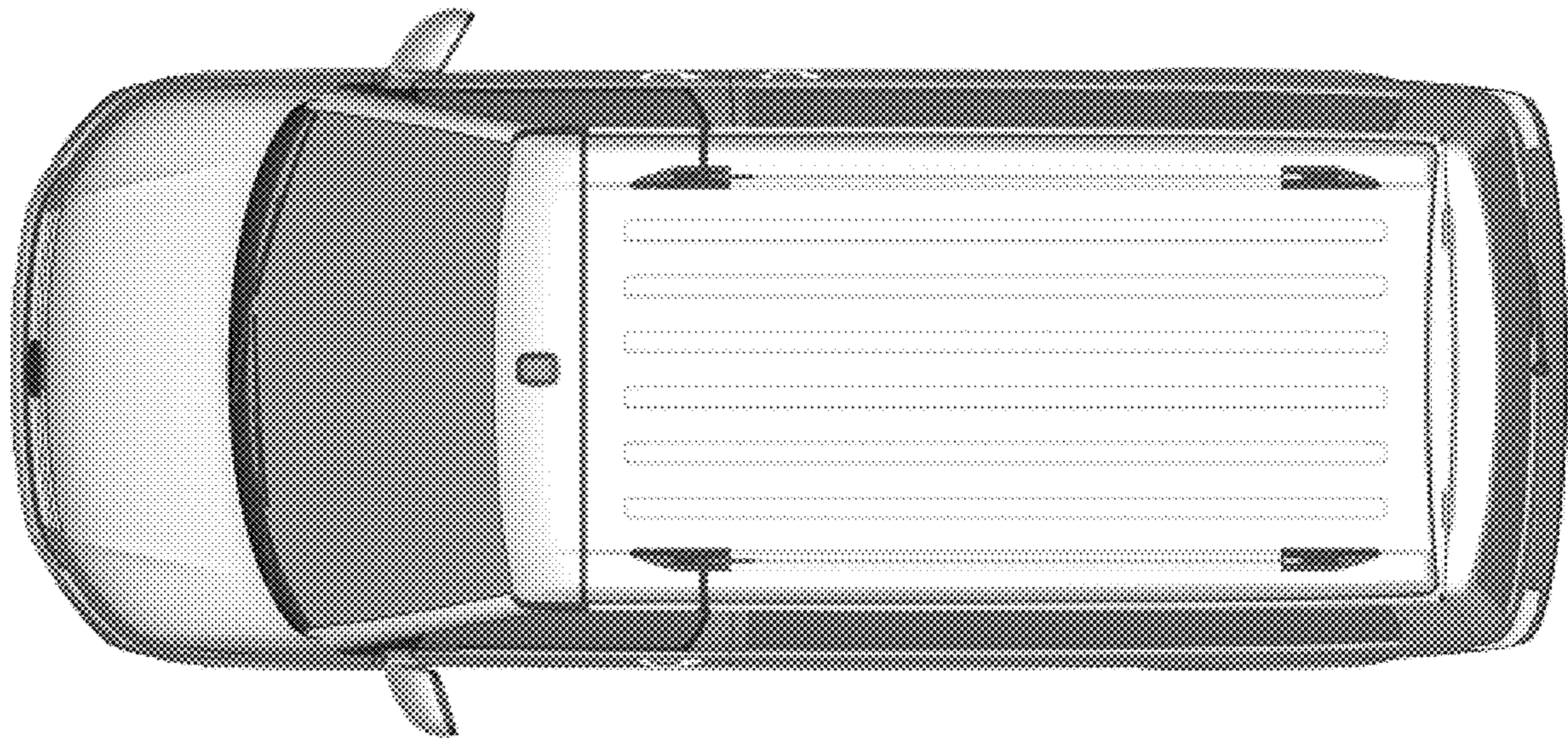

FIG. 9