



US00D899281S

(12) **United States Design Patent** (10) **Patent No.:** **US D899,281 S**
Takano (45) **Date of Patent:** **** Oct. 20, 2020**

(54) **GAS ANALYZER**

(71) Applicant: **YOKOGAWA ELECTRIC CORPORATION**, Musashino-shi, Tokyo (JP)

(72) Inventor: **Naoto Takano**, Tokyo (JP)

(73) Assignee: **YOKOGAWA ELECTRIC CORPORATION** (JP)

(**) Term: **15 Years**

(21) Appl. No.: **29/723,665**

(22) Filed: **Feb. 10, 2020**

Related U.S. Application Data

(62) Division of application No. 35/506,210, filed on Jun. 8, 2018 (U.S. filing date under 35 U.S.C. 384), and having an international filing date of Jun. 8, 2018, now Pat. No. Des. 878,228.

(51) **LOC (12) Cl.** **10-04**

(52) **U.S. Cl.**
USPC **D10/81**

(58) **Field of Classification Search**
USPC D10/81, 96, 78; D23/355, 235
CPC A61M 11/06
See application file for complete search history.

(56) **References Cited**

U.S. PATENT DOCUMENTS

D375,056 S *	10/1996	Sewell	D10/96
5,797,389 A *	8/1998	Ryder	A61M 11/06
			128/200.21
D485,771 S *	1/2004	Ribeiro	D10/81
D499,347 S *	12/2004	Fudali	D10/78
D762,504 S *	8/2016	Senba	D10/81
D862,646 S *	10/2019	Jorgensen	D23/235
D884,523 S *	5/2020	Seimori	D10/81
D890,898 S *	7/2020	Nibbelink	D23/355

* cited by examiner

Primary Examiner — George D. Kirschbaum
(74) *Attorney, Agent, or Firm* — Saidman DesignLaw Group, LLC

(57) **CLAIM**

The ornamental design for a gas analyzer, as shown and described.

DESCRIPTION

FIG. 1 is a perspective view of a gas analyzer showing my new design;
FIG. 2 is a front view thereof;
FIG. 3 is a rear view thereof;
FIG. 4 is a top view thereof;
FIG. 5 is a bottom view thereof;
FIG. 6 is a left side view thereof; and,
FIG. 7 is a right side view thereof.
The broken lines do not form part of the claimed design.

1 Claim, 7 Drawing Sheets

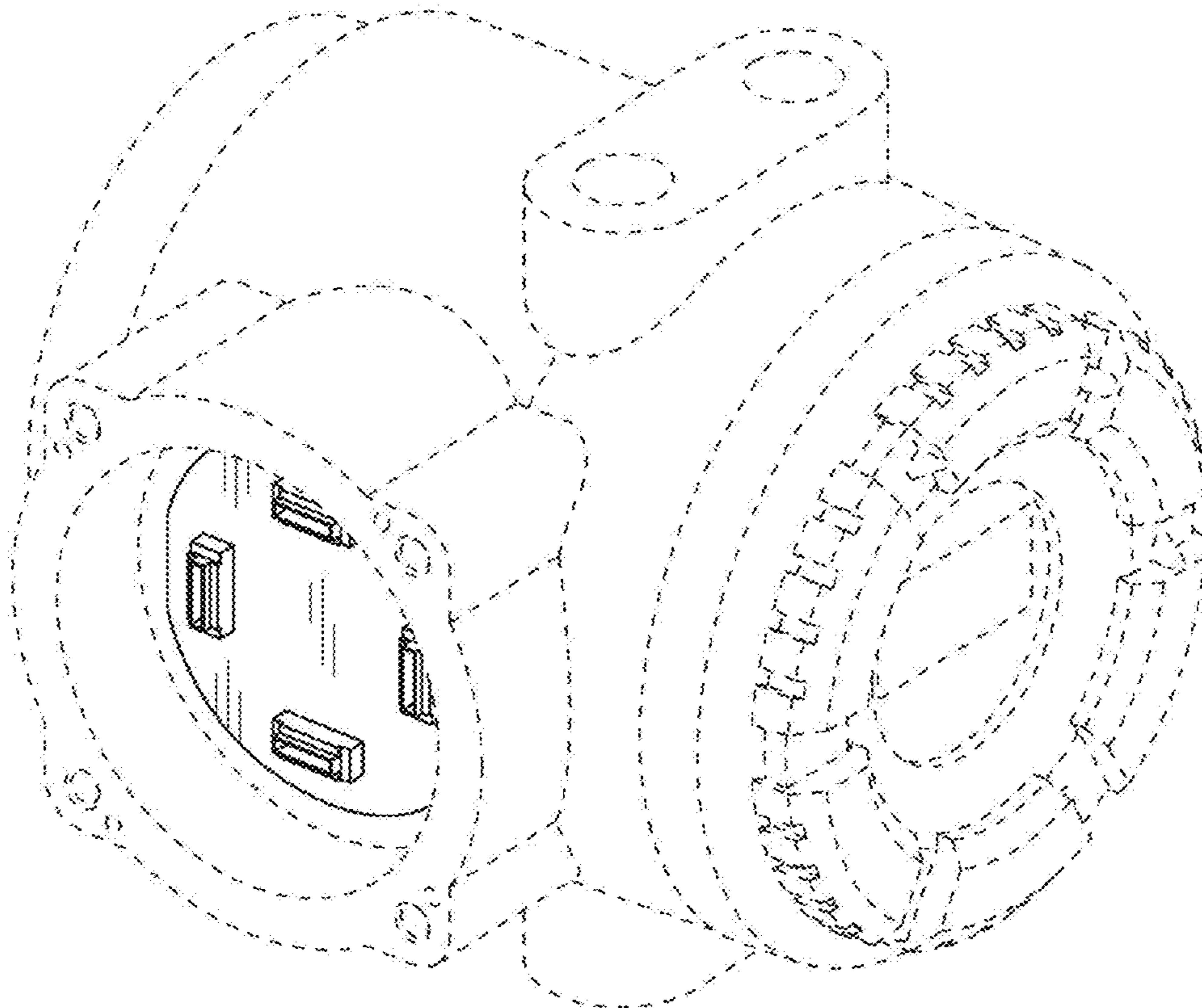

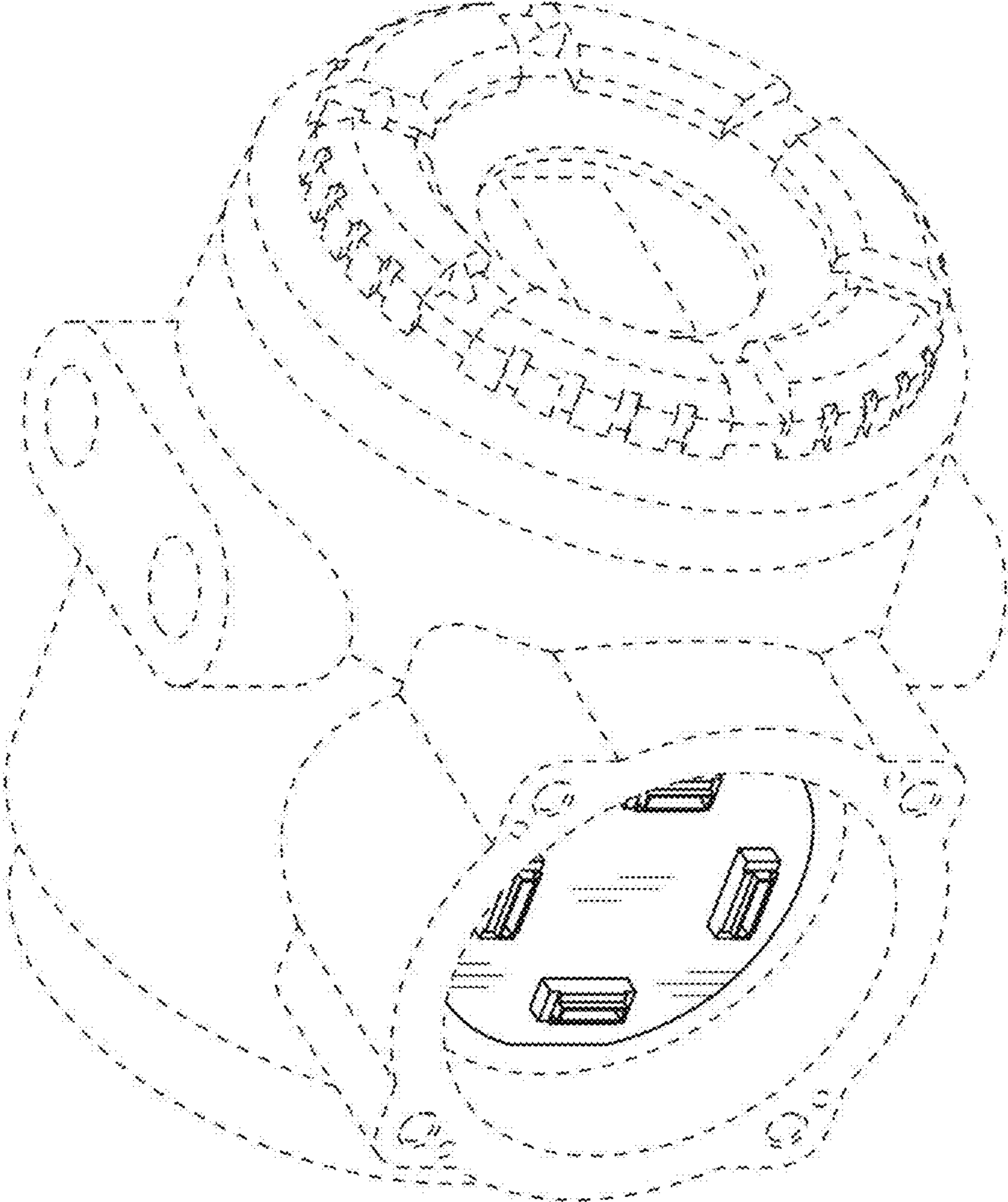

FIG. 1

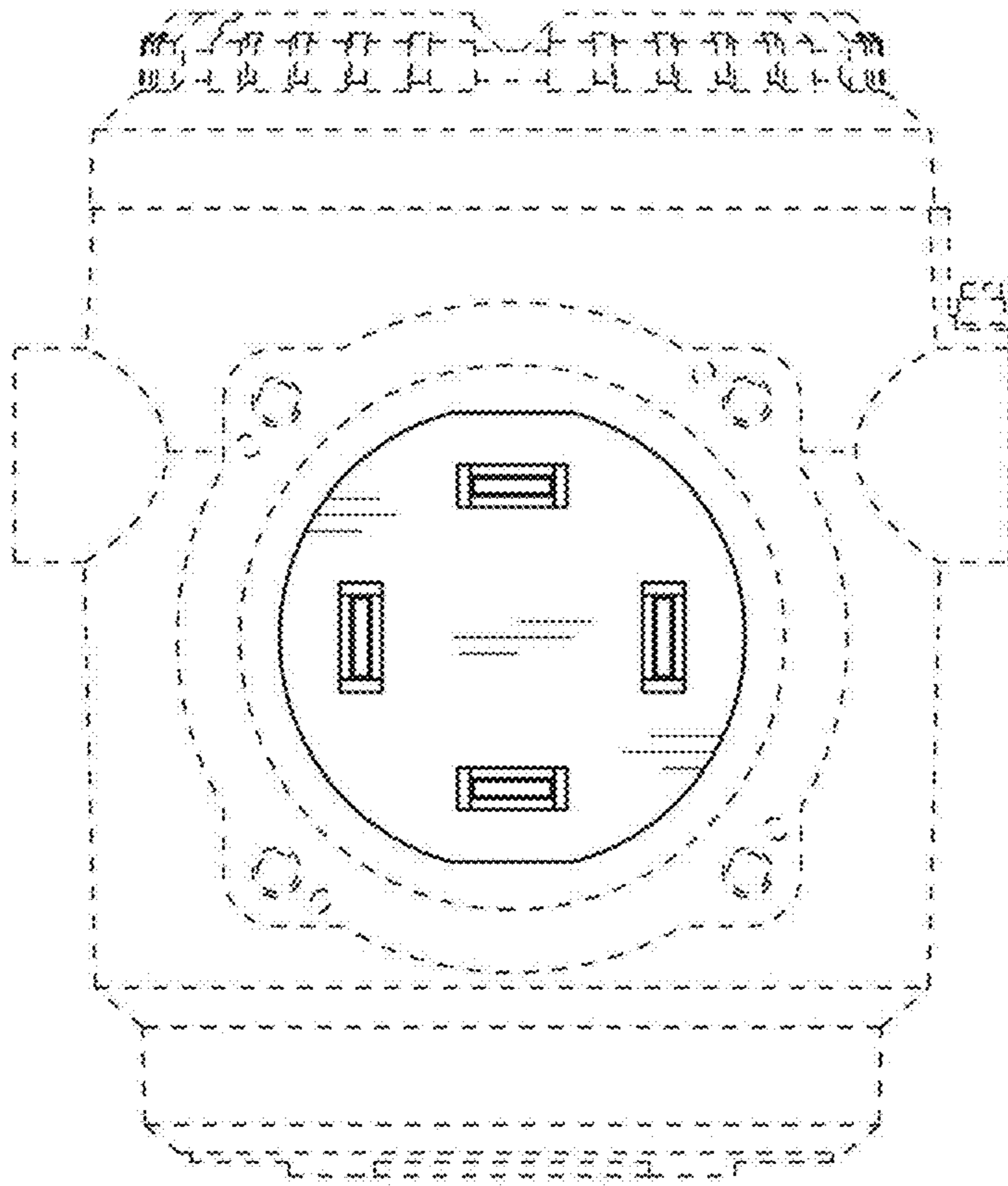

FIG. 2

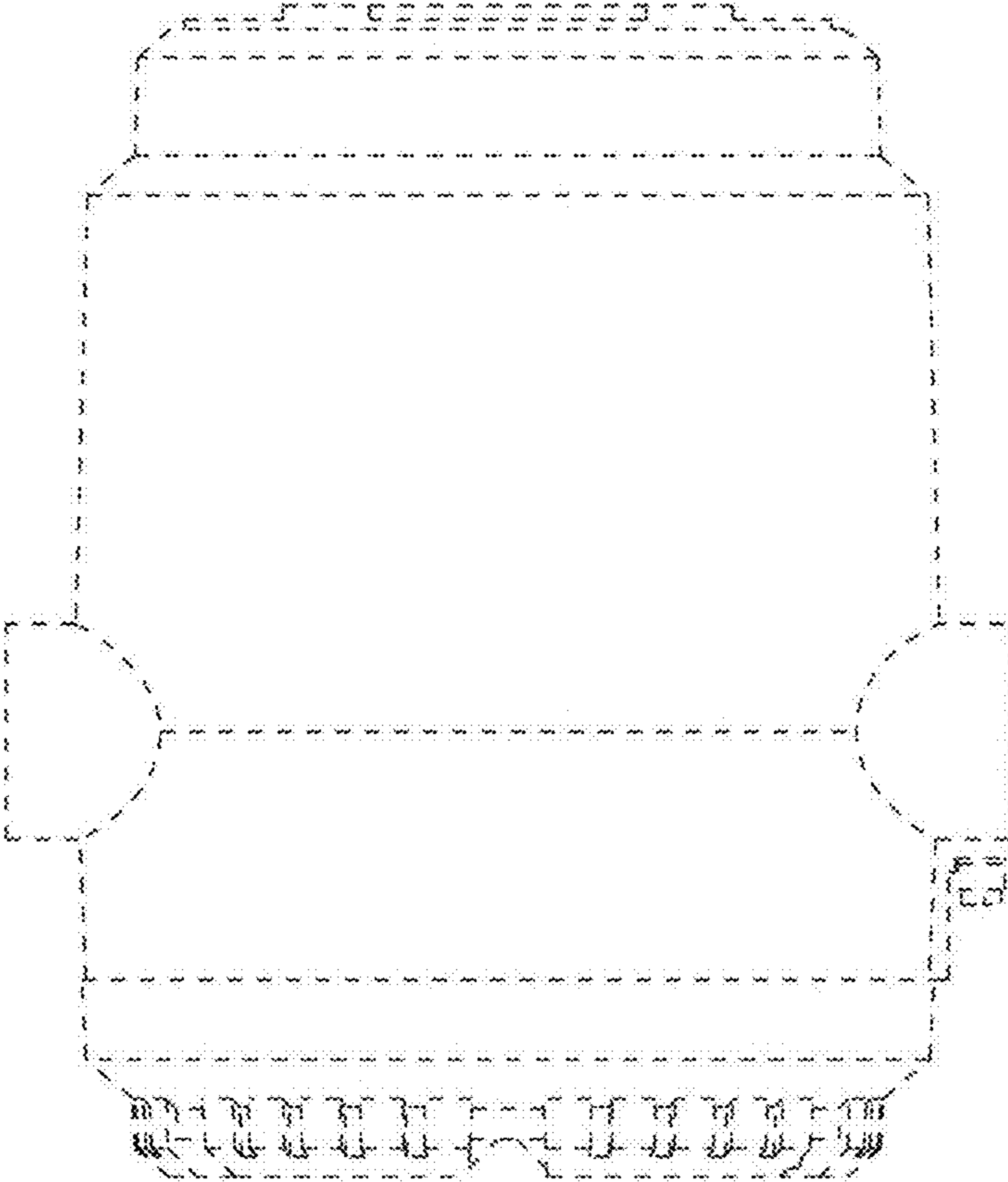

FIG. 3

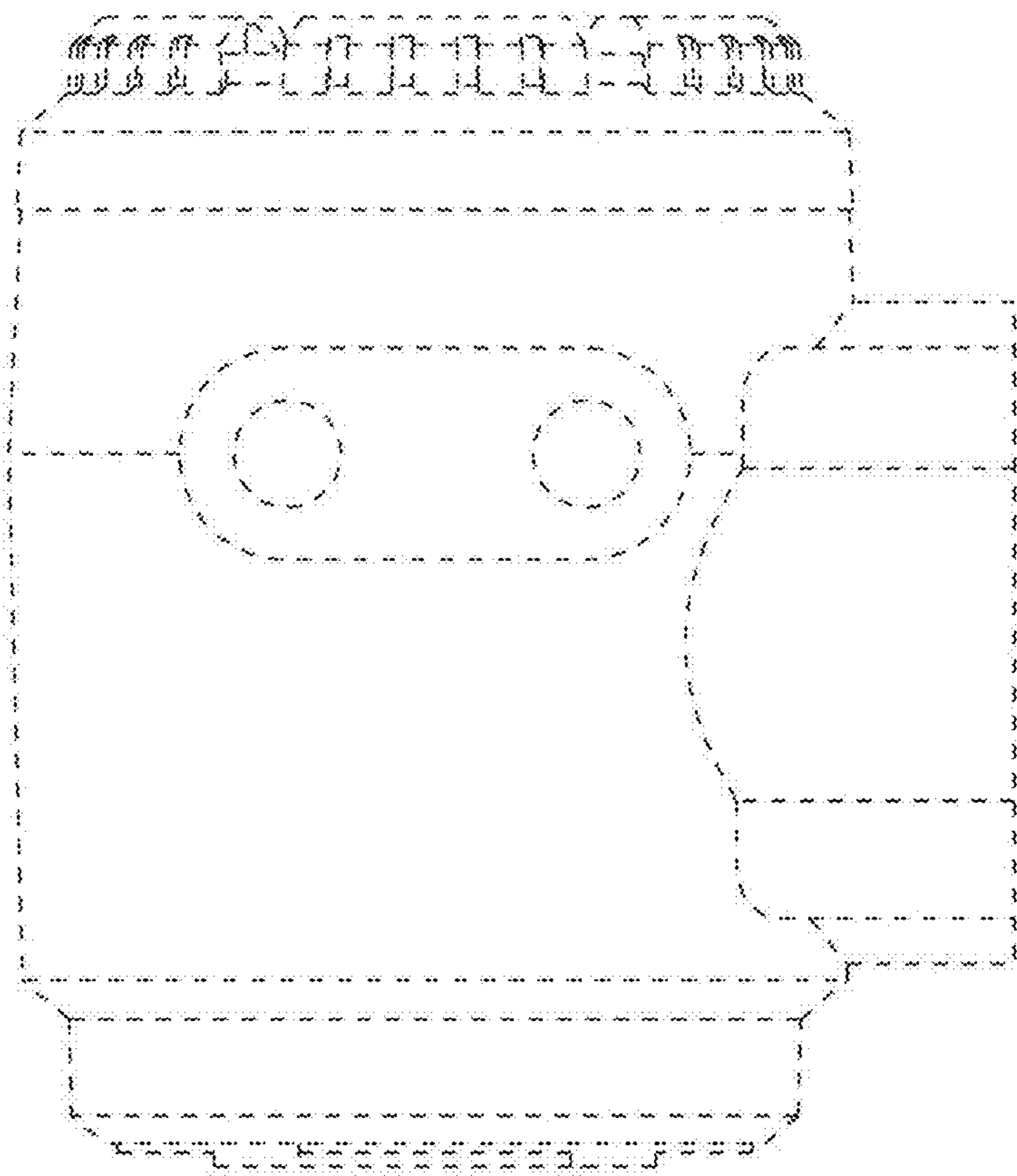

FIG. 4

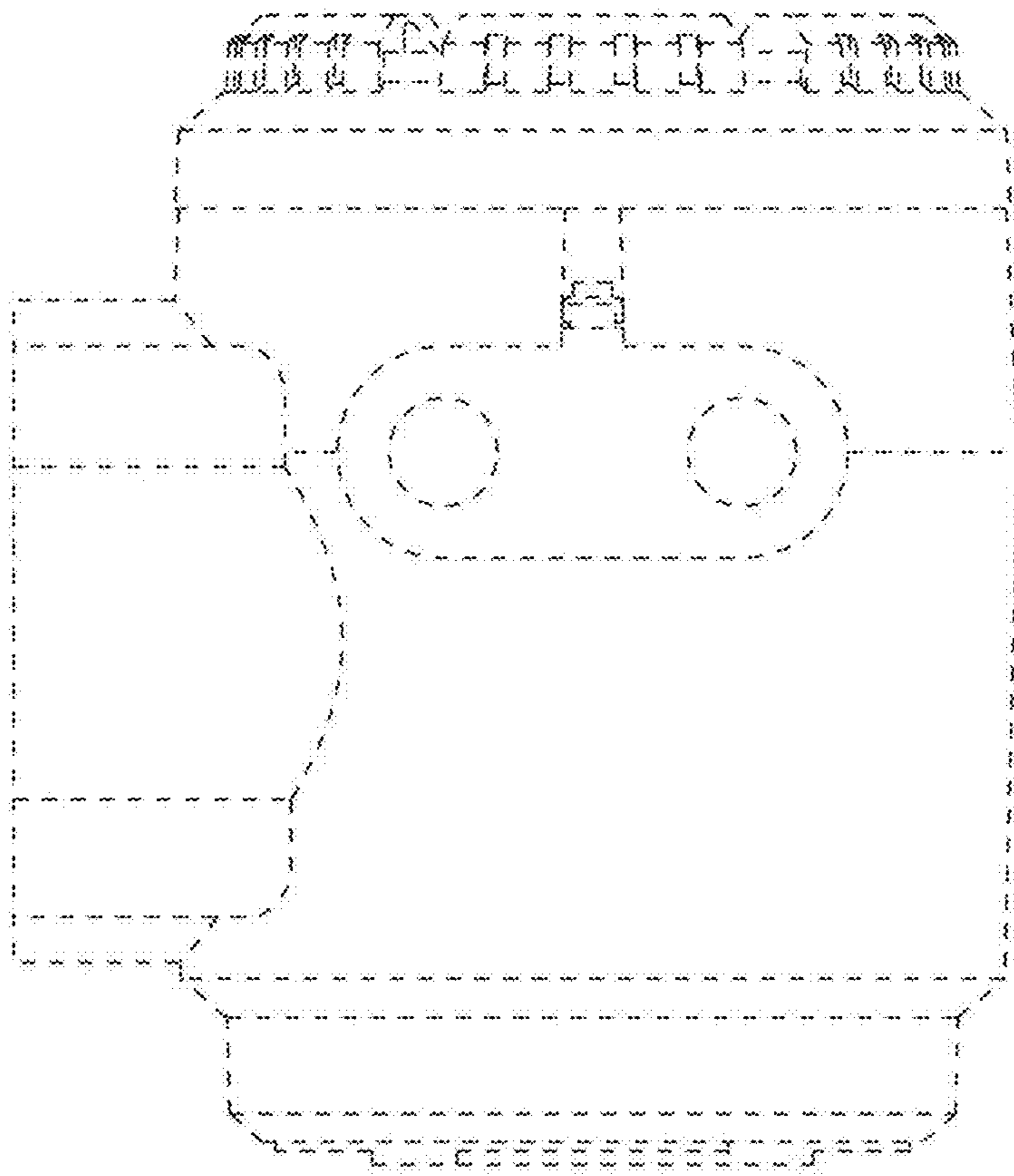

FIG. 5

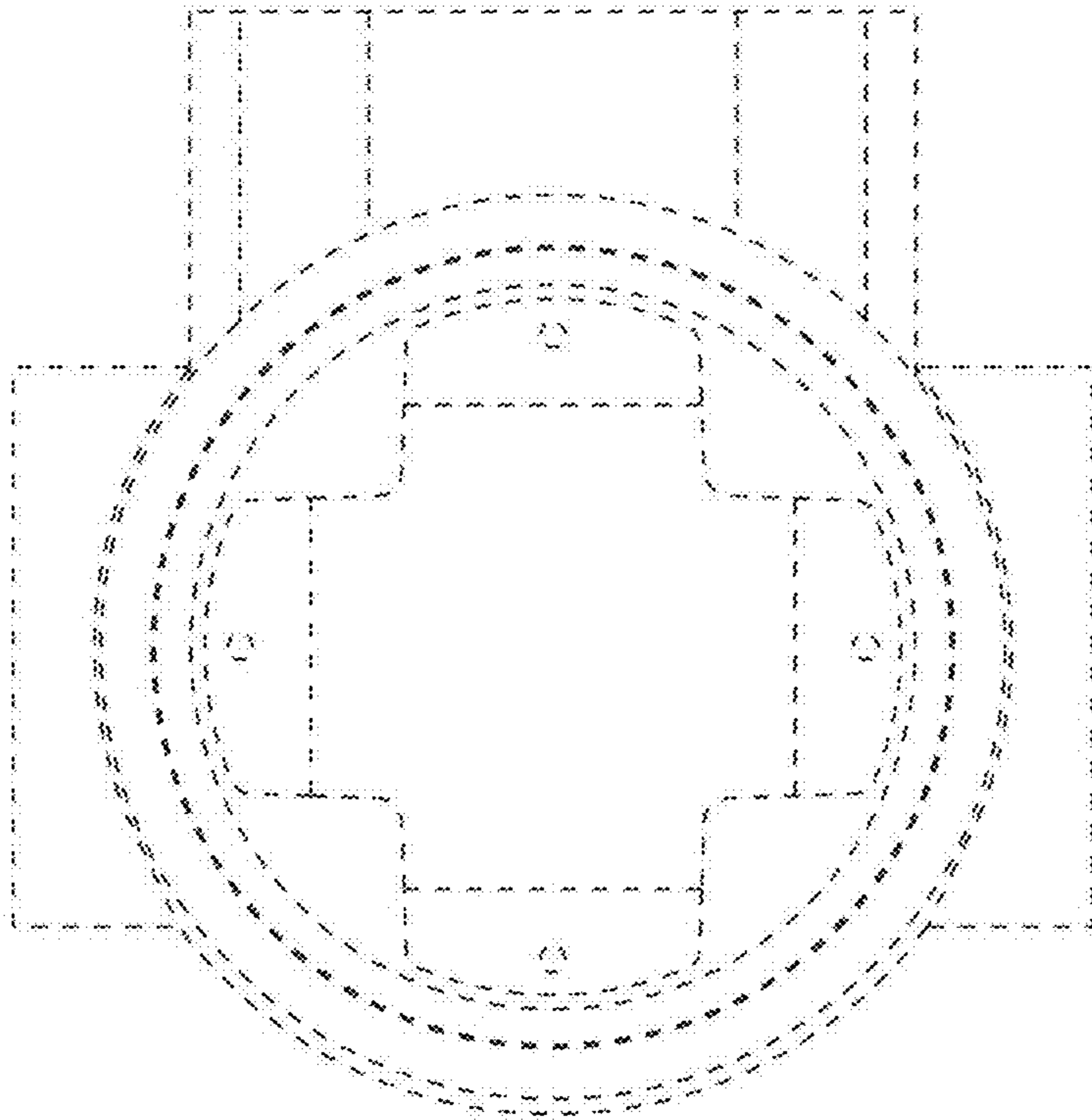

FIG. 6

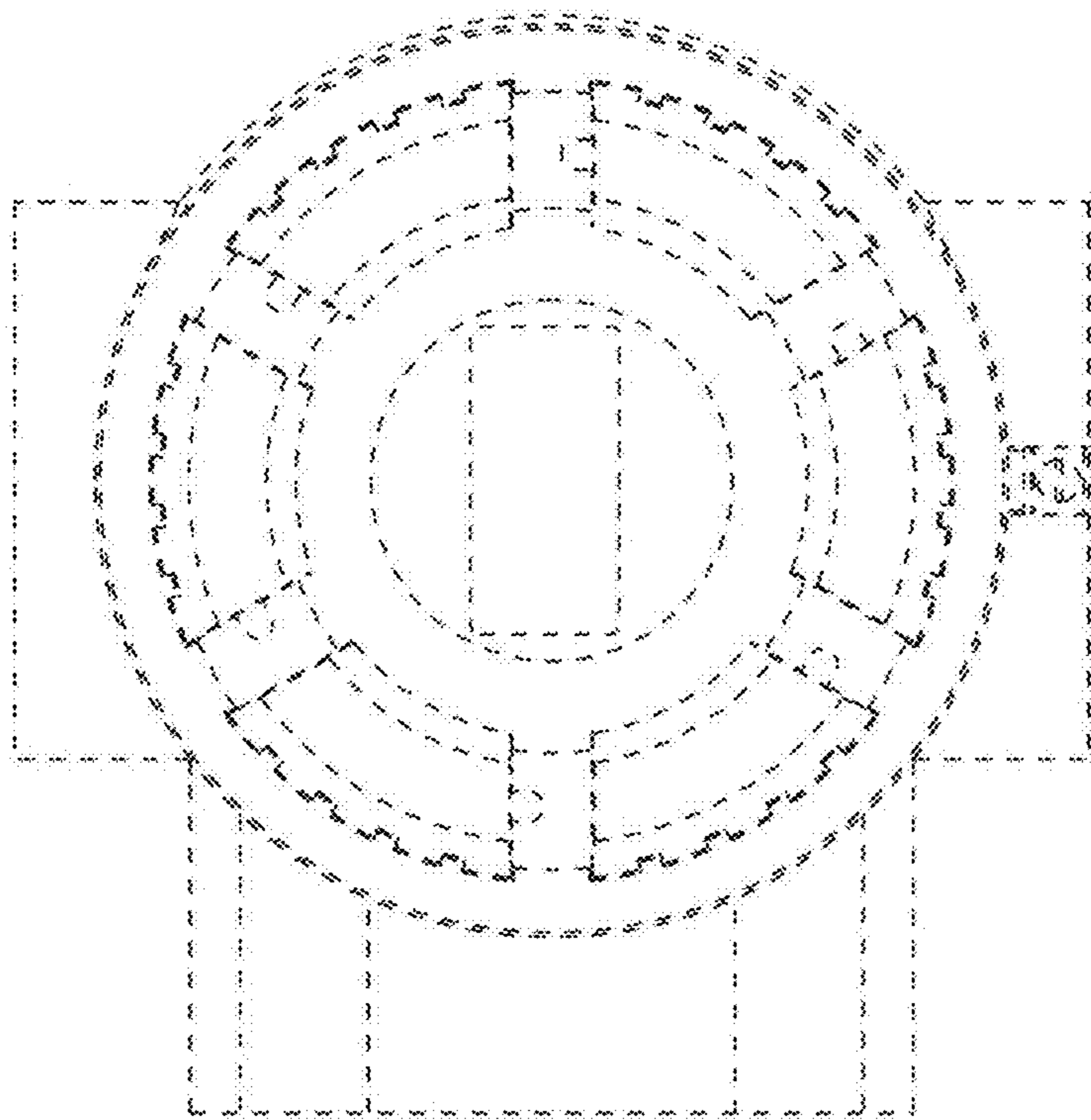

FIG. 7