



US00D899221S

(12) **United States Design Patent** (10) **Patent No.:** **US D899,221 S**
Malcolm (45) **Date of Patent:** **** Oct. 20, 2020**

(54) **STRUCTURAL STIFFENING MEMBER**

(71) Applicant: **Roger J. Malcolm**, San Clemente, CA (US)

(72) Inventor: **Roger J. Malcolm**, San Clemente, CA (US)

(**) Term: **15 Years**

(21) Appl. No.: **29/613,709**

(22) Filed: **Aug. 11, 2017**

(51) **LOC (12) Cl.** **08-05**

(52) **U.S. Cl.**
USPC **D8/354**

(58) **Field of Classification Search**
USPC D8/349, 350, 353, 354, 355, 373, 374, D8/376, 377, 380, 381, 382, 394-396; D25/119-125, 136, 164, 138; D12/223; 114/102.24
CPC B63H 8/40
See application file for complete search history.

(56) **References Cited**

U.S. PATENT DOCUMENTS

2,388,221	A *	10/1945	Smith	G07D 9/004 453/50
2,608,172	A *	8/1952	Biuw	B63H 9/065 114/102.27
3,581,698	A *	6/1971	Bete	B63H 9/065 114/102.27
3,905,321	A *	9/1975	Blythe, Jr.	B63H 9/065 114/102.27
4,487,146	A	12/1984	Parmentier		
4,633,798	A *	1/1987	Skinner	B63H 9/065 114/107
4,864,953	A *	9/1989	Allsopp	B63H 9/065 114/102.27
4,996,801	A *	3/1991	Ristow	E04D 5/142 52/273

(Continued)

Primary Examiner — Janice Hallmark

Assistant Examiner — Harold E Blackwell, II

(74) *Attorney, Agent, or Firm* — Charmasson, Buchara & Leach, LLP

(57) **CLAIM**

The ornamental design for a structural stiffening member, as shown and described.

DESCRIPTION

FIG. 1 is a front elevational view of a structural stiffening member showing an embodiment of my new design, the back elevational view being a mirror image thereof.

FIG. 2 is a left side elevational view thereof, the right side elevational view being a mirror image thereof.

FIG. 3 is a top plan view thereof.

FIG. 4 is an enlarged top plan view thereof.

FIG. 5 is a bottom plan view thereof.

FIG. 6 is an enlarged bottom plan view thereof.

FIG. 7 is a cross-sectional bottom view of the member of FIG. 1 taken by a plane perpendicular to the elongation axis of the member on line 7-7.

FIG. 8 is an enlarged view of FIG. 7.

FIG. 9 is a front elevational view of a structural stiffening member showing an alternate embodiment of my new design, the back elevational view being a mirror image thereof.

FIG. 10 is a left side elevational view thereof, the right side elevational view being a mirror image thereof.

FIG. 11 is a top plan view thereof.

FIG. 12 is an enlarged top plan view thereof.

FIG. 13 is a bottom plan view thereof.

FIG. 14 is an enlarged bottom plan view thereof.

FIG. 15 is a cross-sectional bottom view of the member of FIG. 9 taken by a plane perpendicular to the elongation axis of the member on line 15-15; and,

FIG. 16 is an enlarged view of FIG. 15.

Shading lines are used to show solid structures and are not intended to indicate surface decoration.

1 Claim, 2 Drawing Sheets

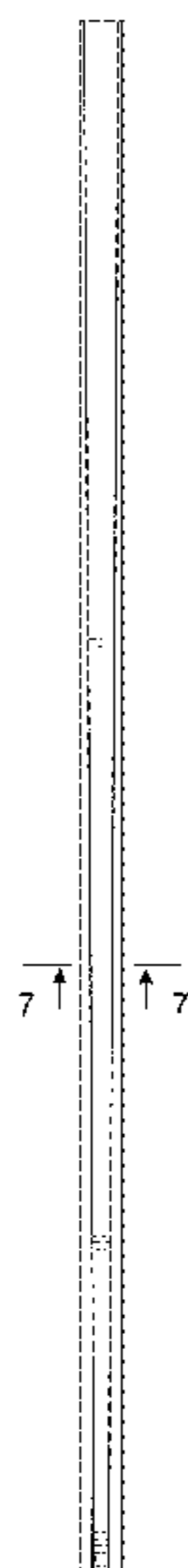

(56)

References Cited

U.S. PATENT DOCUMENTS

5,056,449 A 10/1991 Howlett
5,146,864 A * 9/1992 Harrington B63H 9/065
114/102.27
5,178,086 A * 1/1993 Ross B63H 9/065
114/102.31
D336,687 S * 6/1993 Schremmer D25/138
5,413,060 A 5/1995 Quigley
D465,291 S * 11/2002 Marshall D25/119
6,899,047 B2 * 5/2005 Countouris B29C 70/30
114/90
D535,844 S * 1/2007 Siegel D6/577
D616,951 S * 6/2010 Imamura D21/692
D619,886 S * 7/2010 Heindl D8/382
D799,067 S * 10/2017 Forsberg D25/119
10,315,745 B2 * 6/2019 Malcolm B63H 9/065
D863,818 S * 10/2019 Chen D6/580
D871,107 S * 12/2019 Chen D6/580
2016/0221656 A1 8/2016 Dogliotti et al.

* cited by examiner

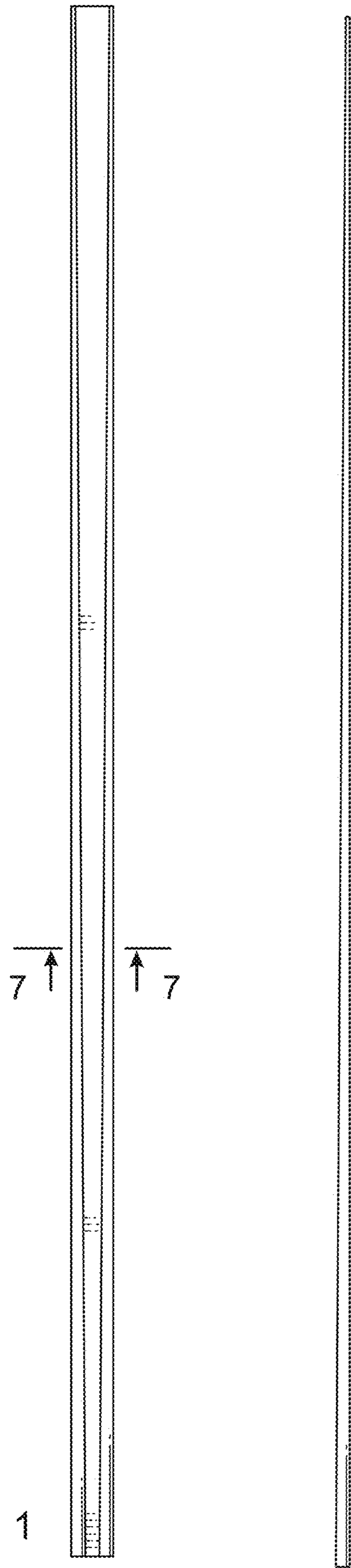

FIG. 1

FIG. 2

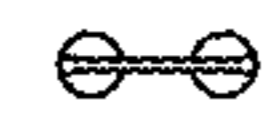

FIG. 3

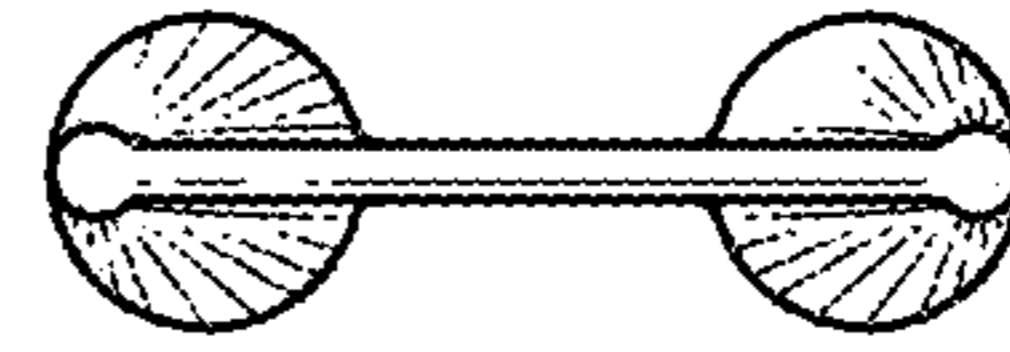

FIG. 4

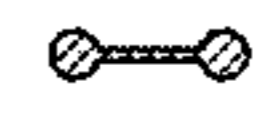

FIG. 7

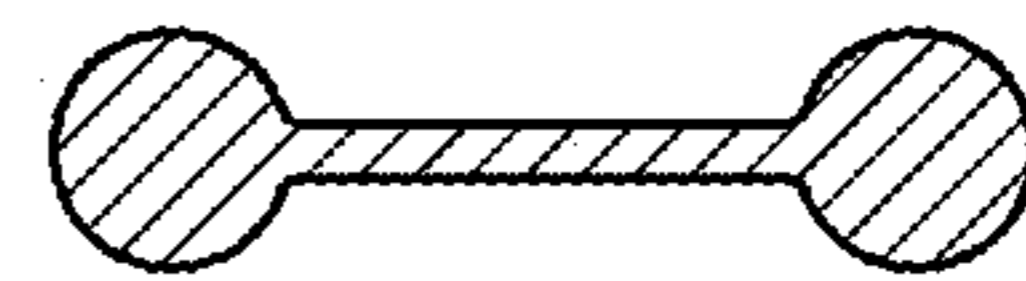

FIG. 8

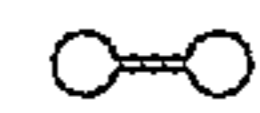

FIG. 5

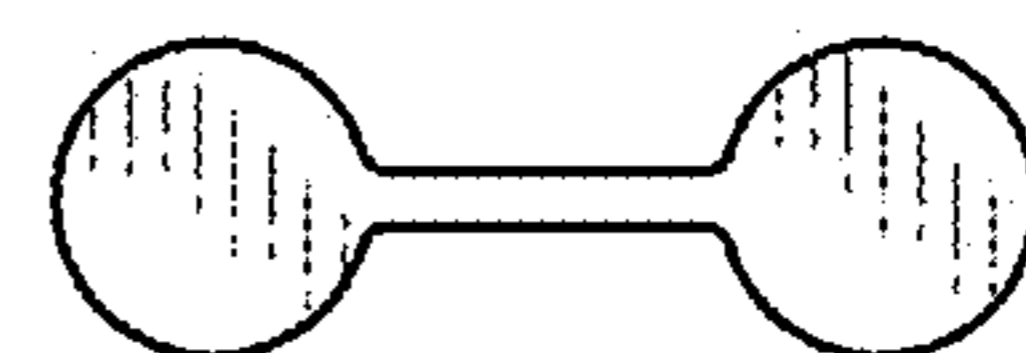

FIG. 6

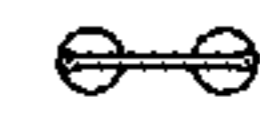
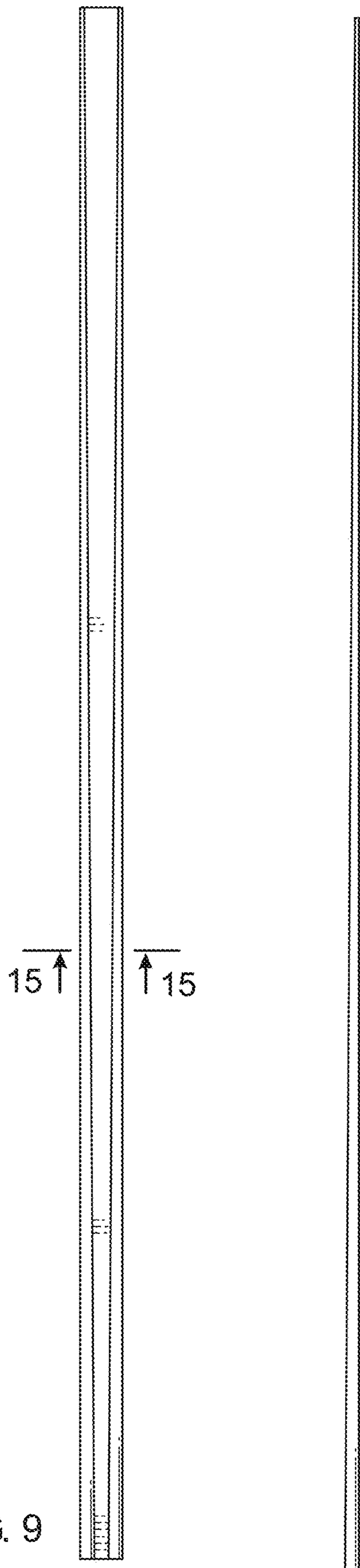

FIG. 11

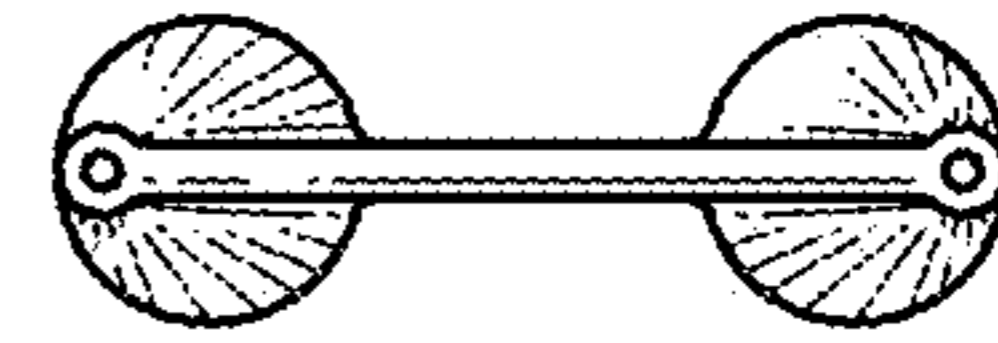

FIG. 12

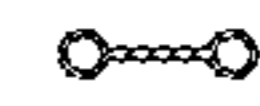

FIG. 15

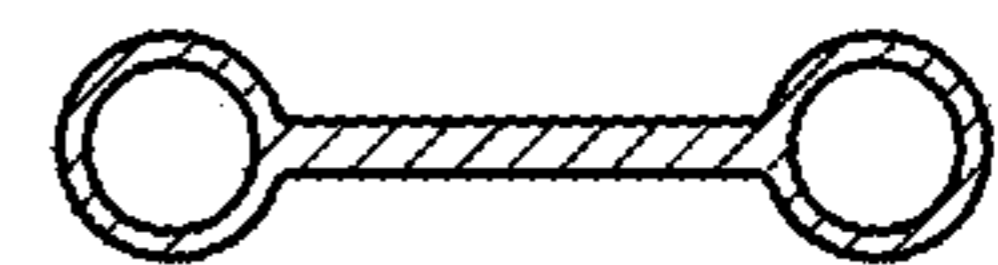

FIG. 16



FIG. 13

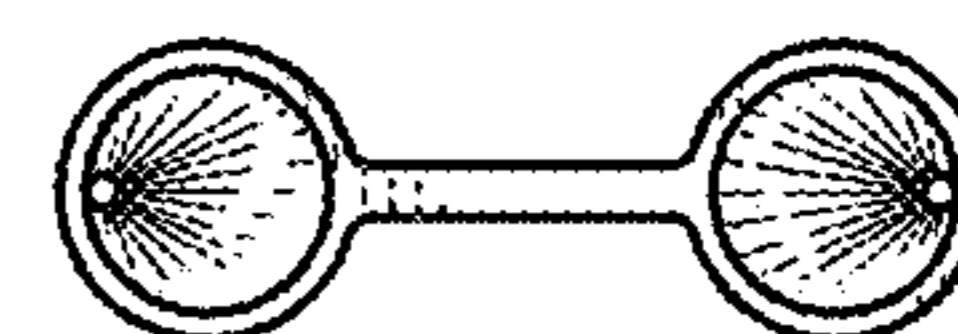

FIG. 14