



US00D899174S

(12) **United States Design Patent**
Gordon et al.

(10) **Patent No.:** **US D899,174 S**
(45) **Date of Patent:** **** Oct. 20, 2020**

- (54) **KETTLE**
- (71) Applicant: **Sunbeam Products, Inc.**, Boca Raton, FL (US)
- (72) Inventors: **Stewart Gordon**, Cheadle (GB); **Noel Disbury**, Manchester (GB); **Nick Brook**, Sale (GB); **Mark Skinner**, Salford (GB)
- (73) Assignee: **Sunbeam Products, Inc.**, Boca Raton, FL (US)

D818,756 S * 5/2018 Averty D7/318
 D829,034 S * 9/2018 Barquin D7/318
 2012/0145698 A1* 6/2012 Von Seidel A47J 27/21016
 219/438

(**) Term: **15 Years**

(21) Appl. No.: **29/643,966**

(22) Filed: **Apr. 13, 2018**

(51) **LOC (12) Cl.** **07-01**

(52) **U.S. Cl.**
USPC **D7/318**

(58) **Field of Classification Search**
 USPC D7/300, 312, 316-319, 322, 598, 600,
 D7/602; D9/516, 530, 531, 544, 545,
 D9/546, 559, 569
 CPC A47J 127/21; A47J 127/21008; A47J
 127/21041; A47J 31/00; A47G 19/14
 See application file for complete search history.

(56) **References Cited**

U.S. PATENT DOCUMENTS

D445,628 S * 7/2001 McGroary D7/317
 D454,469 S * 3/2002 Jalet D7/316
 D498,384 S * 11/2004 McWilliam D7/317
 D726,486 S * 4/2015 Averty D7/312
 D777,500 S * 1/2017 Lee D7/317

OTHER PUBLICATIONS

Kettle posted at target.com, review posted on Sep. 11, 2018, © 2018 Target.com, [online], [site visited Jul. 2, 2019]. Available from Internet, URL: <https://www.target.com.au/p/sunbeam-1-71-coastal-kettle-ke25-ws/61526778> (Year: 2018).*

* cited by examiner

Primary Examiner — Susan E Krakower

Assistant Examiner — Andrew Kerr

(74) *Attorney, Agent, or Firm* — Husch Blackwell LLP

(57) **CLAIM**

The ornamental design for a kettle, as shown and described.

DESCRIPTION

FIG. 1 depicts a front perspective view of a kettle of the present disclosure;

FIG. 2 depicts an enlarged detail view of portion 2 shown in FIG. 1.

FIG. 3 depicts a front side view of the kettle of FIG. 1;

FIG. 4 depicts a rear side view of the kettle of FIG. 1;

FIG. 5 depicts a right side view of the kettle of FIG. 1;

FIG. 6 depicts a left side view of the kettle of FIG. 1;

FIG. 7 depicts a top view of the kettle of FIG. 1; and,

FIG. 8 depicts a bottom view of the kettle of FIG. 1.

The broken lines in the drawings depict portions of the kettle that form no part of the claimed design.

1 Claim, 5 Drawing Sheets

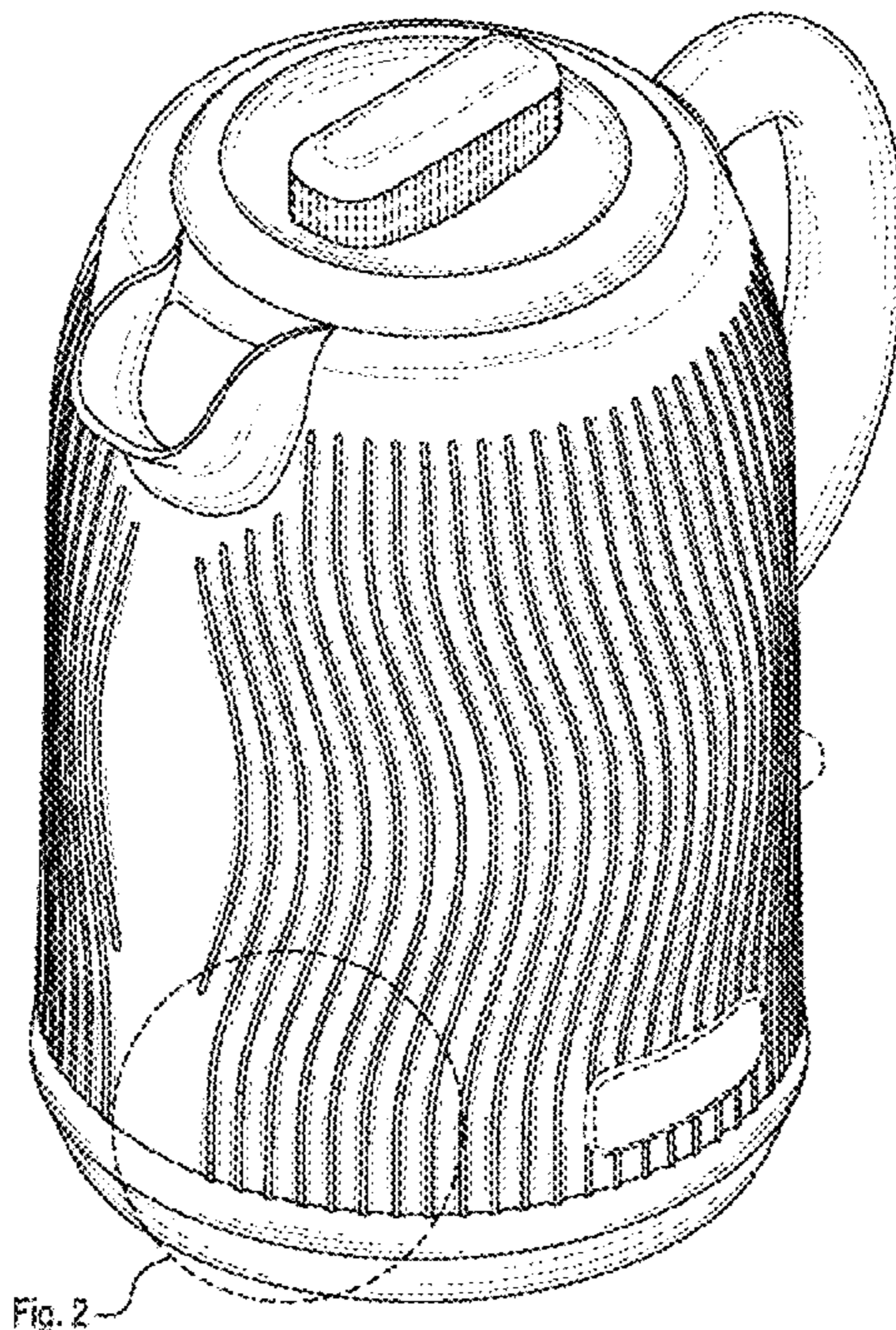

FIG. 1

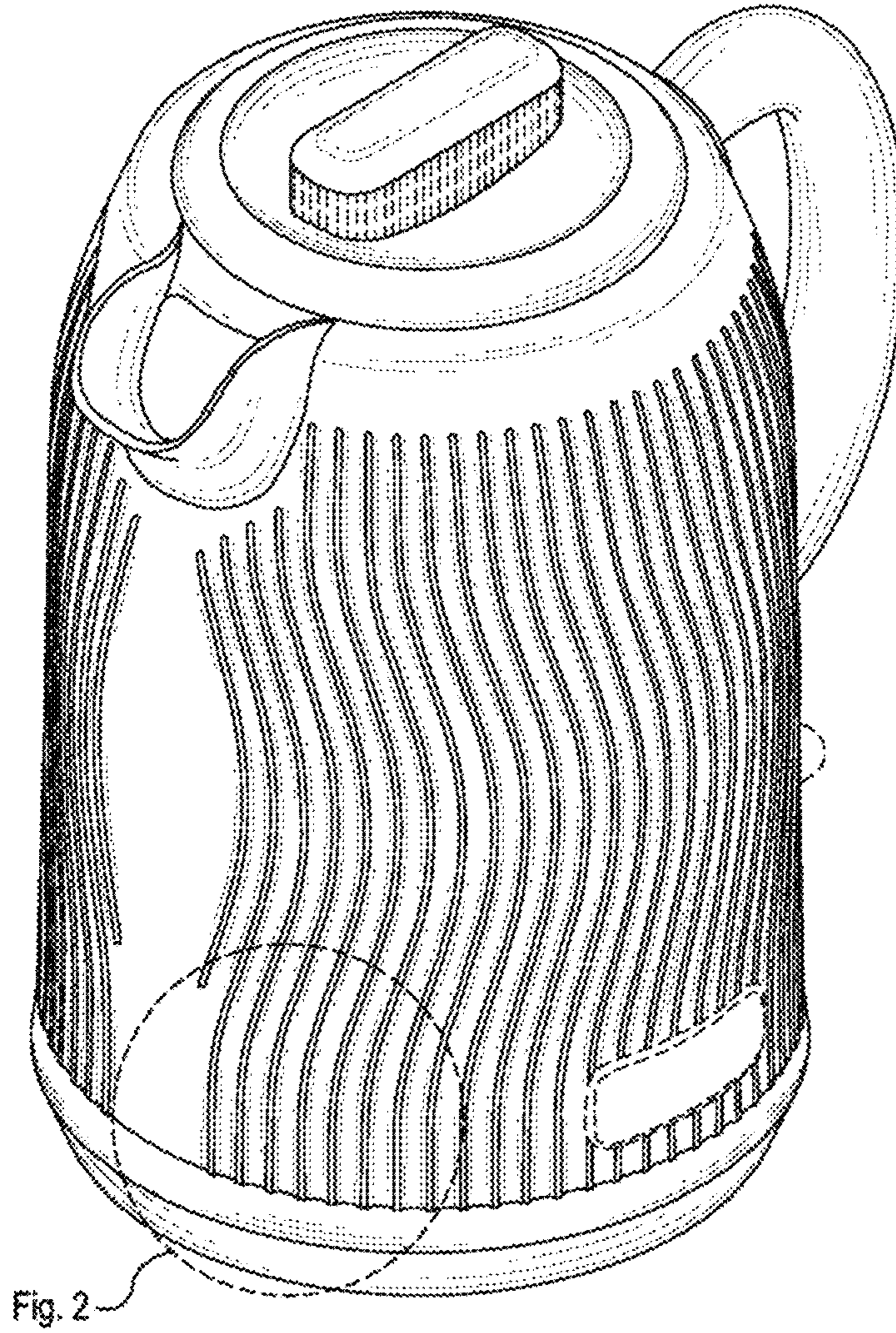

FIG. 2

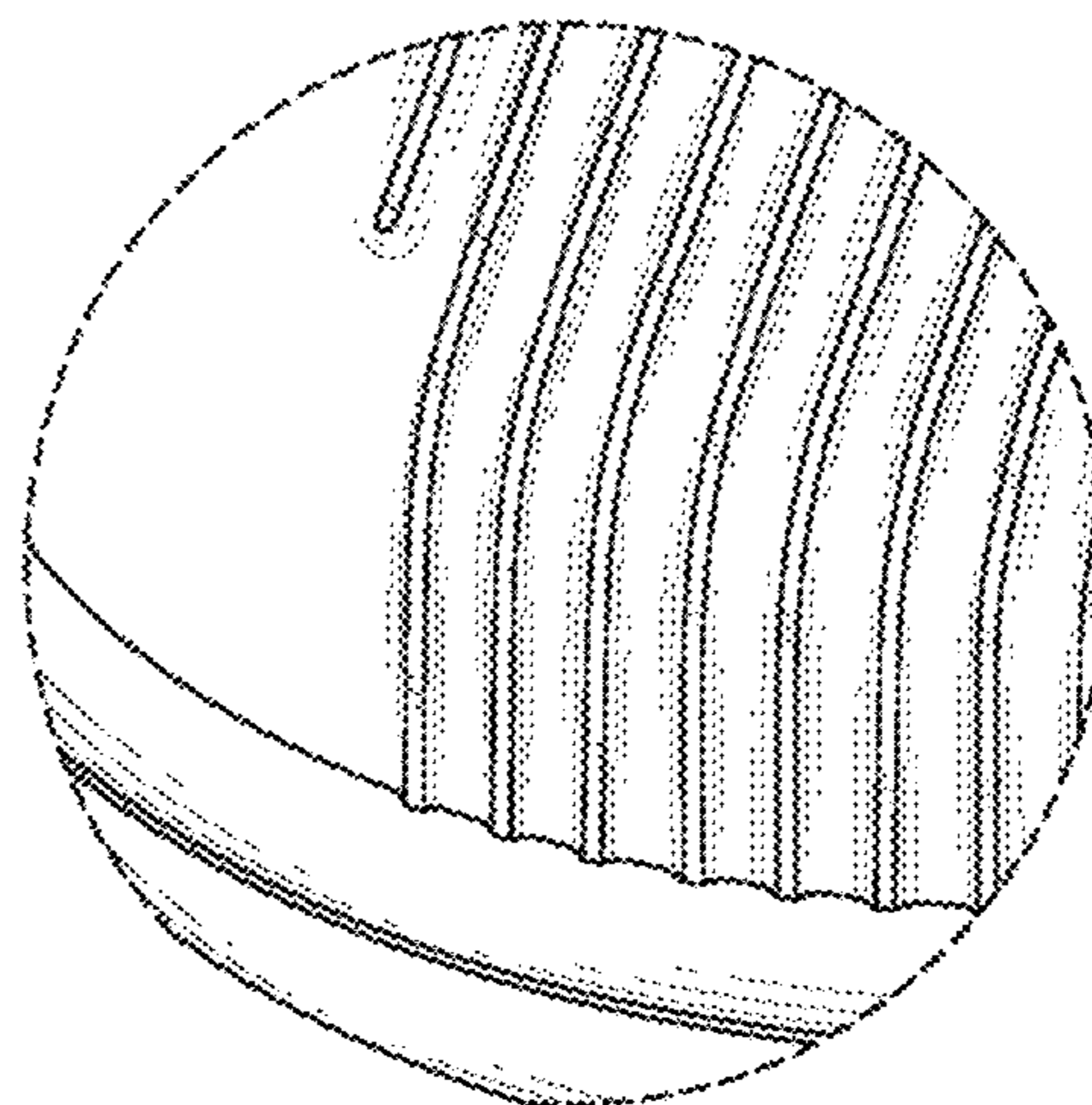

FIG. 4

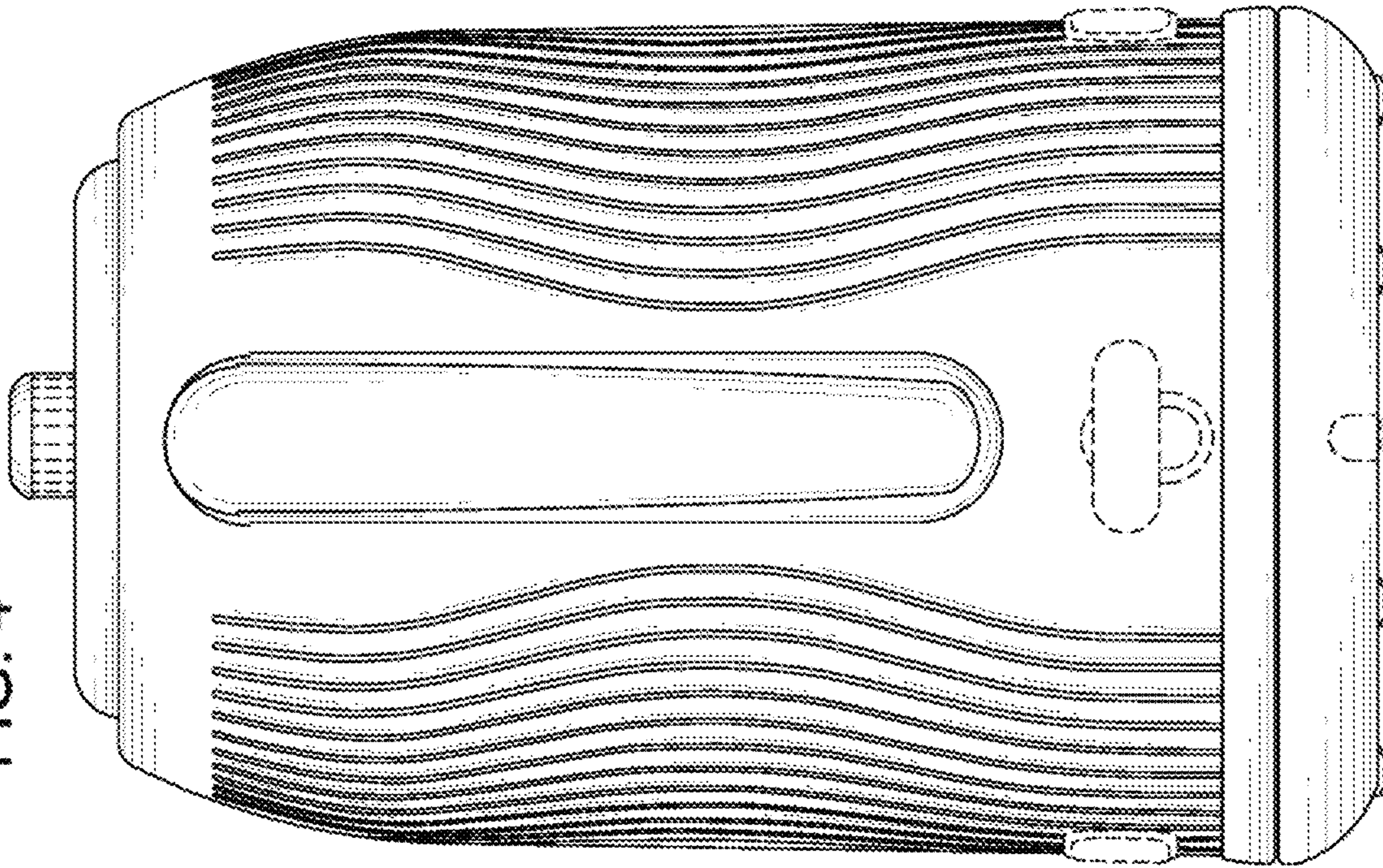

FIG. 3

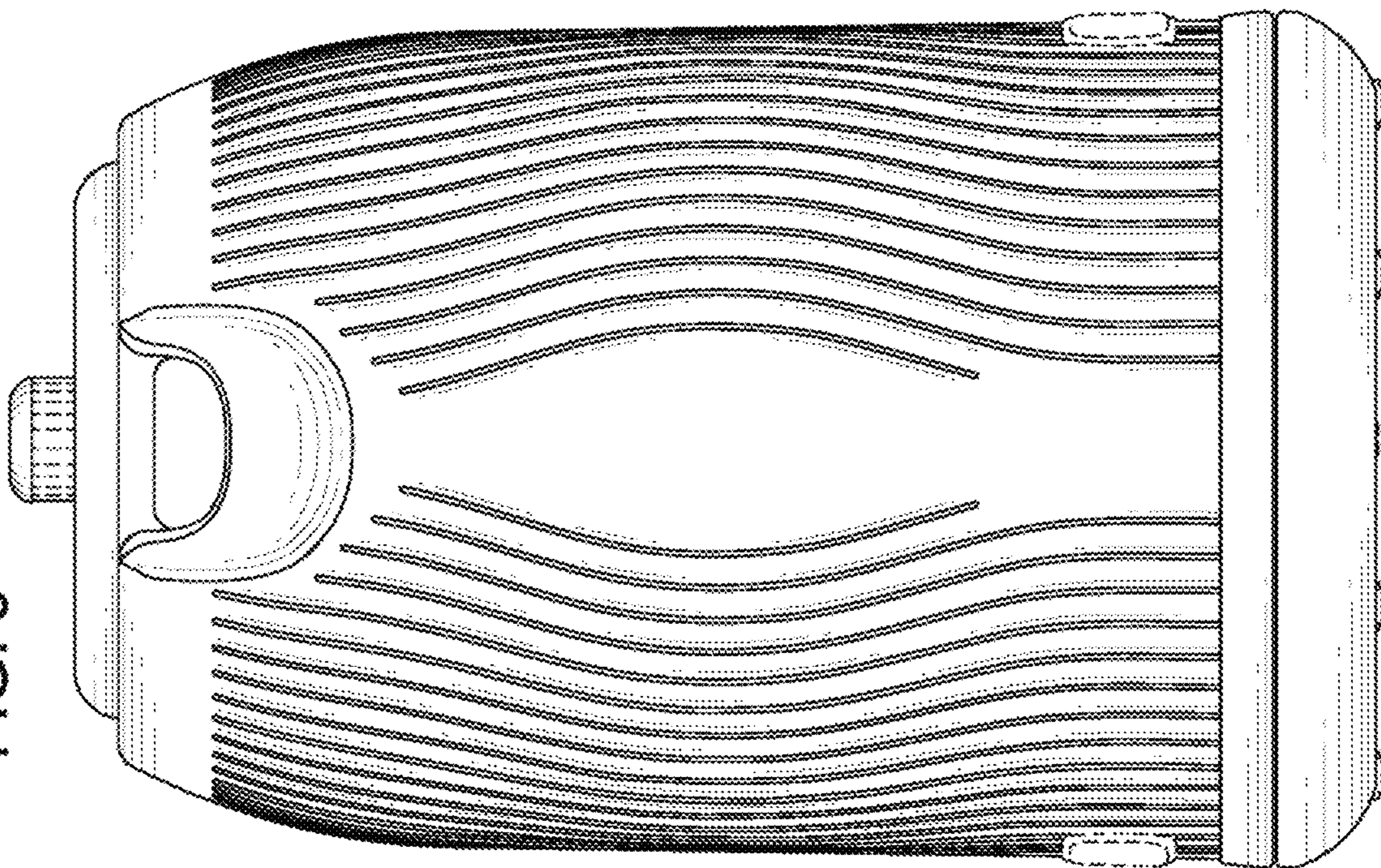

FIG. 5

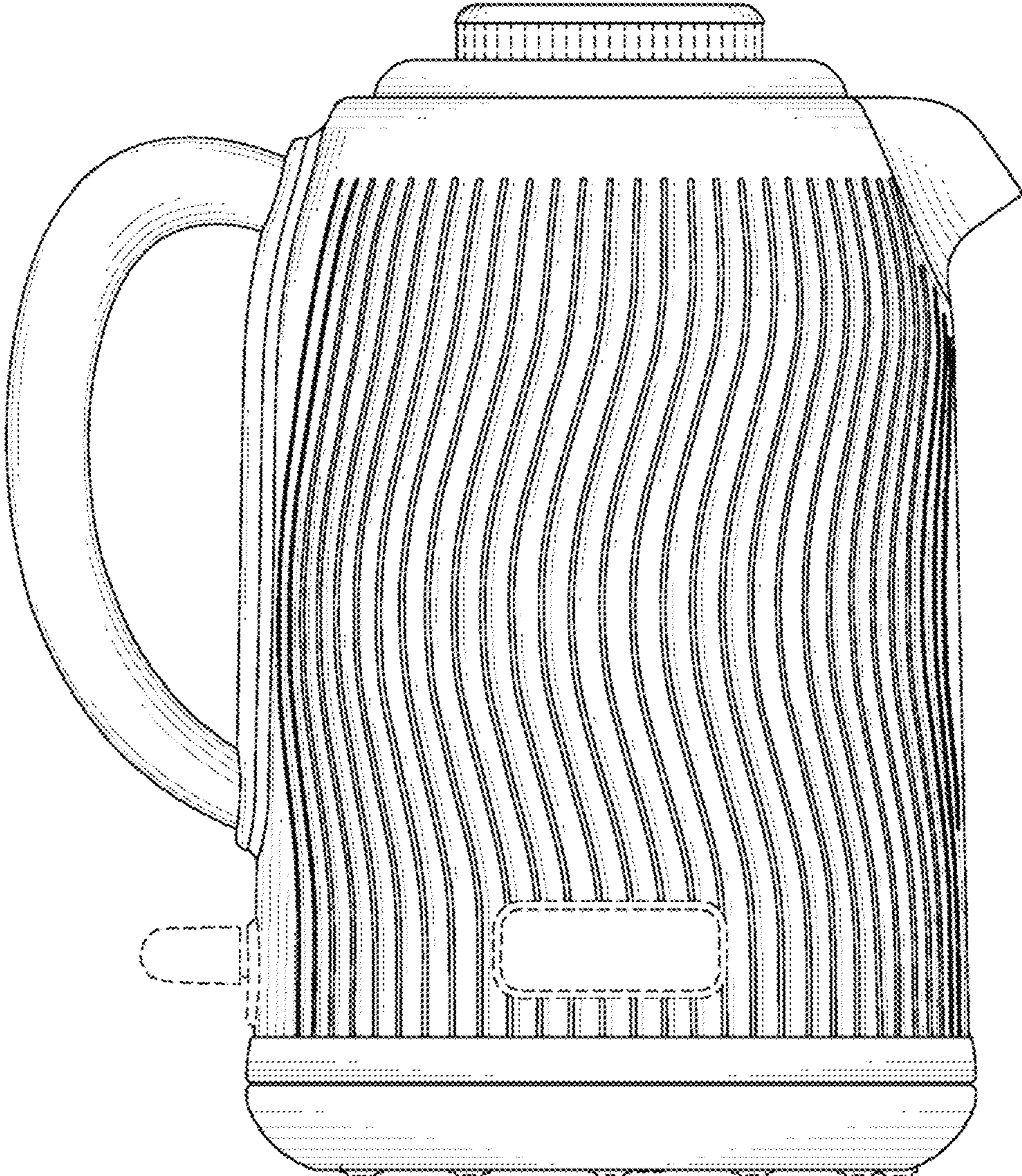

FIG. 6

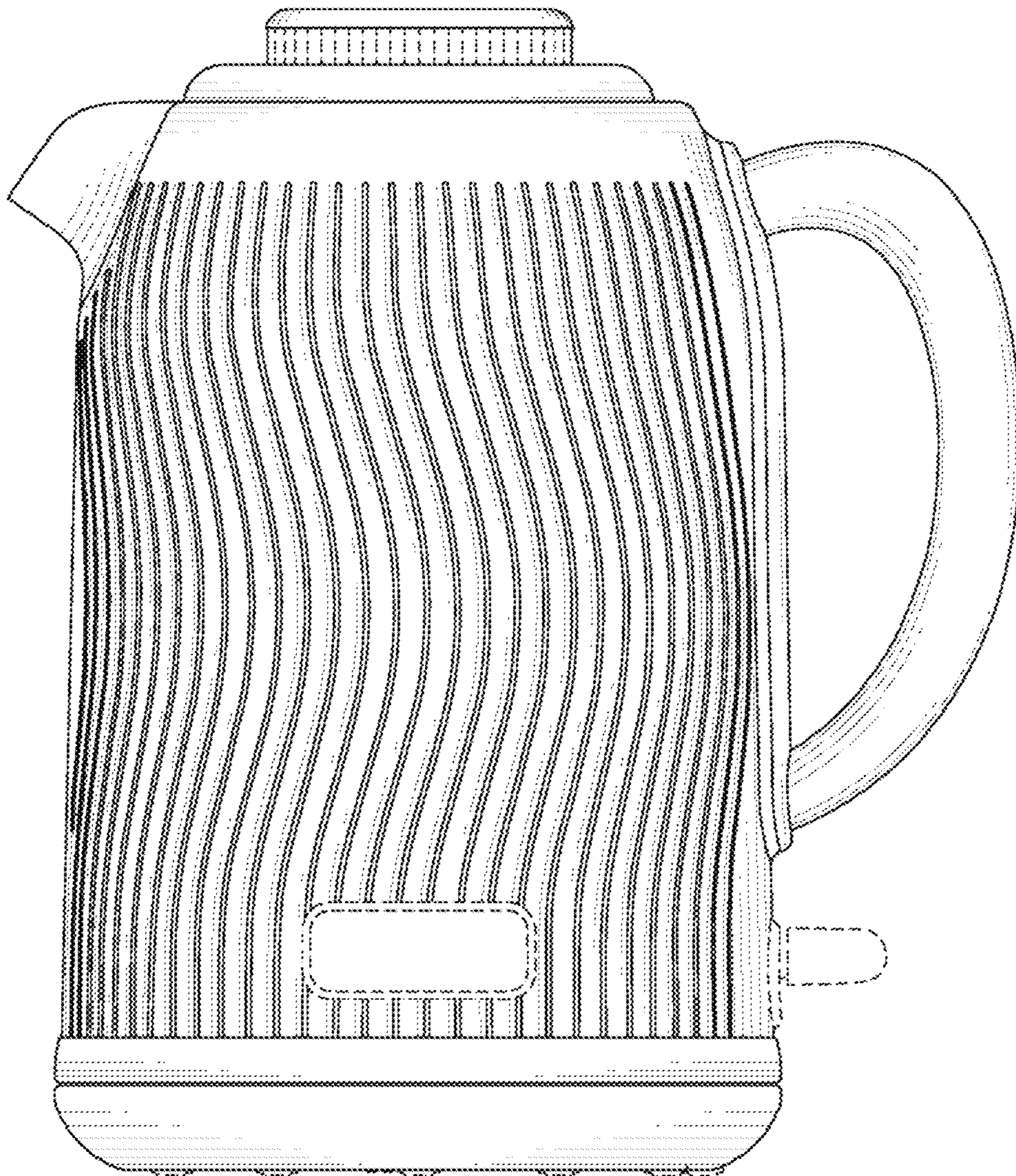

FIG. 7

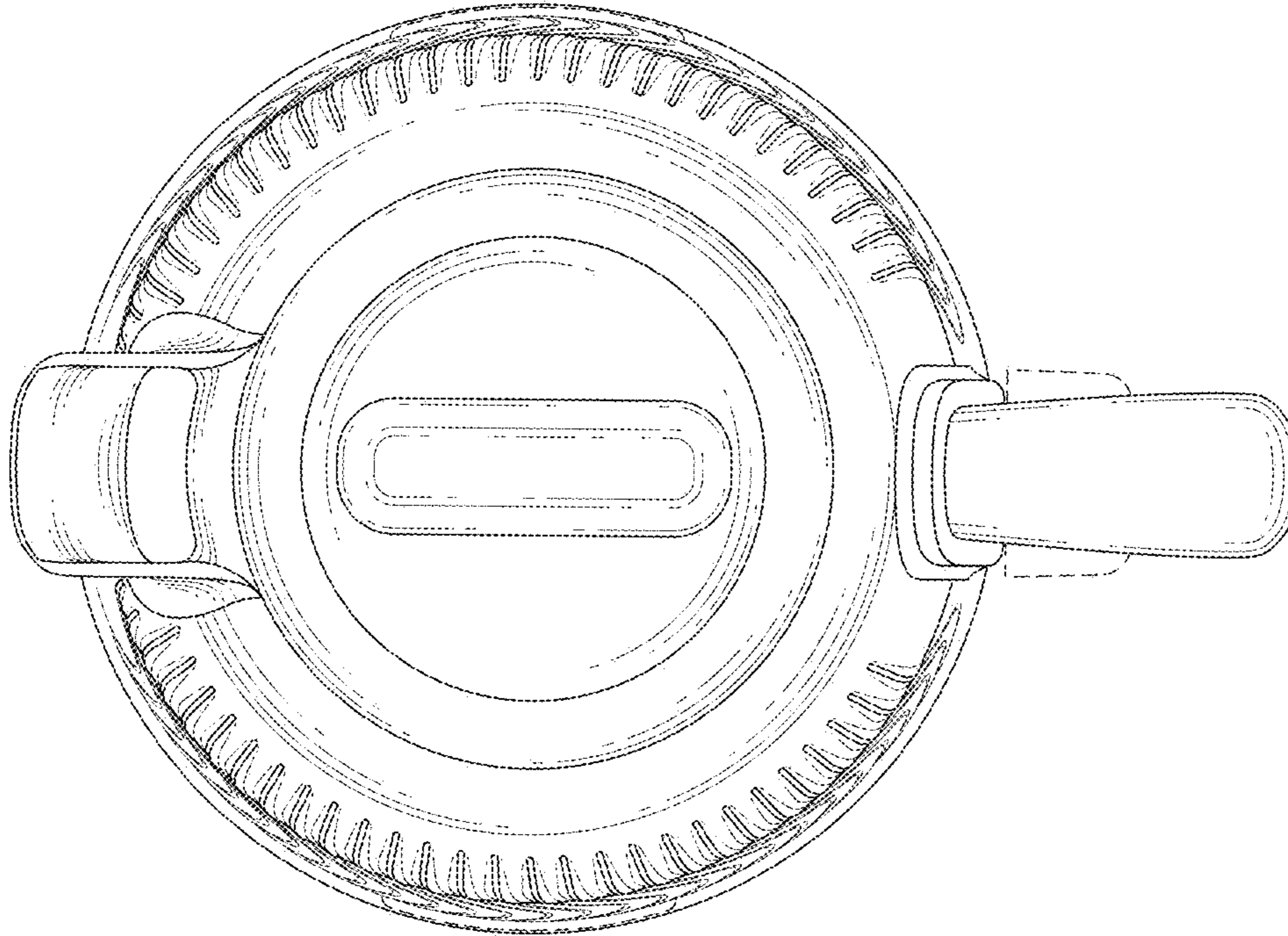

FIG. 8

