



US00D899170S

(12) **United States Design Patent** (10) **Patent No.:** **US D899,170 S**  
**Xue** (45) **Date of Patent:** **\*\* Oct. 20, 2020**

(54) **INTEGRATED MIXING CUP**

D779,882 S \* 2/2017 Plott ..... D7/511  
D789,737 S \* 6/2017 Eyal ..... D7/396.2  
9,706,880 B1 \* 7/2017 Kalamaras ..... A47J 43/27

(Continued)

(71) Applicant: **MAPLE LEAF TECHNOLOGY**  
**(SHENZHEN) CO., LTD.**, Shenzhen  
(CN)

(72) Inventor: **Sige Xue**, Shenzhen (CN)

(73) Assignee: **MAPLE LEAF TECHNOLOGY**  
**(SHENZHEN) CO., LTD.**, Shenzhen  
(CN)

(\*\*) Term: **15 Years**

(21) Appl. No.: **29/739,646**

(22) Filed: **Jun. 28, 2020**

(51) **LOC (12) Cl.** ..... **07-01**

(52) **U.S. Cl.**  
USPC ..... **D7/300.1; D7/511; D7/529; D7/531**

(58) **Field of Classification Search**  
USPC ..... D7/507, 509, 510, 511, 513, 529, 531,  
D7/532, 523, 533, 534, 535, 536, 392.1,  
D7/296.1, 396.2, 300.1, 608, 300, 320,  
D7/624.1, 624.2; D3/202; D9/501, 502,  
D9/503, 504, 530, 529, 522, 554, 567,  
D9/571, 569, 449, 516  
CPC ..... A47G 19/22; A47G 19/2288; A47G  
19/2205; A47G 19/2211; A47J 41/0077;  
A45F 3/16  
See application file for complete search history.

(56) **References Cited**

**U.S. PATENT DOCUMENTS**

D477,750 S \* 7/2003 Chuang ..... D7/518  
D658,064 S \* 4/2012 Barnes ..... D9/532  
D674,662 S \* 1/2013 Huang ..... D7/510  
D709,330 S \* 7/2014 Holmes ..... D7/529  
D730,694 S \* 6/2015 Elsaden ..... D7/511  
D747,148 S \* 1/2016 Beardsell ..... D7/511  
D757,496 S \* 5/2016 Julier ..... D7/510  
9,427,112 B2 \* 8/2016 Aliberti ..... B01F 15/00512  
D767,337 S \* 9/2016 Boroski ..... D7/510

**OTHER PUBLICATIONS**

[https://www.amazon.com/EQURA-Premium-Electric-Protein-Shaker/dp/B07X11S9B3/ref=sr\\_1\\_30?dchild=1&keywords=Electric%2BProtein%2BShaker%2BBottle&qid=1599683974&sr=8-30&th=1](https://www.amazon.com/EQURA-Premium-Electric-Protein-Shaker/dp/B07X11S9B3/ref=sr_1_30?dchild=1&keywords=Electric%2BProtein%2BShaker%2BBottle&qid=1599683974&sr=8-30&th=1) (Year: 2019).\*

(Continued)

*Primary Examiner* — Jae Liang

(57) **CLAIM**

The ornamental design for an integrated mixing cup, as shown and described.

**DESCRIPTION**

FIG. 1 is a perspective view of a first embodiment of an integrated mixing cup showing my new design; FIG. 2 is another perspective view thereof; FIG. 3 is a front elevational view thereof; FIG. 4 is a rear elevational view thereof; FIG. 5 is a left side elevational view thereof; FIG. 6 is a right side elevational view thereof; FIG. 7 is a top plan view thereof; FIG. 8 is a bottom plan view thereof; FIG. 9 is a perspective view of a second embodiment of the integrated mixing cup showing my new design; FIG. 10 is another perspective view thereof; FIG. 11 is a front elevational view thereof; FIG. 12 is a rear elevational view thereof; FIG. 13 is a left side elevational view thereof; FIG. 14 is a right side elevational view thereof; FIG. 15 is a top plan view thereof; and, FIG. 16 is a bottom plan view thereof. The broken lines in the drawings depict portions of the integrated mixing cup that form no part of the claimed design.

**1 Claim, 16 Drawing Sheets**

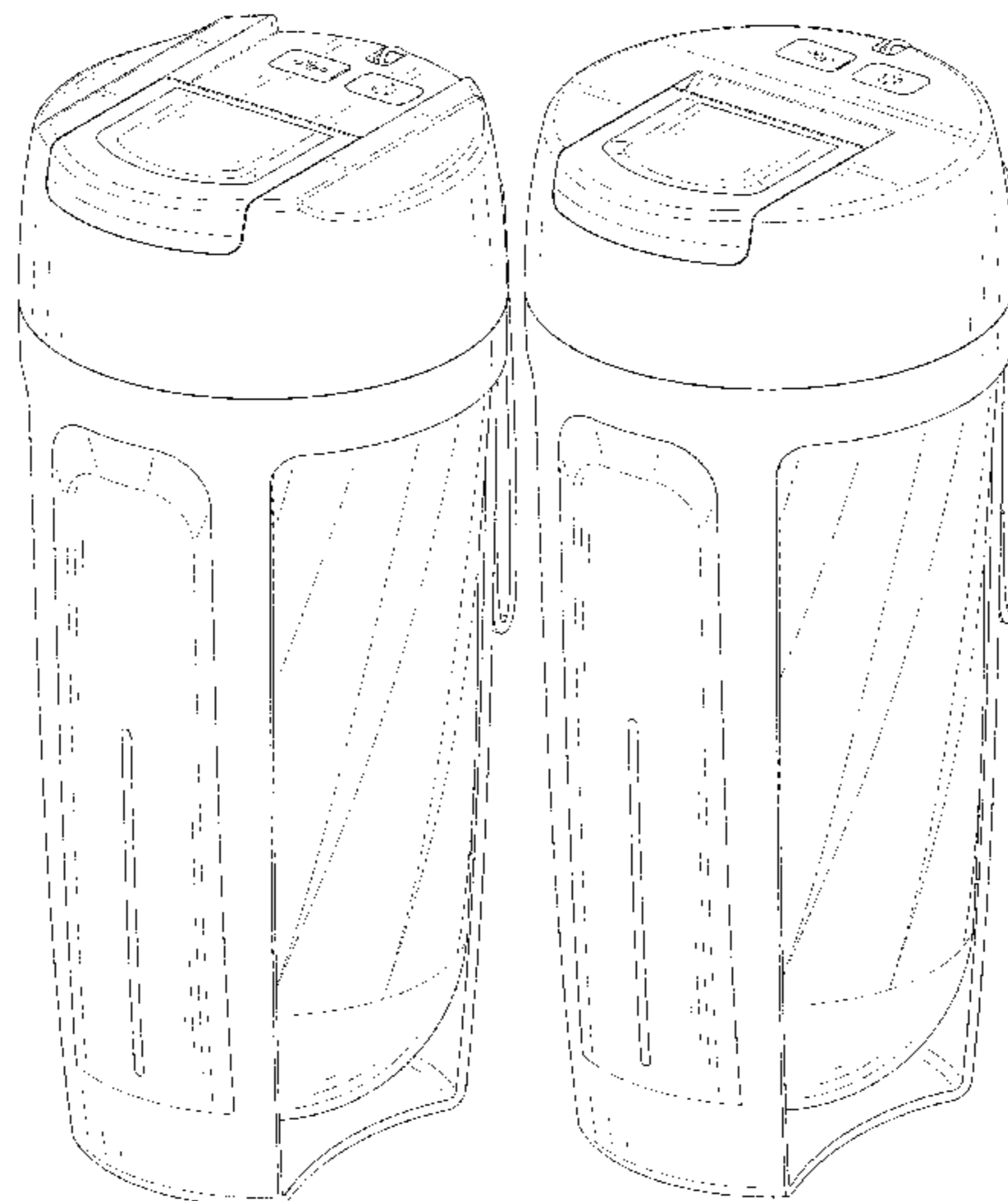

(56)

**References Cited**

U.S. PATENT DOCUMENTS

D811,814 S \* 3/2018 Plott ..... D7/396.6  
 D812,978 S 3/2018 Swan et al.  
 D836,985 S \* 1/2019 Otto ..... D7/510  
 D842,042 S \* 3/2019 Ke ..... D7/530  
 D843,784 S \* 3/2019 Black ..... D7/507  
 D854,378 S 7/2019 Breit et al.  
 D859,919 S \* 9/2019 Gronkowski ..... D7/510  
 10,524,598 B2 \* 1/2020 Green ..... A47G 19/2272  
 D878,842 S \* 3/2020 Wei ..... D7/300.1  
 D882,340 S \* 4/2020 Xue ..... D7/510  
 D883,034 S \* 5/2020 Abbasi ..... D7/529  
 D889,207 S \* 7/2020 Ambrosi ..... D7/529  
 2014/0192610 A1 \* 7/2014 Holmes ..... A47J 43/27  
 366/130  
 2014/0233344 A1 \* 8/2014 Aliberti ..... B01F 15/00512  
 366/130

OTHER PUBLICATIONS

[https://www.amazon.com/Portable-HK-RV-GEBLA089-N-30-Cordless-Personal-Stainless/dp/B07YD24KPD/ref=sr\\_1\\_5?dchild=1&keywords=portable+blender+for+juice&qid=1599686923&sr=8-5](https://www.amazon.com/Portable-HK-RV-GEBLA089-N-30-Cordless-Personal-Stainless/dp/B07YD24KPD/ref=sr_1_5?dchild=1&keywords=portable+blender+for+juice&qid=1599686923&sr=8-5) (Year: 2019).\*  
[https://www.amazon.com/ShakeSphere-Tumbler-VIEW-Blending-Smoothies/dp/B083V6SYH9/ref=pd\\_rhf\\_dp\\_p\\_img\\_1?encoding=UTF8&psc=1&refRID=80N5ZP7006Y8ECAC81EQ](https://www.amazon.com/ShakeSphere-Tumbler-VIEW-Blending-Smoothies/dp/B083V6SYH9/ref=pd_rhf_dp_p_img_1?encoding=UTF8&psc=1&refRID=80N5ZP7006Y8ECAC81EQ) (Year: 2020).\*

\* cited by examiner

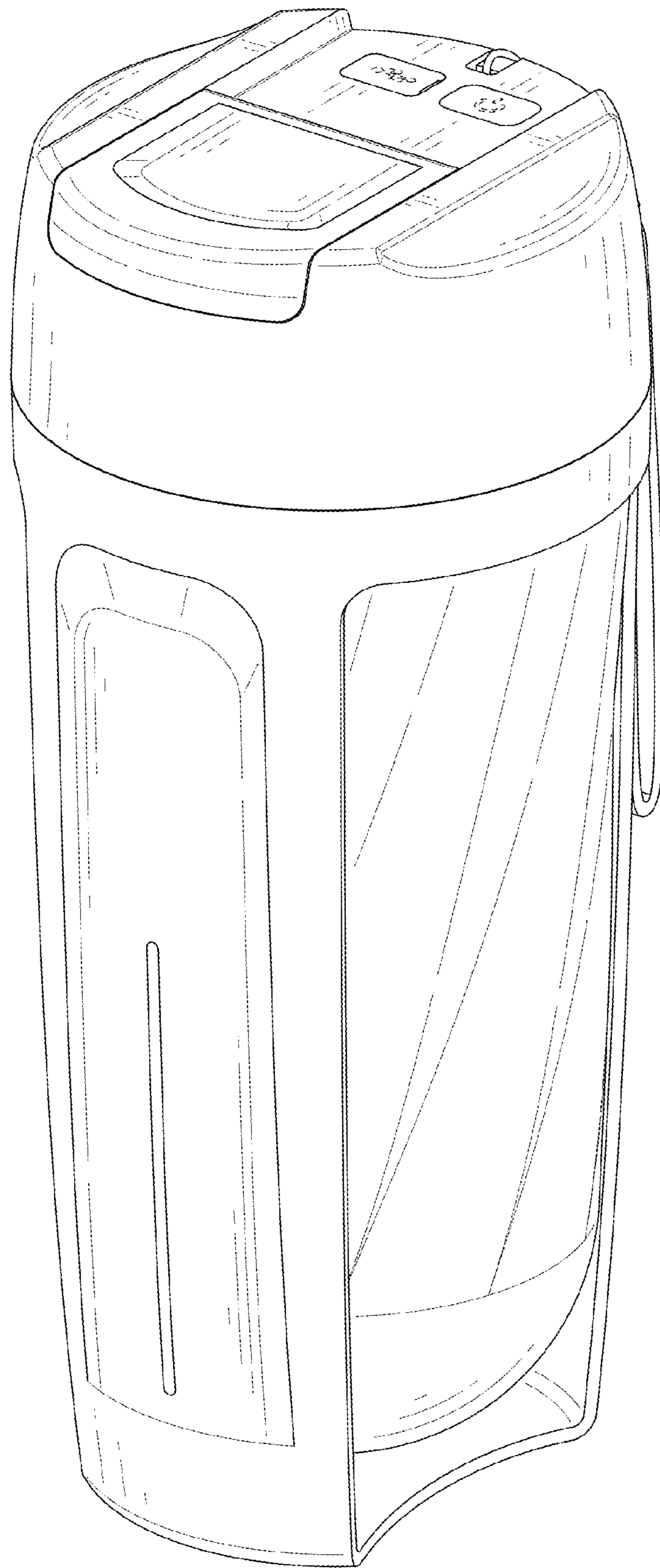

FIG. 1

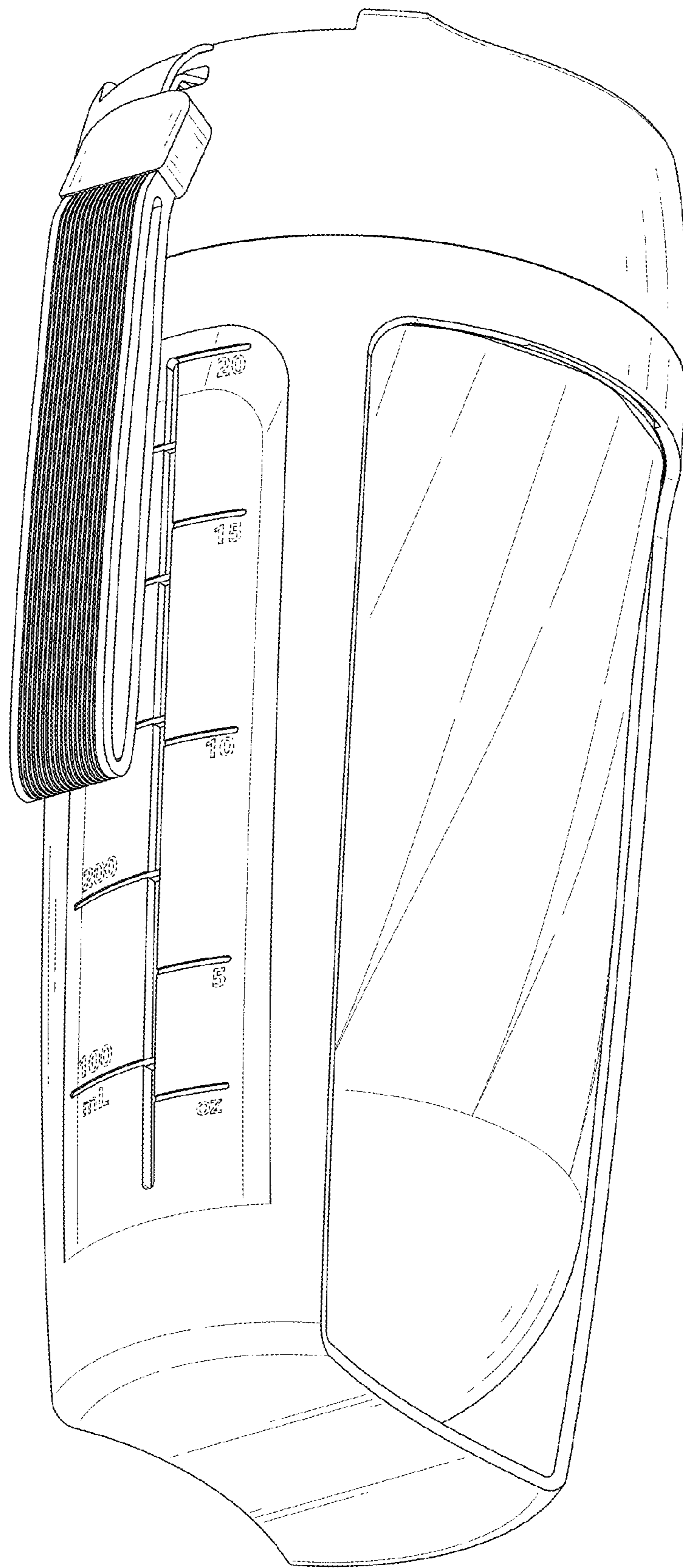

FIG. 2

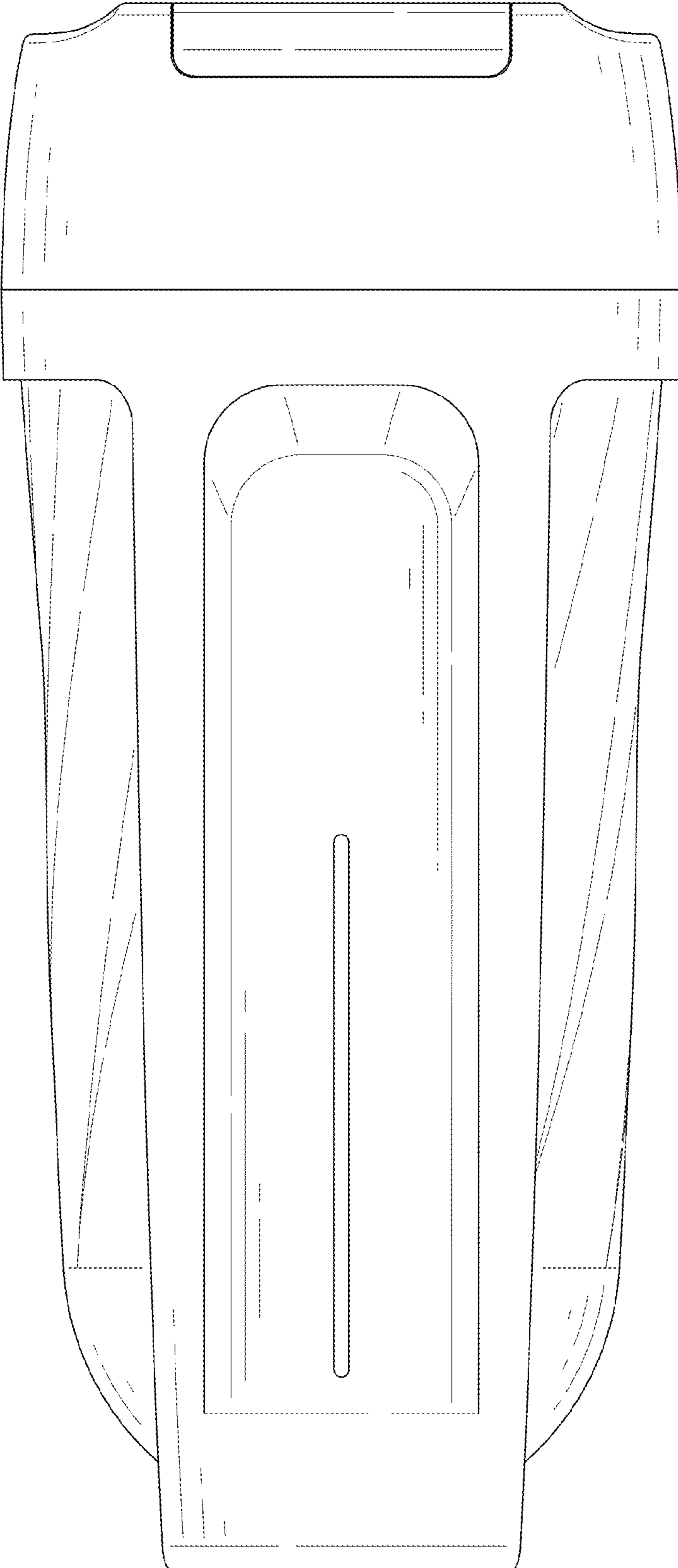

FIG. 3

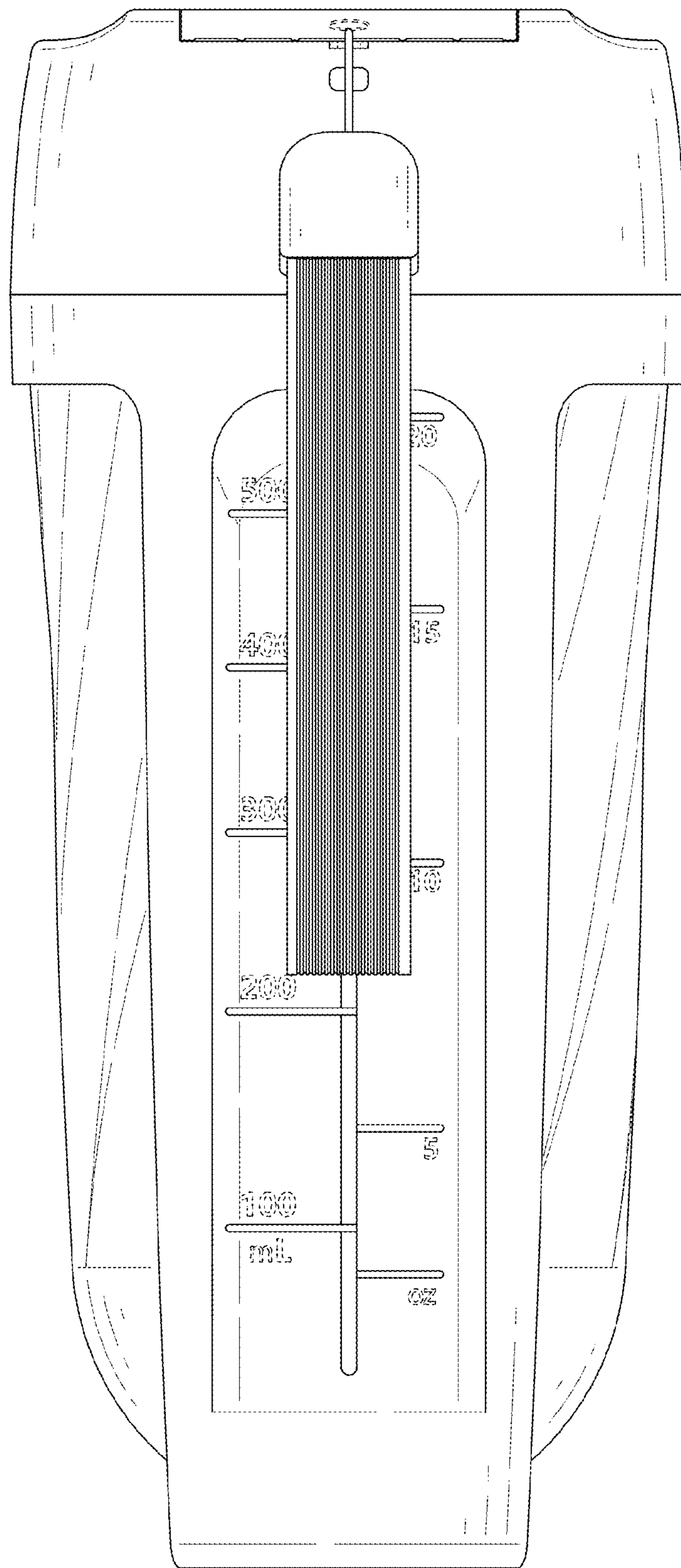

FIG. 4

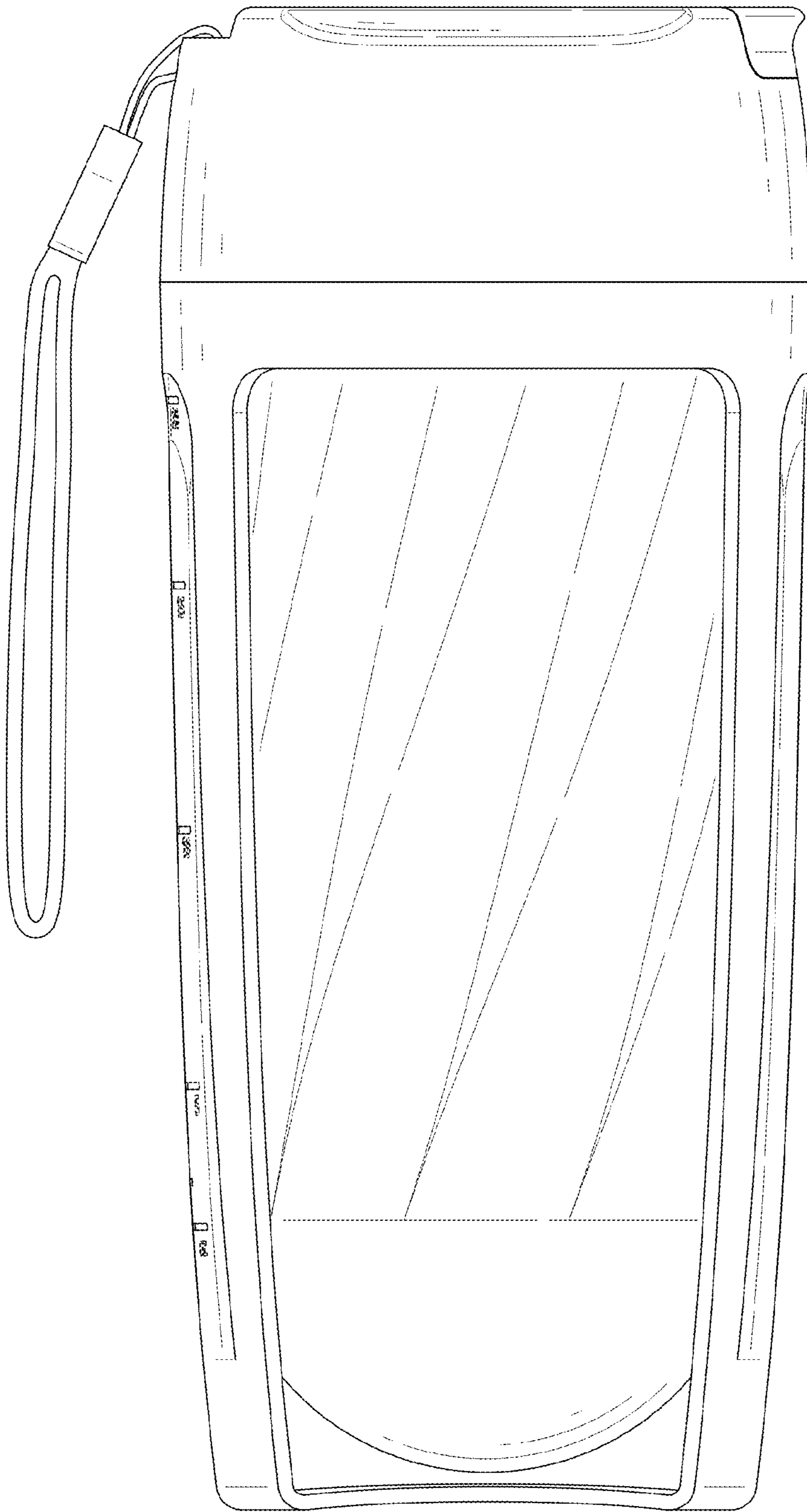

FIG. 5

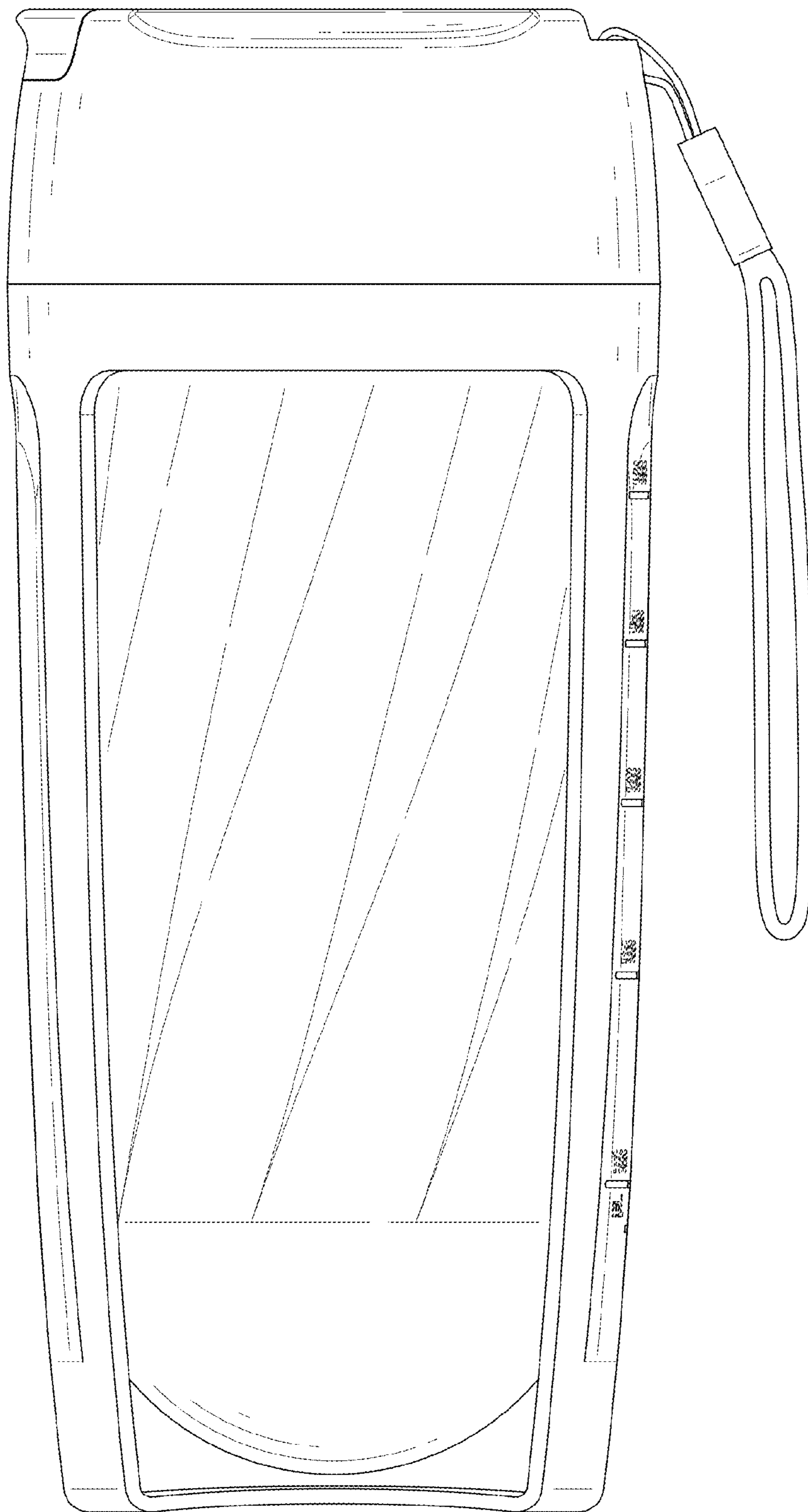

FIG. 6



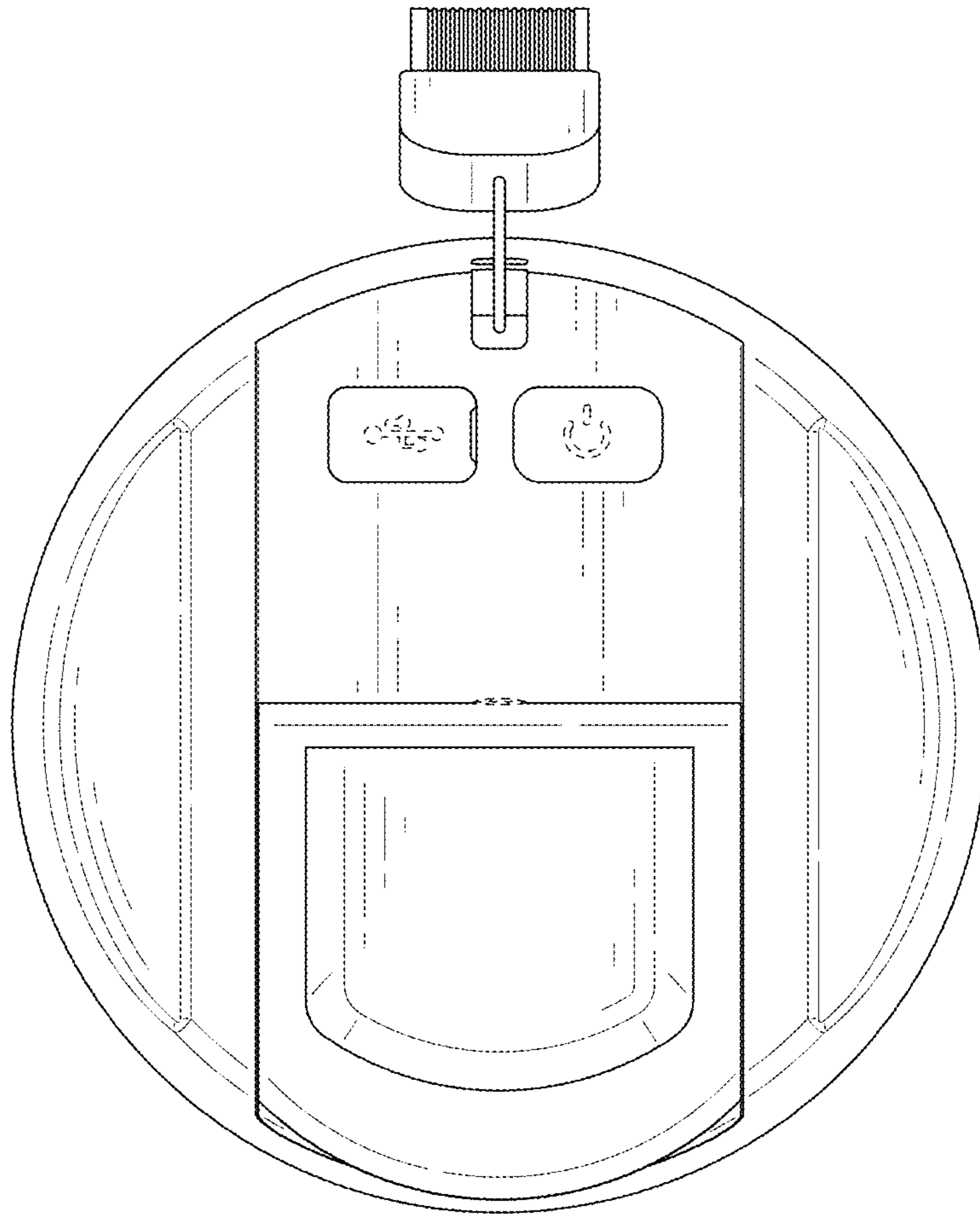

FIG. 7

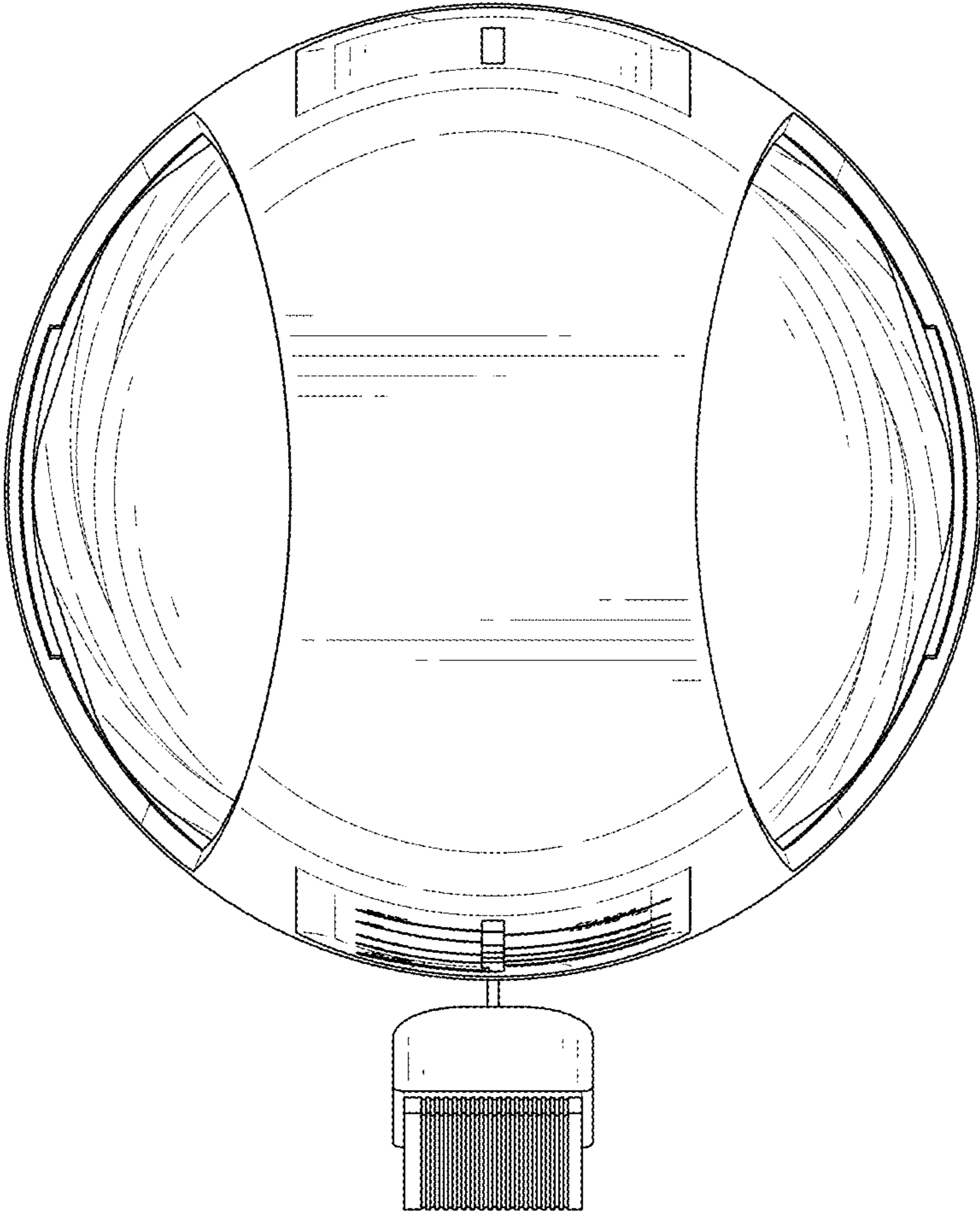

FIG. 8

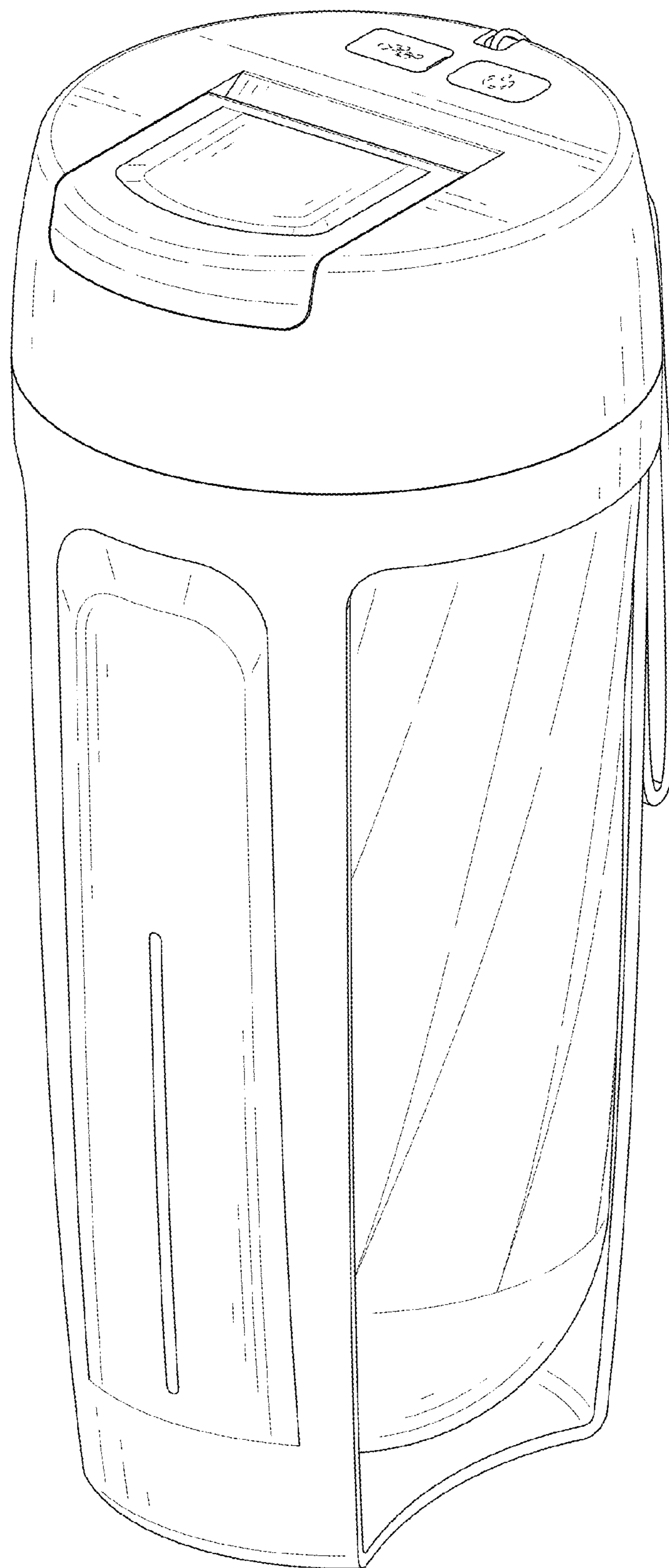

FIG. 9

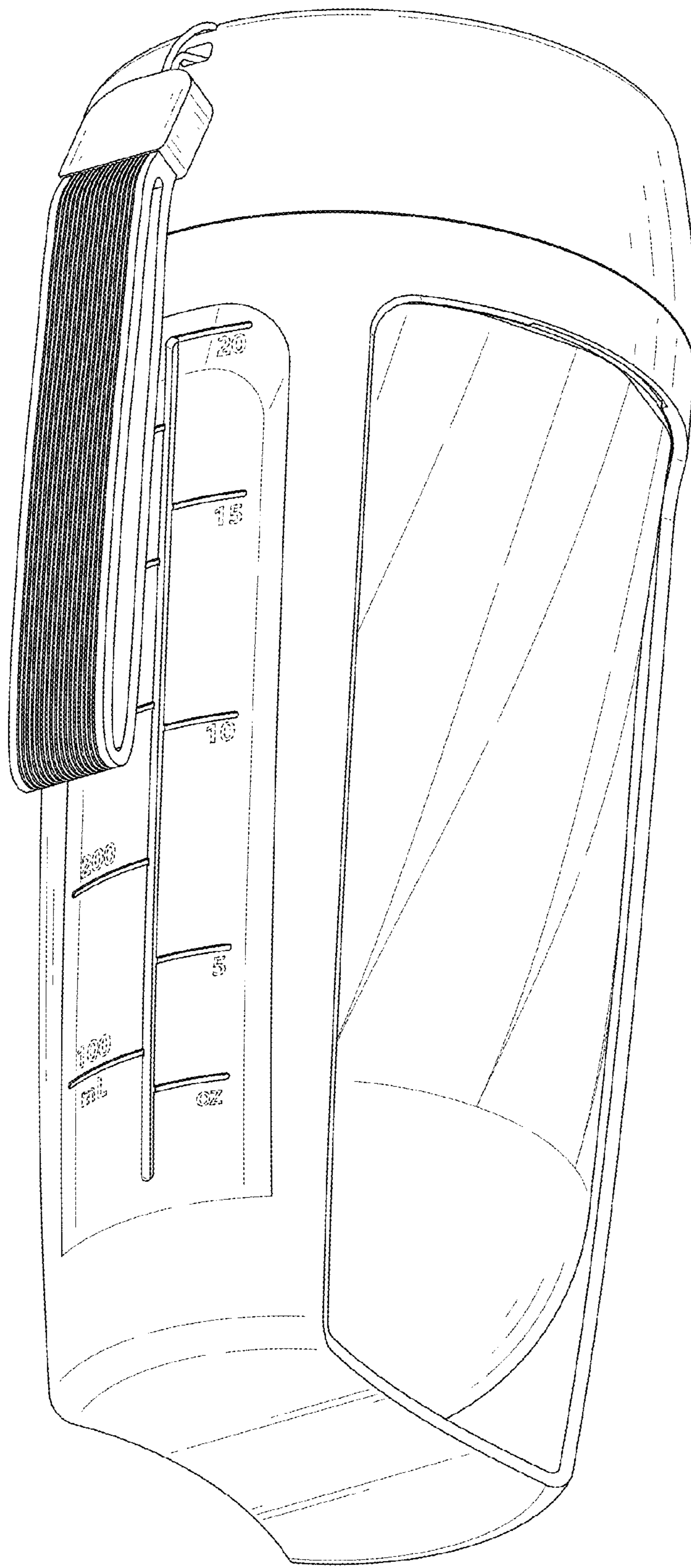

FIG. 10

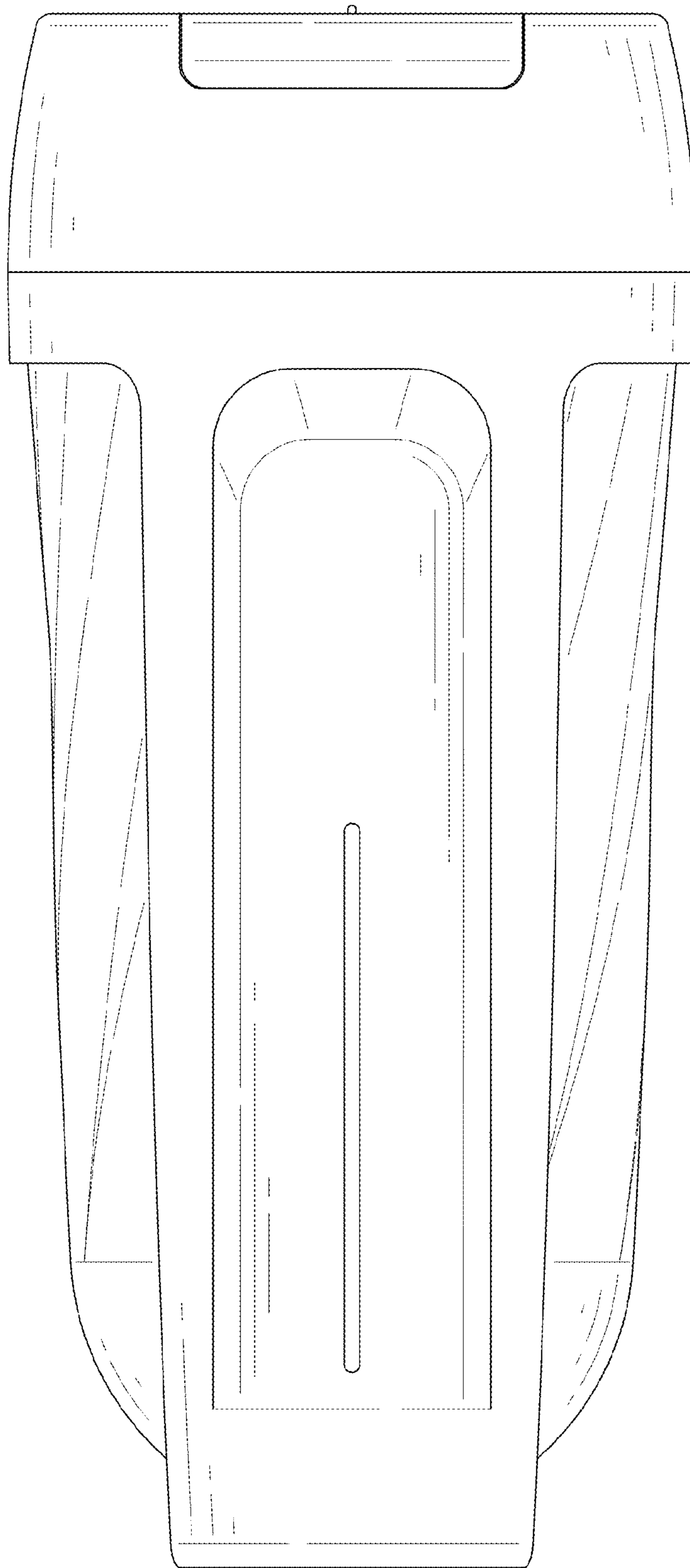

FIG. 11

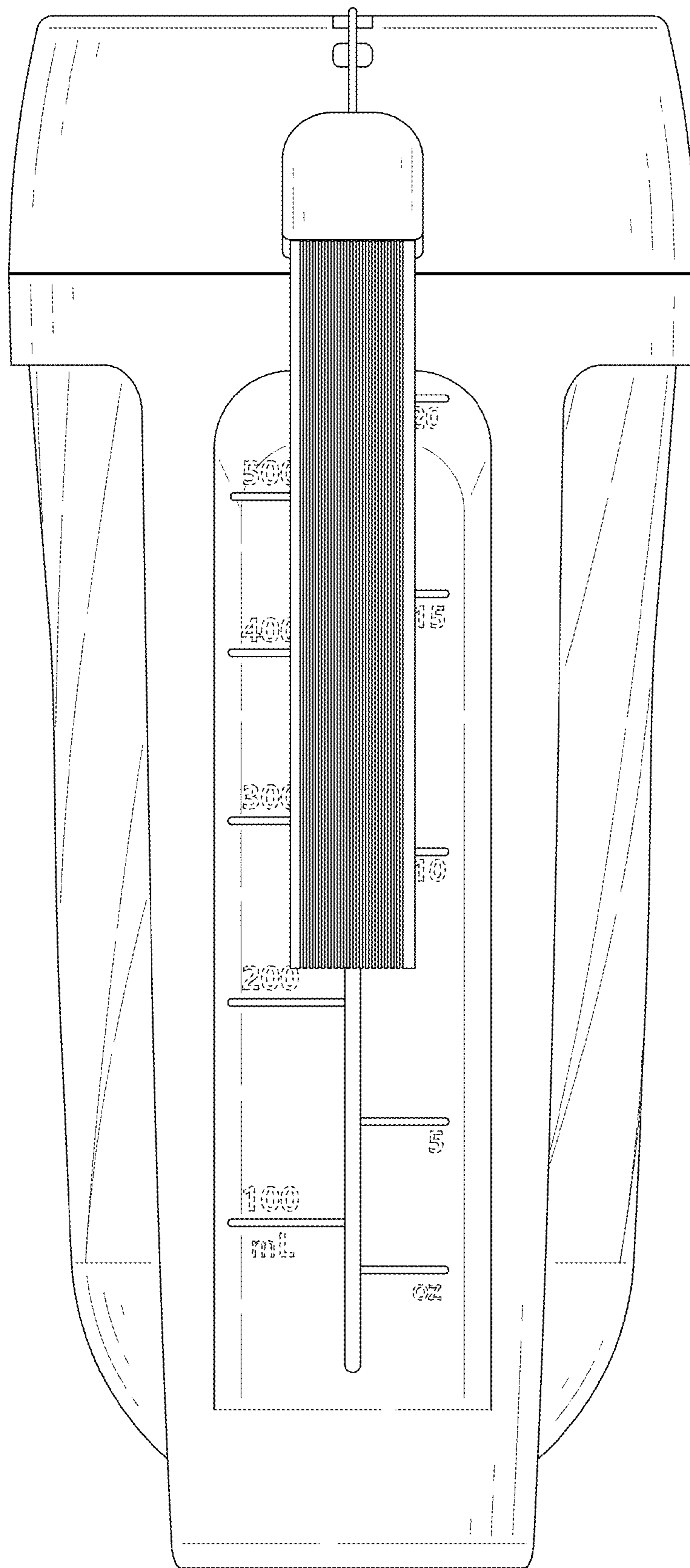

FIG. 12

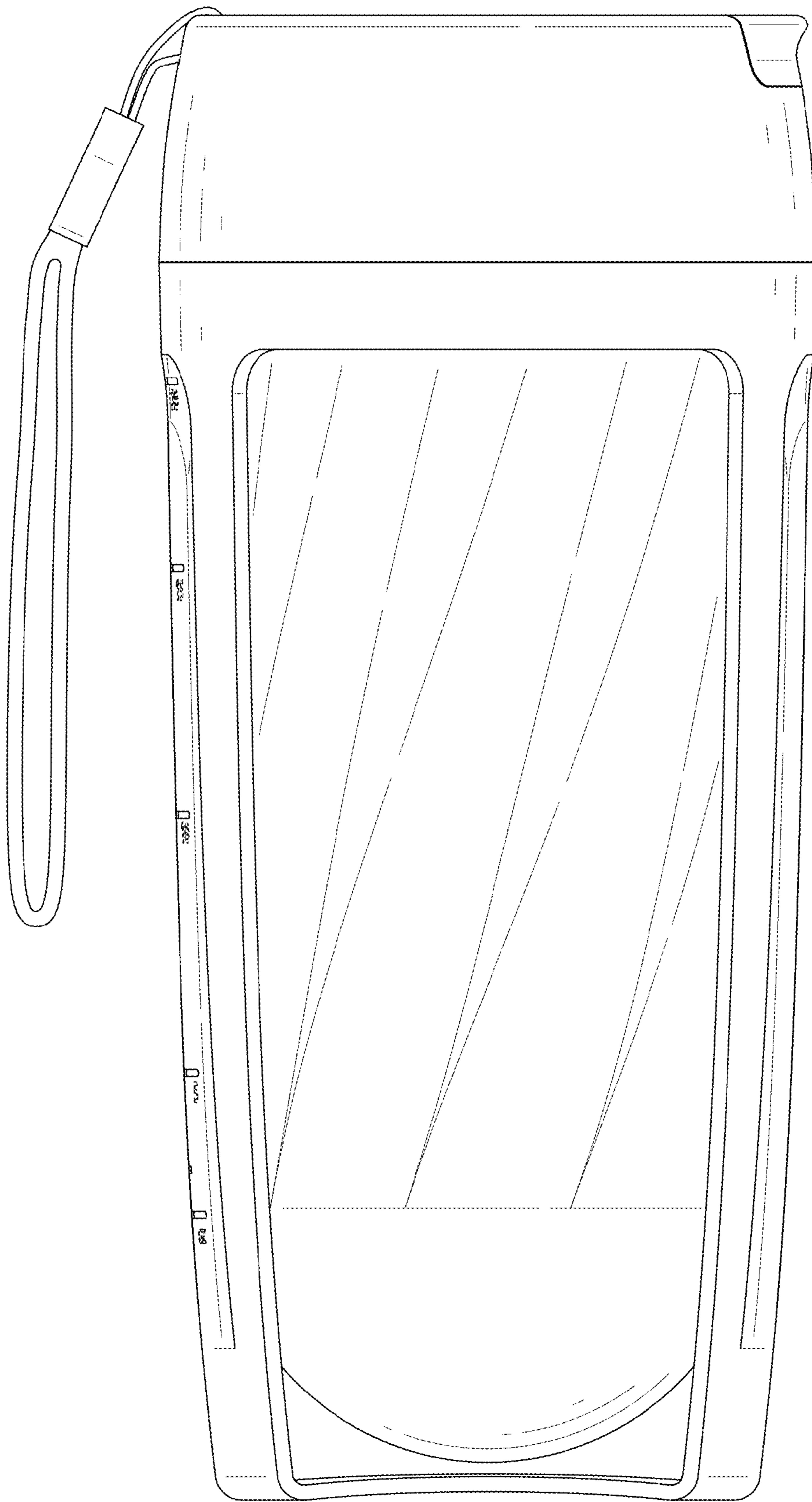

FIG. 13

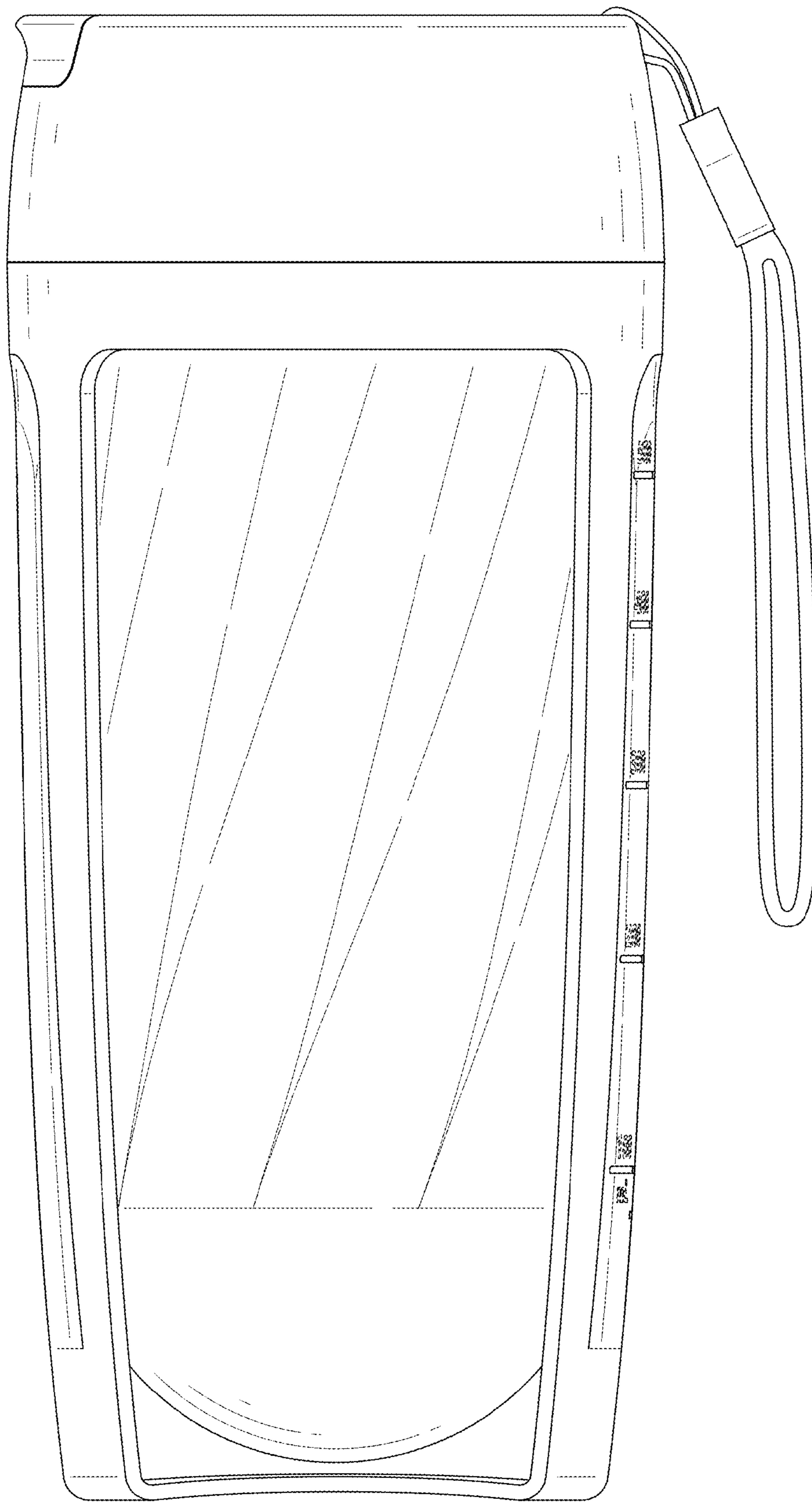

FIG. 14



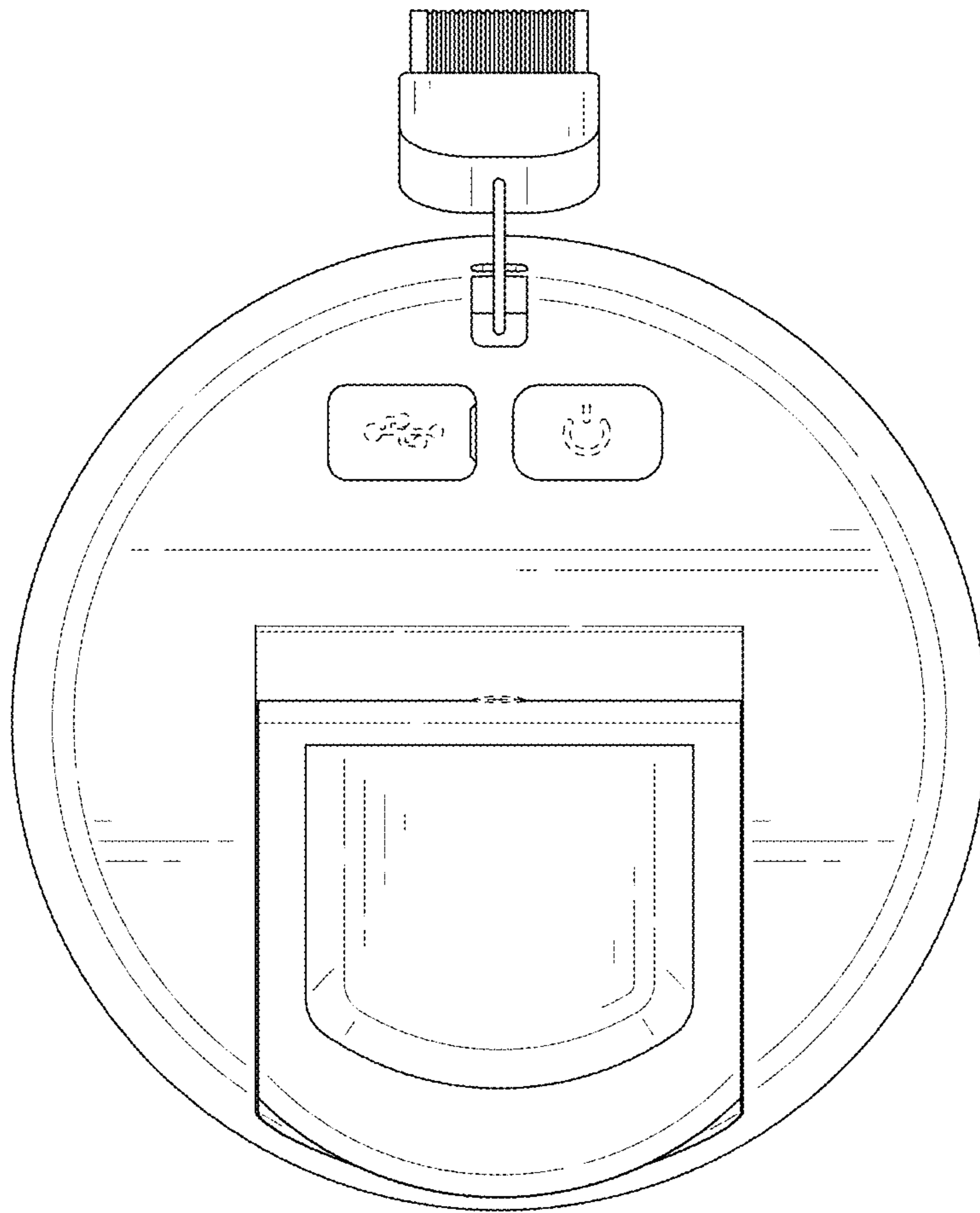

FIG. 15

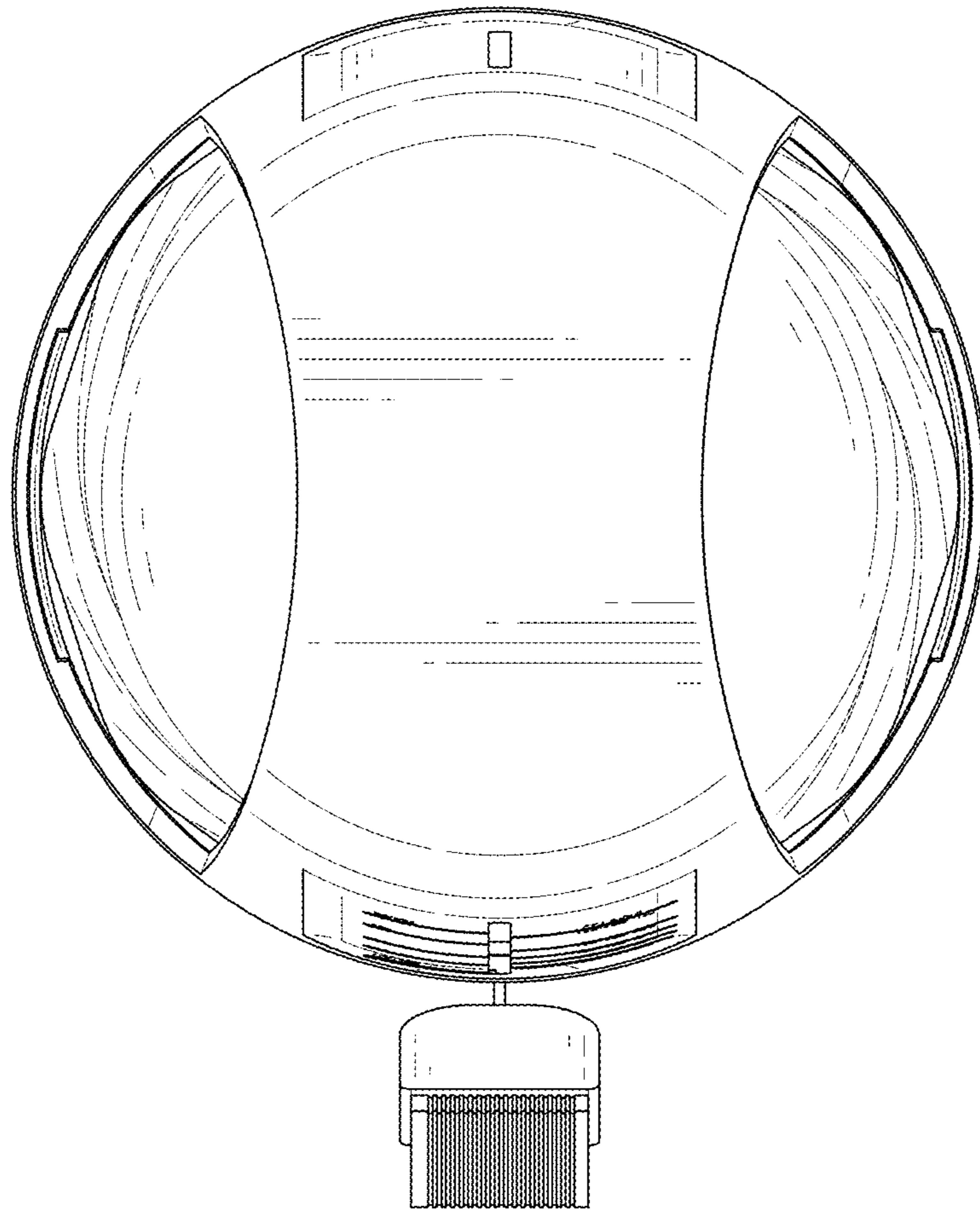

FIG. 16