



US00D899133S

(12) **United States Design Patent** (10) **Patent No.:** **US D899,133 S**
Frame et al. (45) **Date of Patent:** **** Oct. 20, 2020**

(54) **BATH DISPENSER**

(71) Applicants: **Cindi Frame**, Mill Valley, CA (US);
Jan McDougal, Mill Valley, CA (US);
Jack Pryne, Richmond, CA (US); **Joe Molinari**, San Rafael, CA (US)

(72) Inventors: **Cindi Frame**, Mill Valley, CA (US);
Jan McDougal, Mill Valley, CA (US);
Jack Pryne, Richmond, CA (US); **Joe Molinari**, San Rafael, CA (US)

(73) Assignee: **Kure LLC**, Mill Valley, CA (US)

(**) Term: **15 Years**

(21) Appl. No.: **29/671,910**

(22) Filed: **Nov. 30, 2018**

(51) **LOC (12) Cl.** **23-02**

(52) **U.S. Cl.**
USPC **D6/542**

(58) **Field of Classification Search**
USPC D6/542, 543-545; D9/682, 688, 690,
D9/291, 448, 449; 206/77.1; 221/96,
221/132; 222/92, 105, 173, 180, 181.1,
222/181.2, 181.3, 282, 283; 4/661
CPC B01L 3/52; B05B 11/3014; B05B 9/0403;
B05B 9/0426; C11D 17/08; A45D 19/02;
A47K 5/12; A47K 5/1202; A47K 5/1211;
B67D 7/0255; B01F 15/0243; B01F
15/0254; B01F 5/12; B01F 5/20
See application file for complete search history.

(56) **References Cited**

U.S. PATENT DOCUMENTS

D611,747 S *	3/2010	Kramer	D6/545
D639,591 S *	6/2011	Wallace	D6/545
D683,989 S *	6/2013	Jin	D6/545
D693,140 S *	11/2013	Rospierski	D6/545
D805,805 S *	12/2017	Siu	D6/545
D853,748 S *	7/2019	Zou	D6/542

* cited by examiner

Primary Examiner — Wan Laymon

Assistant Examiner — Mark Booker

(74) *Attorney, Agent, or Firm* — Steven A. Nielsen;
www.NielsenPatents.com

(57) **CLAIM**

The ornamental design for a bath dispenser, as shown and described.

DESCRIPTION

FIG. 1 is a top and side perspective view of a bath dispenser showing a new design;
FIG. 2 is a front view thereof;
FIG. 3 is a back view thereof;
FIG. 4 is a right side view thereof;
FIG. 5 is a left side view thereof;
FIG. 6 is a bottom view thereof; and,
FIG. 7 is a top view thereof.
The dashed lines in the drawings show environmental conditions only and form no part of the claimed design.

1 Claim, 4 Drawing Sheets

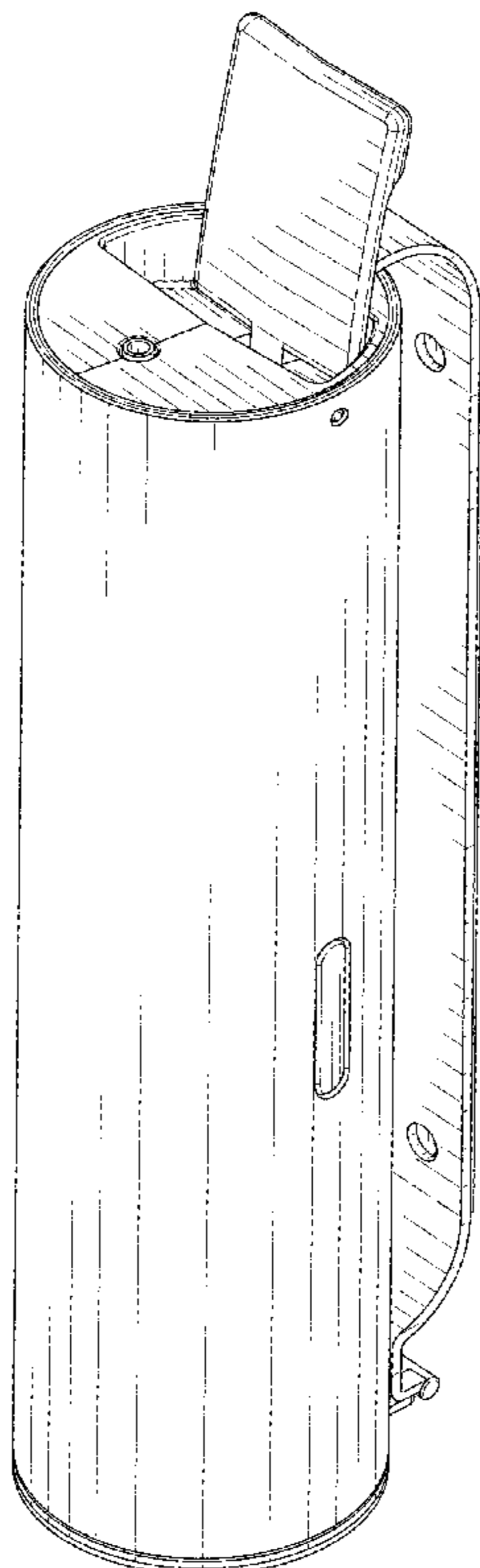

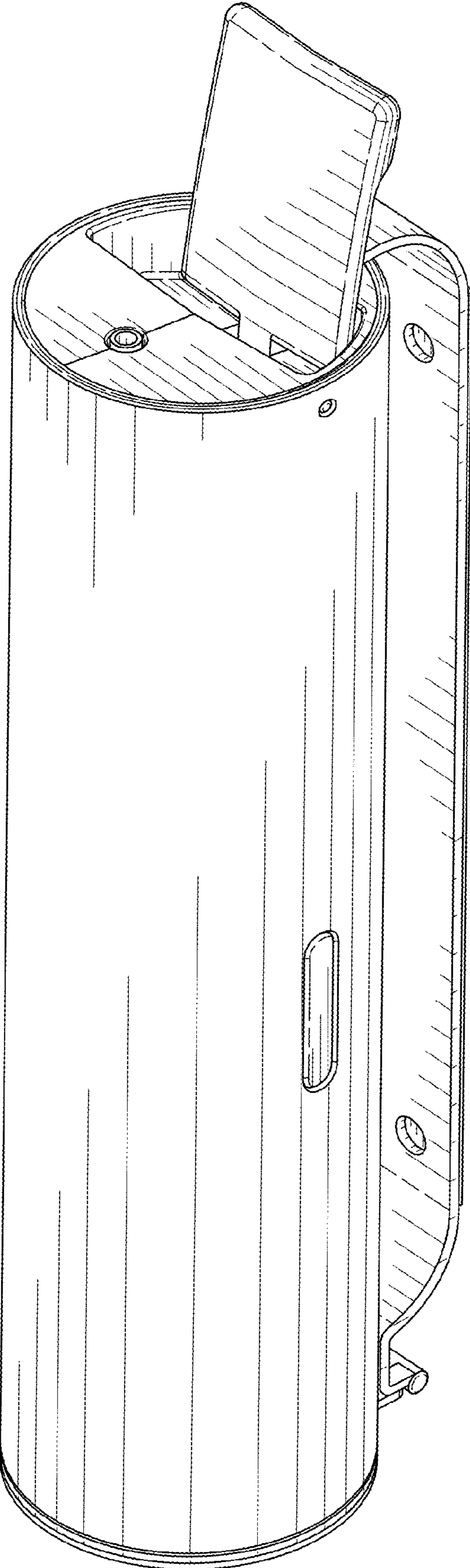

FIG. 1

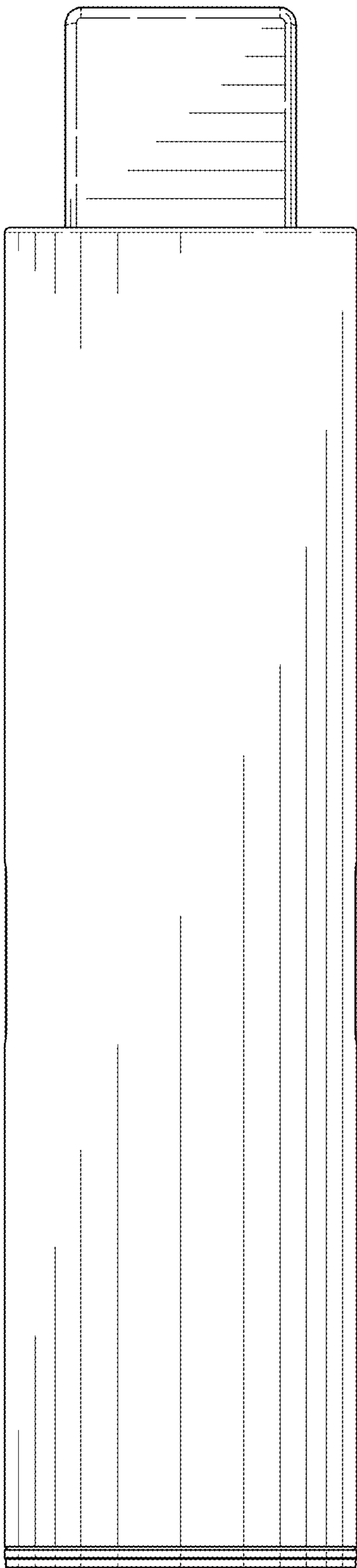

FIG. 2

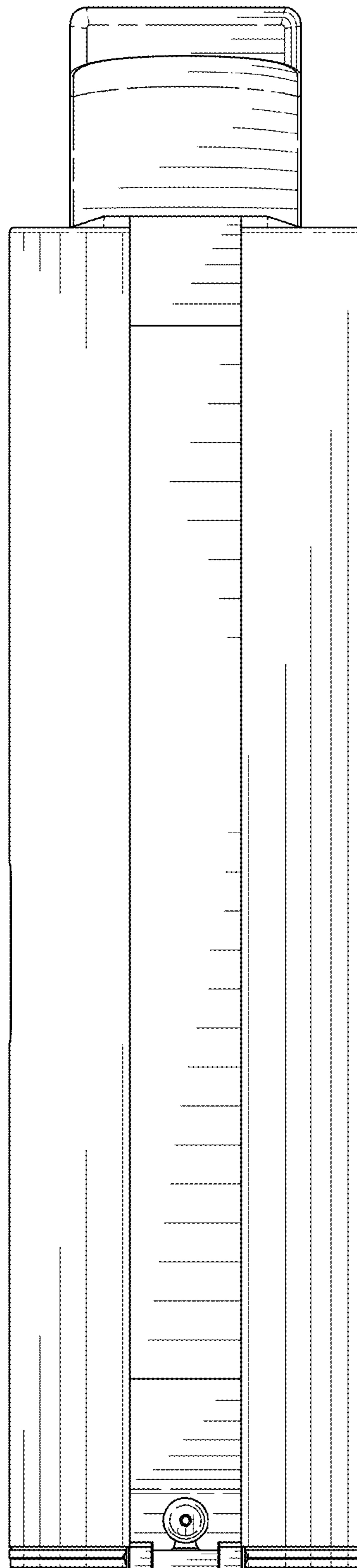

FIG. 3

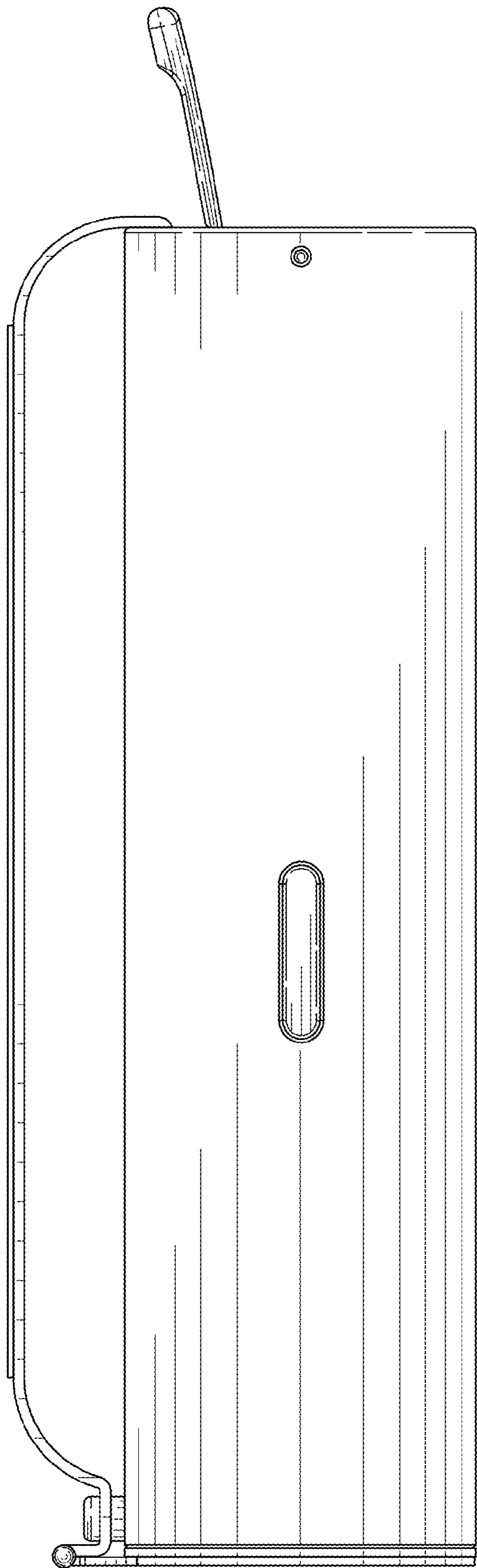

FIG. 4

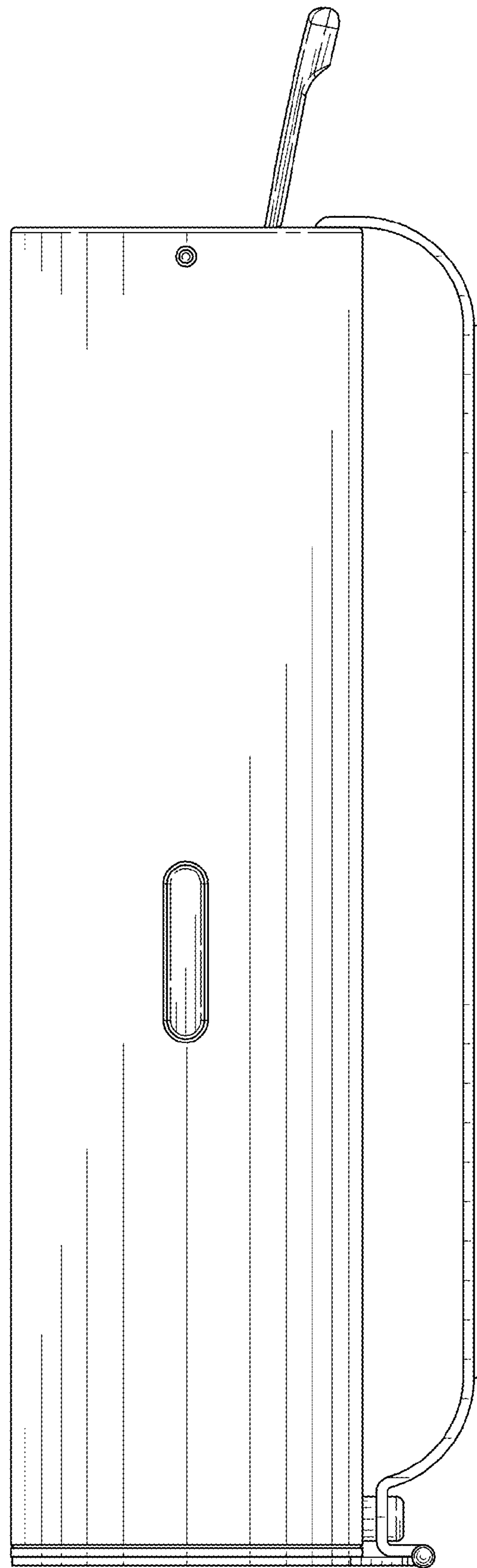

FIG. 5

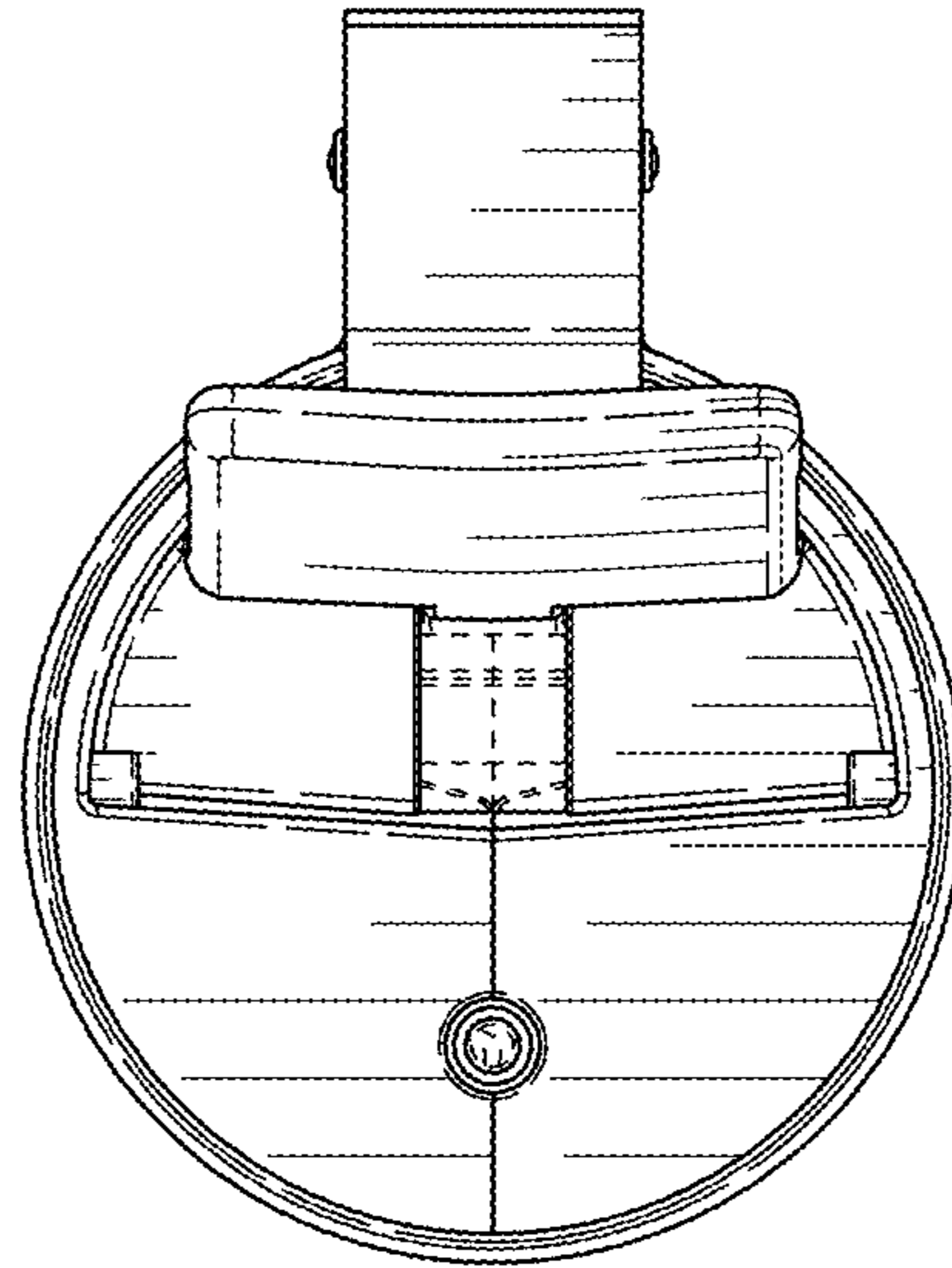

FIG. 6

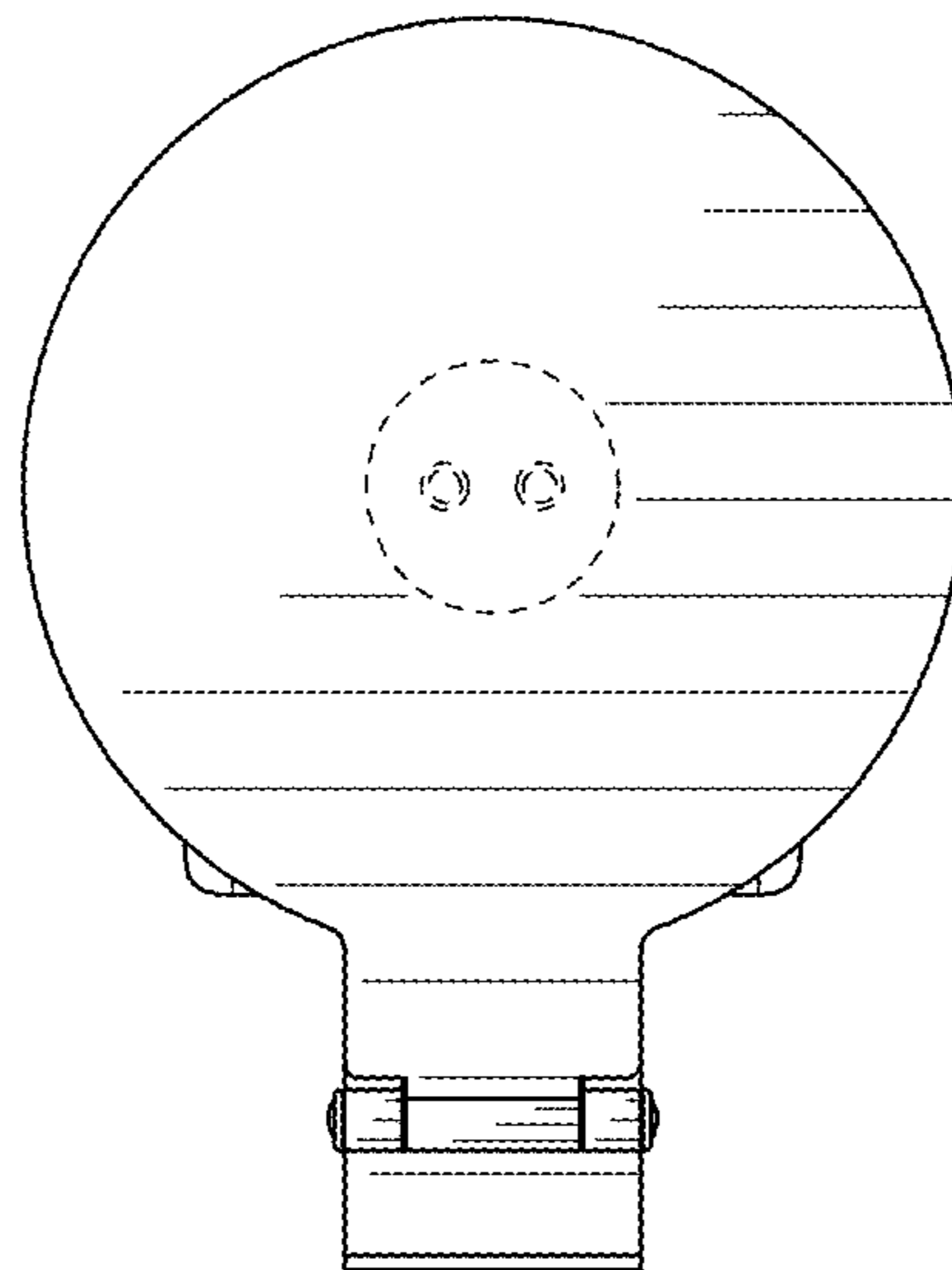

FIG. 7