



US00D898949S

(12) **United States Design Patent**  
**Helms et al.**

(10) **Patent No.:** **US D898,949 S**

(45) **Date of Patent:** **\*\* Oct. 13, 2020**

(54) **BUILDING EXTRUSION**

(71) Applicant: **Golden Homes Holdings Limited,**  
Tauranga (NZ)

(72) Inventors: **Lennard Trevor Helms,** Tauranga  
(NZ); **Michael Petersen,** Auckland  
(NZ)

(73) Assignee: **GOLDEN HOMES HOLDINGS**  
**LIMITED,** Tauranga (NZ)

(\*\*) Term: **15 Years**

(21) Appl. No.: **29/661,524**

(22) Filed: **Aug. 28, 2018**

(30) **Foreign Application Priority Data**

Feb. 28, 2018 (NZ) ..... 424128

(51) **LOC (12) Cl.** ..... **25-01**

(52) **U.S. Cl.**  
USPC ..... **D25/124**

(58) **Field of Classification Search**

USPC ..... D25/55, 60, 61, 119-125, 164, 199;  
D8/349, 354, 373

CPC ..... E04B 2/00; E04B 2/58; E04B 2/60; E04B  
2/72; E04B 2/721; E04B 2/723; E04B  
2/74; E04B 2002/725; E04B 2002/726;  
E04B 2002/728; E04B 2002/7461; E04B  
2002/7462; E04B 2002/7464; E04B  
2002/7487; E04B 1/00; E04B 1/18; E04B  
1/24; E04B 1/2403; E04B 1/38; E04B  
1/58; E04B 1/5806; E04B 2001/2466;  
E04B 2001/2481

See application file for complete search history.

(56) **References Cited**

**U.S. PATENT DOCUMENTS**

D210,286 S \* 2/1968 Venema ..... D25/122  
D210,287 S \* 2/1968 Venema ..... D25/122

D258,616 S \* 3/1981 Dallaire ..... D25/119  
5,201,159 A \* 4/1993 Goranson ..... E04B 2/72  
52/572  
D371,208 S \* 6/1996 De Zen ..... D25/122  
D402,049 S \* 12/1998 Goodchild ..... D25/122  
5,904,022 A \* 5/1999 Zadok ..... E04B 1/24  
52/650.1  
5,930,963 A \* 8/1999 Nichols ..... E04B 2/7422  
52/239  
D449,390 S \* 10/2001 Goss ..... D25/124  
D491,677 S \* 6/2004 Barnett ..... D25/119  
D527,114 S \* 8/2006 Hamill ..... D25/124  
D541,953 S \* 5/2007 Deleu ..... D25/122  
D547,462 S \* 7/2007 Petta ..... D25/122

(Continued)

*Primary Examiner* — Llorellys Martinez

(74) *Attorney, Agent, or Firm* — Knobbe, Martens, Olson  
& Bear, LLP

(57) **CLAIM**

The ornamental design for a building extrusion, as shown  
and described.

**DESCRIPTION**

FIG. 1 is a front end view of a building extrusion, showing  
our new design;  
FIG. 2 is a back end view thereof;  
FIG. 3 is a left side elevational view thereof;  
FIG. 4 is a right side elevational view thereof;  
FIG. 5 is a bottom plan view thereof;  
FIG. 6 is a top plan view thereof; and,  
FIG. 7 is a front, top and left side perspective view thereof.  
Broken lines are used in the drawings to illustrate features of  
the building extrusion that form no part of the claimed  
design. The building extrusion is shown with a symbolic  
break in its length. The appearance of any portion of the  
building extrusion between the break lines forms no part of  
the claimed design.

**1 Claim, 7 Drawing Sheets**

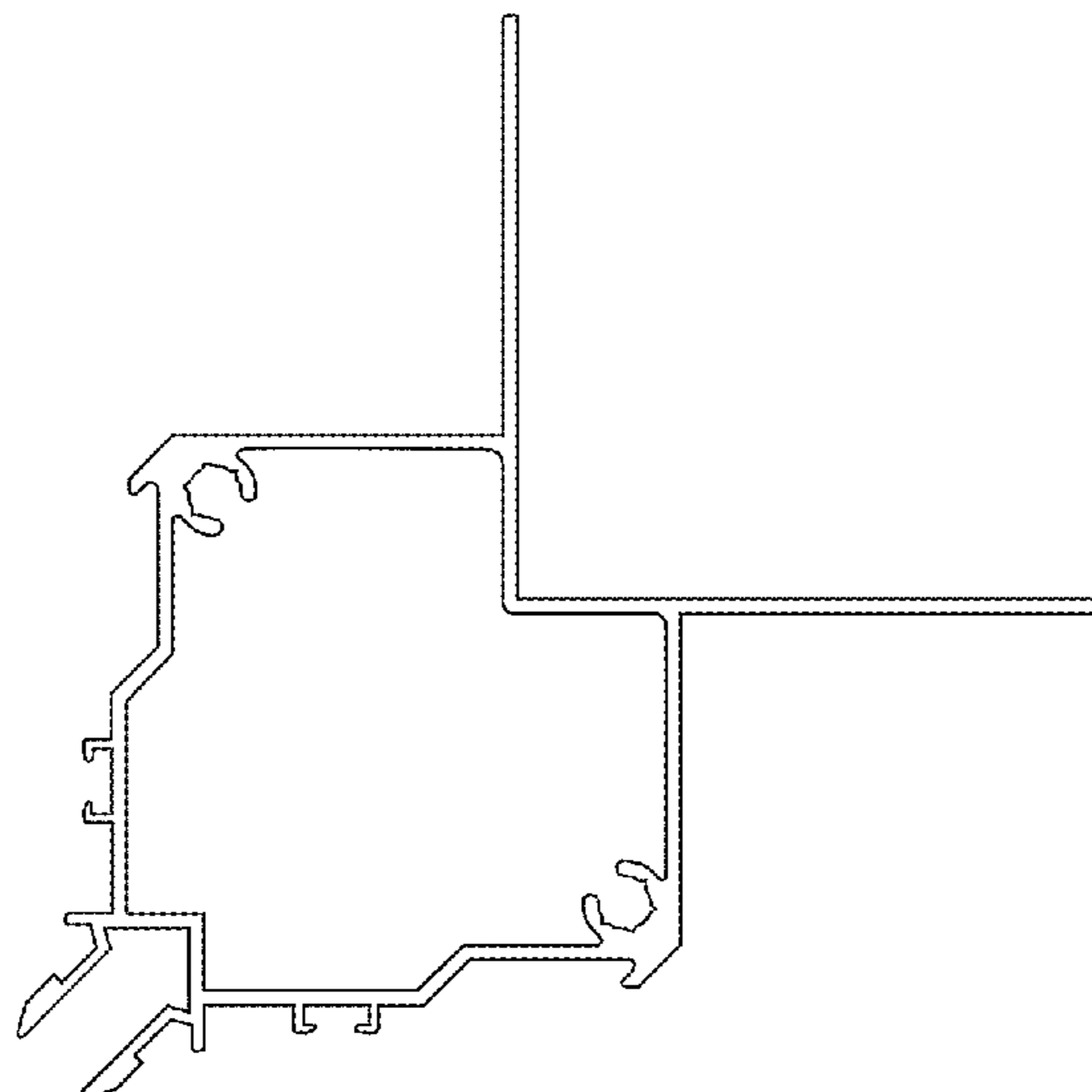

(56)

**References Cited**

U.S. PATENT DOCUMENTS

D550,862	S *	9/2007	Brabeck .....	D25/124
D561,353	S *	2/2008	Antonic .....	D25/122
D579,584	S *	10/2008	Chaney .....	D25/124
D582,570	S *	12/2008	Hull .....	D25/124
D690,436	S *	9/2013	Elizarraras .....	D25/136
D700,360	S *	2/2014	Elizarraras .....	D25/136
D814,059	S *	3/2018	Singh .....	D25/119
D829,348	S *	9/2018	Hynek .....	D25/119
D845,516	S *	4/2019	Yuan .....	D25/121
D851,787	S *	6/2019	Busl .....	D25/122
2007/0094992	A1 *	5/2007	Antonic .....	E04B 1/24 52/656.1
2007/0193143	A1 *	8/2007	Antonic .....	E06B 3/6621 52/241
2017/0138059	A1 *	5/2017	Omori .....	E04B 1/24

\* cited by examiner

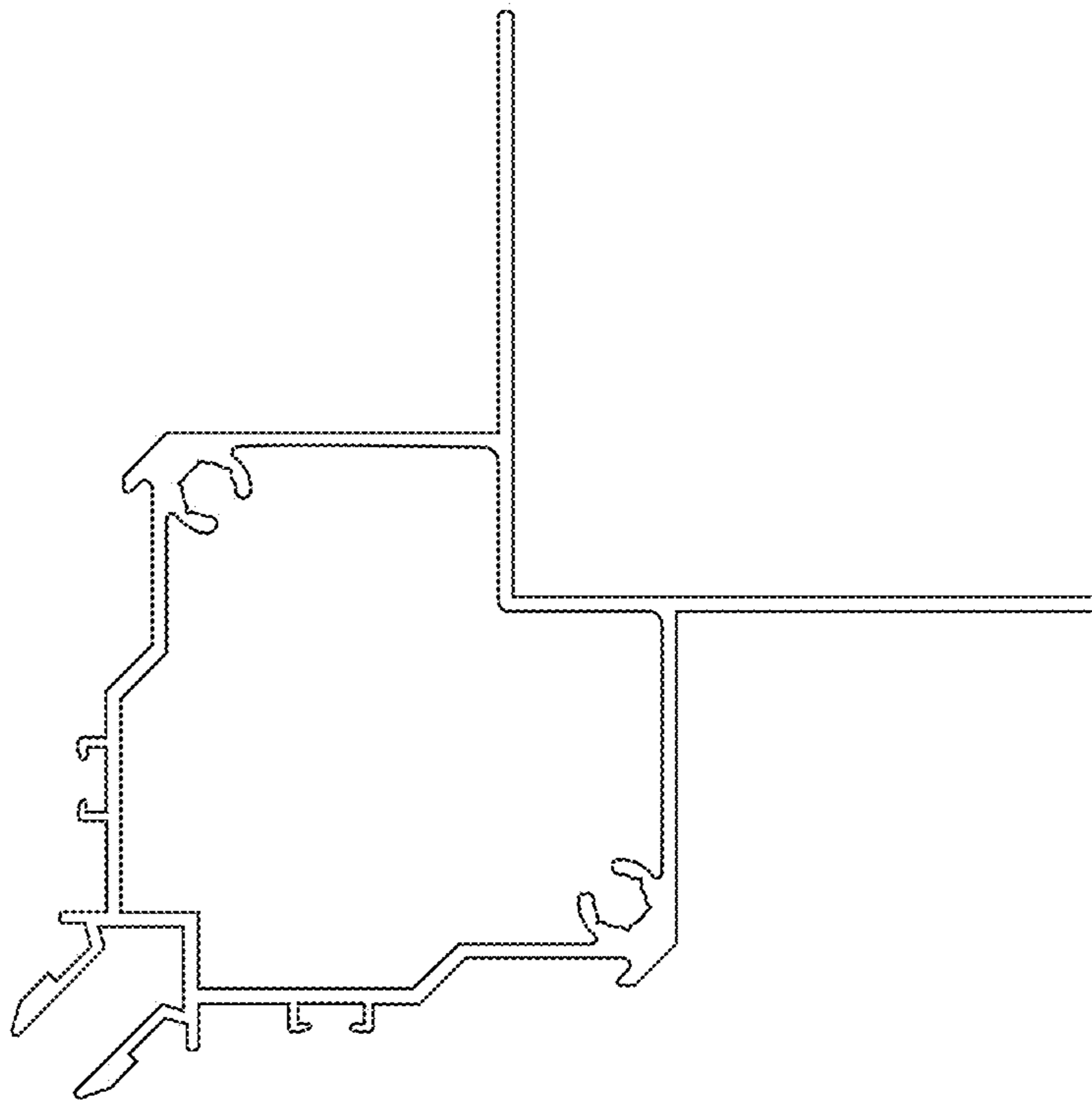

FIG. 1

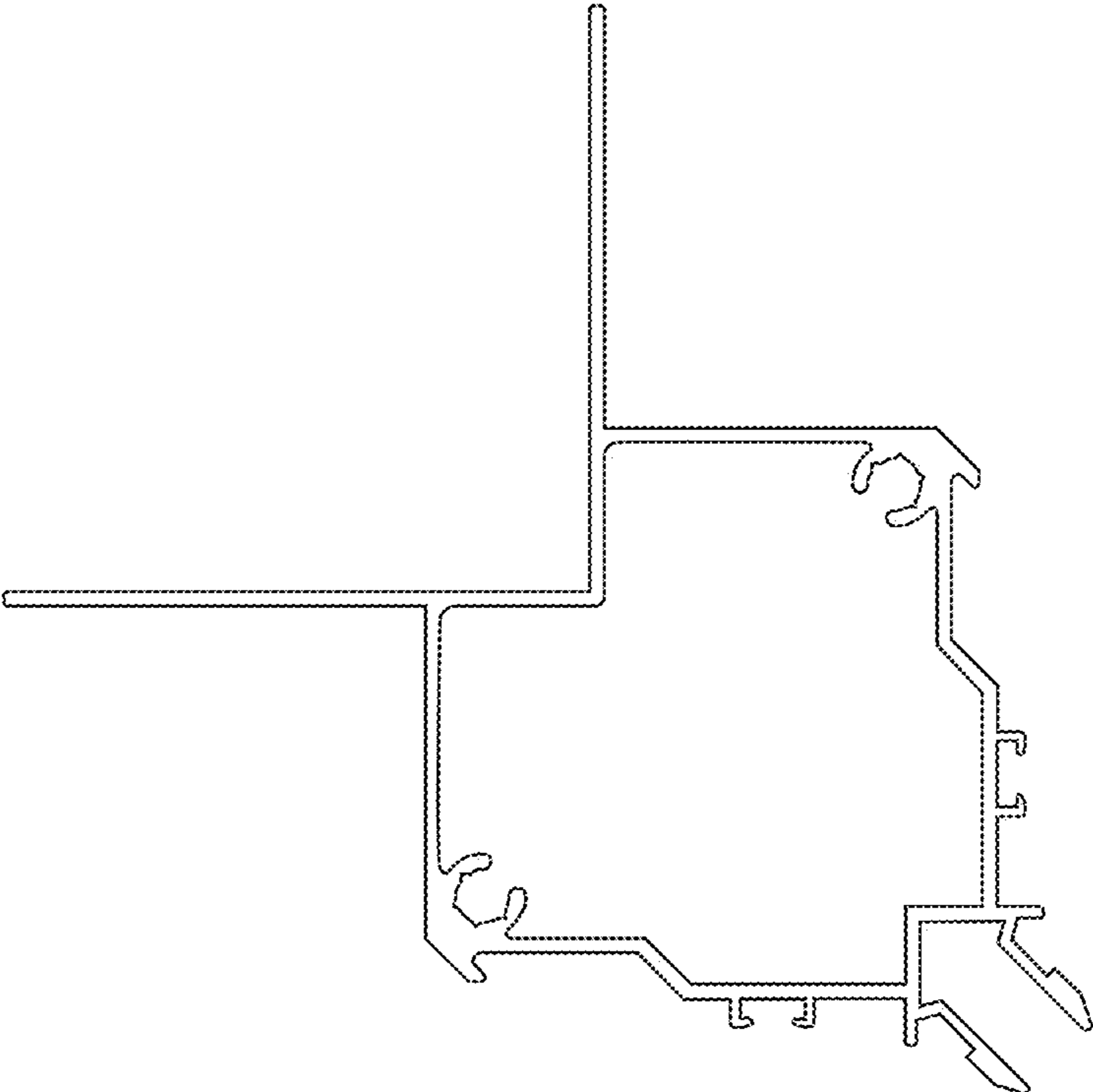

FIG. 2

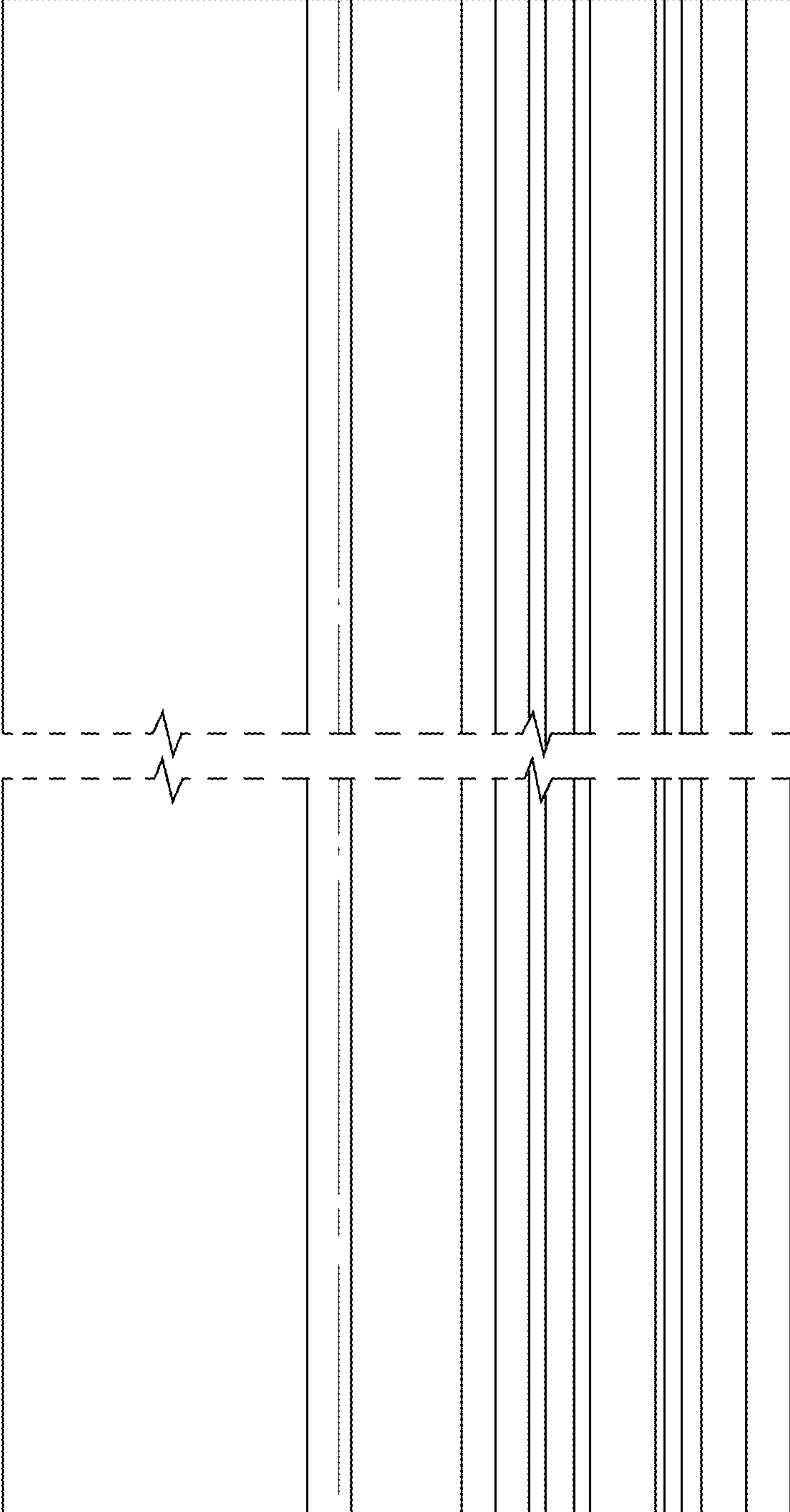

FIG. 3

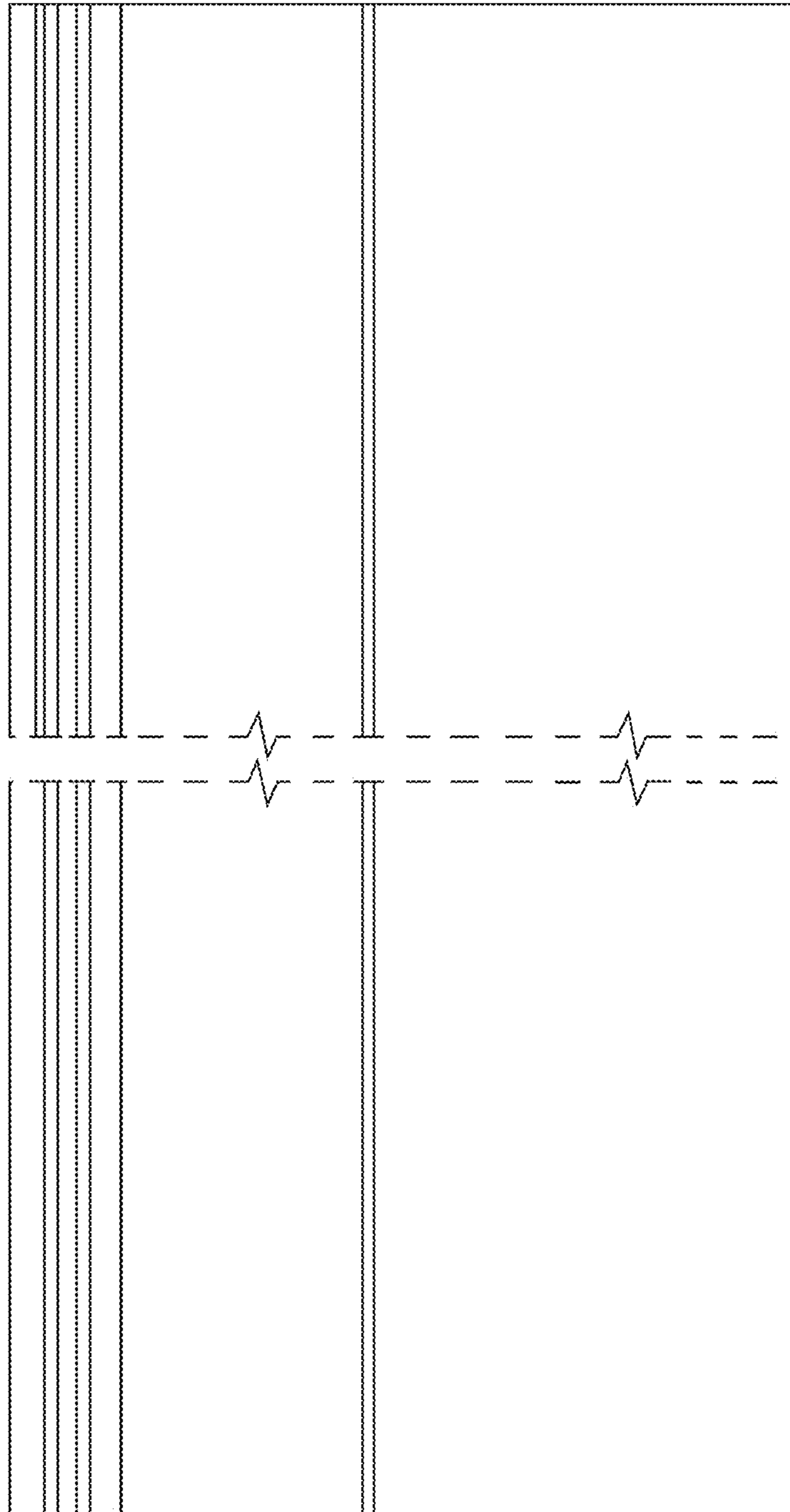

FIG. 4

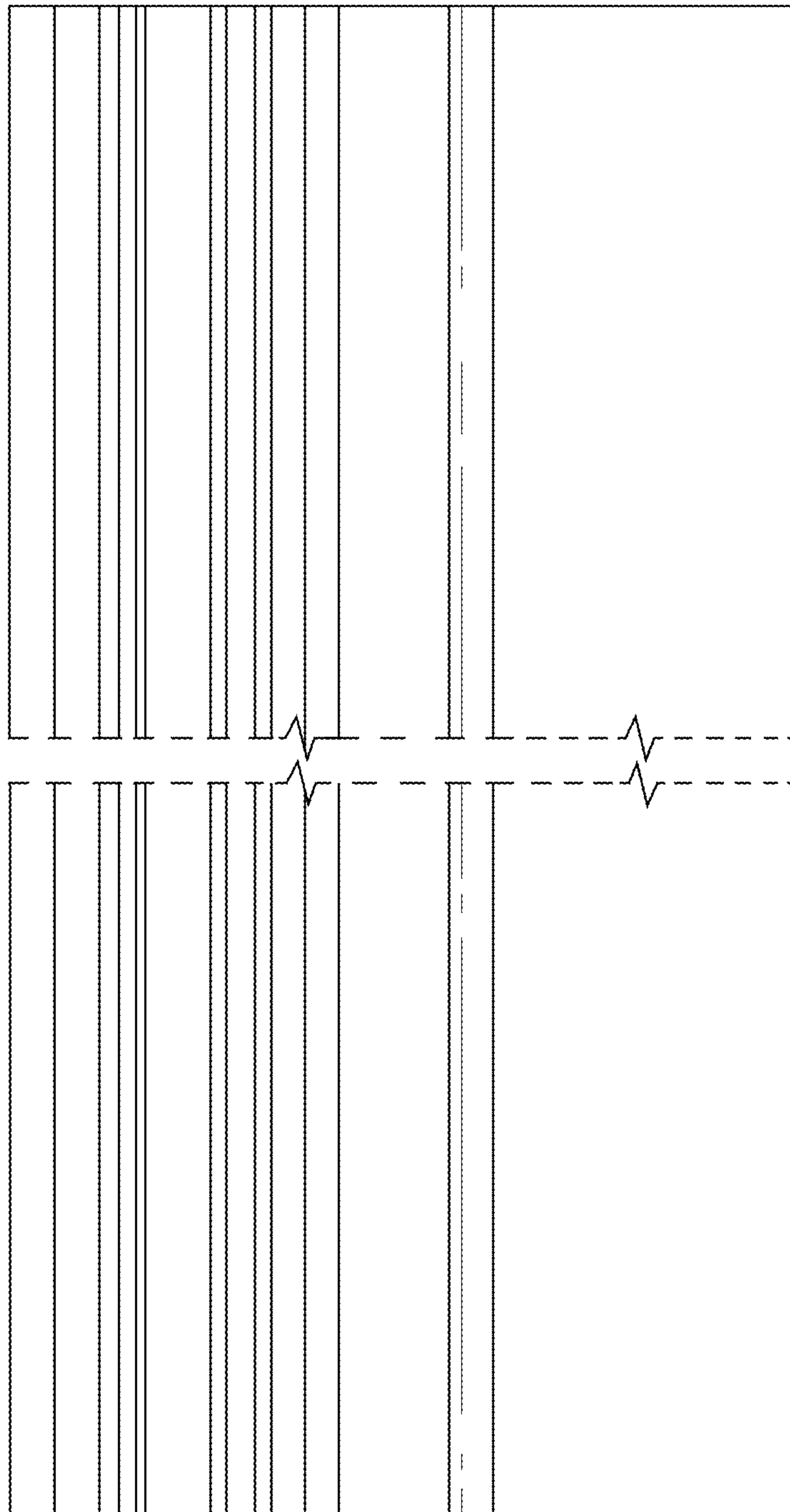

FIG. 5



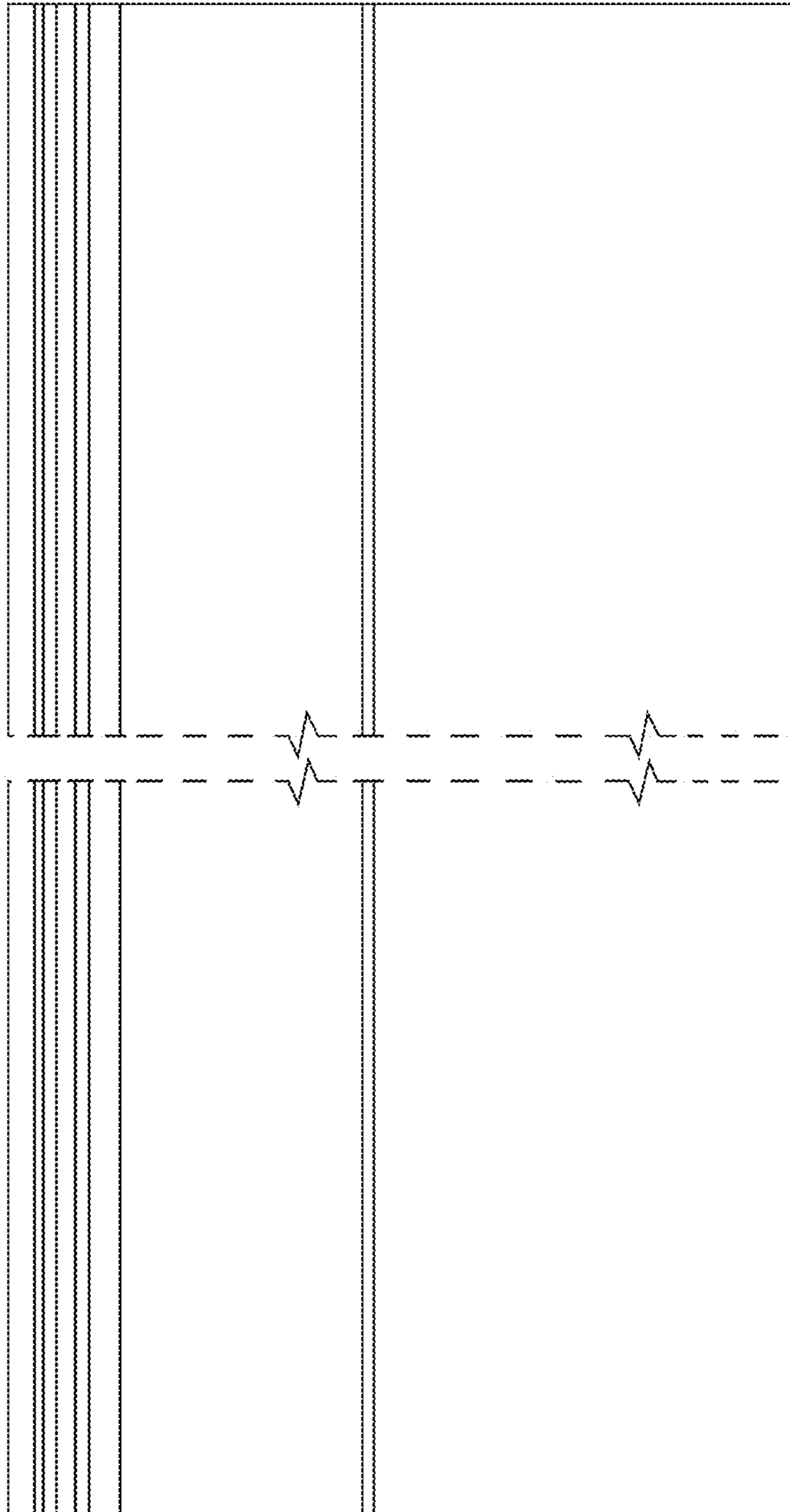

FIG. 6



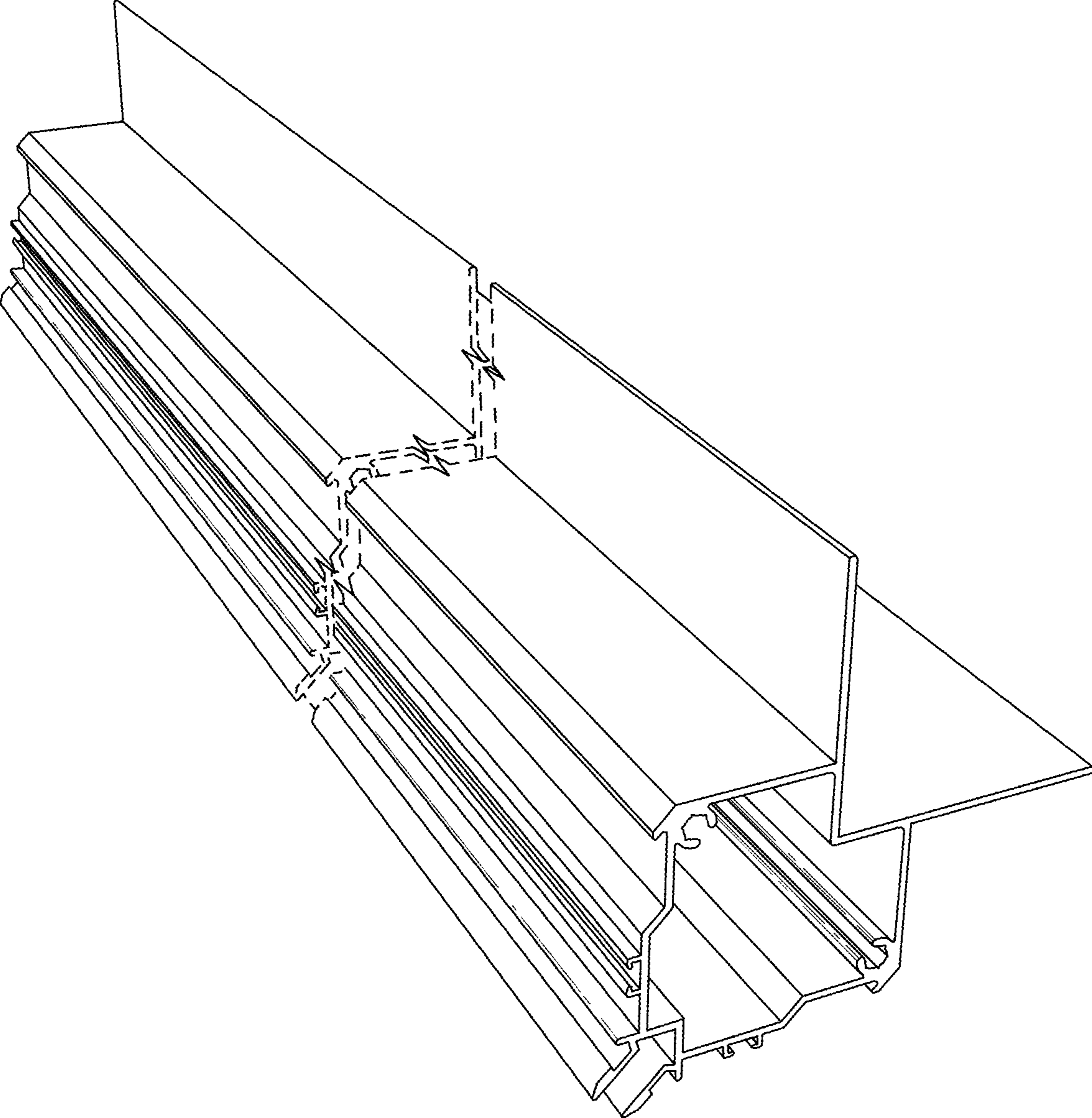

FIG. 7