

US00D898903S

(12) **United States Design Patent** (10) **Patent No.:** **US D898,903 S**
Davis et al. (45) **Date of Patent:** **** Oct. 13, 2020**

(54) **COLLECTION AND FEEDING BOTTLE**
(71) Applicant: **NEOMED, INC.**, Woodstock, GA (US)
(72) Inventors: **Benjamin M. Davis**, Woodstock, GA (US); **David A. Doornbos**, Woodstock, GA (US)
(73) Assignee: **NeoMed, Inc.**, Woodstock, GA (US)

D356,160 S 3/1995 Cautereels
5,518,143 A 5/1996 Iodice
D372,090 S * 7/1996 MacCauley D24/118
D372,091 S * 7/1996 McCallister D24/110
D374,481 S * 10/1996 McCallister D24/118
D376,208 S * 12/1996 Rasmussen D24/224
5,609,759 A 3/1997 Nohren, Jr. et al.
D382,061 S * 8/1997 Mathis D24/121
5,681,463 A 10/1997 Shimizu et al.
D393,211 S 4/1998 Mengeu

(Continued)

(**) Term: **15 Years**

Primary Examiner — David G Muller

(21) Appl. No.: **29/723,705**

(74) *Attorney, Agent, or Firm* — Dority & Manning, P.A.

(22) Filed: **Feb. 10, 2020**

(57) **CLAIM**

The ornamental design for a collection and feeding bottle, substantially as shown and described.

Related U.S. Application Data

DESCRIPTION

(62) Division of application No. 29/625,474, filed on Nov. 9, 2017, now Pat. No. Des. 878,571.

(51) **LOC (12) Cl.** **24-02**

(52) **U.S. Cl.**
USPC **D24/121**

(58) **Field of Classification Search**
USPC D24/121, 123, 224, 197; 604/317-325; D9/560, 572-575, 503; D7/615; 215/11.13

CPC .. A61J 9/00; A61J 9/003; B65D 41/04; B65D 2251/023; B65D 41/0485; B65D 41/3428
See application file for complete search history.

FIG. 1 is a top perspective view of a collection and feeding bottle according to another embodiment of the design.

FIG. 2 is a bottom perspective view of the collection and feeding bottle of FIG. 1.

FIG. 3 is a front view of the collection and feeding bottle of FIG. 1.

FIG. 4 is a rear view of the collection and feeding bottle of FIG. 1.

FIG. 5 is a first side view of the collection and feeding bottle of FIG. 1.

FIG. 6 is a second side view of the collection and feeding bottle of FIG. 1.

FIG. 7 is a first end view of the collection and feeding bottle of FIG. 1.

FIG. 8 is a second end view of the collection and feeding bottle of FIG. 1; and,

FIG. 9 is a cross-sectional view of the collection and feeding bottle taken along line 18-18 of FIG. 7.

Portions shown in broken lines are for illustrative purposes only and form no part of the claimed design.

(56) **References Cited**

U.S. PATENT DOCUMENTS

D111,253 S 9/1938 Grasty
D249,111 S 8/1978 Geyer
D267,076 S 11/1982 Hurtig
D289,975 S * 5/1987 Wendt D24/121
D313,075 S 12/1990 Mariol
D321,651 S 11/1991 Cochran
D333,268 S 2/1993 Arlinghaus et al.
5,211,973 A 5/1993 Nohren, Jr.

1 Claim, 4 Drawing Sheets

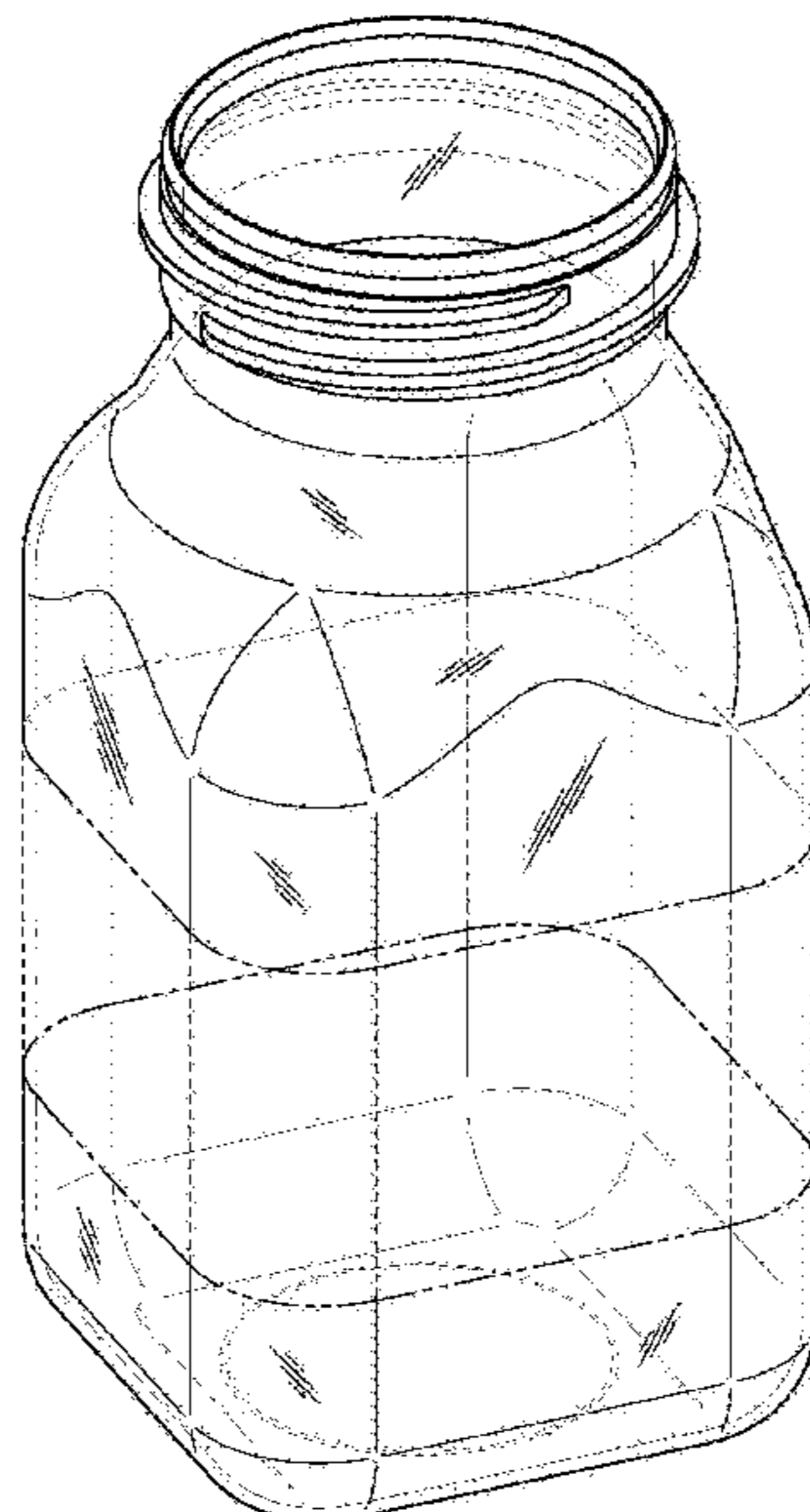

(56)

References Cited

U.S. PATENT DOCUMENTS

D401,699 S *	11/1998	Herchenbach	D24/224	D653,951 S	2/2012	Scott	
D405,698 S	2/1999	Lykken et al.		D655,166 S	3/2012	Arand et al.	
D407,817 S *	4/1999	Macauley	D24/121	D655,179 S	3/2012	Kraft et al.	
D412,281 S	7/1999	Lindsay et al.		D660,712 S	5/2012	Jenkins	
5,928,512 A	7/1999	Hatch et al.		D674,279 S	1/2013	Lembke et al.	
D413,265 S	8/1999	Hestehave et al.		D686,453 S	7/2013	Smiedt et al.	
6,004,460 A	12/1999	Palmer et al.		D686,918 S	7/2013	Lembke et al.	
D423,107 S *	4/2000	Brown	D24/197	D690,200 S	9/2013	Arand et al.	
D423,366 S	4/2000	Gans		D692,277 S	10/2013	Smiedt et al.	
D428,339 S	7/2000	Johnston et al.		D692,724 S	11/2013	Smiedt et al.	
D428,813 S	8/2000	Haley		D695,416 S *	12/2013	Saliaris	D24/224
6,165,382 A	12/2000	Perez Mendez et al.		D701,728 S	4/2014	Stanley et al.	
D437,229 S	2/2001	Andrew		D701,730 S	4/2014	Stanley et al.	
D439,345 S *	3/2001	Herchenbach	D24/224	D720,225 S	12/2014	Gieske et al.	
D440,318 S	4/2001	Meyers et al.		D721,586 S	1/2015	Sharpe et al.	
D456,714 S	5/2002	Brauner et al.		D724,443 S	3/2015	Sharpe et al.	
6,569,329 B1	5/2003	Nohren, Jr.		D724,748 S	3/2015	Roehrig	
D481,640 S	11/2003	Biesecker		D728,783 S *	5/2015	Logue	D24/121
D482,793 S *	11/2003	Oyama	D24/121	D729,593 S	5/2015	Myoung	
D488,225 S *	4/2004	Roberson	D24/108	D730,533 S *	5/2015	Wilson	D24/197
D491,068 S	6/2004	Heliste et al.		D735,046 S	7/2015	De Lorme	
D491,069 S	6/2004	Heliste et al.		D736,641 S	8/2015	Manne et al.	
D491,070 S	6/2004	Boldrini et al.		D736,646 S	8/2015	Andersson et al.	
D501,140 S	1/2005	Fung et al.		D740,120 S	10/2015	Ghouyel	
D502,844 S	3/2005	Rohe		D742,175 S	11/2015	Rashid et al.	
D505,329 S	5/2005	Wadalawala et al.		D743,791 S	11/2015	Andersson	
D513,185 S	12/2005	Ruiz		D748,812 S *	2/2016	Kenney	D24/224
D520,363 S	5/2006	Perez		9,284,106 B2 *	3/2016	Wilkes	B65D 75/5883
D526,565 S	8/2006	Griffin et al.		D757,956 S *	5/2016	Brandenburger	D24/224
D531,903 S	11/2006	Haubein		D759,267 S *	6/2016	Brandenburger	D24/224
D532,311 S	11/2006	Yourist		D764,920 S	8/2016	Marantis et al.	
D538,597 S	3/2007	Kim		D765,472 S	9/2016	Metaxatos et al.	
D539,651 S	4/2007	Snyder		D766,112 S	9/2016	Baker et al.	
D548,607 S	8/2007	Langbein et al.		D767,405 S	9/2016	Orset	
D556,038 S	11/2007	Chupak		D779,955 S	2/2017	Miller et al.	
D558,583 S	1/2008	Langbein et al.		D780,588 S	3/2017	Miller et al.	
D558,584 S	1/2008	Blank		D780,589 S	3/2017	Miller et al.	
D569,734 S	5/2008	Imperato et al.		D783,407 S	4/2017	Marantis et al.	
D571,213 S	6/2008	Le Bras-Brown et al.		D787,945 S	5/2017	Rashid et al.	
D571,223 S	6/2008	Imperato et al.		D789,745 S	6/2017	Rashid et al.	
D571,662 S	6/2008	Clark et al.		D794,392 S	8/2017	Rashid et al.	
D579,775 S	11/2008	Dixon et al.		D794,468 S	8/2017	Ivie	
D580,708 S	11/2008	George		D796,261 S	9/2017	Khalifa et al.	
D582,774 S	12/2008	Klemm et al.		D798,160 S	9/2017	Miller et al.	
D584,107 S	1/2009	George		D798,725 S	10/2017	Stoiber	
D590,721 S	4/2009	Martinez De San Vicente		9,789,988 B2 *	10/2017	Wilson	A61J 9/005
D591,154 S	4/2009	Darr et al.		D803,059 S	11/2017	Matthieu	
D595,417 S	6/2009	Driver et al.		D803,071 S	11/2017	Telu-Zoltner	
D602,369 S	10/2009	Potts et al.		D808,815 S	1/2018	Arkin et al.	
D602,785 S	10/2009	Rothberg et al.		D815,541 S	4/2018	Harris et al.	
D608,642 S	1/2010	Black		D818,370 S	5/2018	Harris et al.	
D612,256 S	3/2010	Wurster et al.		D829,558 S	10/2018	Rothfos	
D612,257 S	3/2010	Wurster et al.		D833,292 S	11/2018	Arzano et al.	
D615,360 S	5/2010	Joy et al.		D833,293 S	11/2018	Lin	
7,914,512 B2	3/2011	Orth et al.		D848,852 S	5/2019	Simon et al.	
D636,678 S *	4/2011	Baird	D24/224	D848,853 S	5/2019	Simon et al.	
D642,478 S	8/2011	Ehmiann		D856,153 S	8/2019	Liu et al.	
				D863,969 S	10/2019	Sterling	
				D864,726 S	10/2019	Eble	

* cited by examiner

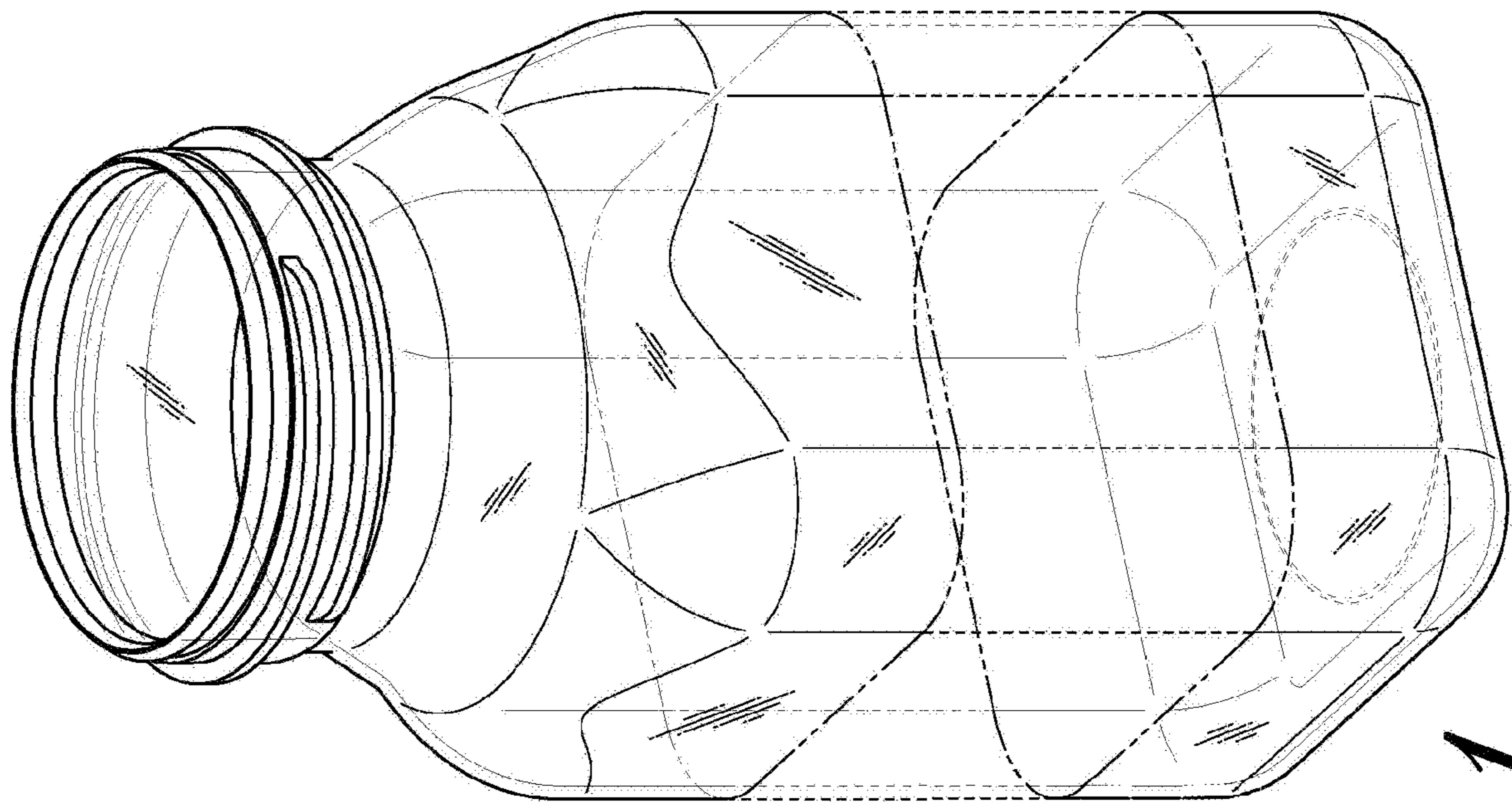
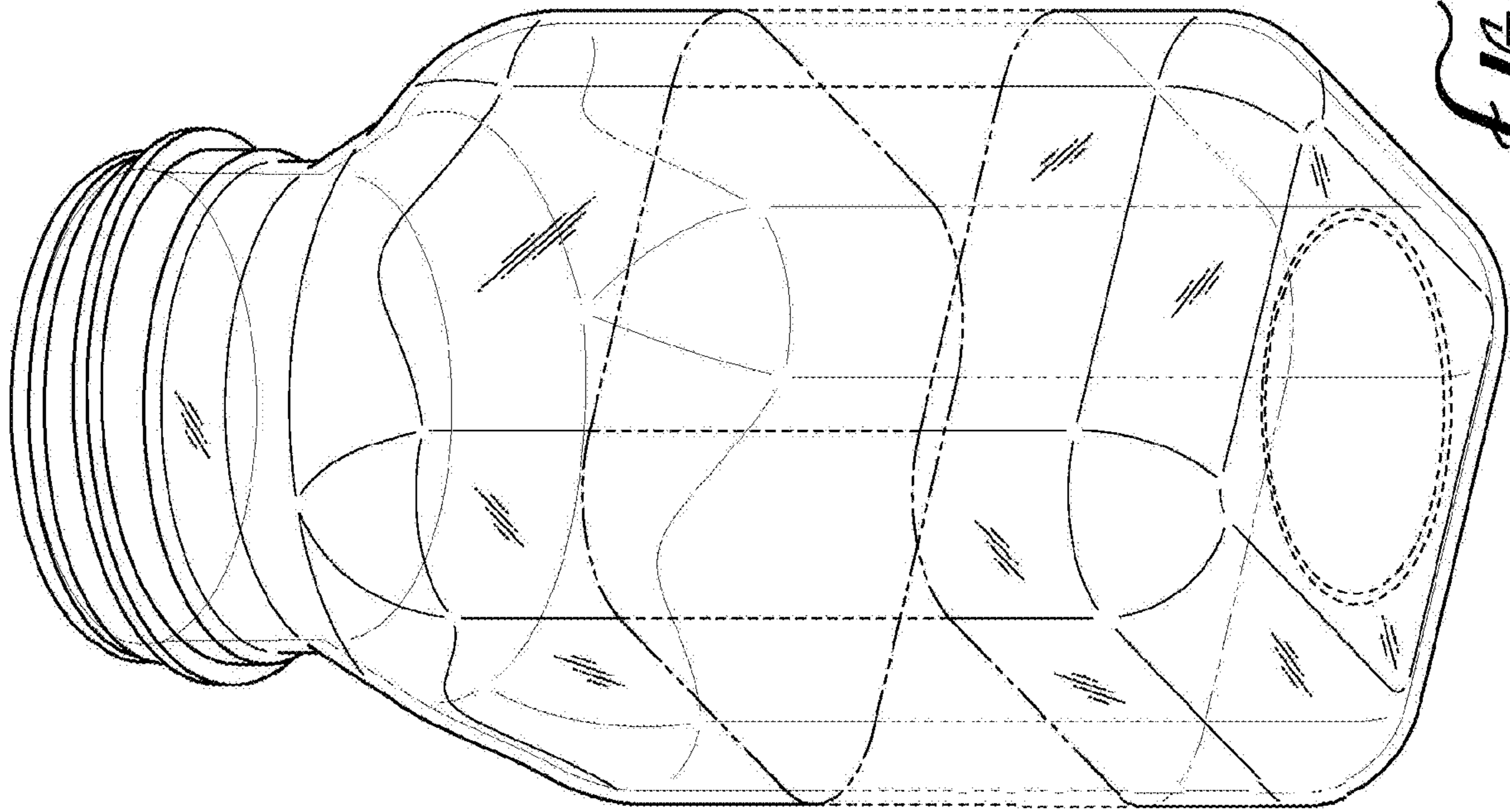

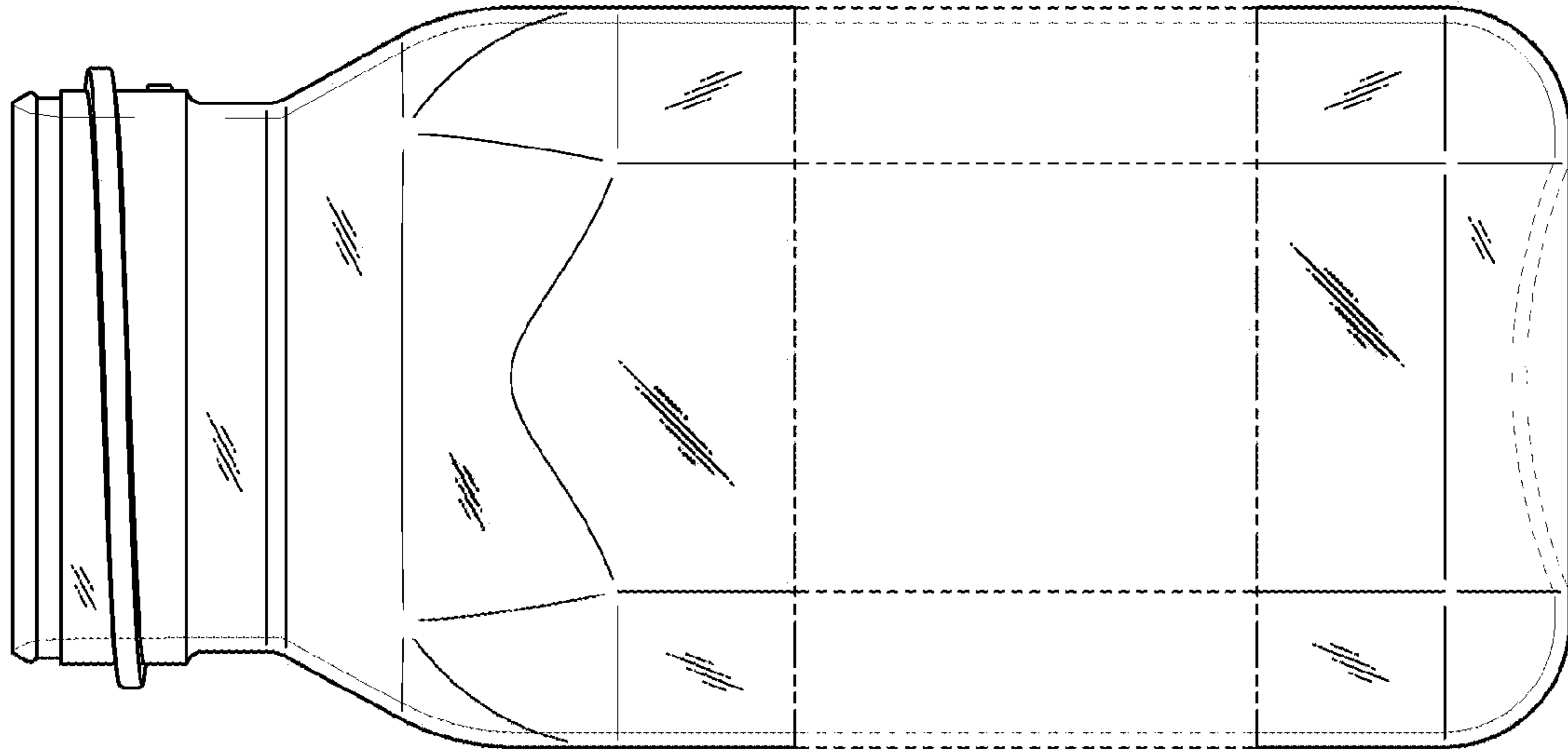

FIG. 4

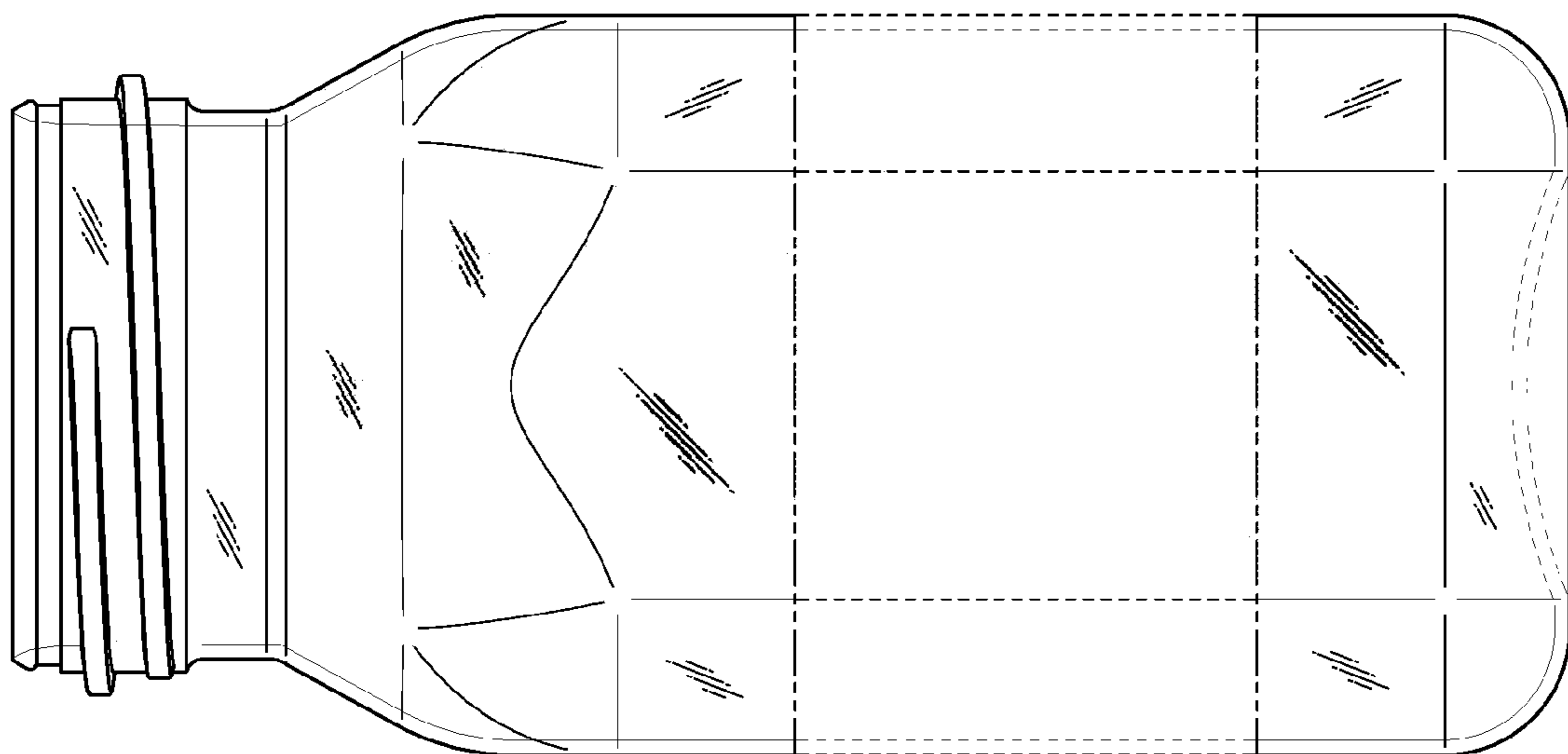

FIG. 3

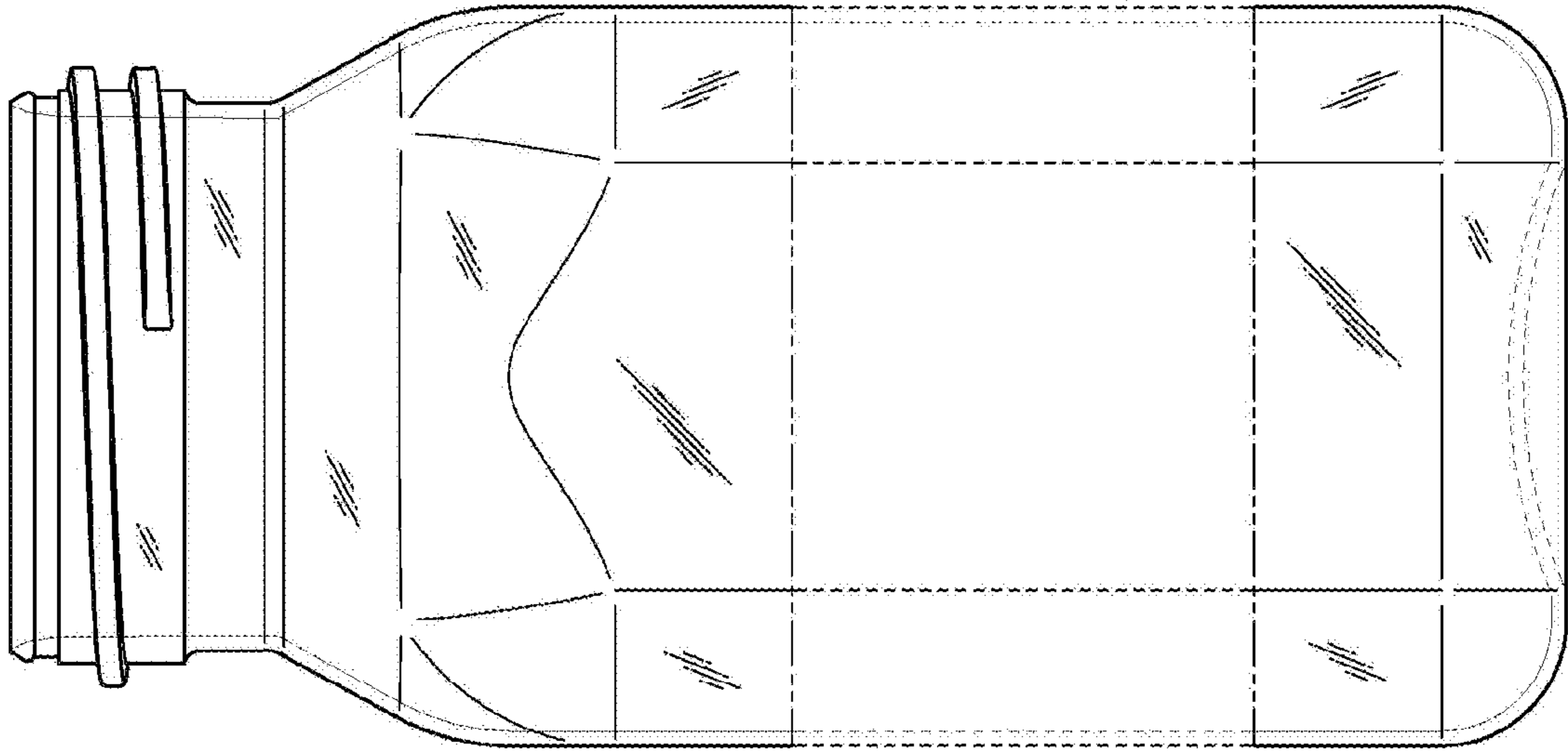

FIG. 6

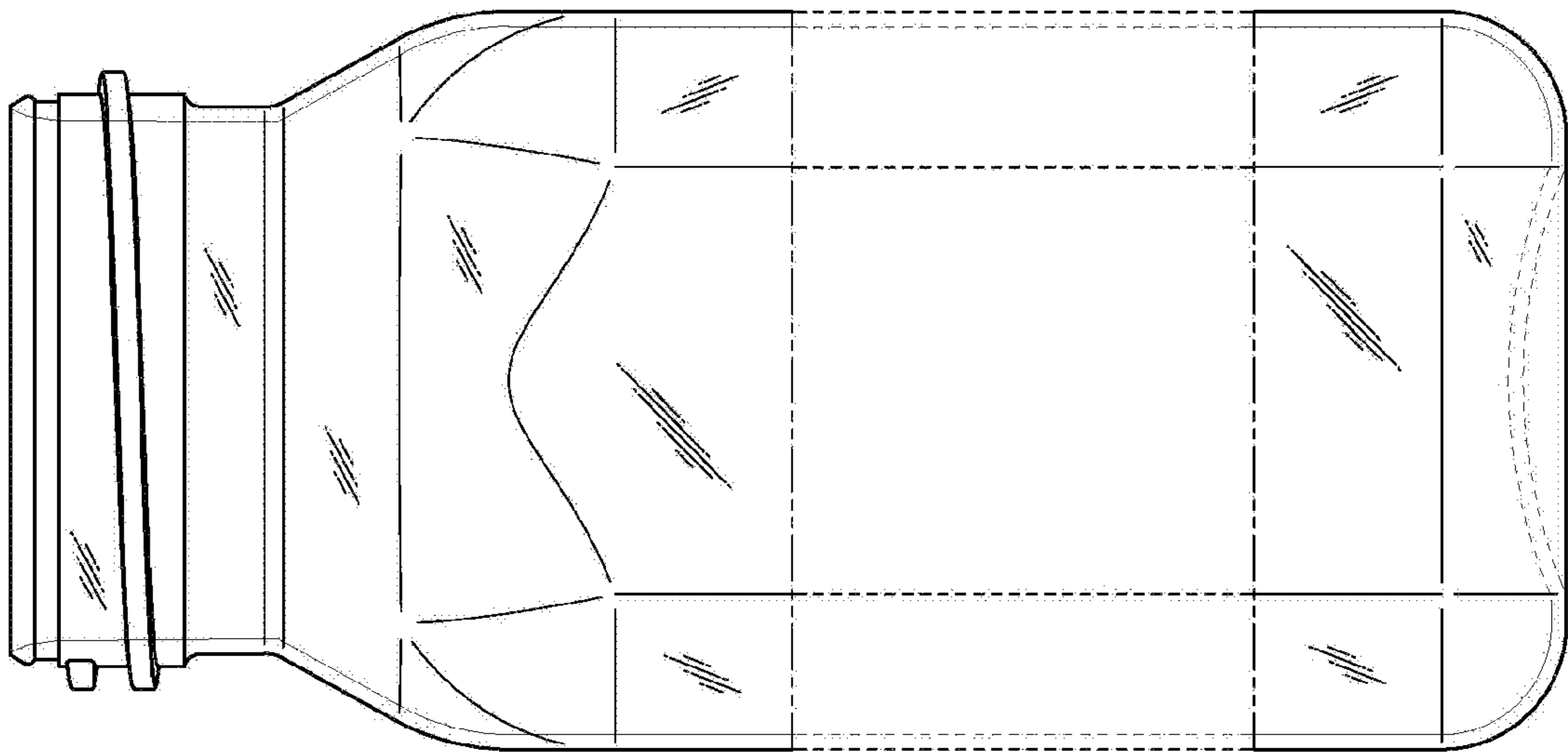

FIG. 5

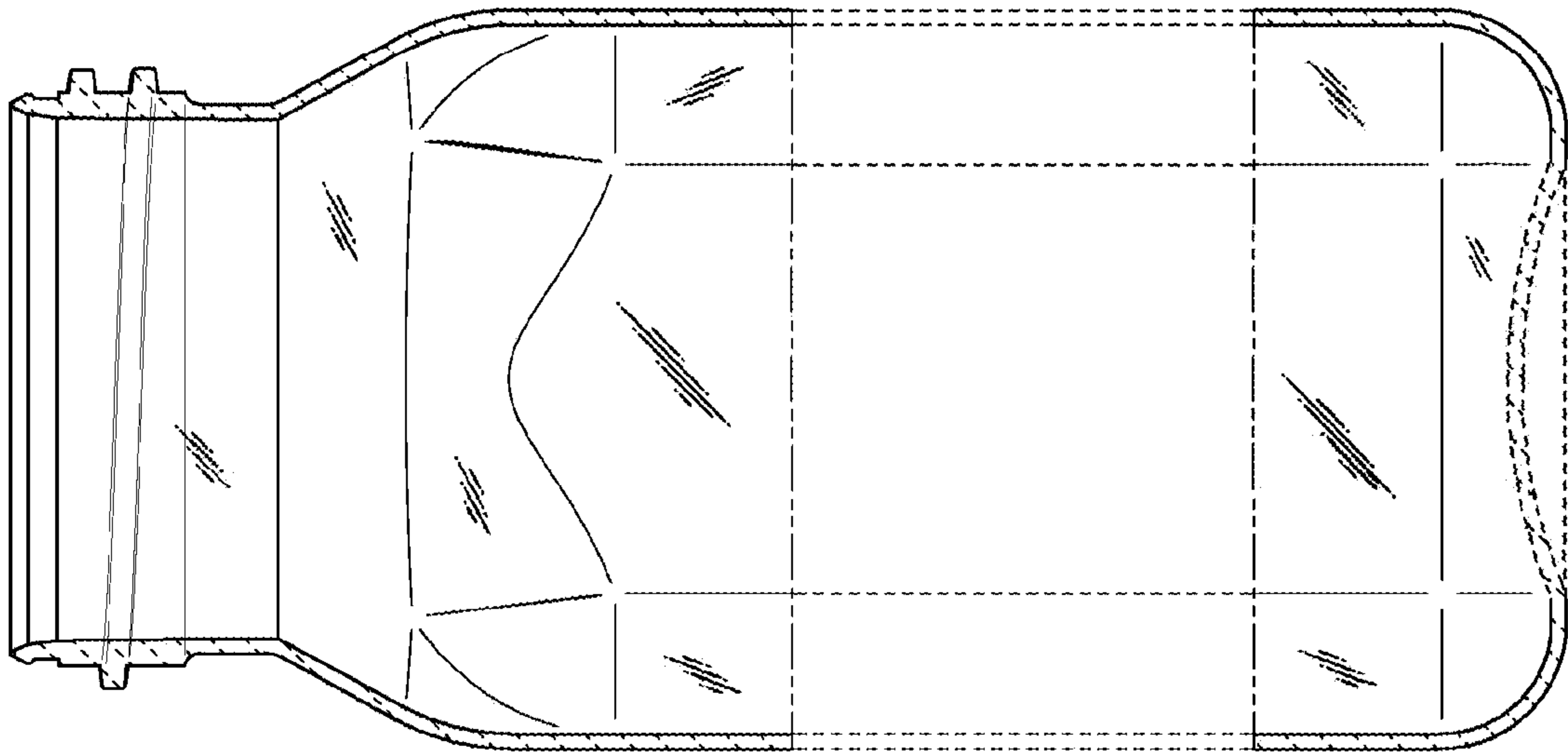
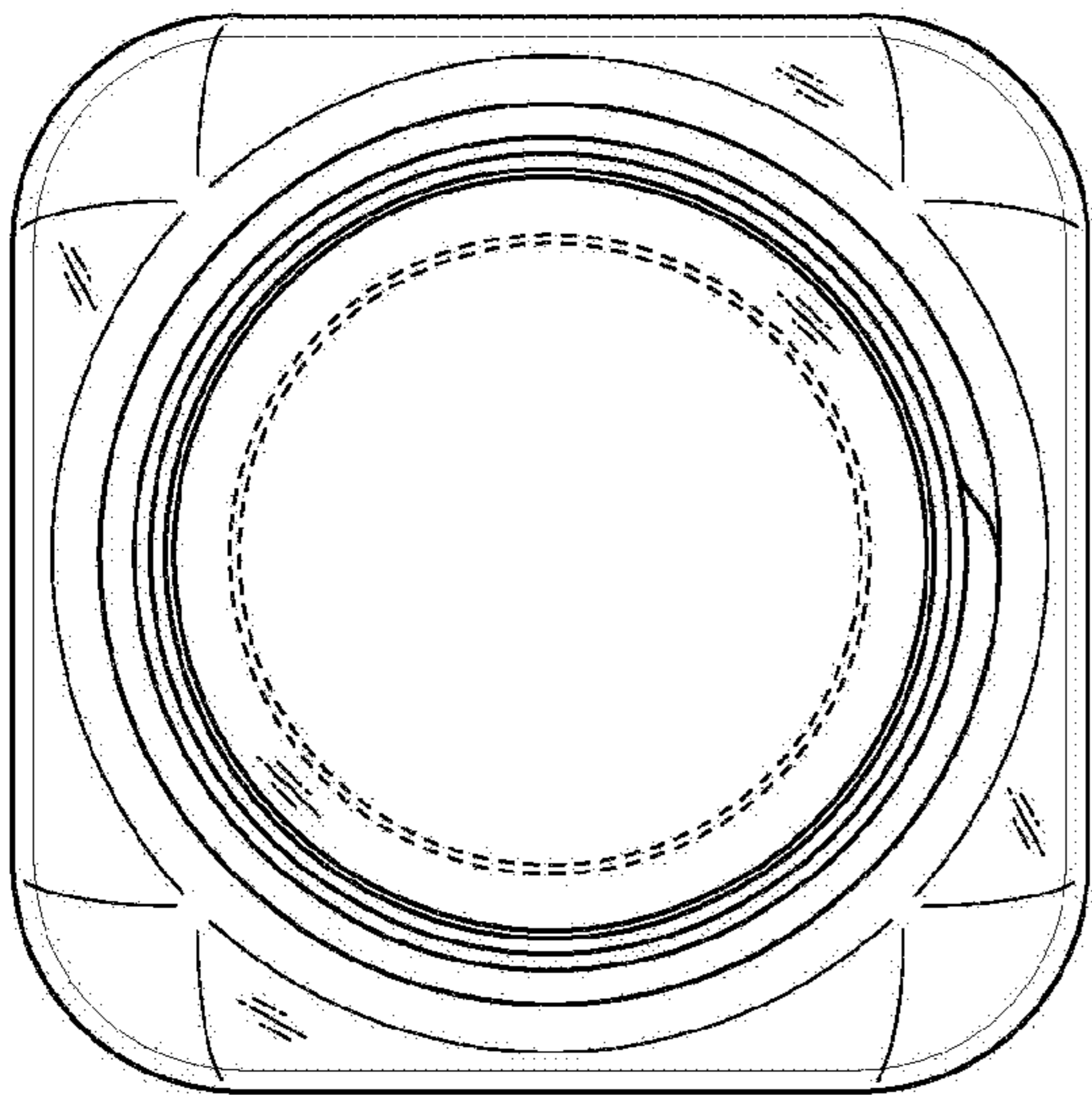

FIG. 9



18

FIG. 7

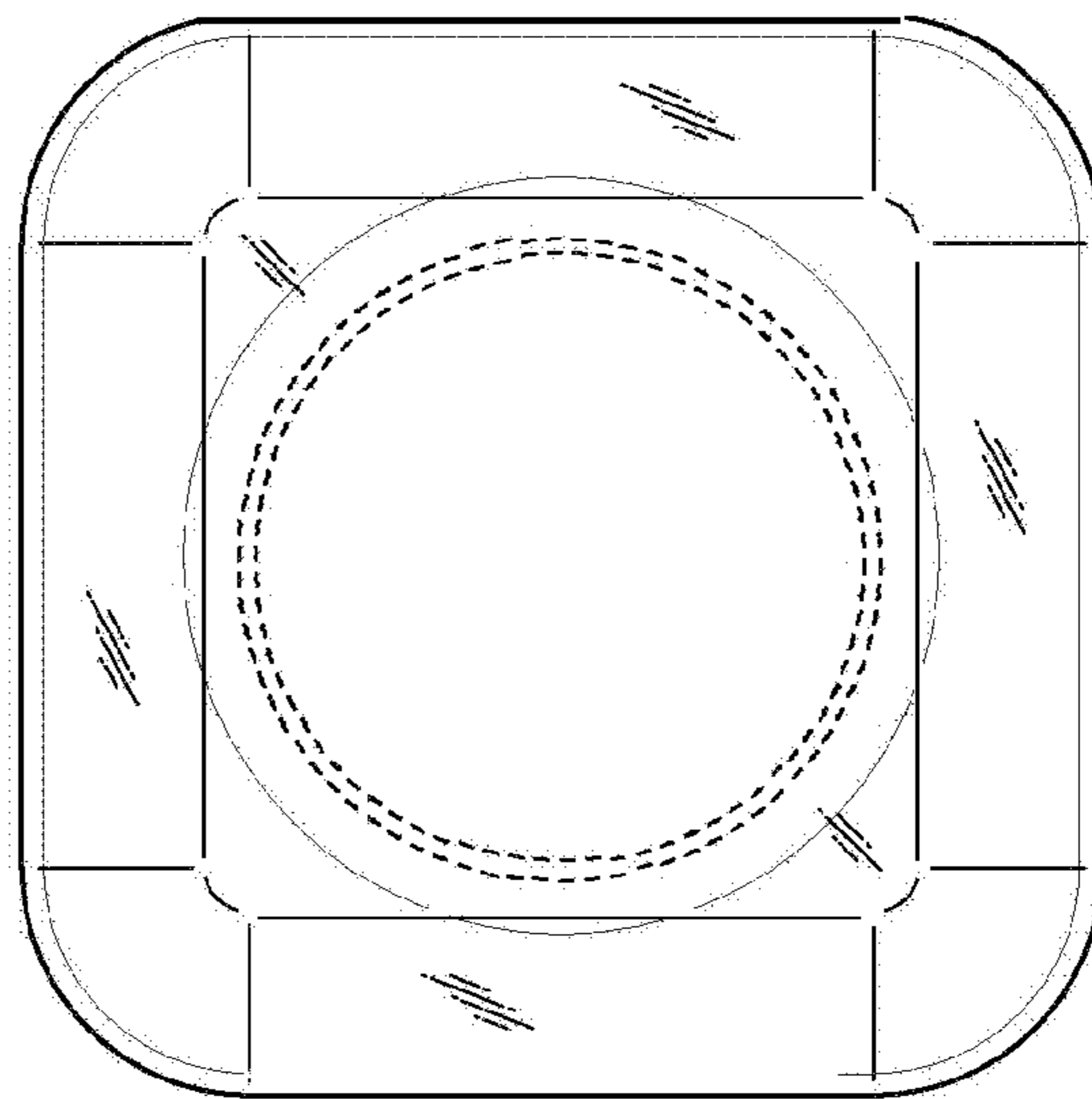

FIG. 8

18