



US00D898899S

(12) **United States Design Patent**
Rummery

(10) **Patent No.:** **US D898,899 S**

(45) **Date of Patent:** **** Oct. 13, 2020**

(54) **NASAL MASK**

(71) Applicant: **ResMed Pty Ltd**, Bella Vista, New South Wales (AU)

(72) Inventor: **Gerard Michael Rummery**, Woodford (AU)

(73) Assignee: **ResMed Pty Ltd**, Bella Vista (AU)

(**) Term: **15 Years**

(21) Appl. No.: **29/598,512**

(22) Filed: **Mar. 27, 2017**

(51) **LOC (12) Cl.** **24-02**

(52) **U.S. Cl.**

USPC **D24/110.4**

(58) **Field of Classification Search**

USPC D24/110-110.6, 127, 129; D29/110

CPC A61M 16/0616; A61M 16/0633; A61M

16/06; A61M 16/0666; A61M 16/0683;

A61M 16/0605; A61M 16/0622; A61M

16/0644; A61M 16/0875; A61M 16/0816;

A61M 16/08; B63C 11/205; B63C 11/16;

B63C 11/186; B63C 11/12

See application file for complete search history.

(56) **References Cited**

U.S. PATENT DOCUMENTS

D412,745 S * 8/1999 Scheu D24/110.4

D685,463 S * 7/2013 Veliss et al.

D742,501 S * 11/2015 Chen D24/110

D742,502 S * 11/2015 Chen D24/110

D743,021 S * 11/2015 Chen D24/110

D745,139 S * 12/2015 Chen D24/110
2011/0265796 A1 11/2011 Amarasinghe et al.
2016/0287829 A1* 10/2016 Whitehead A61M 16/0683

* cited by examiner

Primary Examiner — Sheryl Lane

Assistant Examiner — Aula Soroush

(74) *Attorney, Agent, or Firm* — Nixon & Vanderhye P.C.

(57) **CLAIM**

The ornamental design for a nasal mask, as shown and described.

DESCRIPTION

FIG. 1 is a front perspective view of a nasal mask showing a first embodiment of our new design;

FIG. 2 is an enlarged front view thereof shown in isolation;

FIG. 3 is a rear view thereof;

FIG. 4 is a top view thereof;

FIG. 5 is a bottom view thereof;

FIG. 6 is a left side view thereof;

FIG. 7 is a right side view thereof;

FIG. 8 is a bottom perspective view thereof;

FIG. 9 is a front perspective view of a nasal mask showing a second embodiment of our new design;

FIG. 10 is an enlarged front view thereof shown in isolation;

FIG. 11 is a rear view thereof;

FIG. 12 is a top view thereof;

FIG. 13 is a bottom view thereof;

FIG. 13 is a left side view thereof;

FIG. 14 is a right side view thereof;

FIG. 15 is a bottom perspective view thereof; and,

FIG. 16 is a bottom perspective view thereof.

The broken lines represent environmental structure of the nasal mask and do not form a portion of the claimed design.

1 Claim, 10 Drawing Sheets

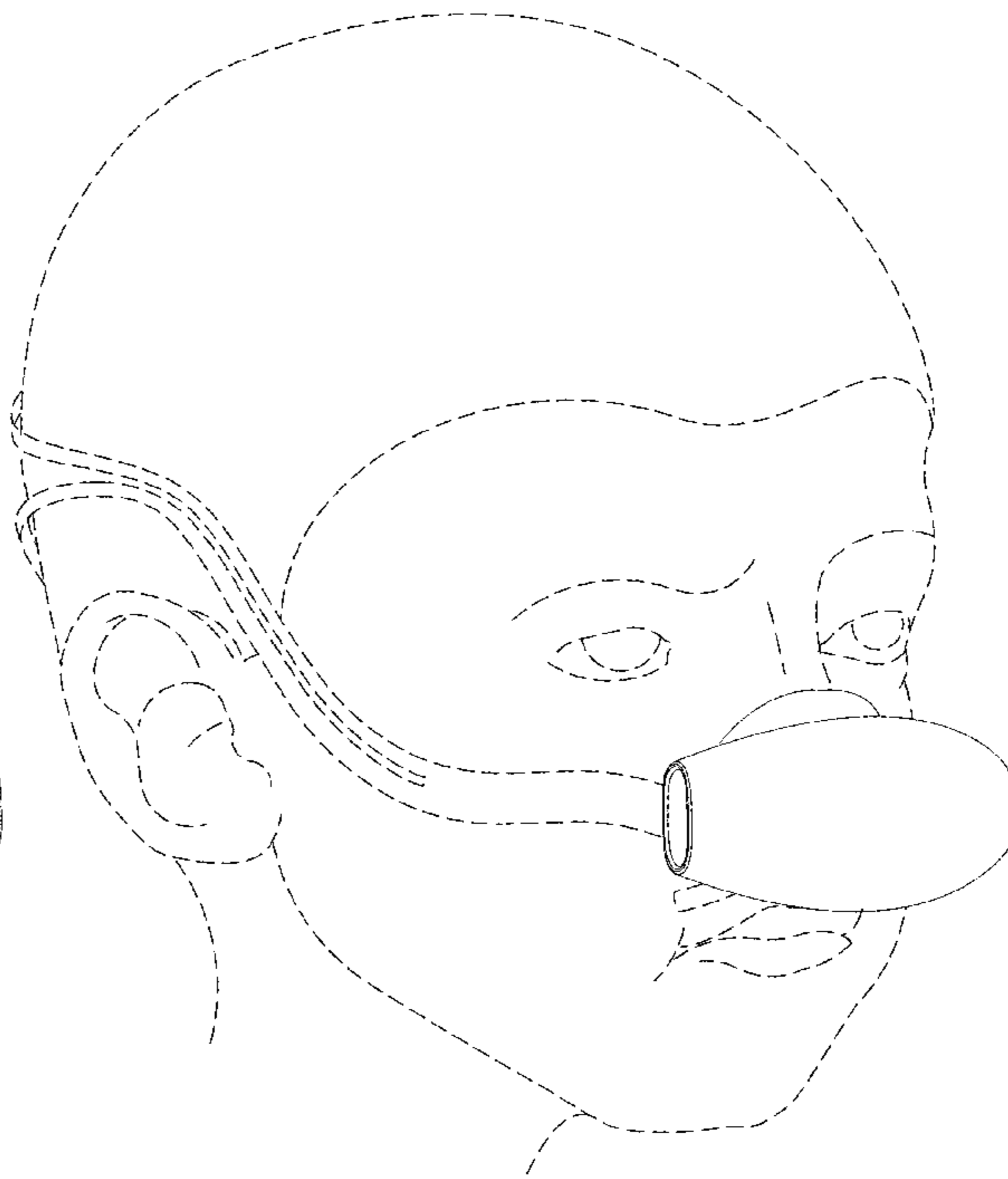
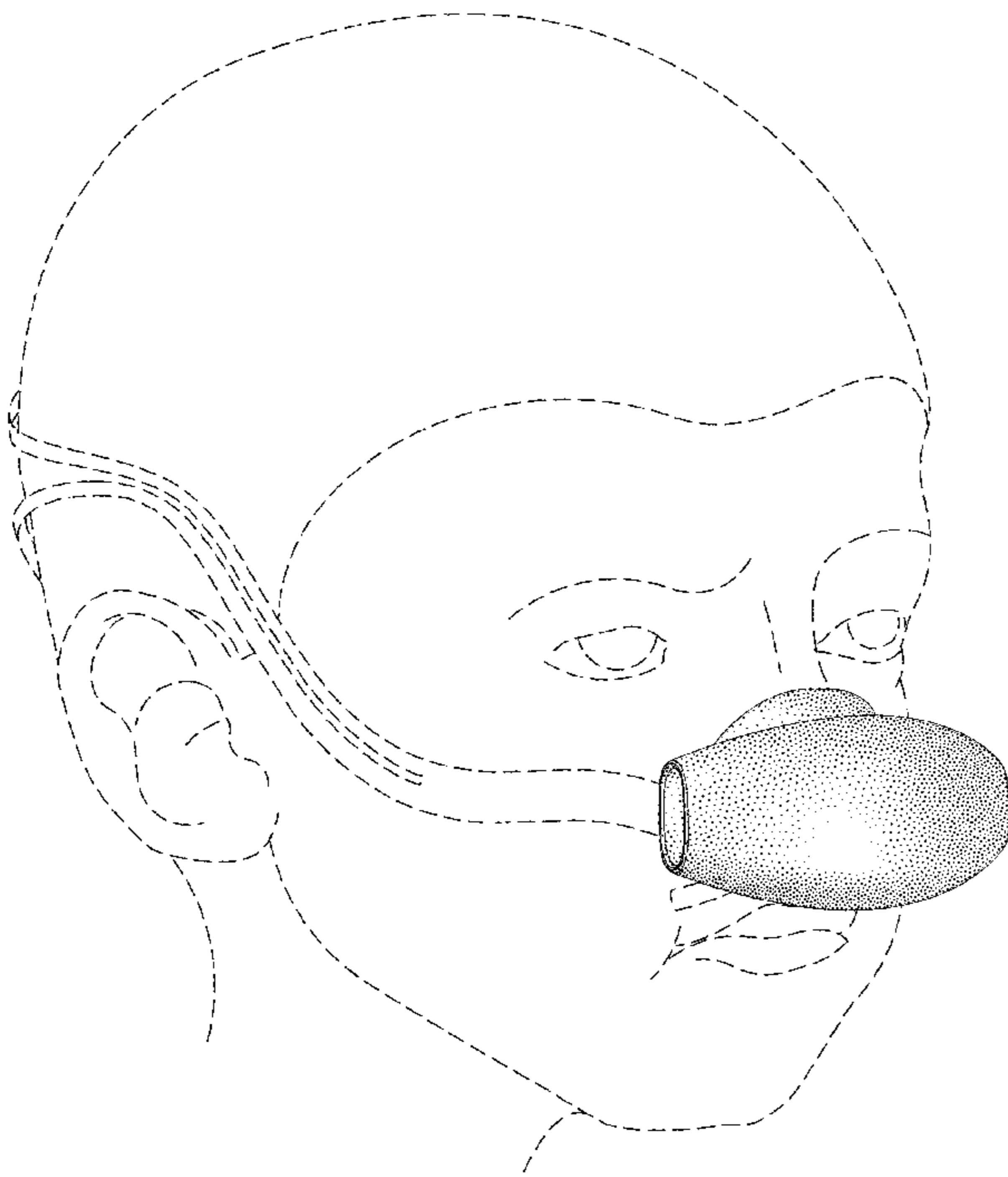

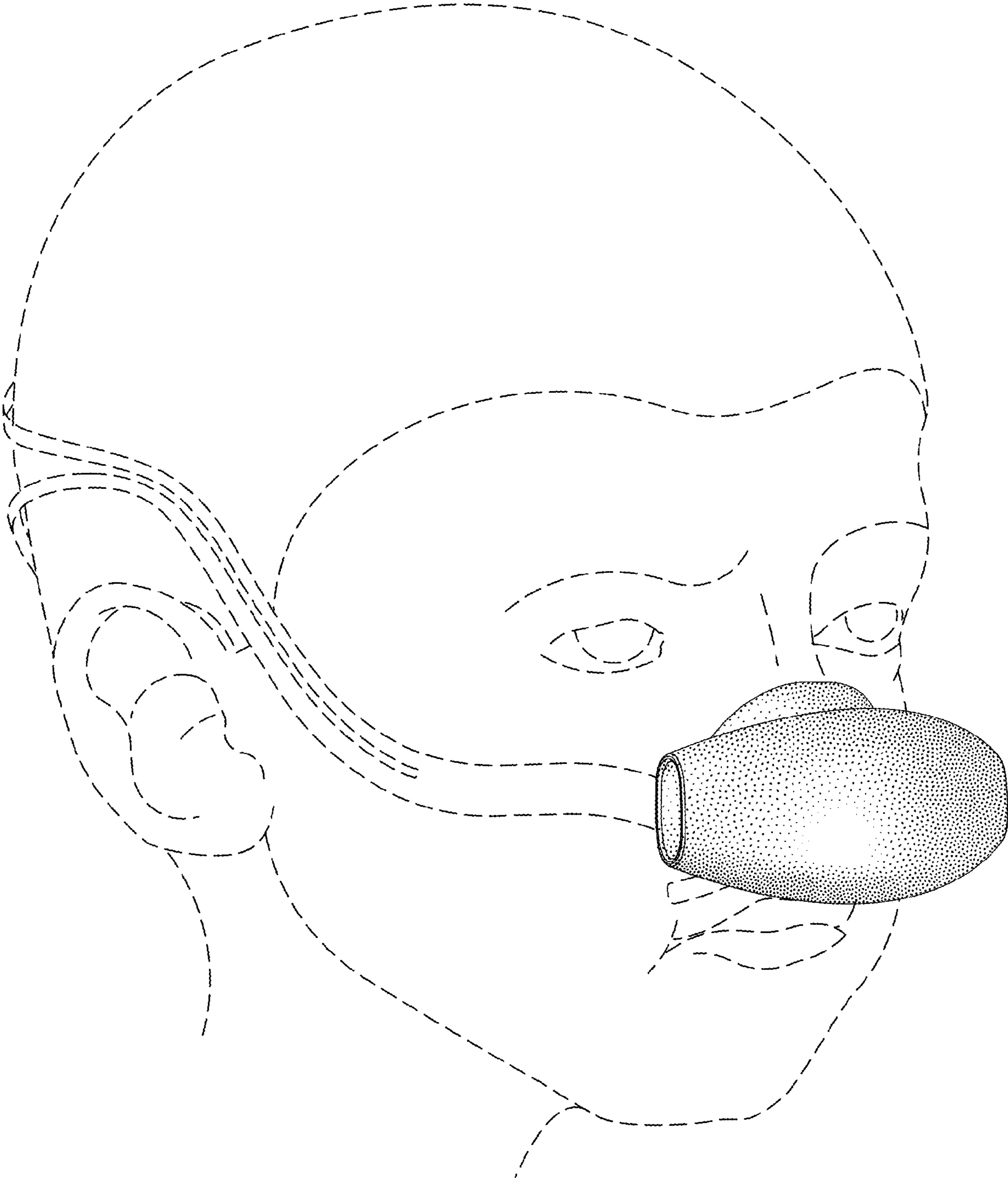

FIG. 1

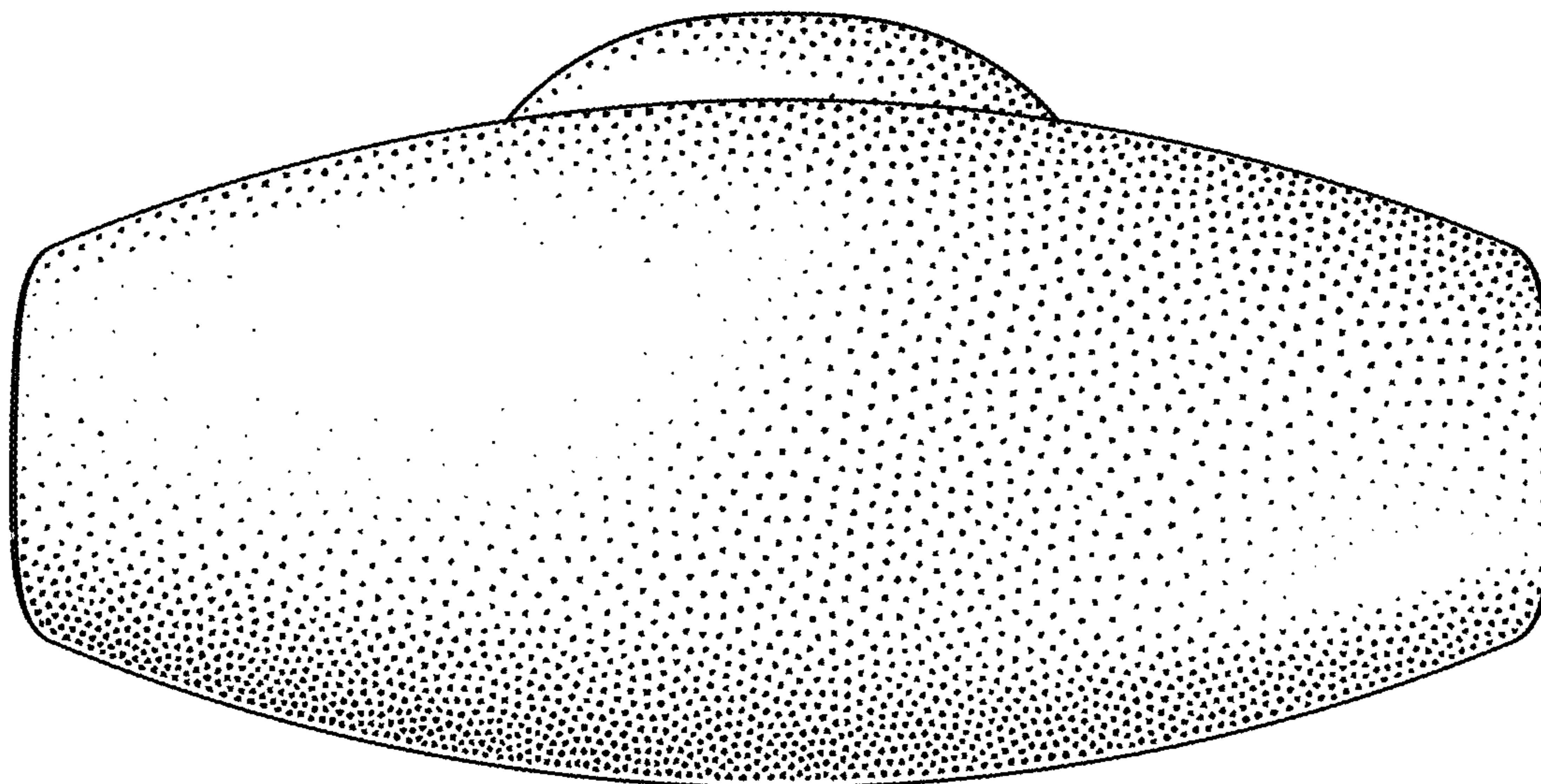

FIG. 2

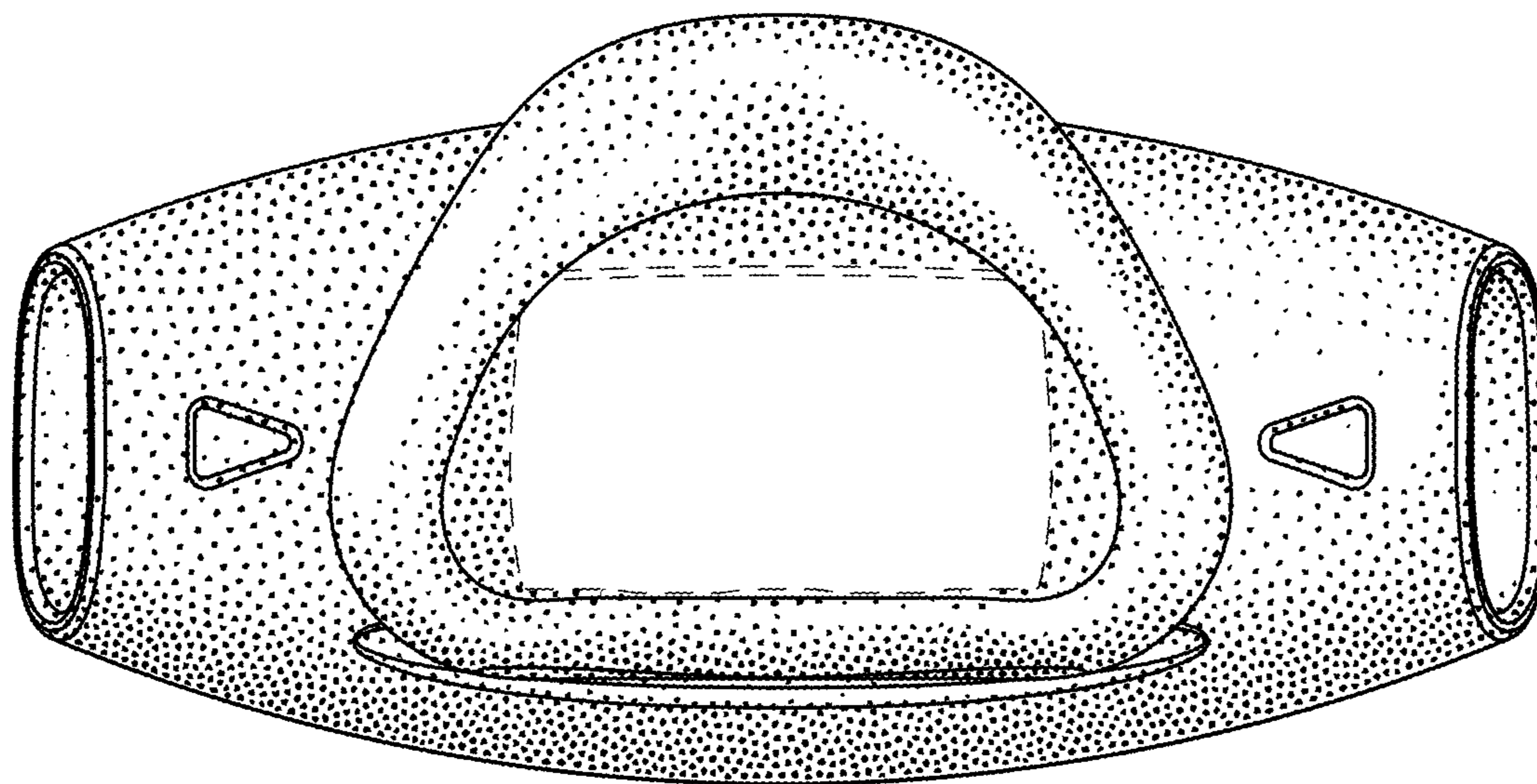

FIG. 3

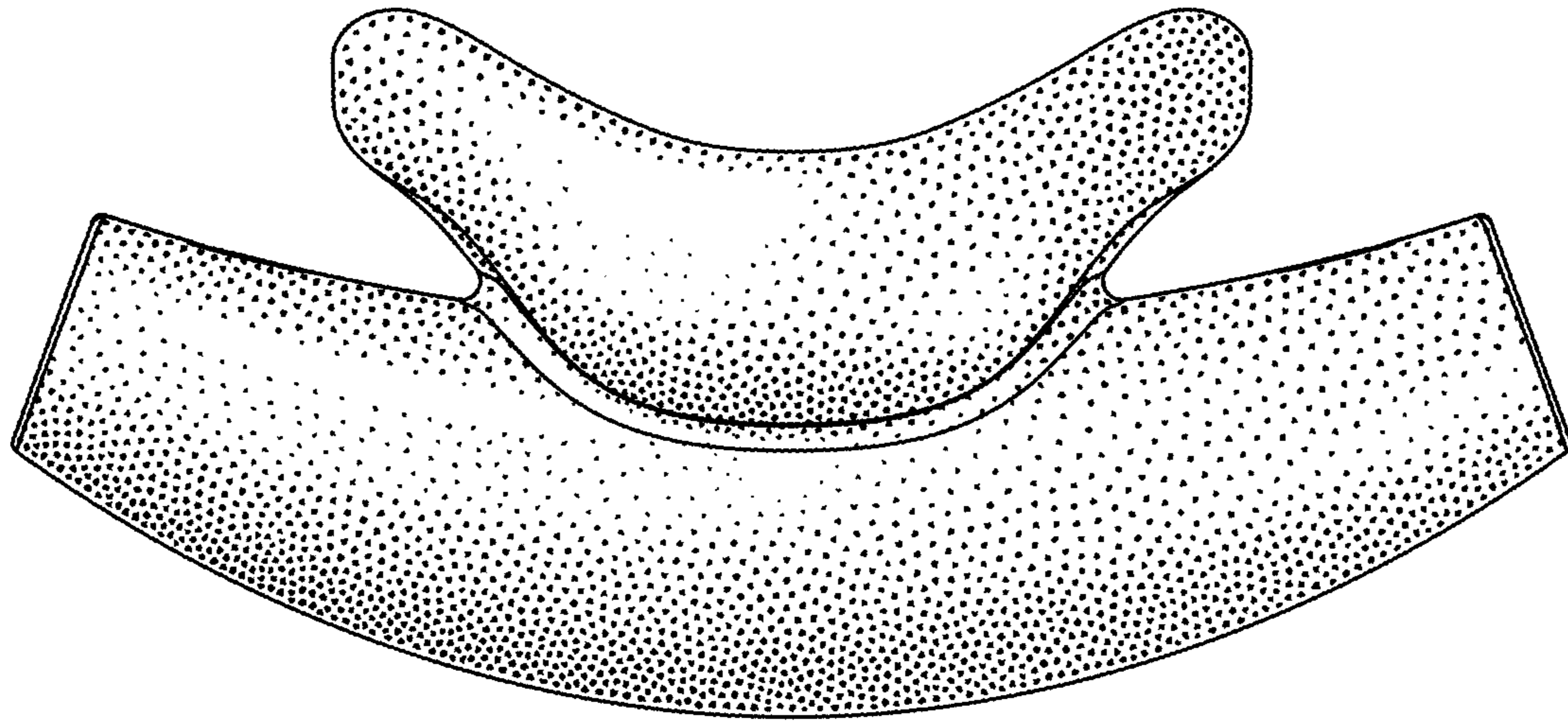

FIG. 4

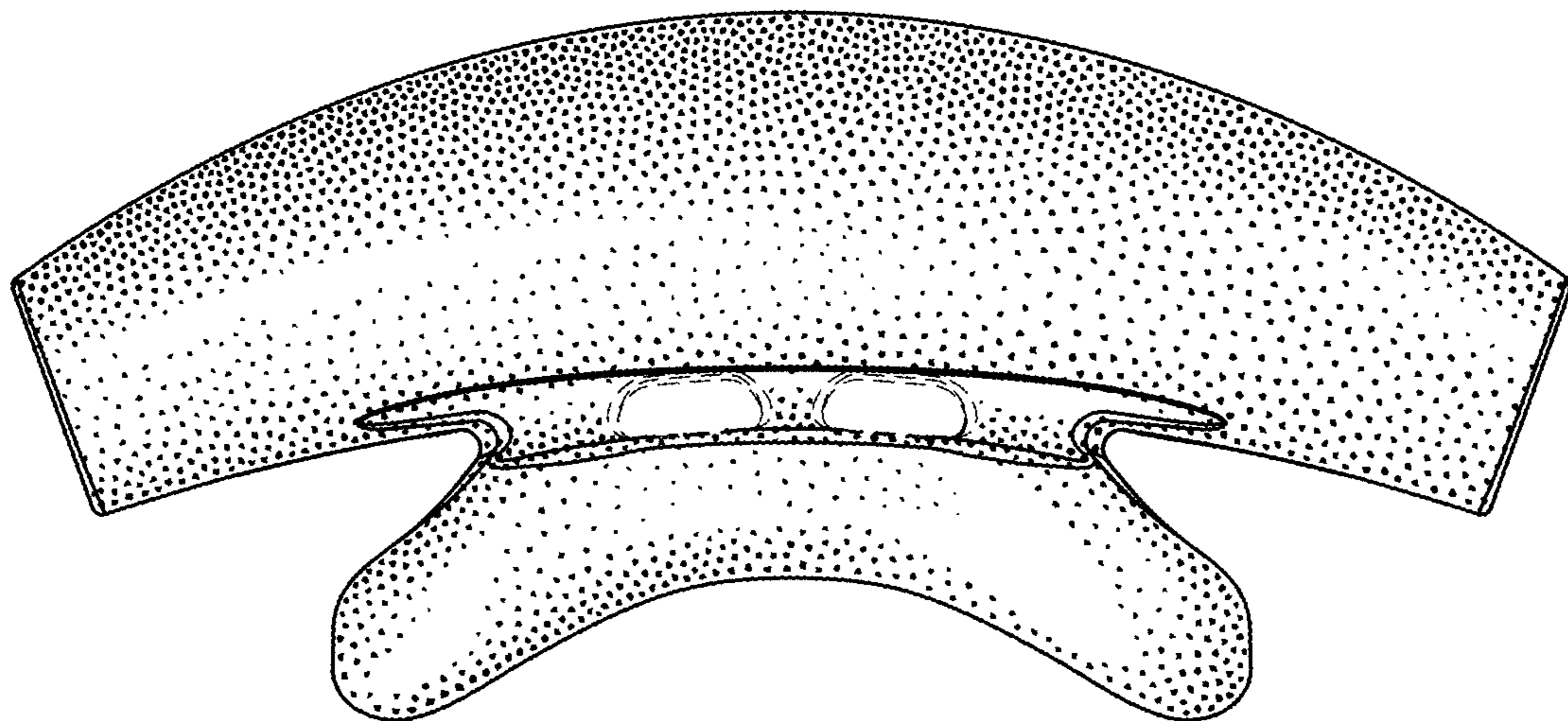

FIG. 5

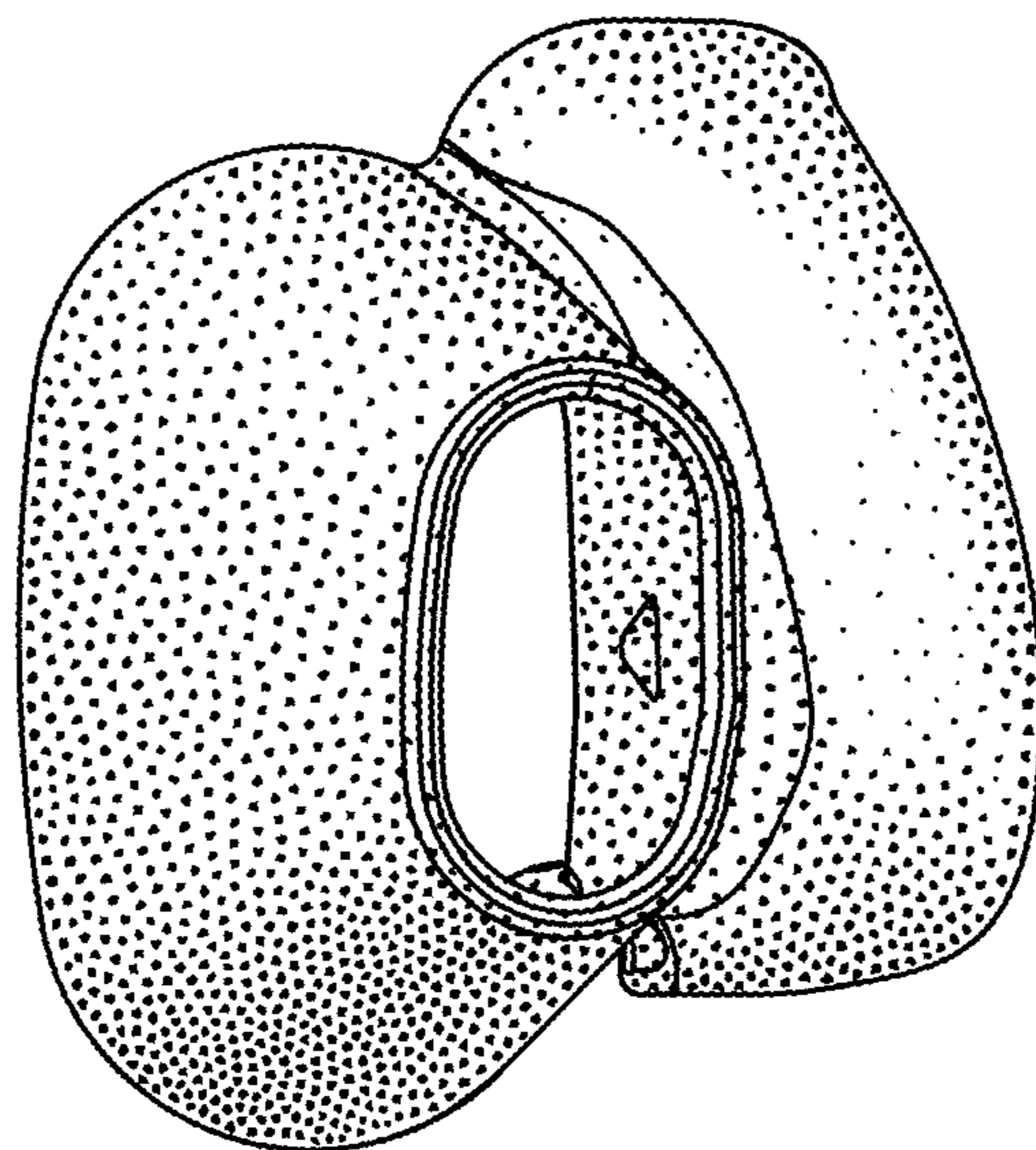

FIG. 6

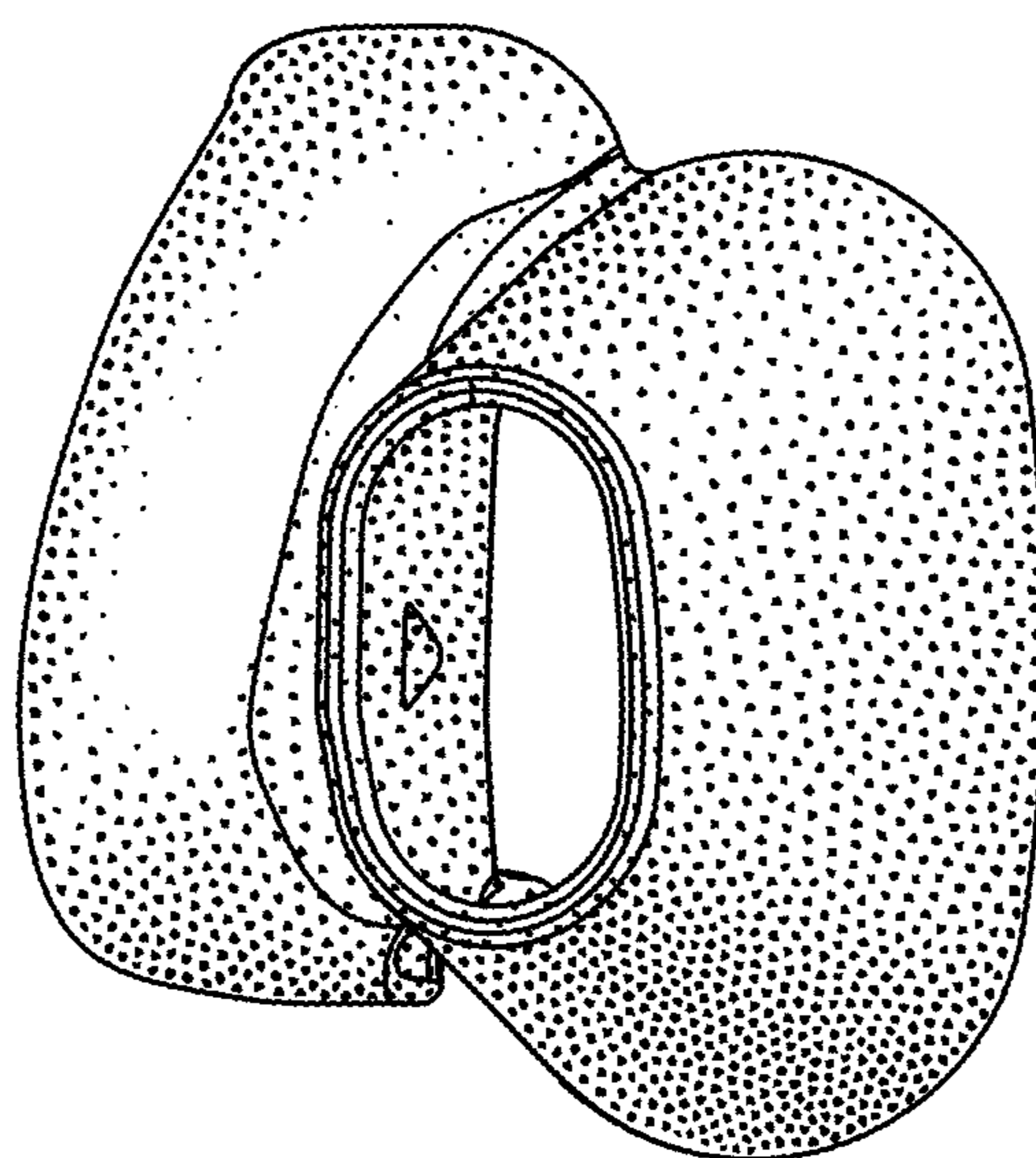

FIG. 7

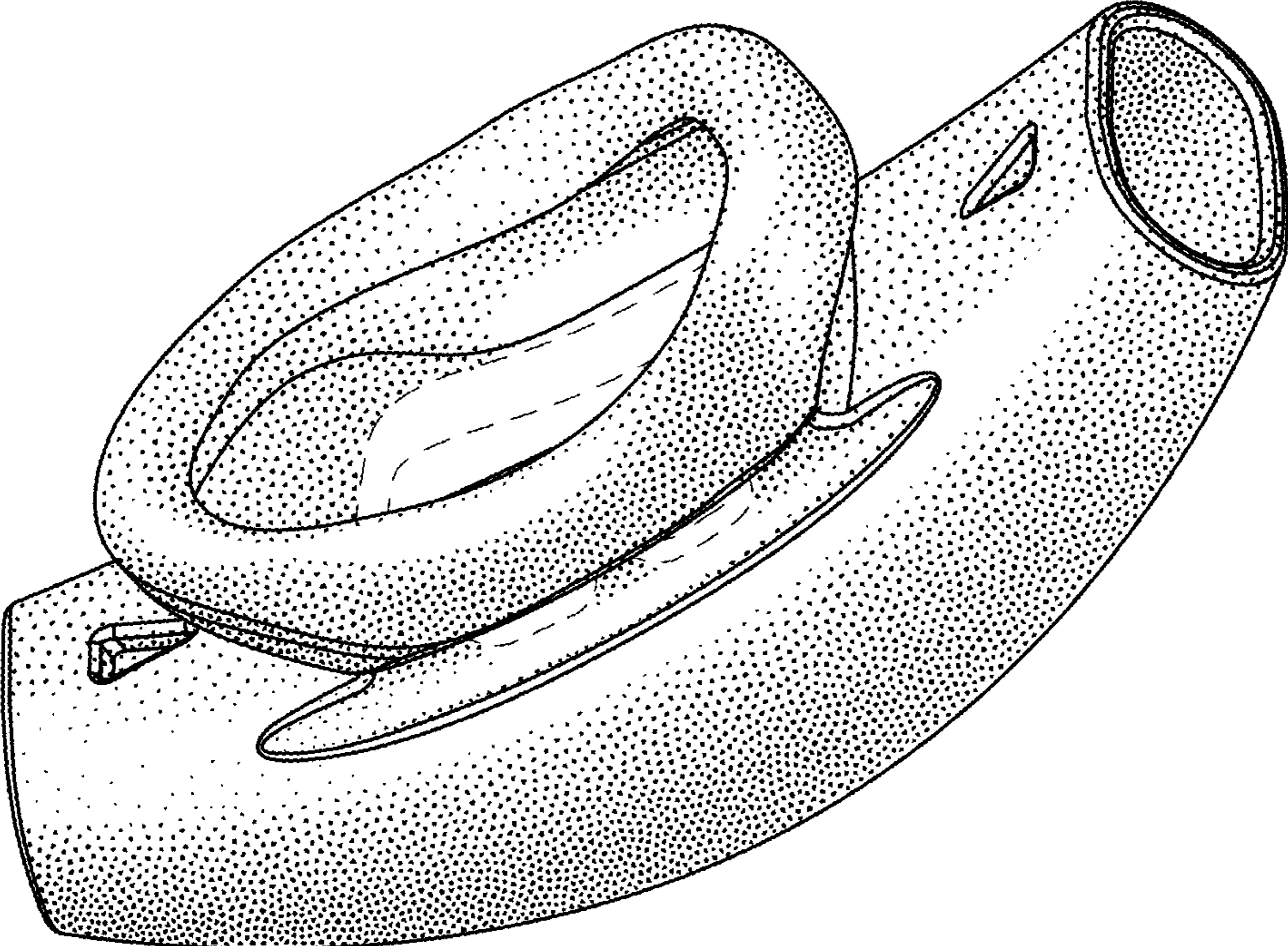

FIG. 8

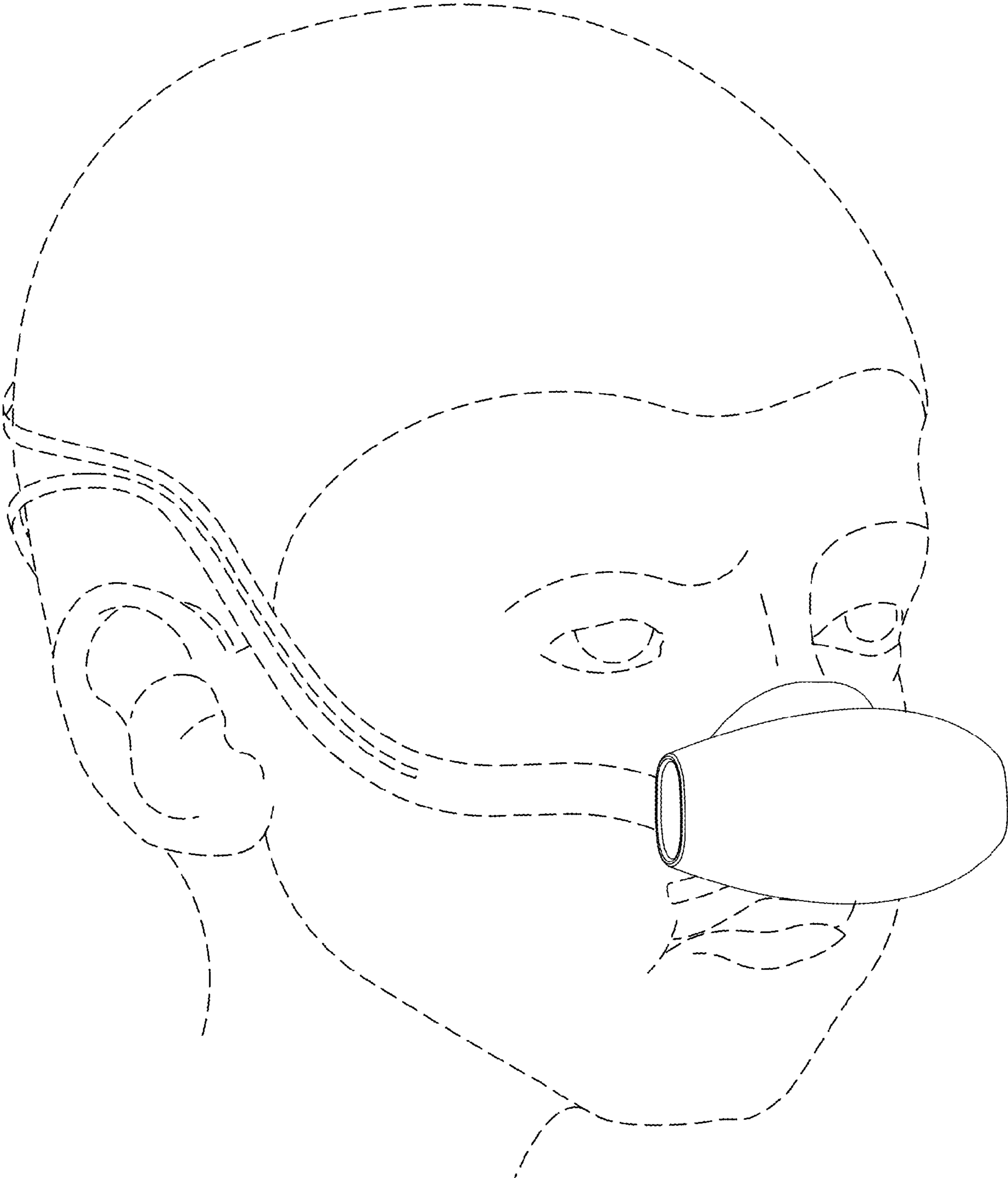

FIG. 9

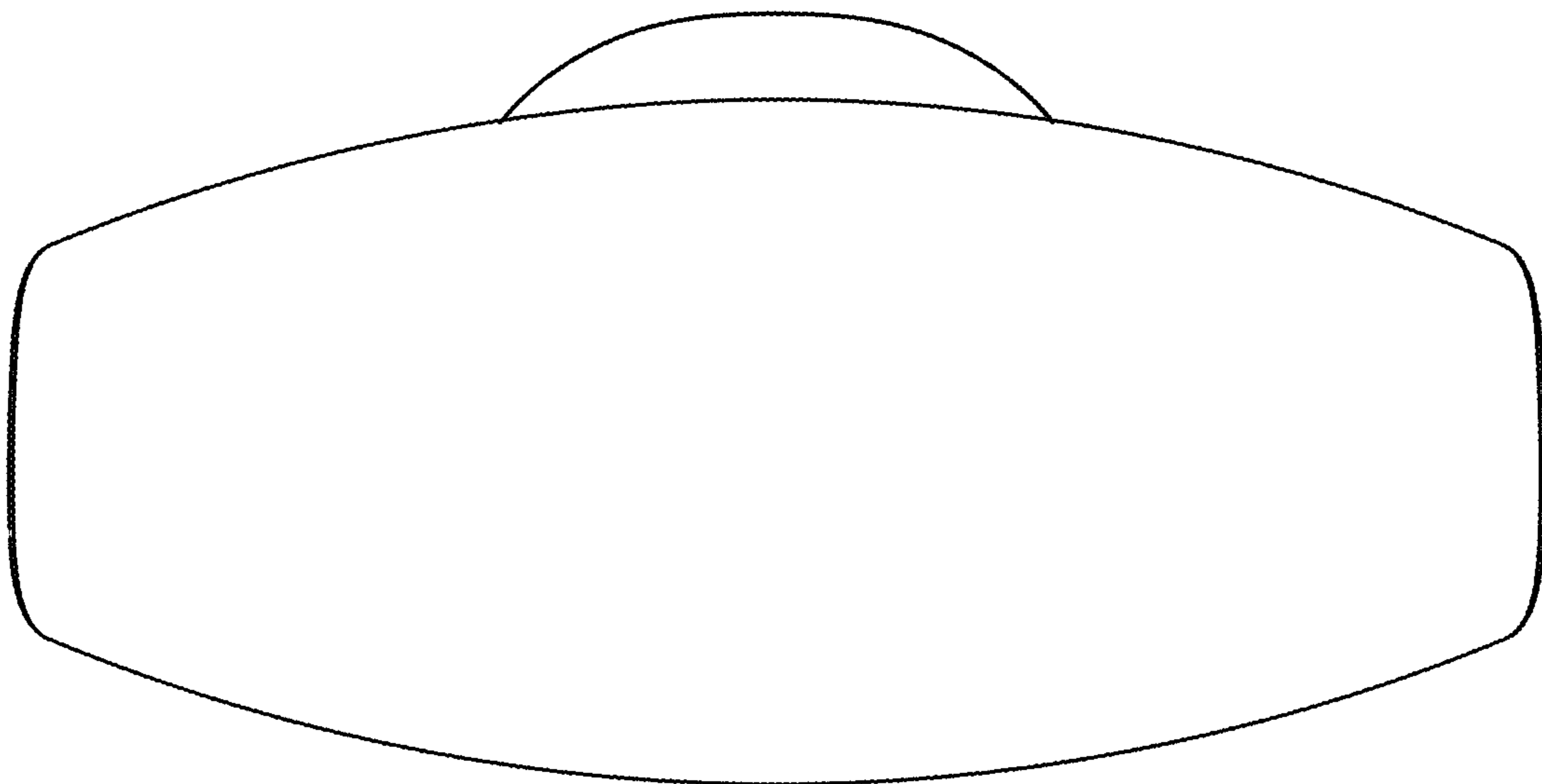

FIG. 10

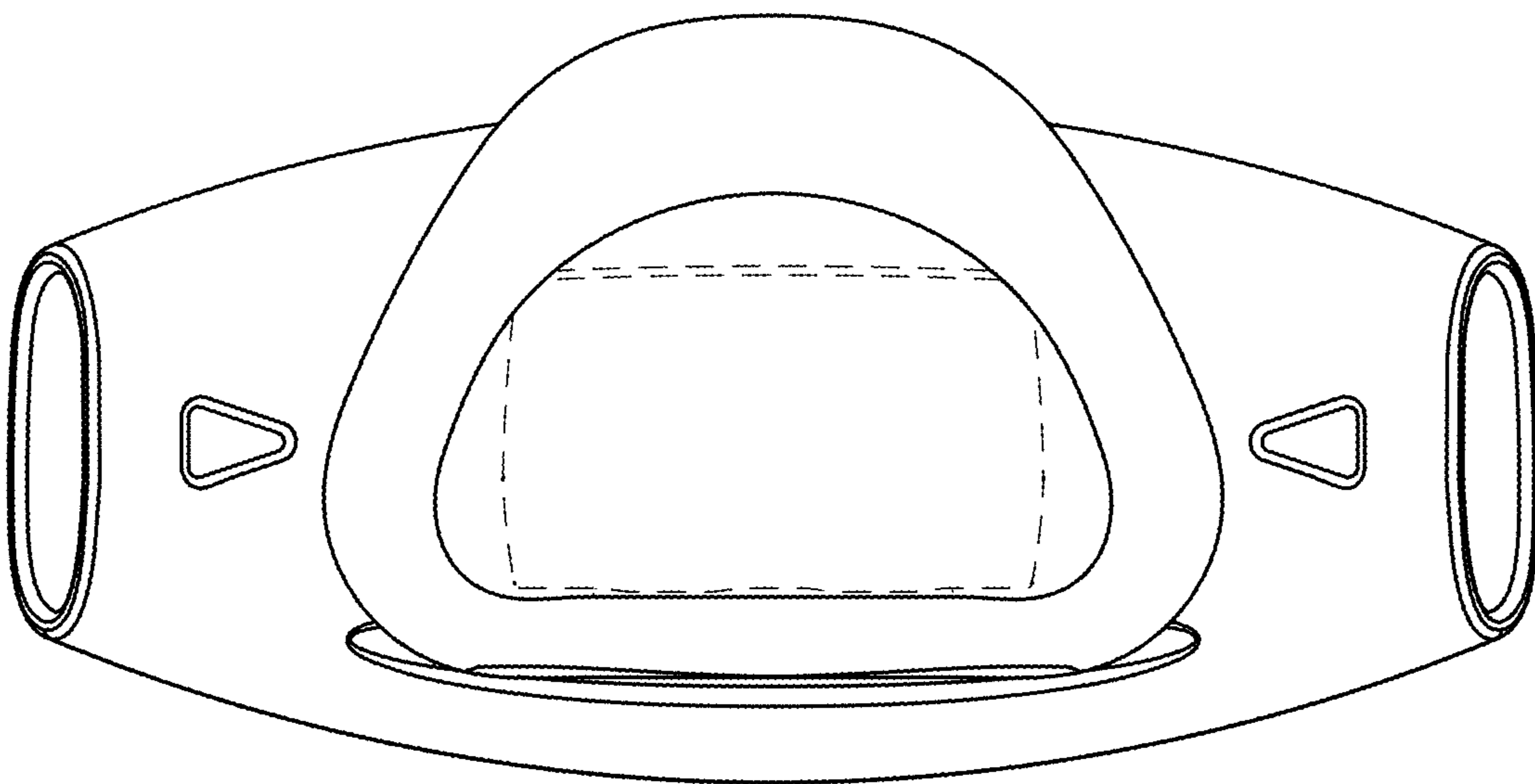

FIG. 11

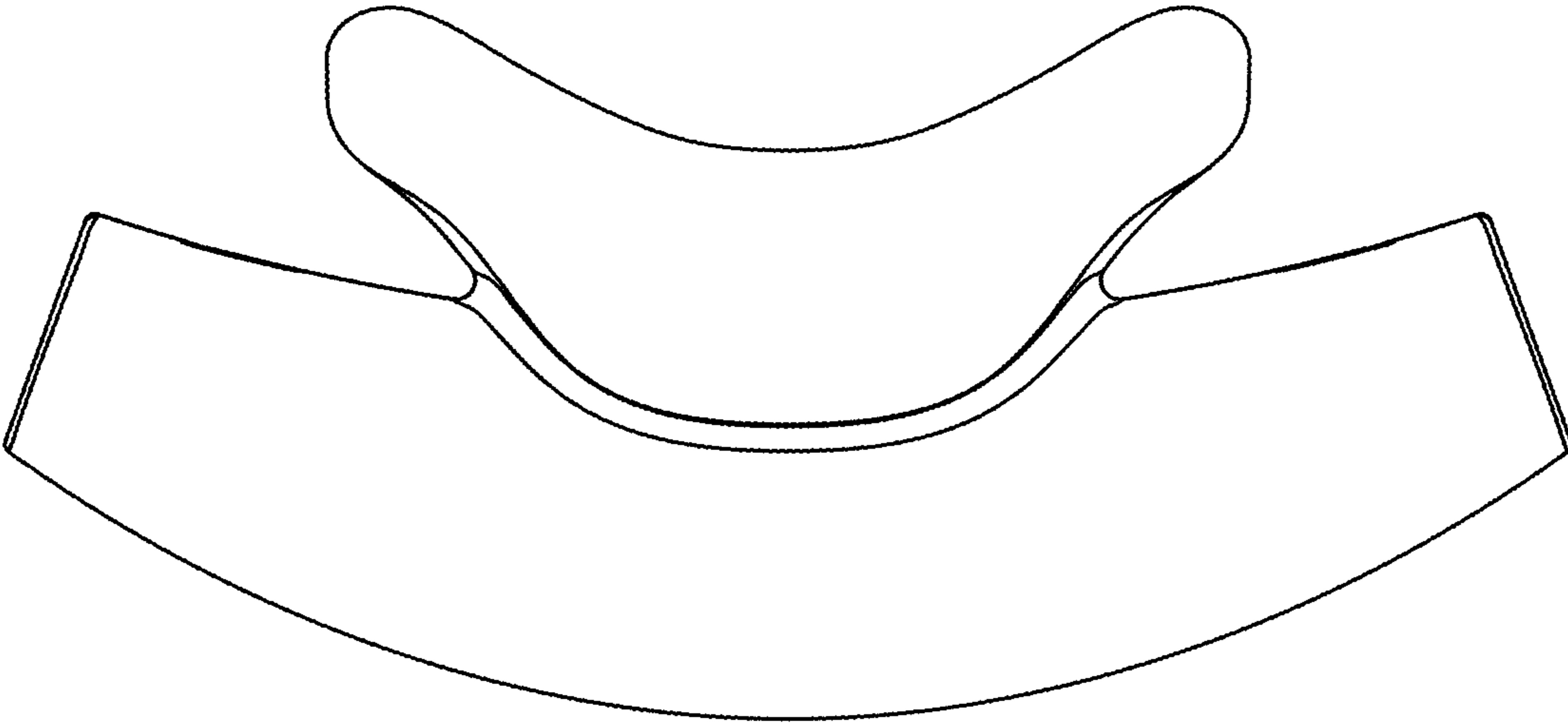

FIG. 12

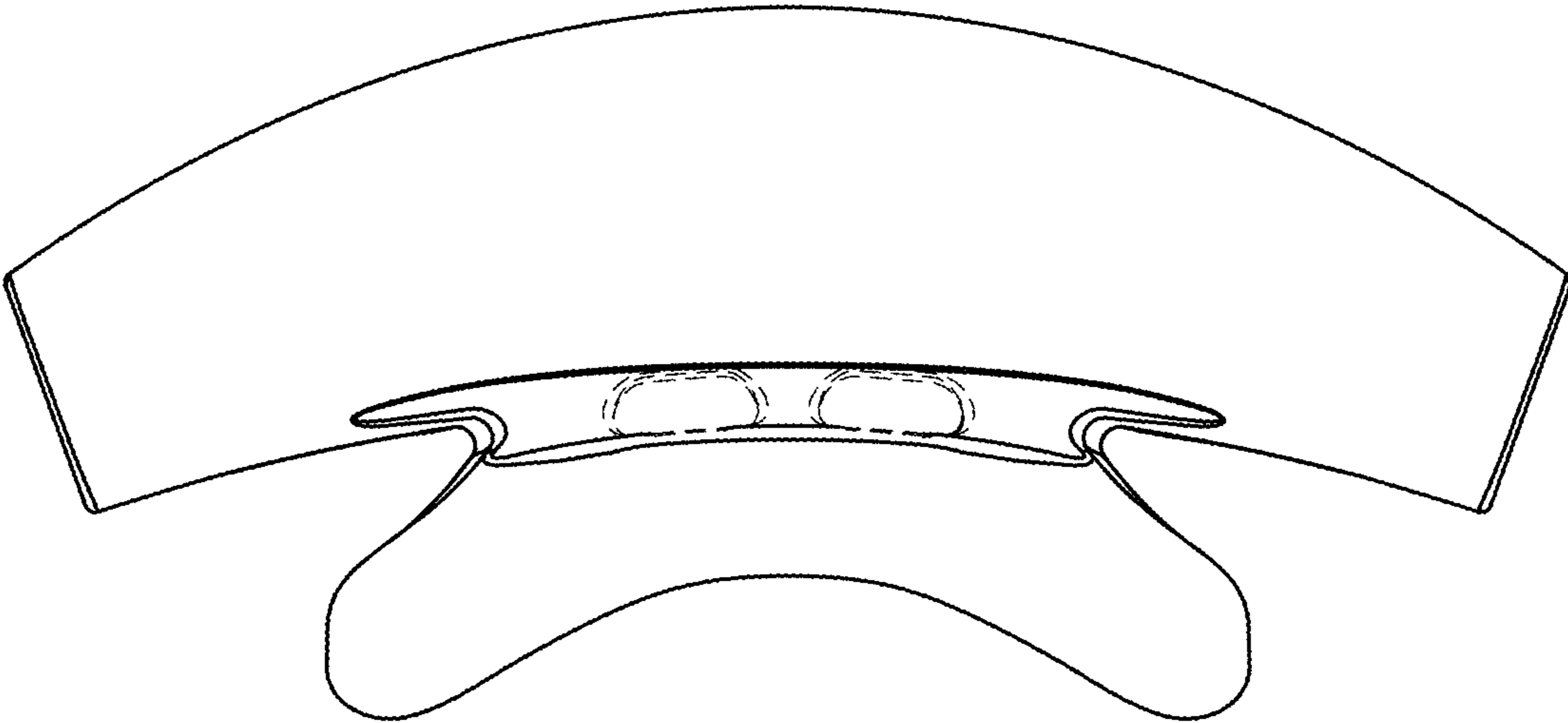

FIG. 13

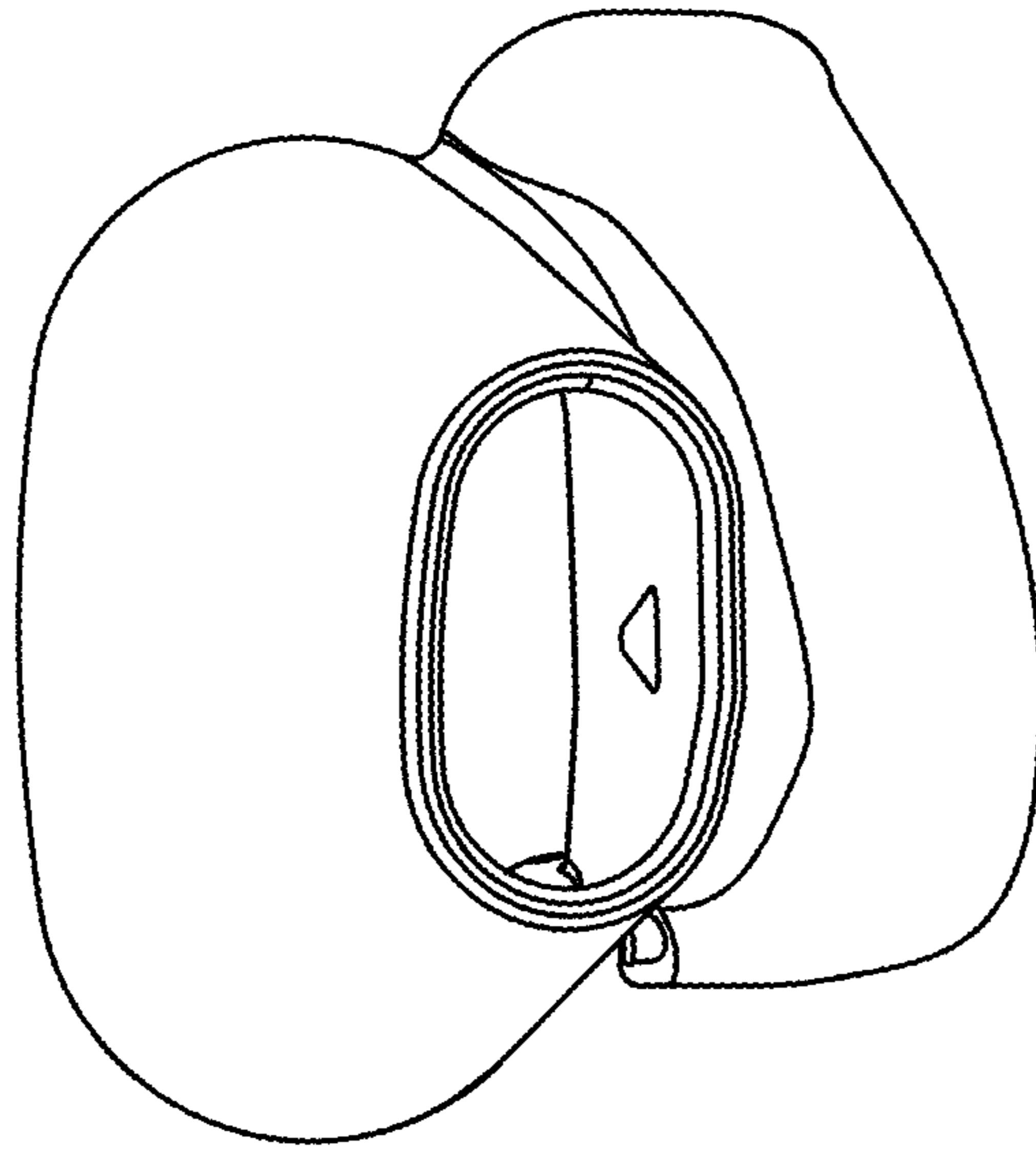

FIG. 14

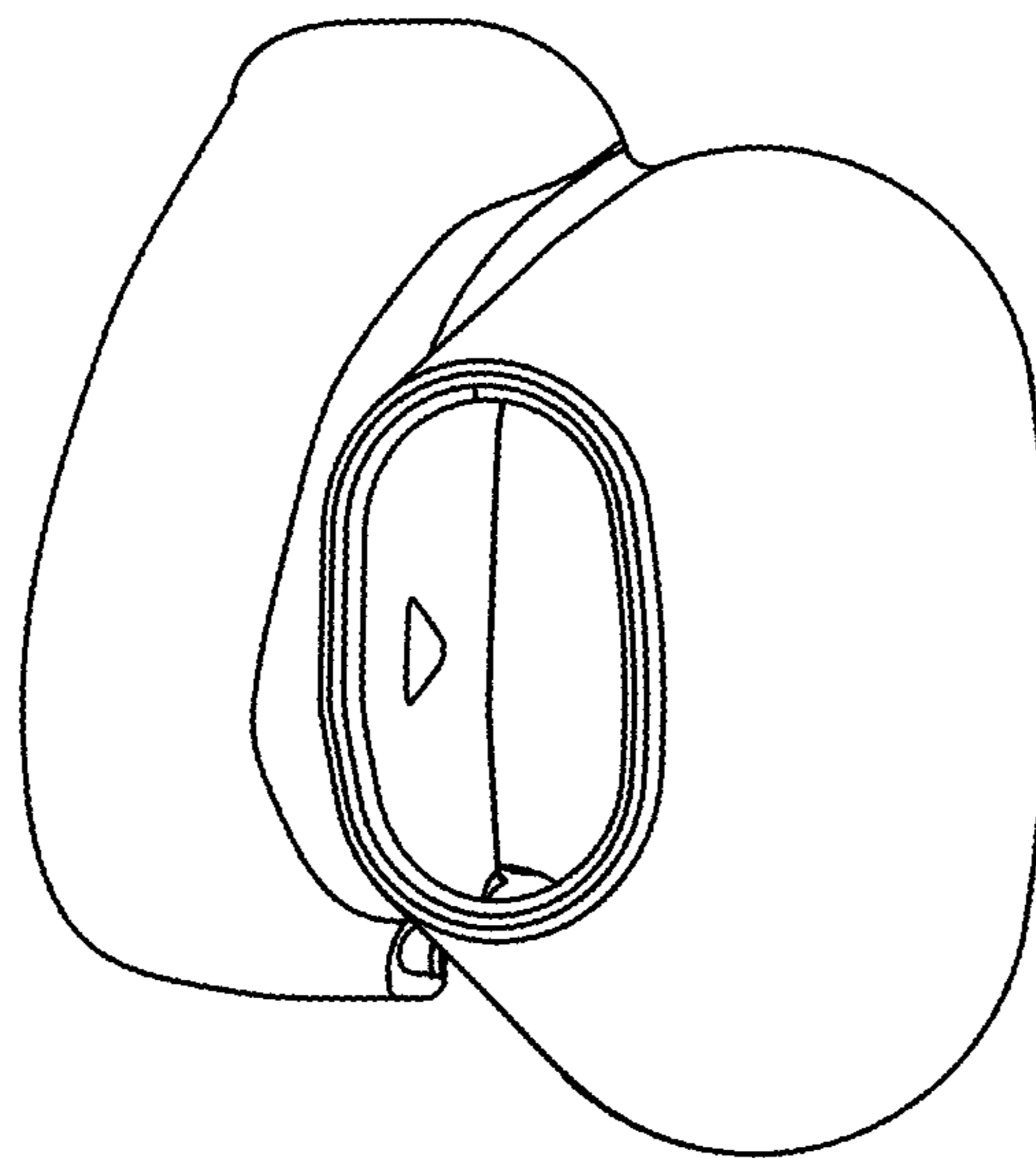

FIG. 15

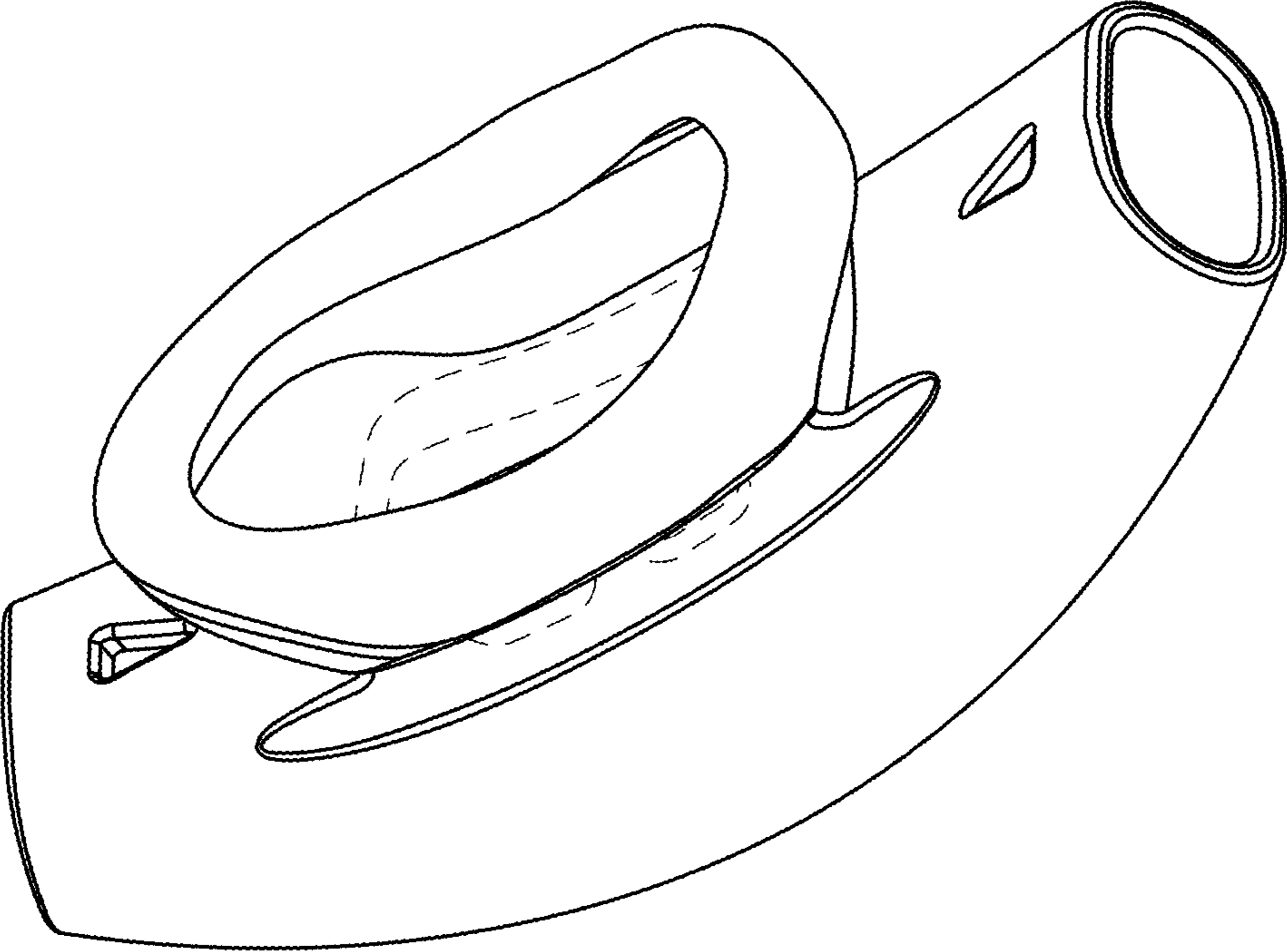

FIG.16