



US00D898872S

(12) **United States Design Patent**
Massaud

(10) **Patent No.:** **US D898,872 S**

(45) **Date of Patent:** **** Oct. 13, 2020**

(54) **FAUCET**

FOREIGN PATENT DOCUMENTS

(71) Applicant: **Hansgrohe SE**, Schiltach (DE)

CA 166280 * 1/2016

(72) Inventor: **Jean-Marie Massaud**, Paris (FR)

CN 302176652 11/2012

(73) Assignee: **Hansgrohe SE**, Schiltach (DE)

HK 1801084.7M001 6/2018

TR 201286-0006 * 1/2019

TR 201286-0007 * 1/2019

(**) Term: **15 Years**

OTHER PUBLICATIONS

(21) Appl. No.: **29/677,701**

Waterfall Faucet, Announced Aug. 23, 2018[online], [site visited Jun. 30, 2020]. Available from internet, URL:<<https://www.amazon.com/2-handle-Widespread-Bathroom-Waterfall-Lavatory-L4311LF-CH/dp/B07GRYQR45>> (Year: 2018).*

(22) Filed: **Jan. 23, 2019**

* cited by examiner

(30) **Foreign Application Priority Data**

Jul. 26, 2018 (EM) 005515749-0007

(51) **LOC (12) Cl.** **23-01**

Primary Examiner — Barbara Fox

(52) **U.S. Cl.**
USPC **D23/242**

Assistant Examiner — Jamaal Rasheed

(58) **Field of Classification Search**
USPC D23/238–242, 255; 137/896; 4/676
CPC F16K 11/087; E03C 1/04; C02F 1/00
See application file for complete search history.

(74) *Attorney, Agent, or Firm* — Lora J. Graentzdoerffer

(56) **References Cited**

(57) **CLAIM**

The ornamental design for a faucet, as shown and described.

U.S. PATENT DOCUMENTS

DESCRIPTION

D301,275 S *	5/1989	Paul	D23/242
D303,565 S *	9/1989	Paul	D23/242
D510,612 S *	10/2005	Lammel	D23/241
D625,393 S *	10/2010	Sieger	D23/242
D767,727 S *	9/2016	Eads	D23/242
D810,243 S *	2/2018	Schoenherr	D23/242
D811,536 S *	2/2018	Schoenherr	D23/242
D811,537 S *	2/2018	Schoenherr	D23/242
D828,506 S *	9/2018	Schoenherr	D23/238
D828,507 S *	9/2018	Schoenherr	D23/238
D856,490 S *	8/2019	Seum	D23/242
D861,136 S *	9/2019	Diefenbach	D23/242
D883,442 S *	5/2020	Massaud	D23/242

FIG. 1 is a perspective view of a faucet showing my design;
FIG. 2 is a front elevation view;
FIG. 3 is a rear elevation view;
FIG. 4 is a right side elevation view;
FIG. 5 is a left side elevation view;
FIG. 6 is a top plan view; and,
FIG. 7 is a bottom plan view.

The broken-line disclosures in the view represents portions of the faucet in which the claimed design is embodied, but which forms no part of the claimed design.

1 Claim, 7 Drawing Sheets

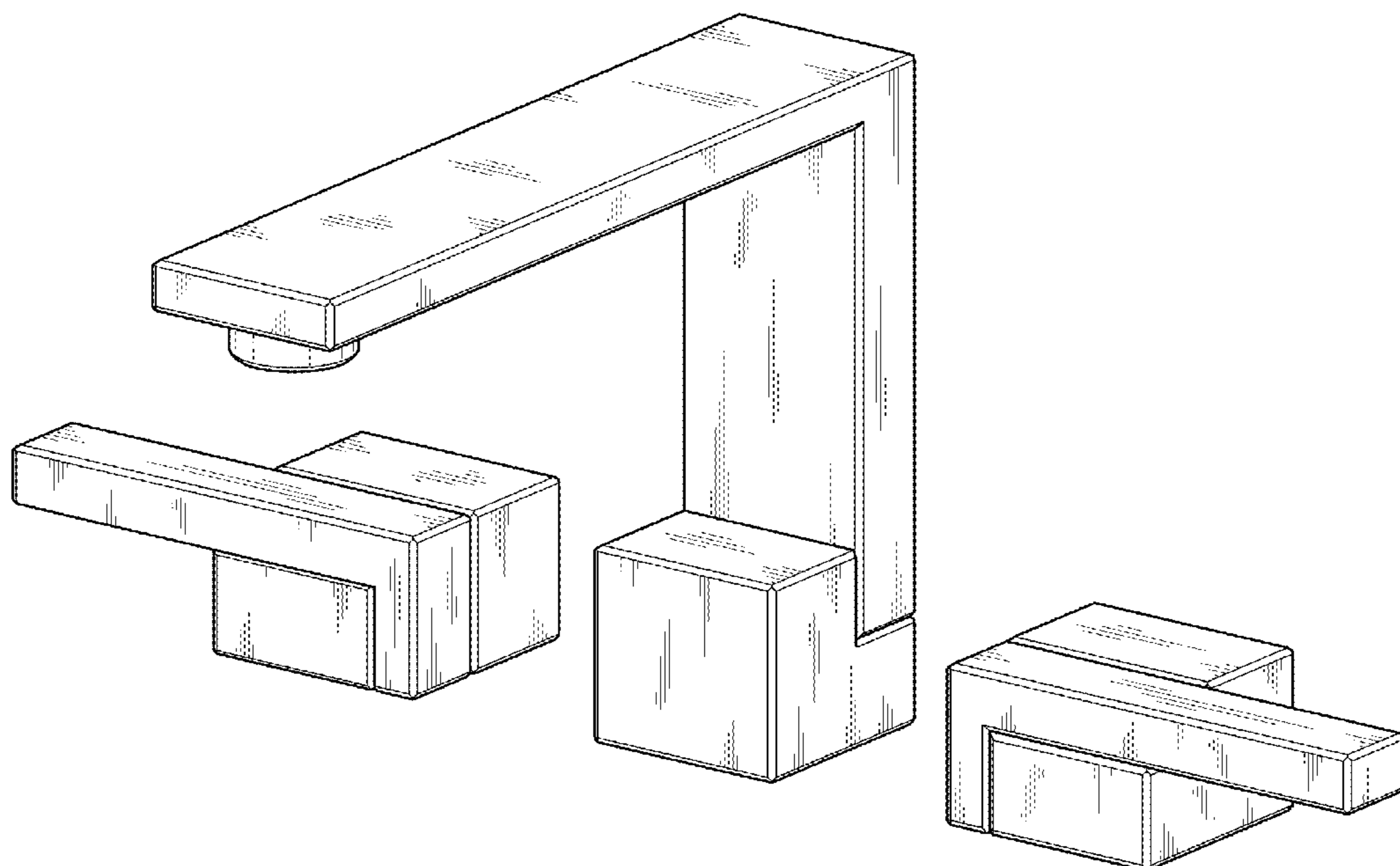

FIG. 1

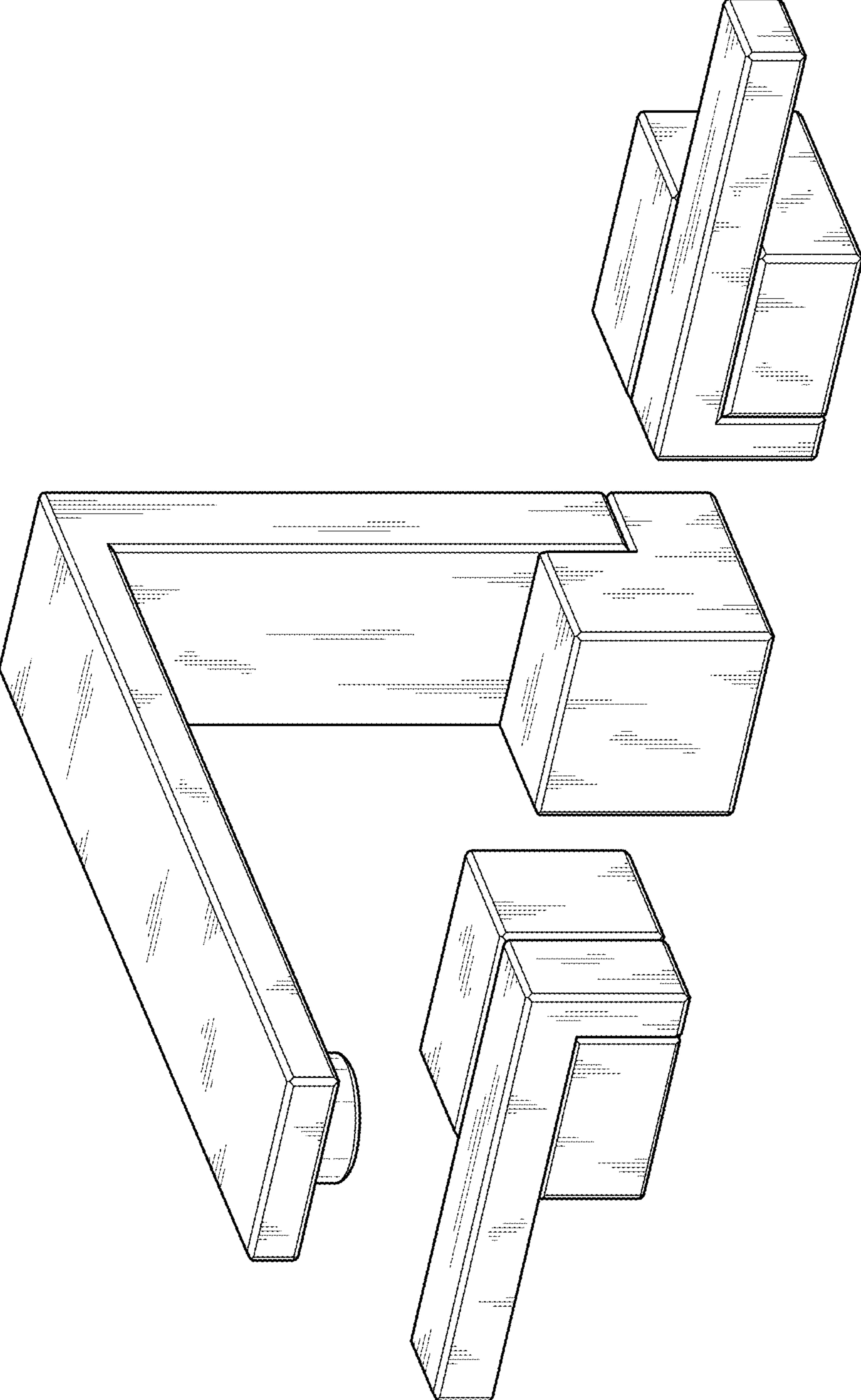

FIG. 2

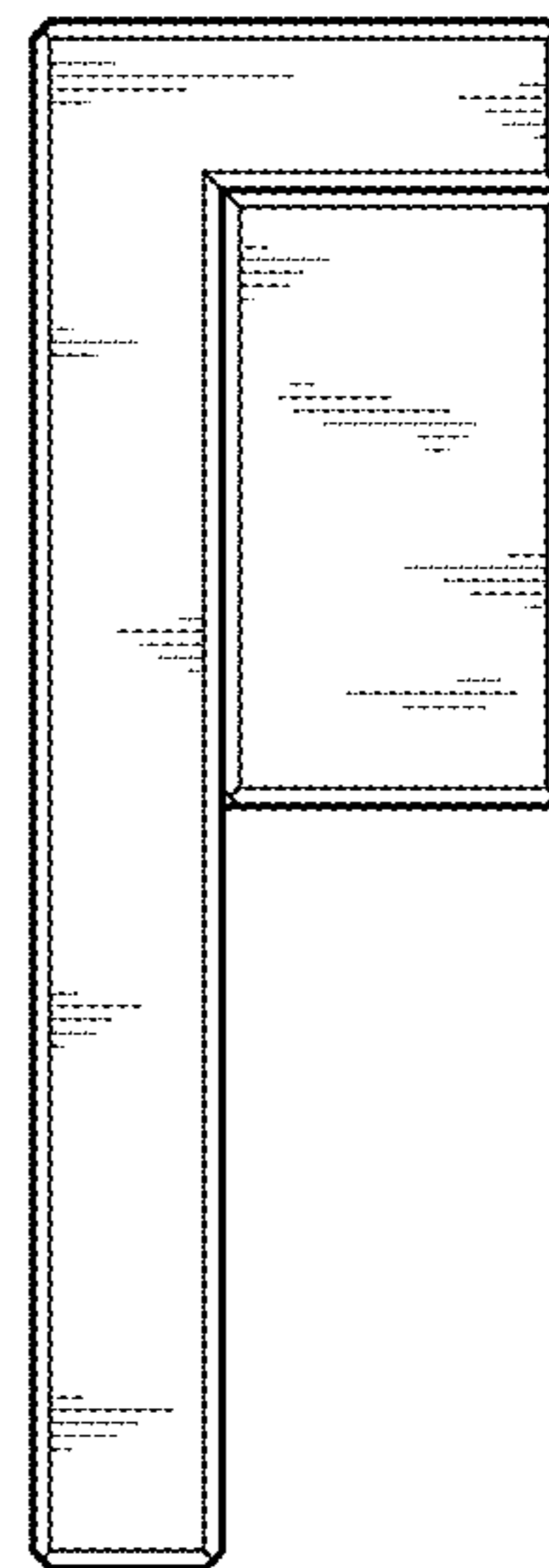
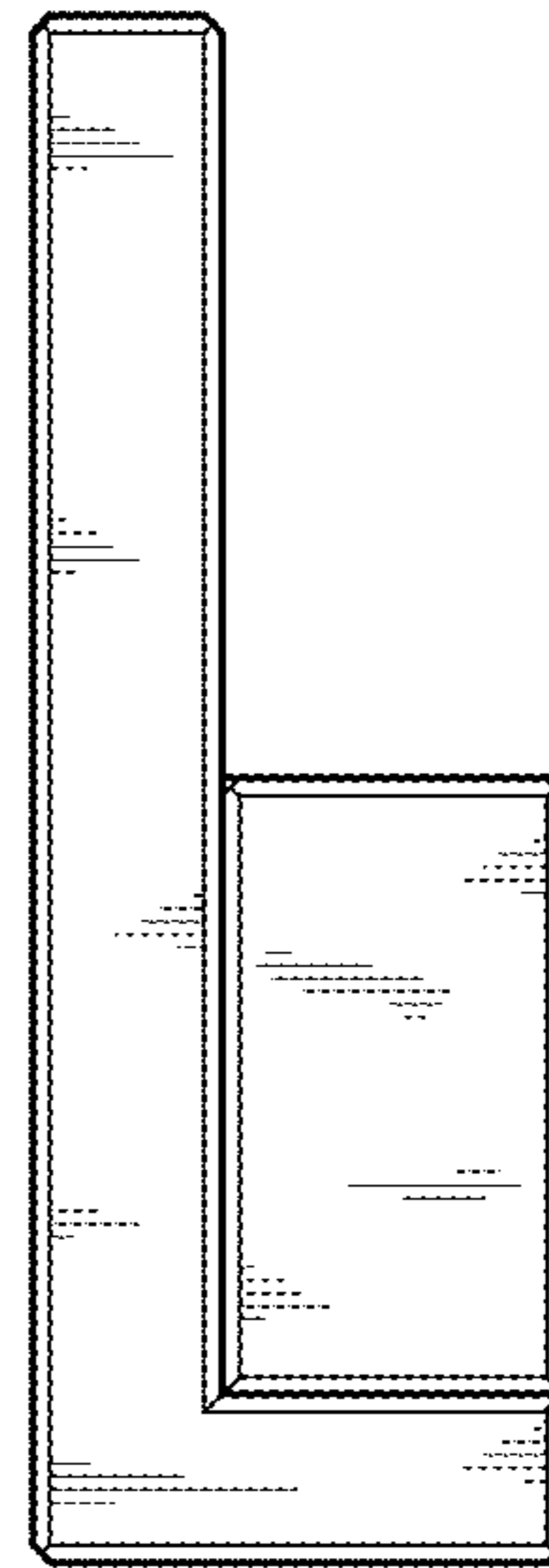
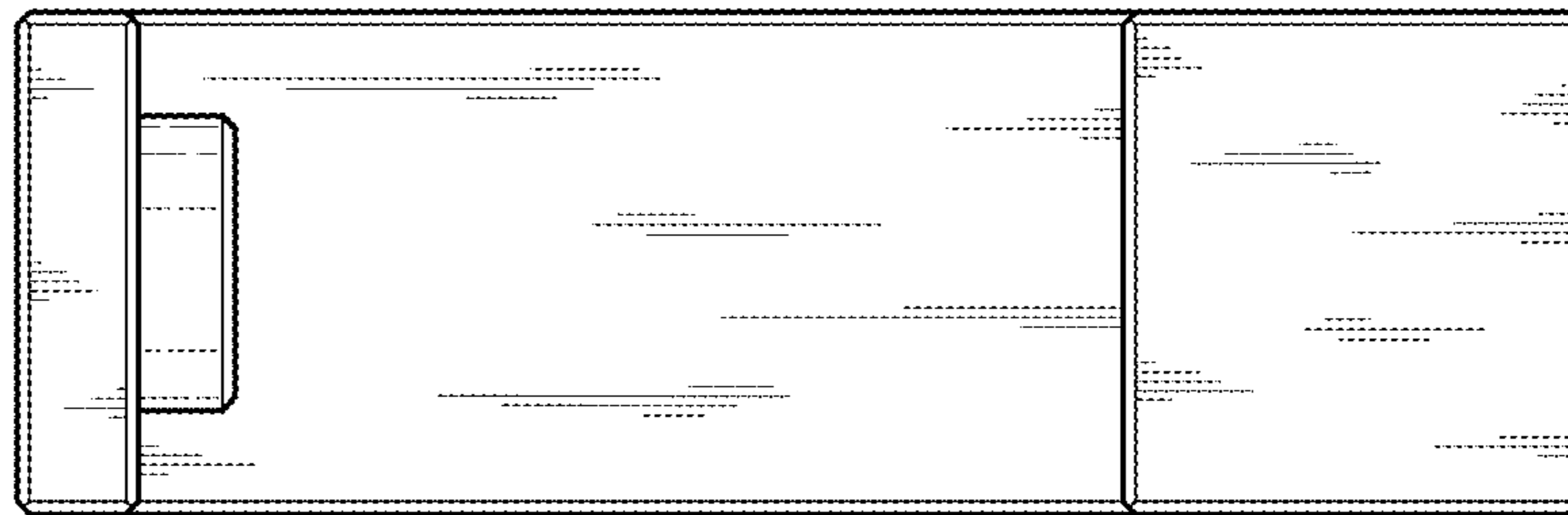

FIG. 3

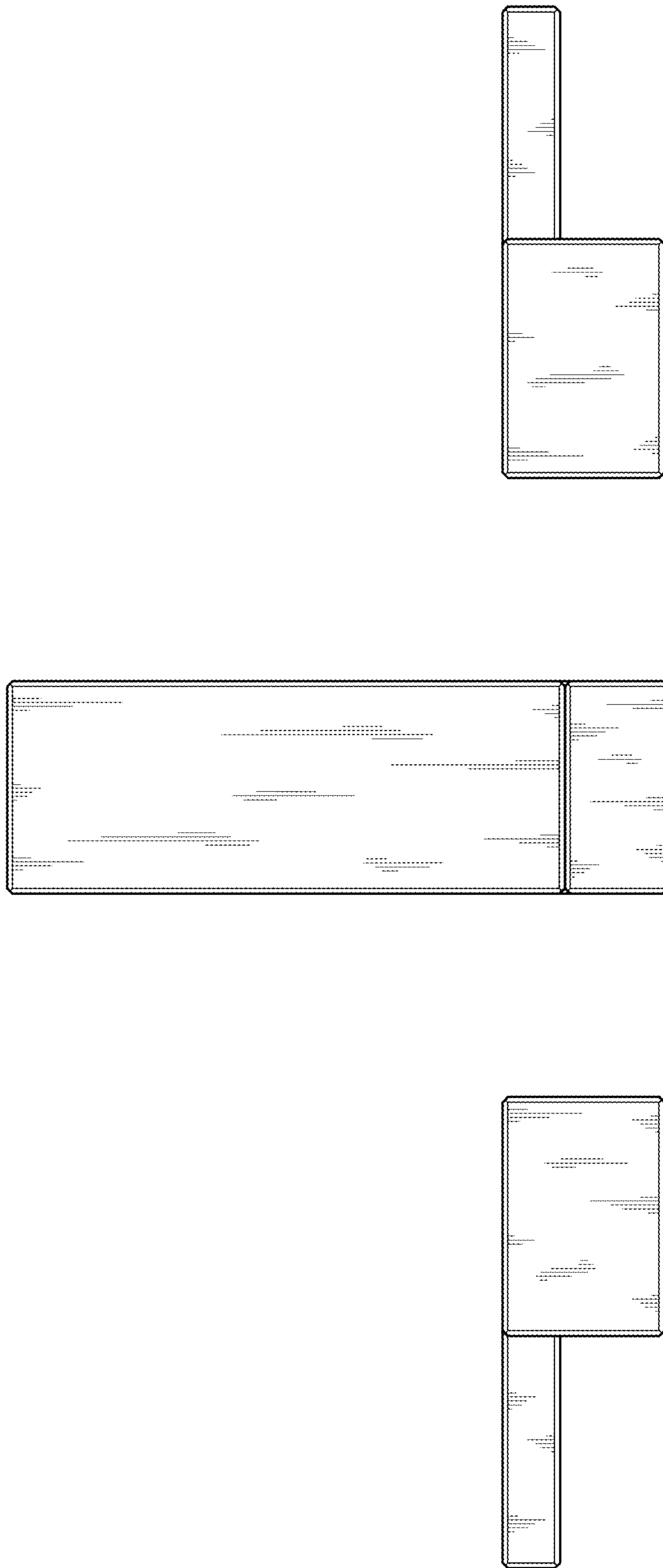

FIG. 4

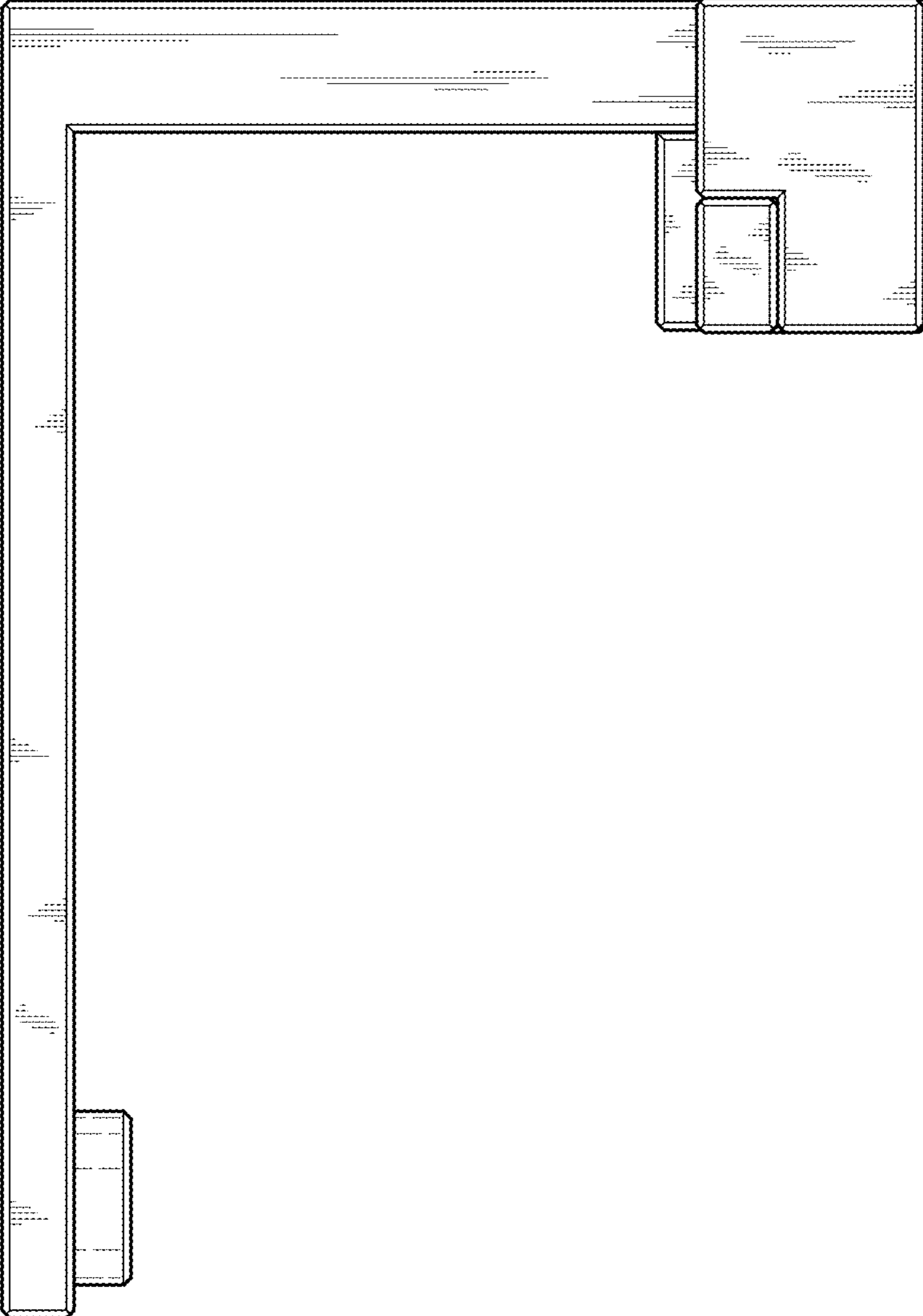
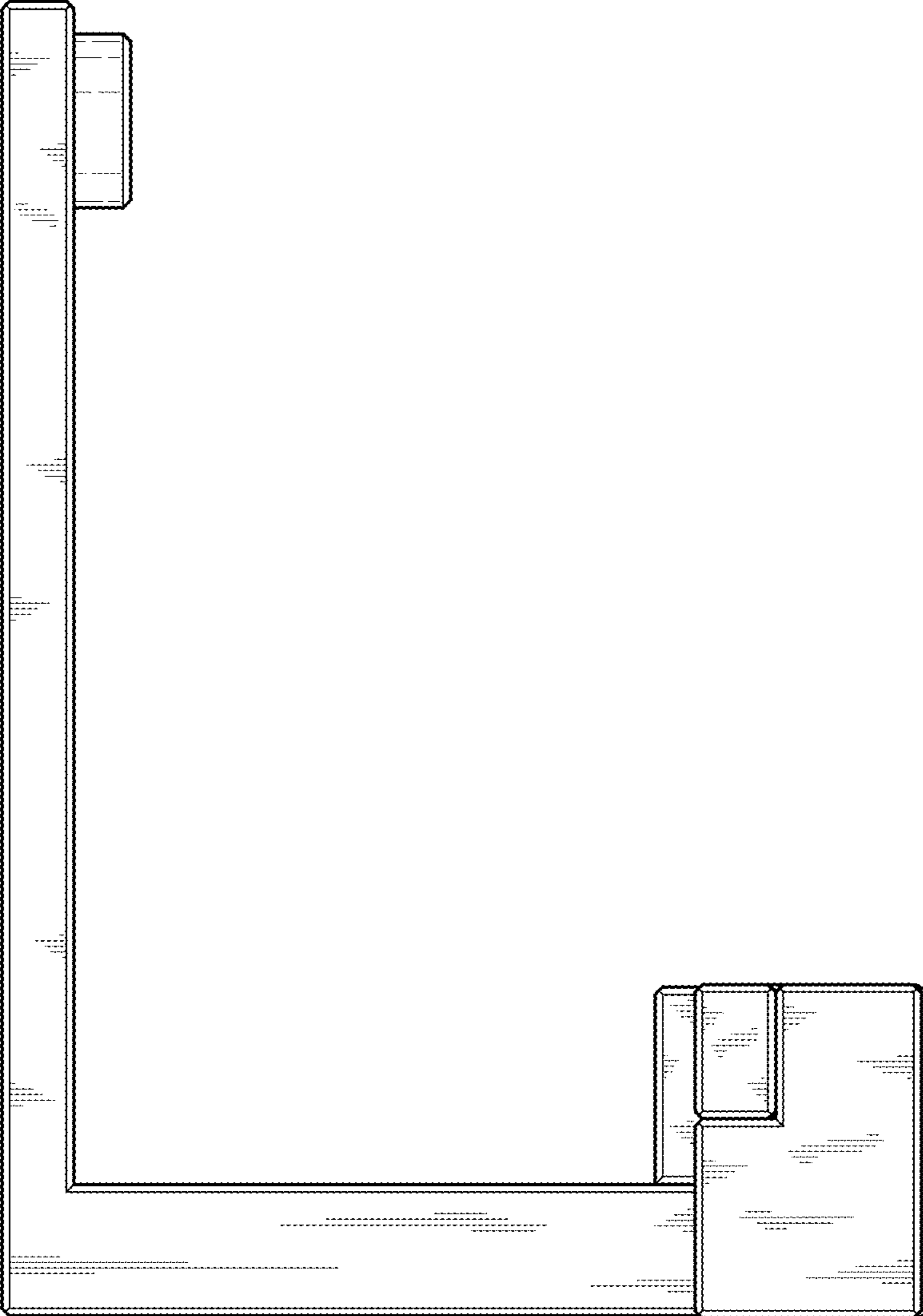

FIG. 5



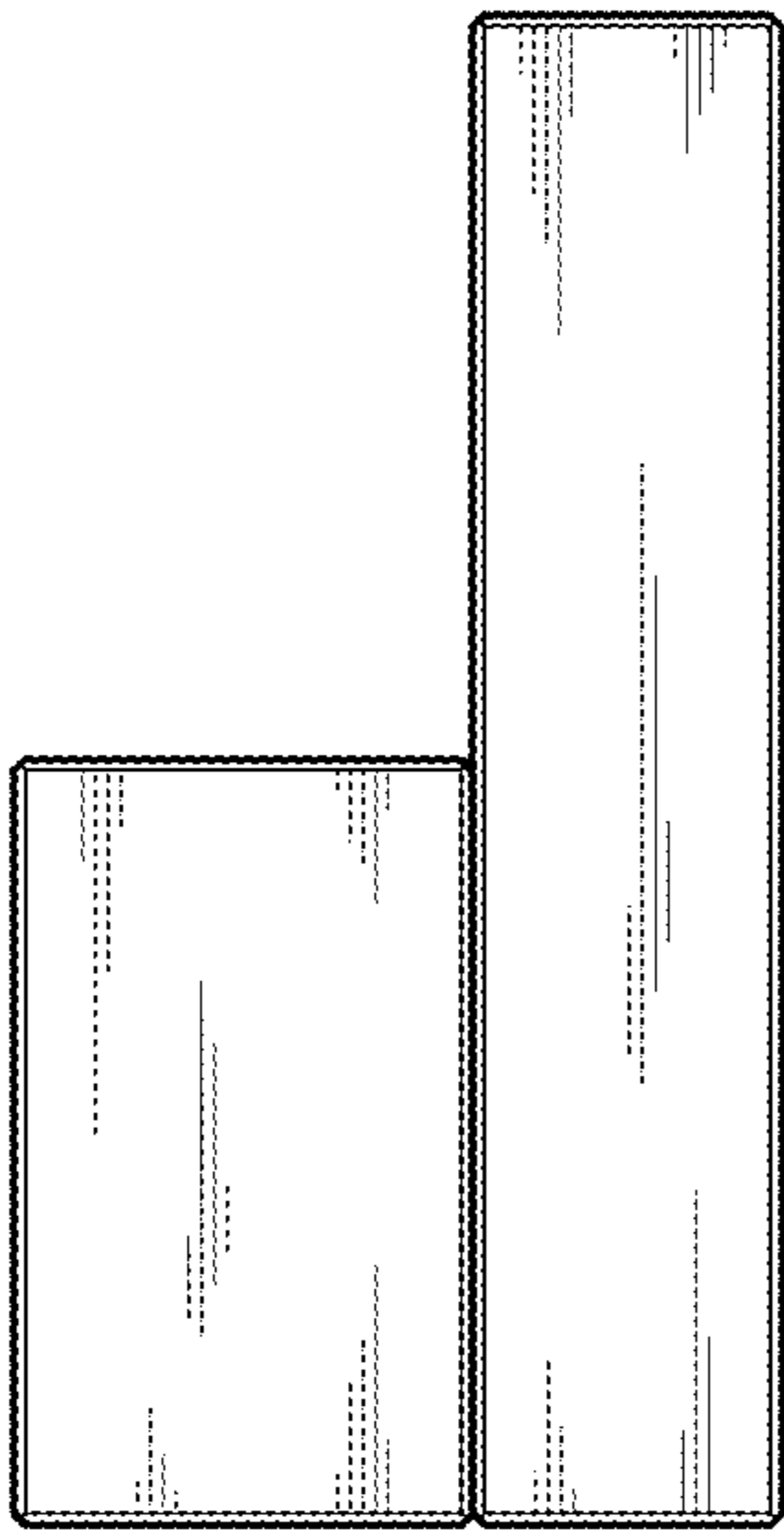

FIG. 6

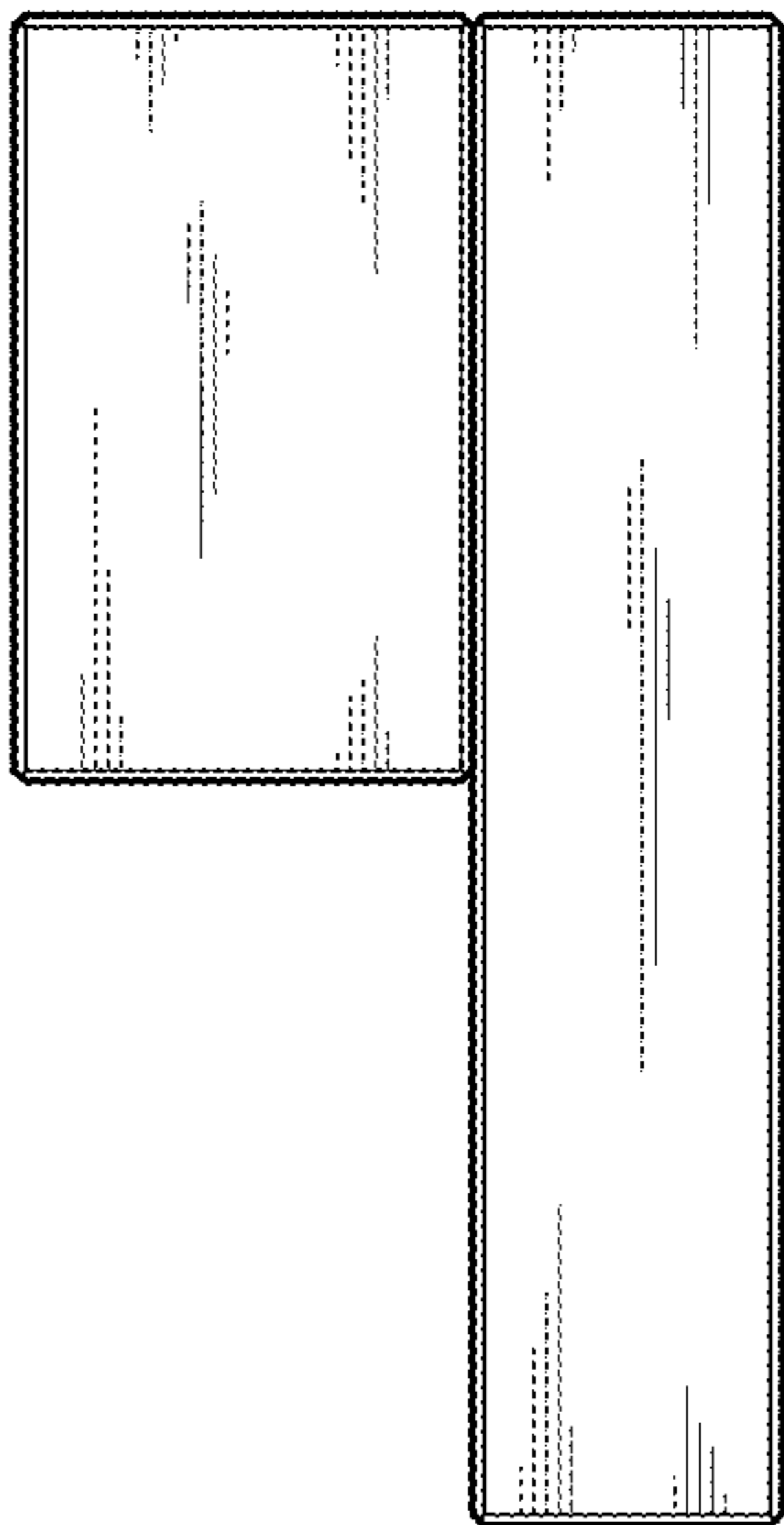
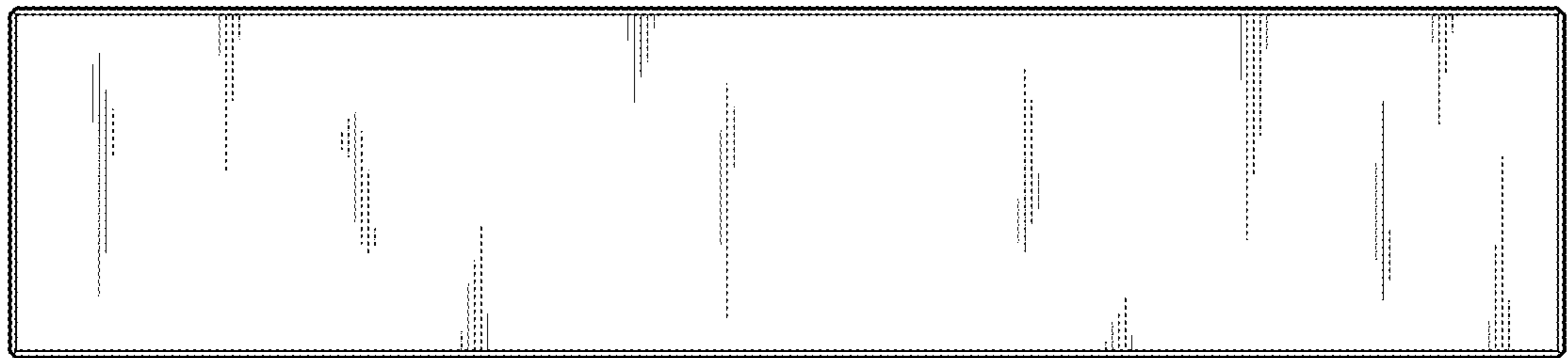

FIG. 7

