



US00D898823S

(12) **United States Design Patent**
Lusk

(10) **Patent No.:** **US D898,823 S**
(45) **Date of Patent:** **** Oct. 13, 2020**

(54) **CONVERTIBLE SPINE BOOK**

(71) Applicant: **Thomson Reuters Enterprise Centre GmbH, Zug (CH)**
(72) Inventor: **Linda Lusk, Fort Worth, TX (US)**
(73) Assignee: **THOMSON REUTERS ENTERPRISE CENTRE GMBH, Zug (CH)**
(**) Term: **15 Years**

(21) Appl. No.: **29/637,353**
(22) Filed: **Feb. 16, 2018**

Related U.S. Application Data

(63) Continuation-in-part of application No. 29/585,631, filed on Nov. 28, 2016, now Pat. No. Des. 811,476.
(51) **LOC (12) Cl.** **19-04**
(52) **U.S. Cl.**
USPC **D19/26**
(58) **Field of Classification Search**
USPC D19/26, 27, 28, 29, 30, 31, 32, 33, 34, D19/86, 90, 99, 100, 124, 2, 3, 65; D3/303, 227, 900; D9/433, 634
(Continued)

(56) **References Cited**

U.S. PATENT DOCUMENTS

529,614 A 11/1894 Frith
1,501,234 A * 7/1924 Rand B42F 19/00
40/359

(Continued)

FOREIGN PATENT DOCUMENTS

FR 1118294 A * 6/1956 B42F 11/00
FR 2261141 A1 * 9/1975 B42F 13/0006

(Continued)

OTHER PUBLICATIONS

Etsy Link: <https://www.etsy.com/listing/94307165/midsize-expandable-travel-journal-smash>. Apr. 24, 2018. Midsize Expandable Travel Journal, Smash Book or Art Journal with Custom Map, Pockets and Envelopes, Scrapbook, Notebook. (Year: 2018).*

(Continued)

Primary Examiner — Susan Bennett Hattan
Assistant Examiner — Lauren D McVey

(74) *Attorney, Agent, or Firm* — Thomson Reuters

(57) **CLAIM**

The ornamental design for a convertible spine book, as shown and described.

DESCRIPTION

FIG. 1 is a perspective view of a convertible spine book, showing my design in a first state;
FIG. 2 is a front elevational view thereof;
FIG. 3 is a rear elevational view thereof;
FIG. 4 is a right side elevational view thereof;
FIG. 5 is a left side elevational view thereof;
FIG. 6 is a top view thereof;
FIG. 7 is a second perspective view of the convertible spine book in a second state;
FIG. 8 is a front elevational view thereof;
FIG. 9 is a rear elevational view thereof;
FIG. 10 is a right side elevational view thereof;
FIG. 11 is a left side elevational view thereof;
FIG. 12 is a top view thereof; and,
FIG. 13 is a plan view of the design in a pre-folded state. The broken lines immediately adjacent the shaded areas represent the bounds of the claimed design while all other broken lines are directed to environment; the broken lines form no part of the claimed design.

1 Claim, 11 Drawing Sheets

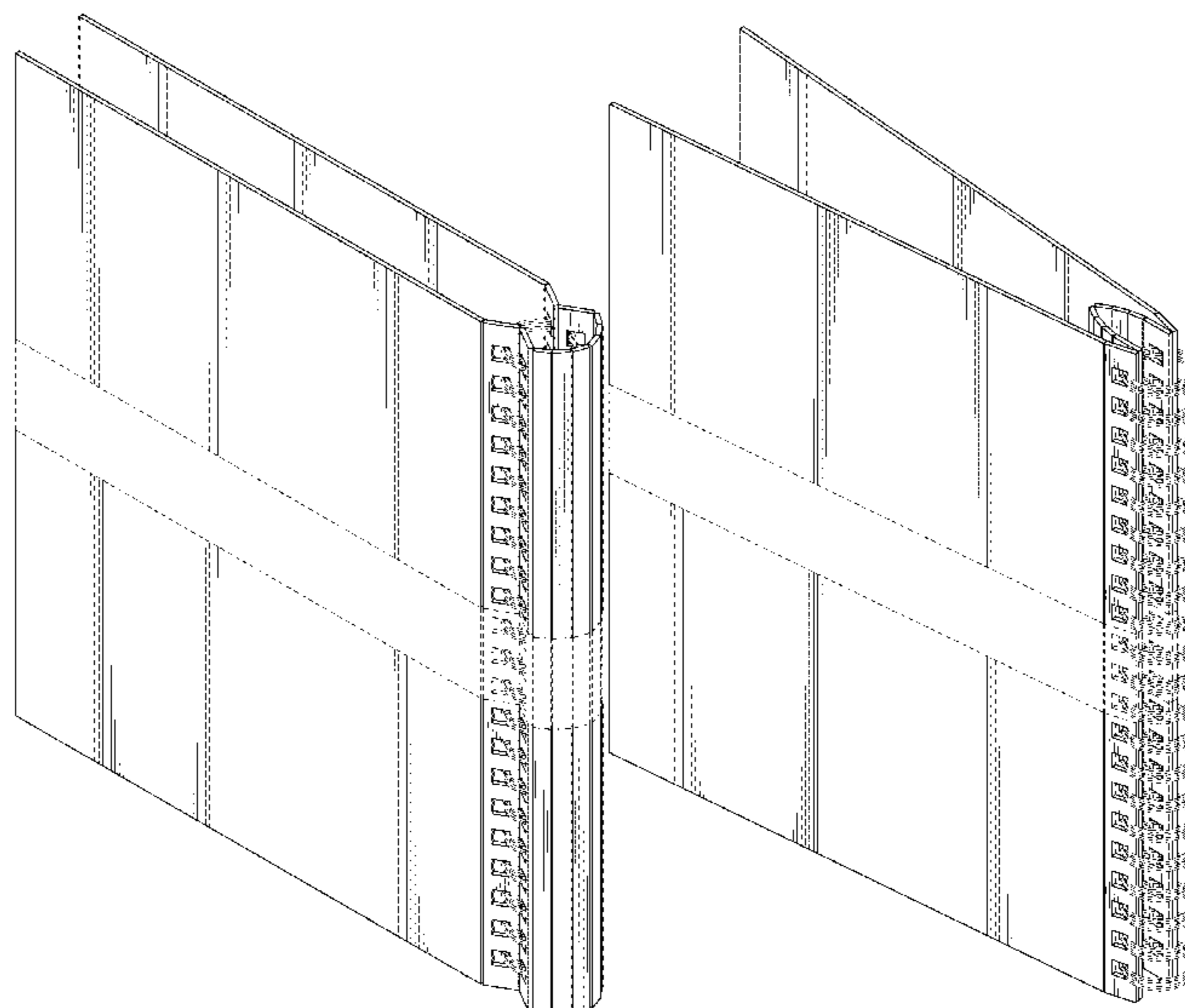

(58) **Field of Classification Search**

CPC B42F 13/16; B42F 13/165; B42F 13/18;
 B42F 13/20; B42F 13/22; B42F 13/24;
 B42F 13/26; B42F 13/28; B42F 13/30;
 B42F 13/32; B42F 13/34; B42F 13/36;
 B42F 13/38; B42F 13/40; B42F 13/0006;
 B42F 13/0013; B42F 13/002

See application file for complete search history.

(56) **References Cited**

U.S. PATENT DOCUMENTS

2,322,177 A * 6/1943 Trussell B42F 13/0066
 402/21
 3,212,505 A 10/1965 Toman
 3,572,957 A 3/1971 Strassberg
 4,114,240 A 9/1978 Nackenson
 4,711,469 A * 12/1987 Bogar B42B 5/08
 281/15.1
 4,811,973 A 3/1989 Kumar-Misir
 D302,699 S 8/1989 Popat et al.
 4,880,327 A * 11/1989 Sanabria A47B 23/043
 402/73
 D328,096 S 7/1992 Gordon
 5,417,510 A 5/1995 Stout
 D382,899 S 8/1997 Le Blan et al.
 5,683,111 A 11/1997 Bass et al.
 5,697,646 A 12/1997 Venegas
 D399,525 S 10/1998 Parker
 5,944,353 A * 8/1999 Sato B42F 9/008
 281/15.1
 D413,923 S 9/1999 Brown et al.
 6,004,060 A * 12/1999 Bedol B42D 5/042
 281/38
 6,010,157 A * 1/2000 Pierson B42D 3/002
 281/15.1

D457,558 S * 5/2002 Barlow D19/27
 6,386,784 B1 * 5/2002 Ruble B42F 13/0073
 24/67 R
 6,412,819 B1 7/2002 Paine et al.
 D463,487 S 9/2002 Savoy
 D524,862 S 7/2006 Arceneaux
 D560,718 S 1/2008 King et al.
 D565,098 S 3/2008 Lesperance, Jr.
 D569,903 S * 5/2008 Bharma D19/26
 D586,389 S 2/2009 Schaaf
 D586,852 S 2/2009 Porcano et al.
 D601,187 S 9/2009 Davis et al.
 D656,543 S 3/2012 Upshaw
 D695,341 S 12/2013 Noskin
 D730,047 S 5/2015 Yi
 D731,591 S 6/2015 Panigel
 D735,269 S 7/2015 Alford
 9,683,714 B1 * 6/2017 Gunawan F21V 3/049
 D811,476 S * 2/2018 Lusk D19/26

FOREIGN PATENT DOCUMENTS

FR 2542262 A1 * 9/1984 B42F 3/02
 FR 2581353 A1 * 11/1986 B42F 7/04
 FR 2628684 A1 9/1989
 GB 2318763 A * 5/1998 B42F 13/0006

OTHER PUBLICATIONS

JetPens. Link: <https://www.jetpens.com/Kokuyo-Novita-Alpha-Expandable-Clear-Book-A4-Light-Green/pd/11562>. Mar. 2, 2015. Kokuyo Novita Alpha Expandable Clear Book—A4—Light Green. (Year: 2015).
 Needles 'n' knowledge. <URL:<http://needlesnknowledge.blogspot.com/2014/08/3d-book-box-gift-card-holder-tutorial.html>> Aug. 3, 2014. Book-like box with articulated inner spine strips.

* cited by examiner

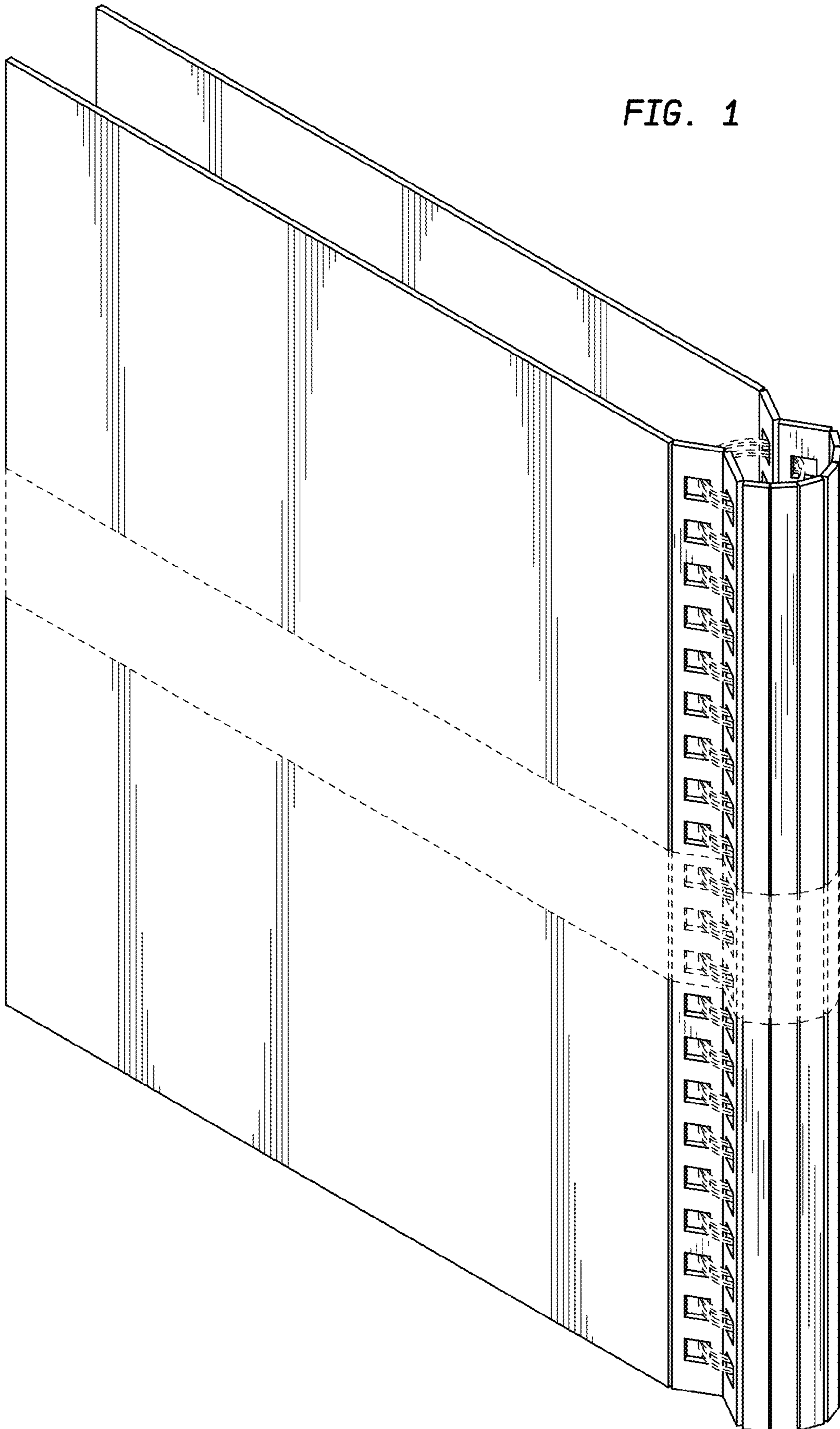

FIG. 2

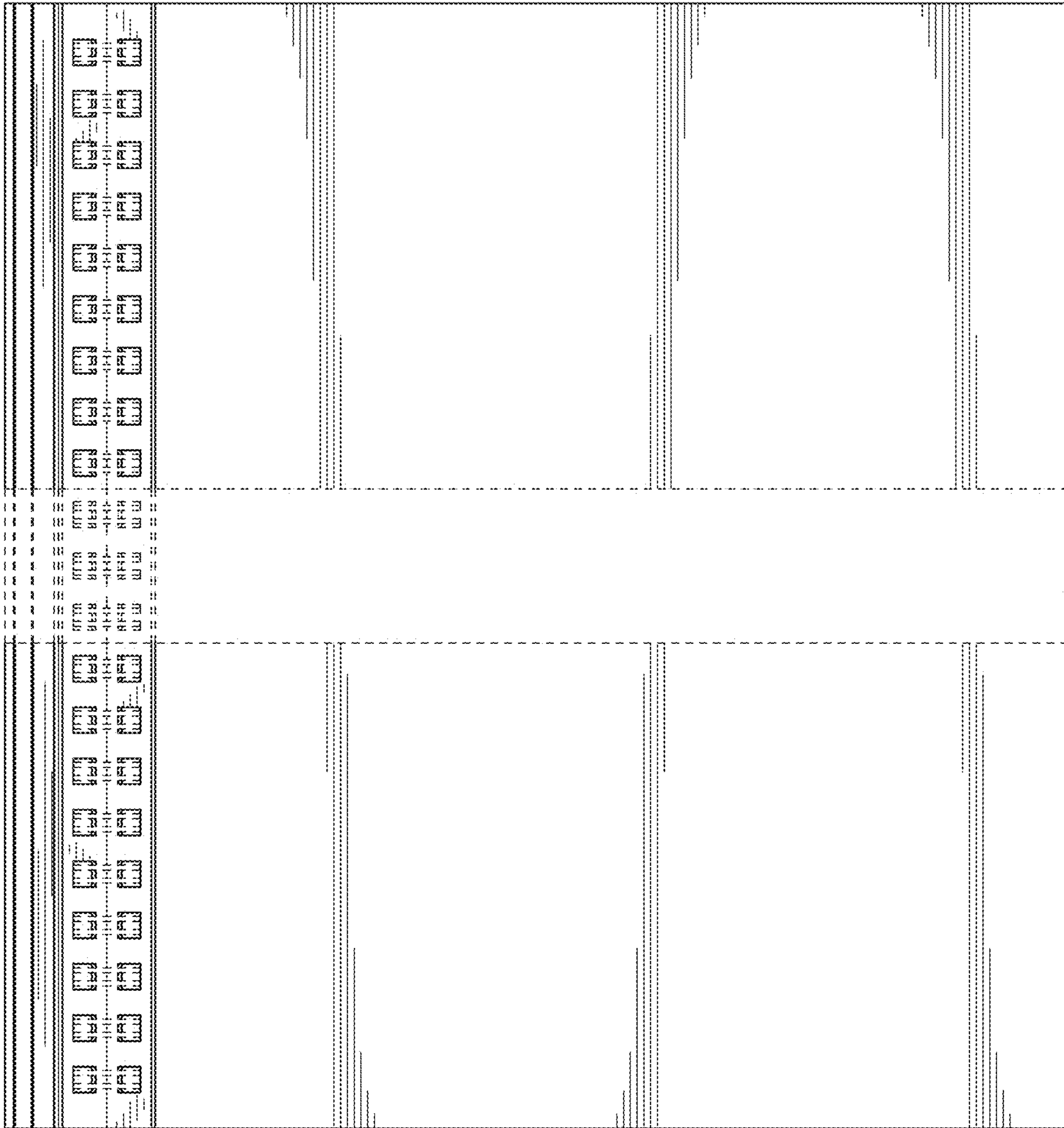

FIG. 3

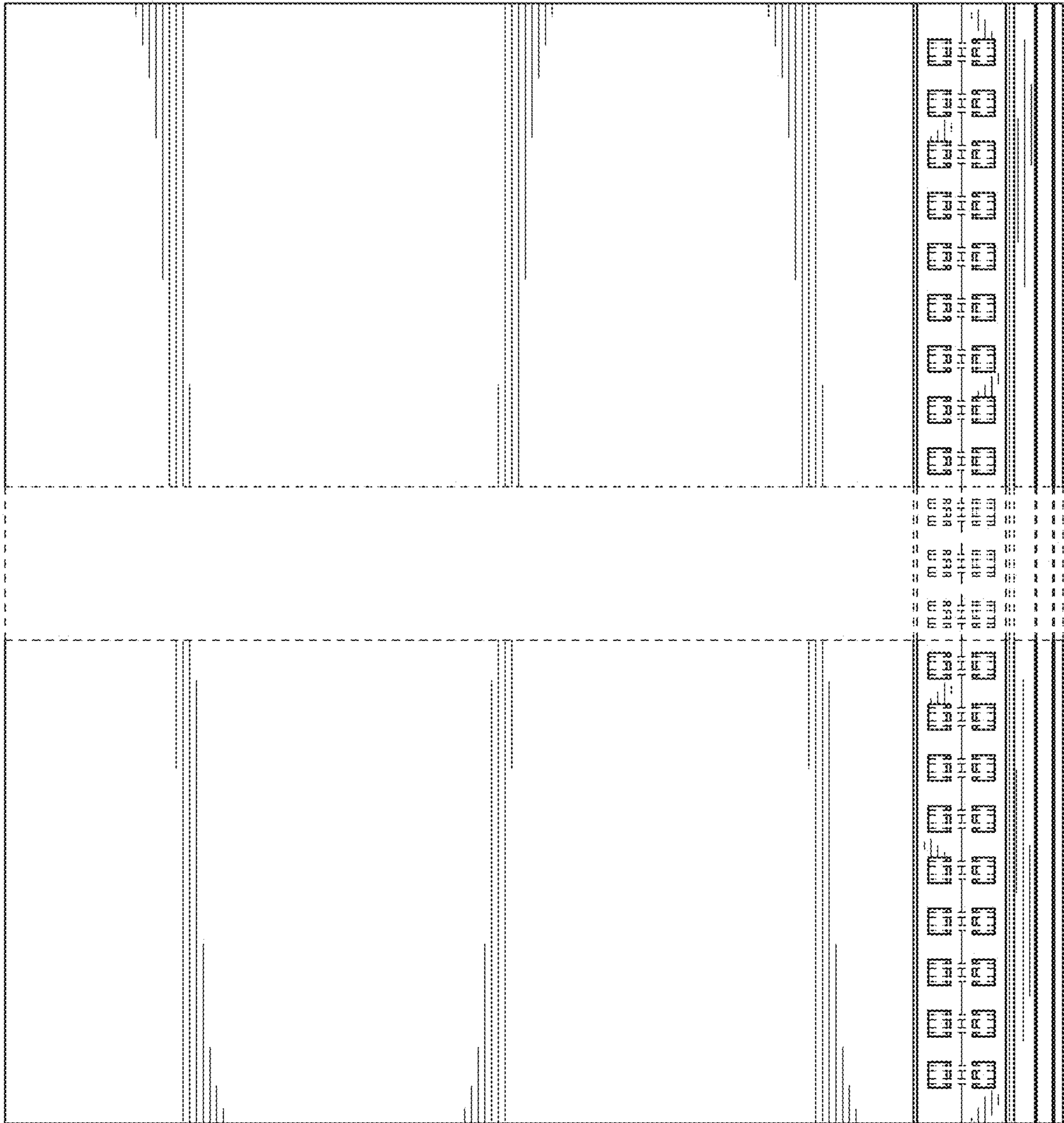

FIG. 4

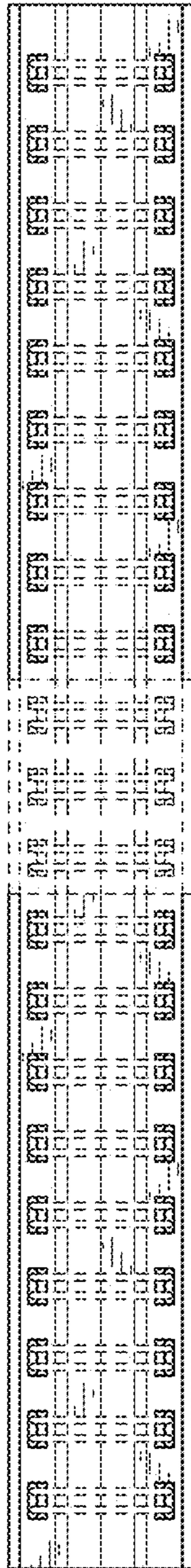

FIG. 5

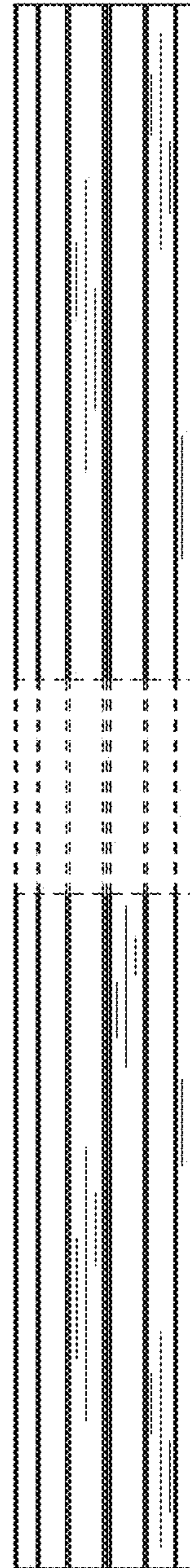

FIG. 6

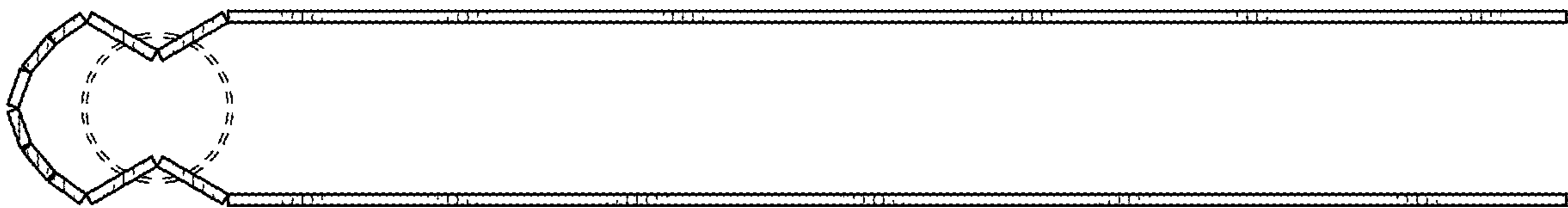

FIG. 7

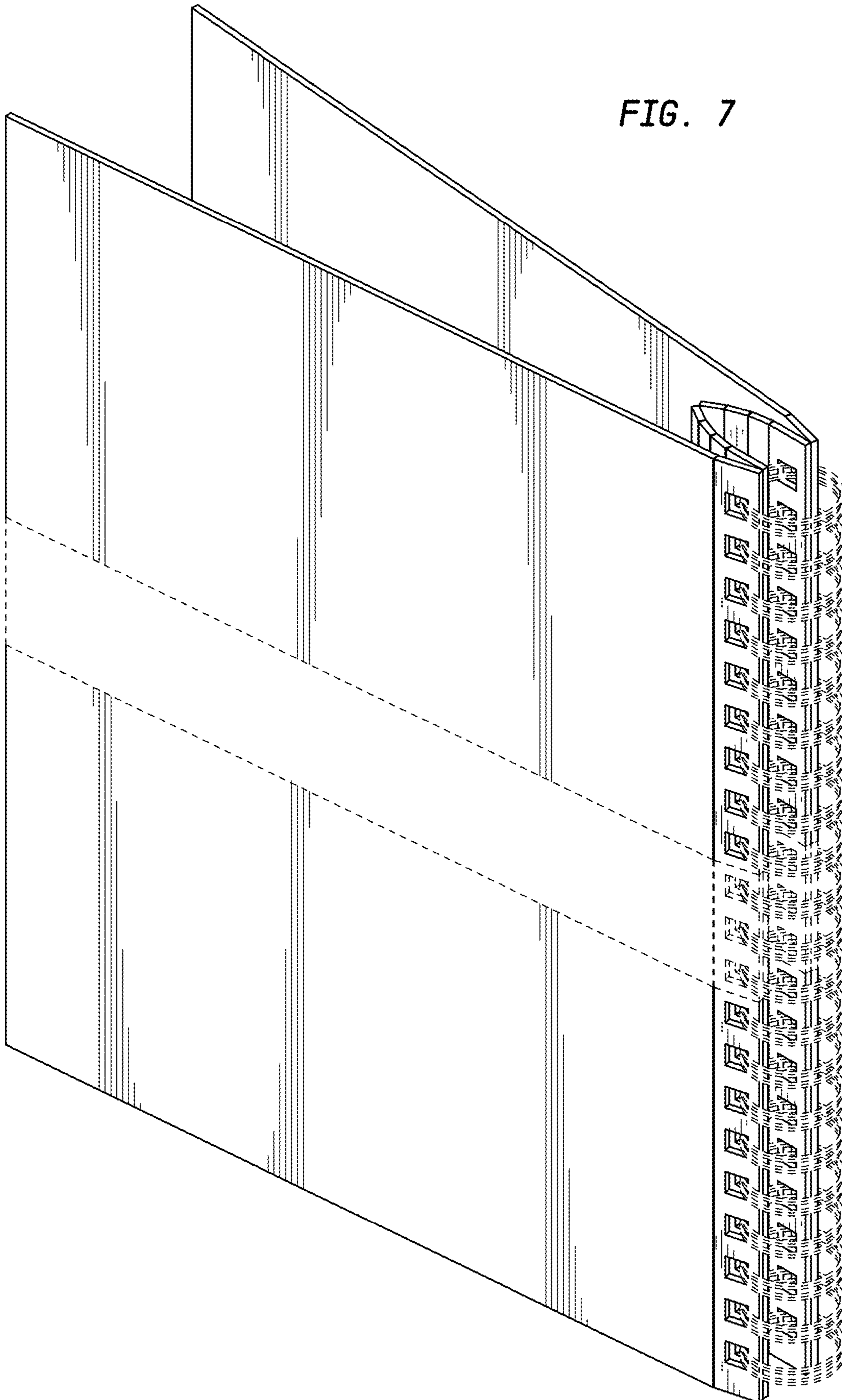

FIG. 8

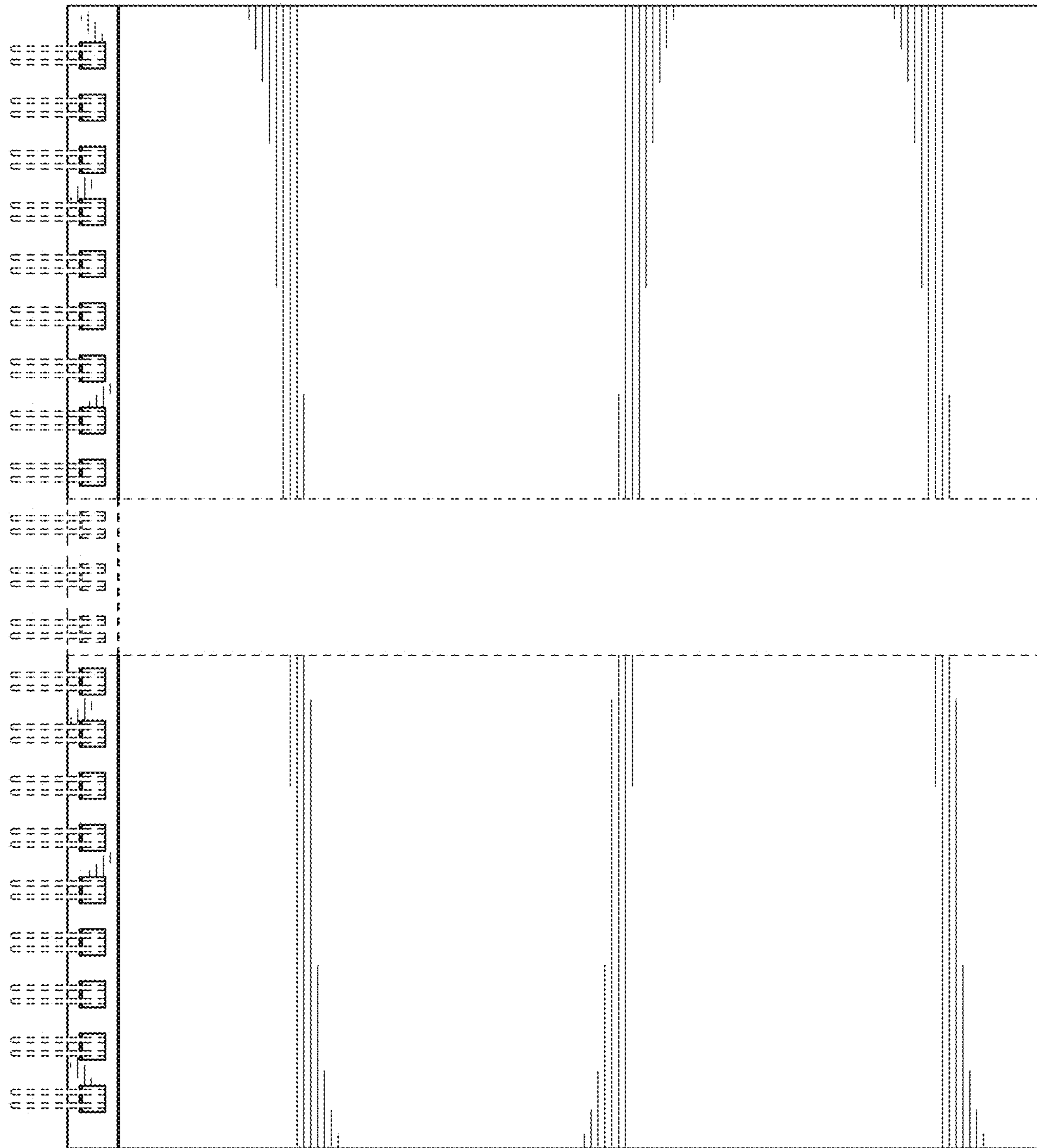

FIG. 9



FIG. 10

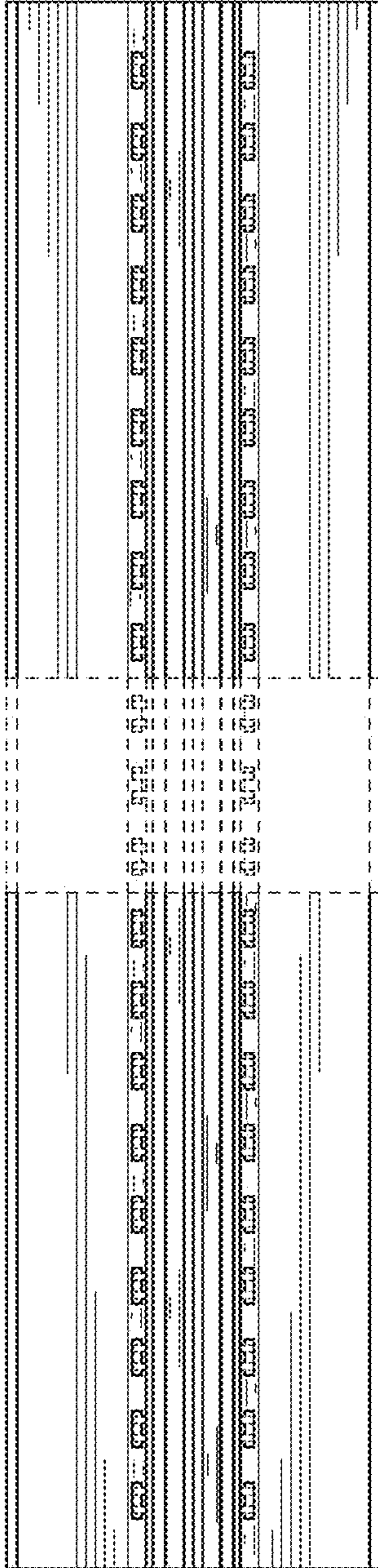

FIG. 11

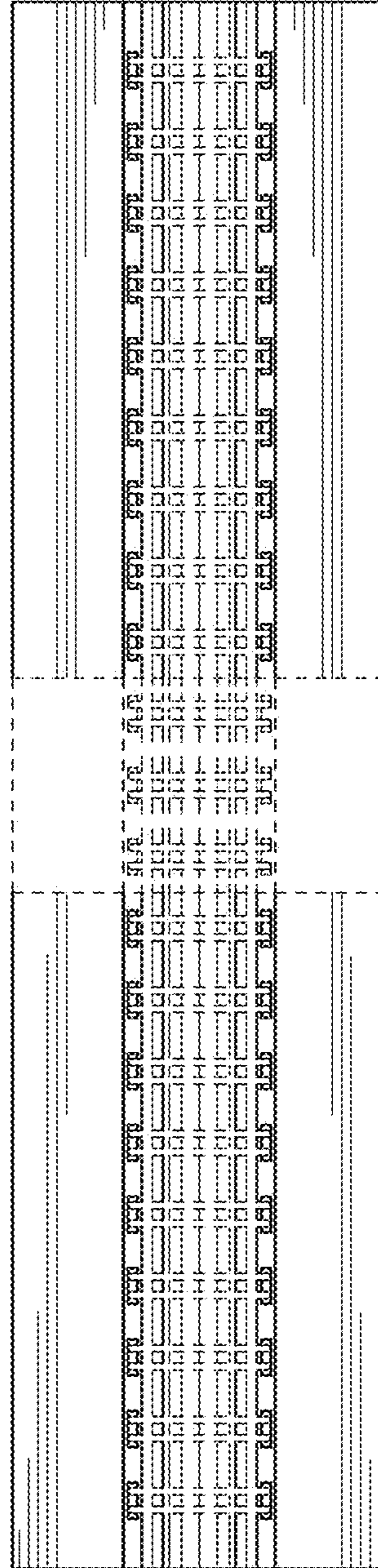

FIG. 12

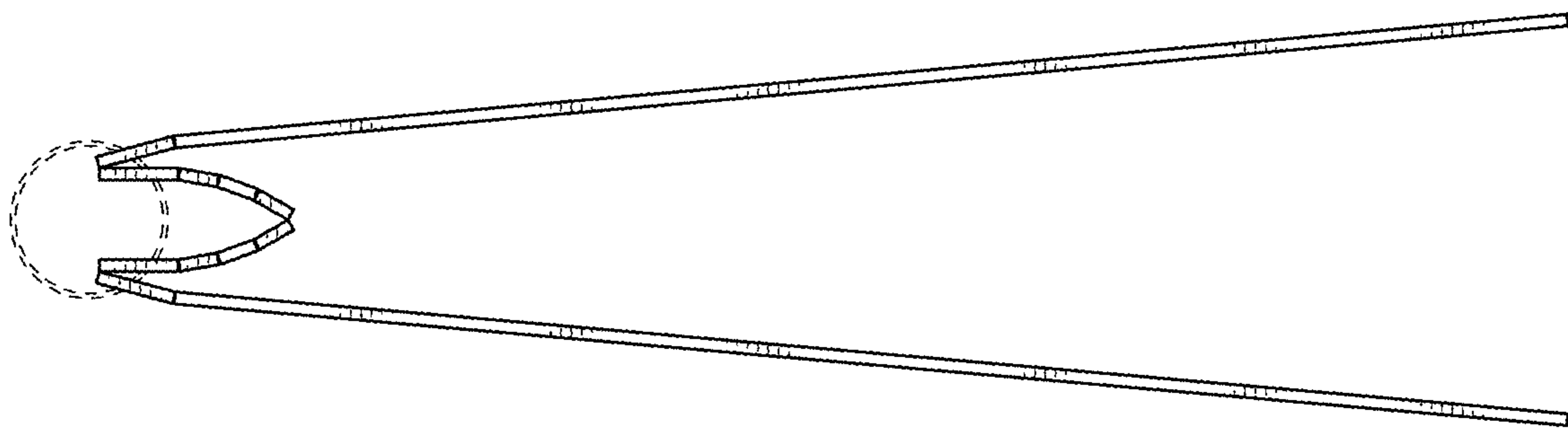

FIG. 13

