

US00D898733S

(12) **United States Design Patent**
Zhang

(10) **Patent No.:** **US D898,733 S**

(45) **Date of Patent:** **** Oct. 13, 2020**

(54) **LAPTOP COMPUTER**

G06F 3/0486; G06F 3/04883; H04M
1/0279; H04M 1/0281; H04M 1/0283

(71) Applicant: **Lenovo (Beijing) Co., Ltd.**, Beijing
(CN)

See application file for complete search history.

(72) Inventor: **Xin Zhang**, Beijing (CN)

(56) **References Cited**

(73) Assignee: **Lenovo (Beijing) Co., Ltd.**, Beijing
(CN)

U.S. PATENT DOCUMENTS

(**) Term: **15 Years**

D456,373 S *	4/2002	Usami	D14/129
D512,997 S *	12/2005	Lee	D14/318
D709,067 S *	7/2014	Ahn	D14/345
D737,809 S *	9/2015	Brehmer	D14/315
D750,616 S *	3/2016	Liang	D14/318
D823,849 S *	7/2018	Lim	D14/318
D826,928 S *	8/2018	Lee	D14/318

(21) Appl. No.: **35/506,379**

* cited by examiner

(22) Filed: **Dec. 12, 2018**

(80) **Hague Agreement Data**

Primary Examiner — Keli L Hill

Int. Filing Date: **Dec. 12, 2018**

(74) *Attorney, Agent, or Firm* — Oppedahl Patent Law
Firm LLC

Int. Reg. No.: **DM/200250**

Int. Reg. Date: **Dec. 12, 2018**

Int. Reg. Pub. Date: **Mar. 8, 2019**

(57) **CLAIM**

The ornamental design for a laptop computer, as shown and described.

(30) **Foreign Application Priority Data**

DESCRIPTION

Jul. 3, 2018 (CN) 2018 3 0350420

(51) **LOC (12) Cl.** **14-02**

(52) **U.S. Cl.**
USPC **D14/315; D14/327**

(58) **Field of Classification Search**
USPC ... D14/129, 130, 203.1, 203.3, 203.4, 203.7,
D14/300, 315-323, 327, 496
CPC A47B 21/04; A47B 2097/005; A47B
2097/006; A47B 2023/049; F16M 11/20;
F16M 13/00; A63H 33/3016; G06F
1/1613; G06F 1/1644; G06F 1/1647;

1. Laptop computer
 - 1.1 is a front elevation view.
 - 1.2 is a rear elevation view.
 - 1.3 is a left side elevation view.
 - 1.4 is a right side elevation view.
 - 1.5 is a top plan view.
 - 1.6 is a bottom plan view.
 - 1.7 is a top, front and right side perspective view.
- The broken lines shown in the drawings illustrate portions of the laptop computer that form no part of the claimed design.

1 Claim, 7 Drawing Sheets

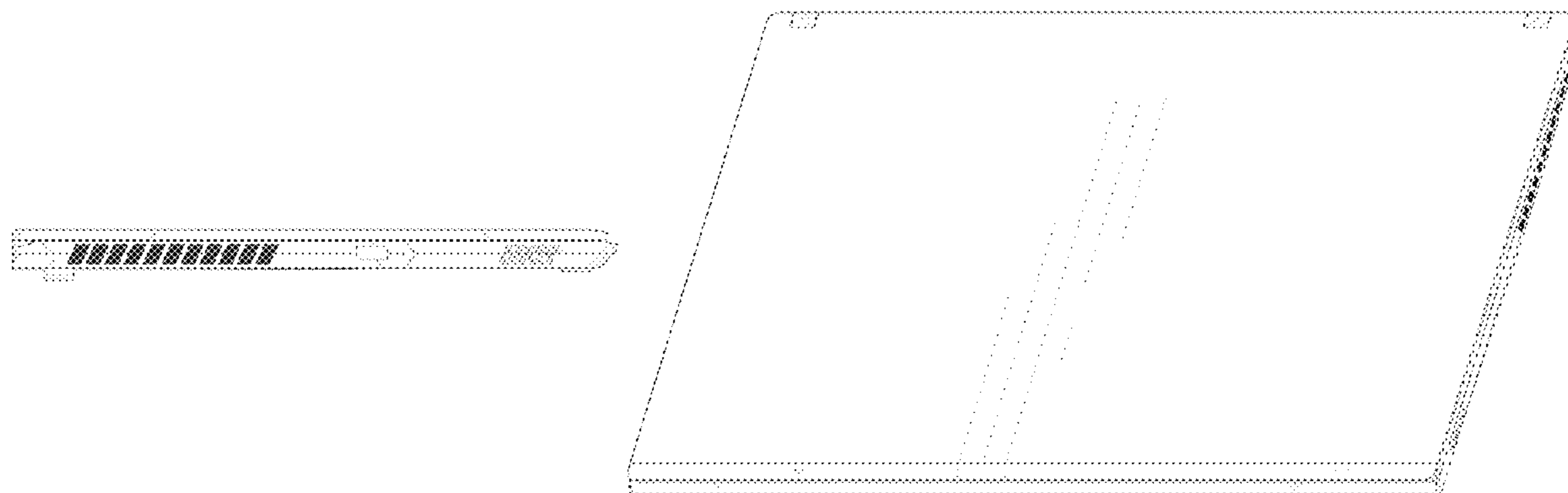

1.1

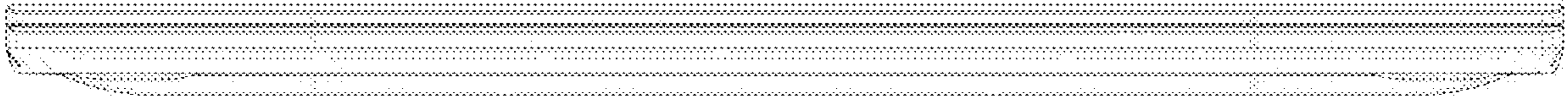

1.2

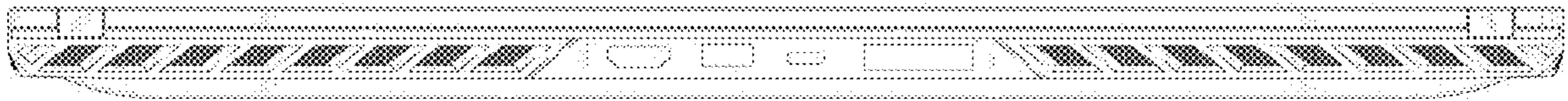

1.3

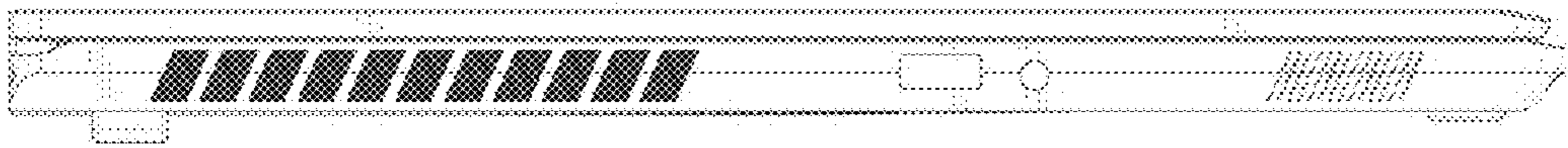

1.4

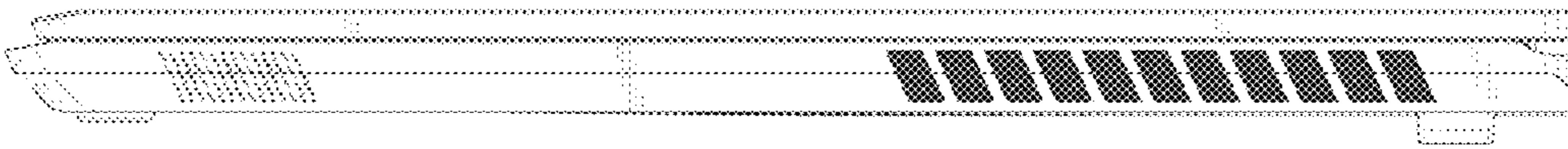

1.5

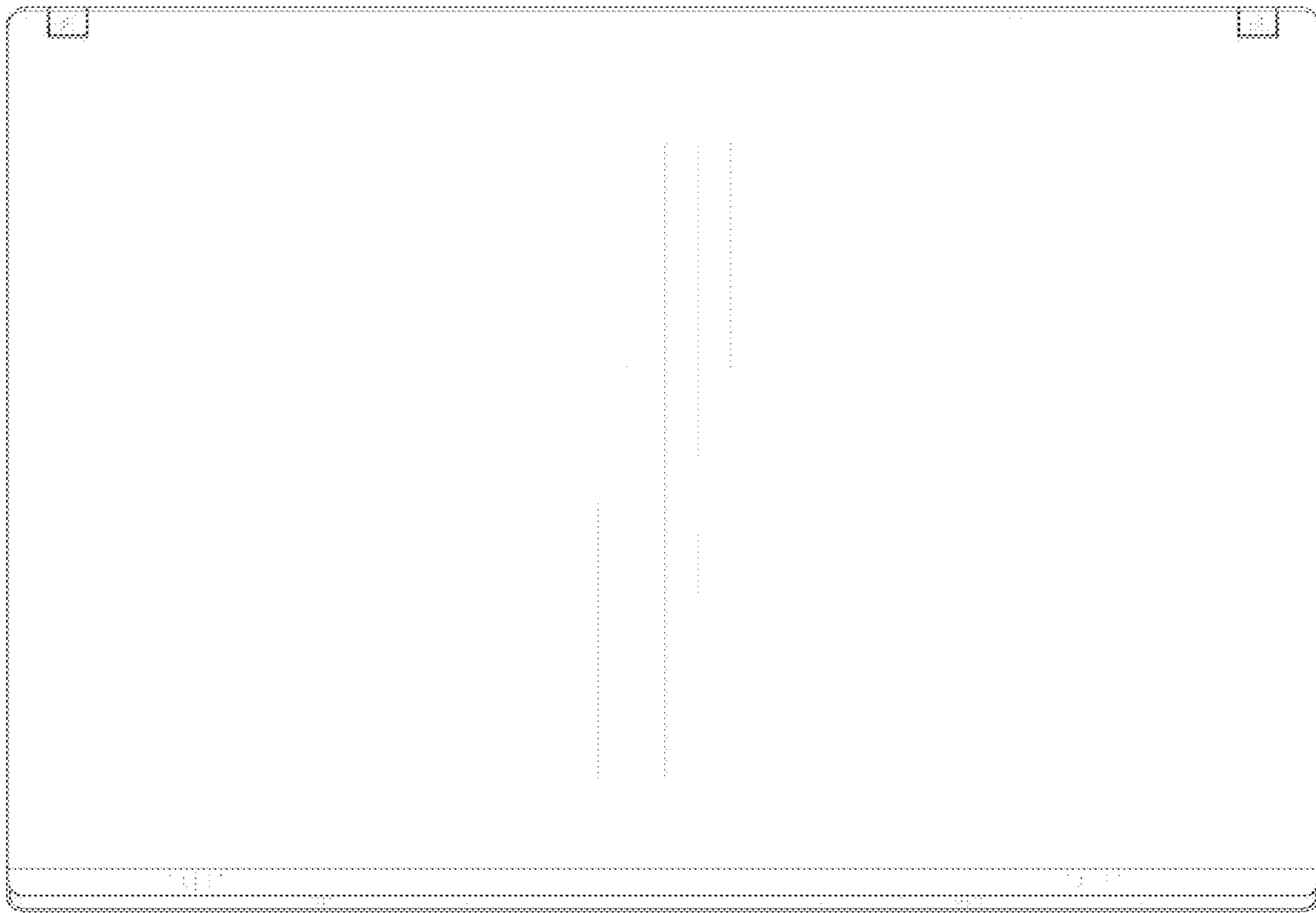

1.6

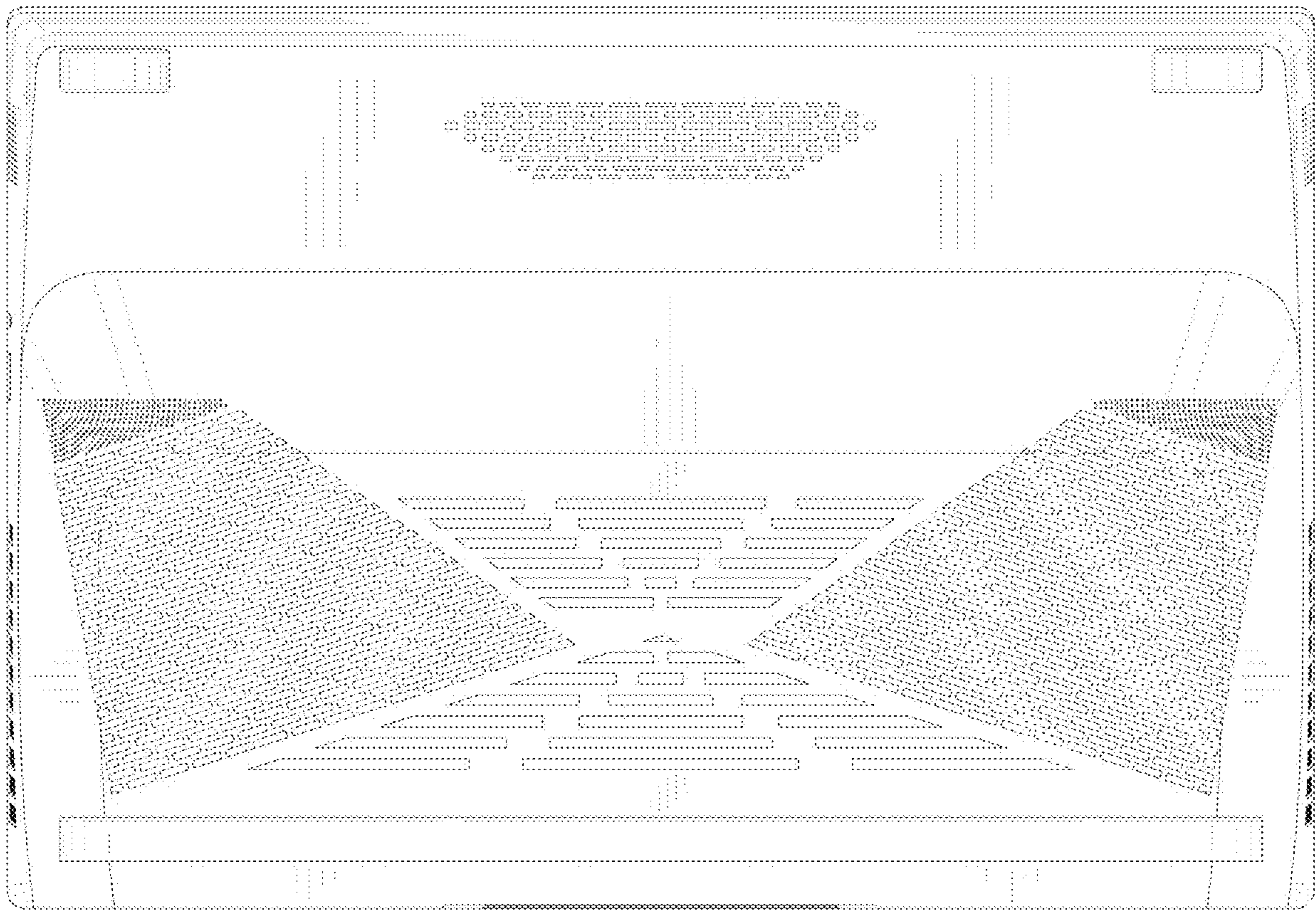

1.7

