



US00D898687S

(12) **United States Design Patent**  
**Kim et al.**

(10) **Patent No.:** **US D898,687 S**  
(45) **Date of Patent:** **\*\* Oct. 13, 2020**

(54) **TELEVISION RECEIVER**

- (71) Applicant: **Samsung Electronics Co., Ltd.**,  
Suwon-si (KR)
- (72) Inventors: **Ji-Gwang Kim**, Seoul (KR);  
**Dongwook Kim**, Seoul (KR);  
**Jeongwoo Park**, Seoul (KR); **Sang**  
**Young Lee**, Gwangmyeong-si (KR);  
**Su-An Choi**, Seoul (KR)
- (73) Assignee: **Samsung Electronics Co., Ltd.**,  
Suwon-si (KR)
- (\*\*) Term: **15 Years**
- (21) Appl. No.: **29/681,481**
- (22) Filed: **Feb. 26, 2019**
- (30) **Foreign Application Priority Data**

Aug. 29, 2018 (KR) ..... 30-2018-0040292

- (51) **LOC (12) Cl.** ..... **14-03**
- (52) **U.S. Cl.**  
USPC ..... **D14/126; D14/239**
- (58) **Field of Classification Search**  
USPC ..... D14/239, 238, 229, 224, 126, 127, 128  
CPC ..... G06F 1/1605; H04N 5/64; H04N 7/142;  
H04N 7/18  
See application file for complete search history.

(56) **References Cited**

**U.S. PATENT DOCUMENTS**

D634,722 S *	3/2011	Kim	.....	D14/126
D723,485 S *	3/2015	Hwangbo	.....	D14/126
D733,083 S *	6/2015	Hwangbo	.....	D14/126
D741,275 S *	10/2015	Huh	.....	D14/126
D797,085 S *	9/2017	So	.....	D14/126

(Continued)

**FOREIGN PATENT DOCUMENTS**

CN	201430392707.2	4/2015
CN	201430509448.7	7/2015

(Continued)

**OTHER PUBLICATIONS**

55" Class Q90T QLED 4K UHD HDR Smart TV, (c) 2020 [online],  
[retrieved Jun. 26, 2020], Retrieved from internet, URL: <https://  
www.samsung.com/us/televisions-home-theater/tvs/qled-4k-tvs/55-  
class-q90t-qled-4k-uhd-hdr-smart-tv-2020-qn55q90tafxza/> (Year:  
2020).\*

(Continued)

*Primary Examiner* — Barbara Fox

*Assistant Examiner* — Aram Kwon

(74) *Attorney, Agent, or Firm* — NSIP Law

(57) **CLAIM**

We claim the ornamental design for a television receiver, as  
shown and described.

**DESCRIPTION**

FIG. 1 is a front perspective view of a television receiver  
showing our new design;  
FIG. 2 is a front view thereof;  
FIG. 3 is a rear view thereof;  
FIG. 4 is a left-side view thereof;  
FIG. 5 is a right-side view thereof;  
FIG. 6 is a top view thereof;  
FIG. 7 is a bottom view thereof;  
FIG. 8 is a rear perspective view thereof;  
FIG. 9 is an enlarged view of the encircled portion in FIG.  
4;  
FIG. 10 is an enlarged view of the encircled portion in FIG.  
8; and,  
FIG. 11 is a rear perspective view thereof in which the stand  
feature is shown in another position.  
The dash-dash broken lines in the figures depict portions of  
the television receiver which form no part of the claimed  
design.  
The dot-dot-dash broken lines encircling portions of the  
claimed design that are illustrated in enlargements form no  
part of the claimed design.

**1 Claim, 9 Drawing Sheets**

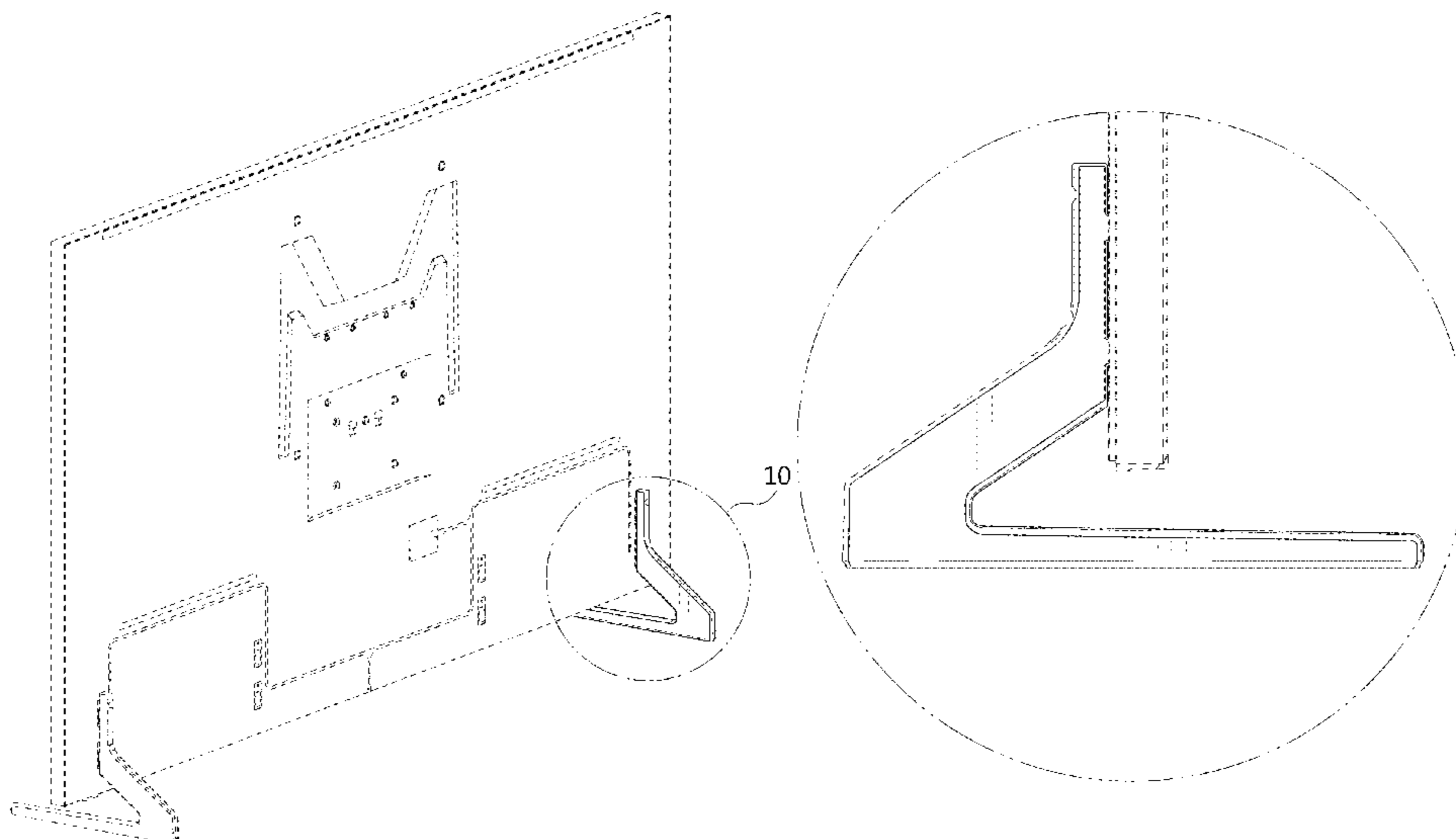

(56)

**References Cited**

U.S. PATENT DOCUMENTS

D817,902 S	*	5/2018	Lee .....	D14/126
D826,882 S	*	8/2018	Han .....	D14/126
D827,601 S	*	9/2018	Kim .....	D14/126
D864,928 S	*	10/2019	Masui .....	D14/239

FOREIGN PATENT DOCUMENTS

CN	201930078269.5	*	11/2019
CN	201930078386.1	*	11/2019
KR	30-2013-0022911		3/2014
KR	3020180040292	*	6/2019
WO	WOD201596-009	*	8/2019

OTHER PUBLICATIONS

Sony 49" Class 4K UHD LED Android Smart TV, (c) 2018 [online], [retrieved Jun. 26, 2020], Retrieved from internet, URL: <<https://www.walmart.com/reviews/product/918526326?page=2>> (Year: 2018).\*

Sony 85" Class 4K UHD LED Android Smart TV, (c) 2020 [online], [retrieved Jun. 26, 2020], Retrieved from internet, URL: <<https://www.walmart.com/reviews/product/833507494>> (Year: 2020).\*

TAVR Furniture. "TAVR Universal Table Top TV Stand for Most 22-65 inch Plasma LCD LED Flat or Curved Screen TVs, VESA Patterns up to 800mmx400mm, 88 Lbs Capacity, UT3001" [2018] www.amazon.com Feb. 26, 2018 <[https://www.amazon.com/TAVR-Universal-Plasma-Curved-Patterns/dp/B06XW7MLB4/ref=pd\\_sbs\\_23\\_21?\\_encoding=UTF8&pd\\_rd\\_i=B06XW7MLB4&pd\\_rd\\_r=GEZAXBETPFQRG0DXHJVW&pd\\_rd\\_w=kB0fb&pd\\_rd\\_wg=N0oVp&psc=1&refRID=GEZAXBETPFQRG0DXHJVW](https://www.amazon.com/TAVR-Universal-Plasma-Curved-Patterns/dp/B06XW7MLB4/ref=pd_sbs_23_21?_encoding=UTF8&pd_rd_i=B06XW7MLB4&pd_rd_r=GEZAXBETPFQRG0DXHJVW&pd_rd_w=kB0fb&pd_rd_wg=N0oVp&psc=1&refRID=GEZAXBETPFQRG0DXHJVW)>.

FITUEYES. "FITUEYES Universal Table Top TV Stand/Base VESA Pedestal Mount fits 23" to 60" LED LCD Flat Screen TV with Height Adjustment TT07201MB" [2018] www.amazon.com Feb. 26, 2018 <[https://www.amazon.com/FITUEYES-Universal-Pedestal-Adjustment-TT07201MB/dp/B06WRW8QXC/ref=pd\\_sbs\\_23\\_18?\\_encoding=UTF8&pd\\_rd\\_i=B06WRW8QXC&pd\\_rd\\_r=GEZAXBETPFQRG0DXHJVW&pd\\_rd\\_w=kB0fb&pd\\_rd\\_wg=N0oVp&psc=1&refRID=GEZAXBETPFQRG0DXHJVW](https://www.amazon.com/FITUEYES-Universal-Pedestal-Adjustment-TT07201MB/dp/B06WRW8QXC/ref=pd_sbs_23_18?_encoding=UTF8&pd_rd_i=B06WRW8QXC&pd_rd_r=GEZAXBETPFQRG0DXHJVW&pd_rd_w=kB0fb&pd_rd_wg=N0oVp&psc=1&refRID=GEZAXBETPFQRG0DXHJVW)>.

\* cited by examiner

FIG. 1

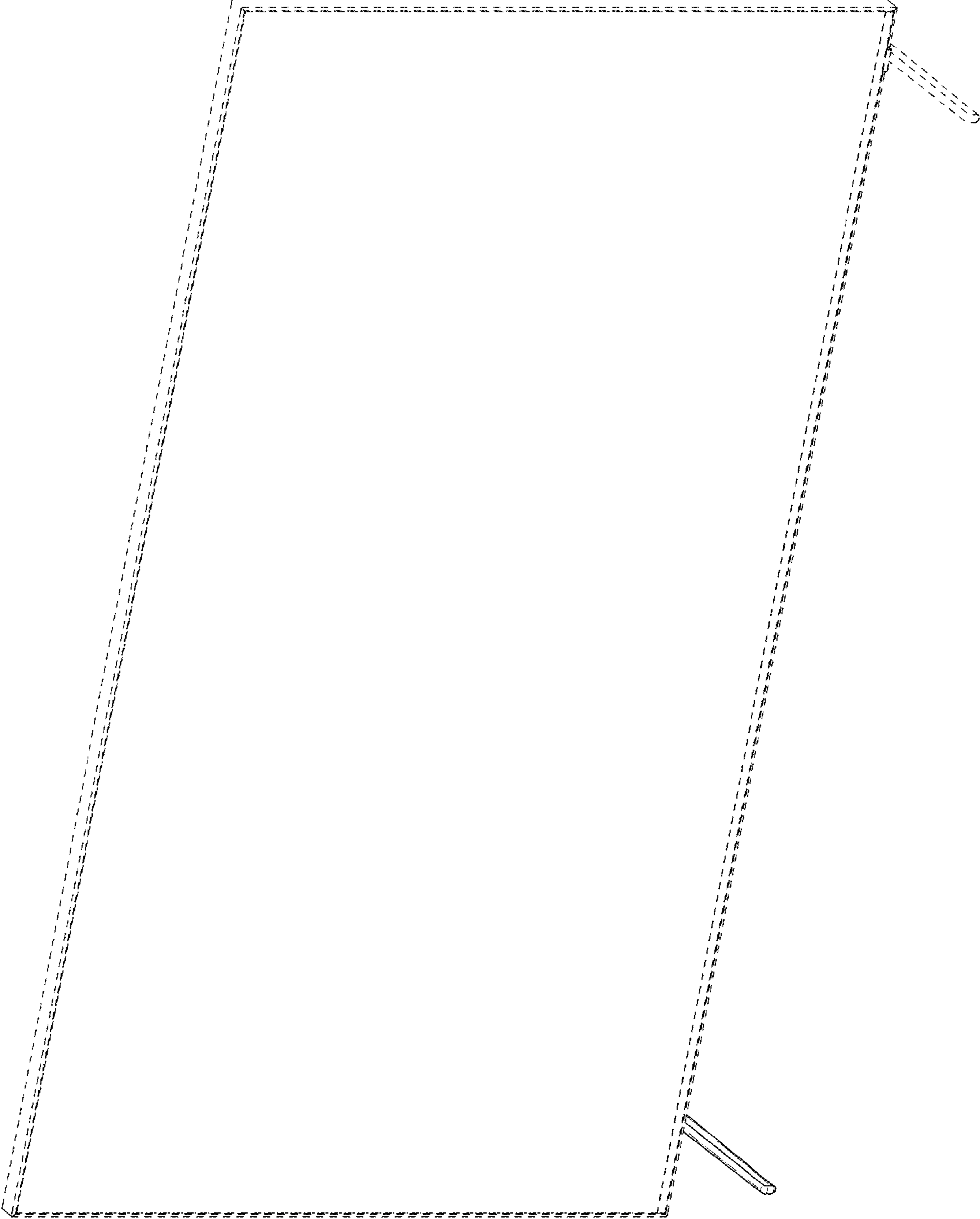

FIG. 2

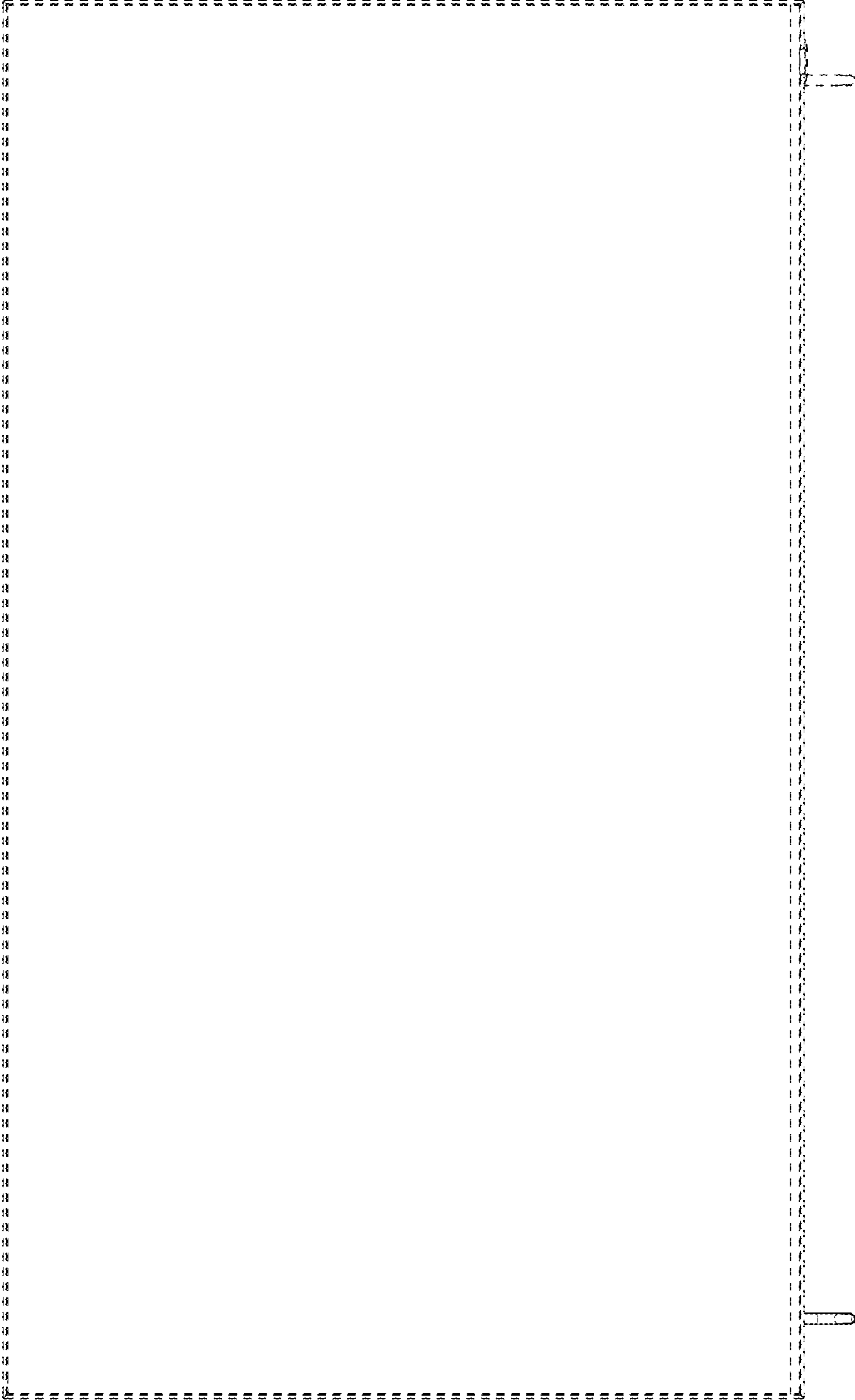



FIG. 5

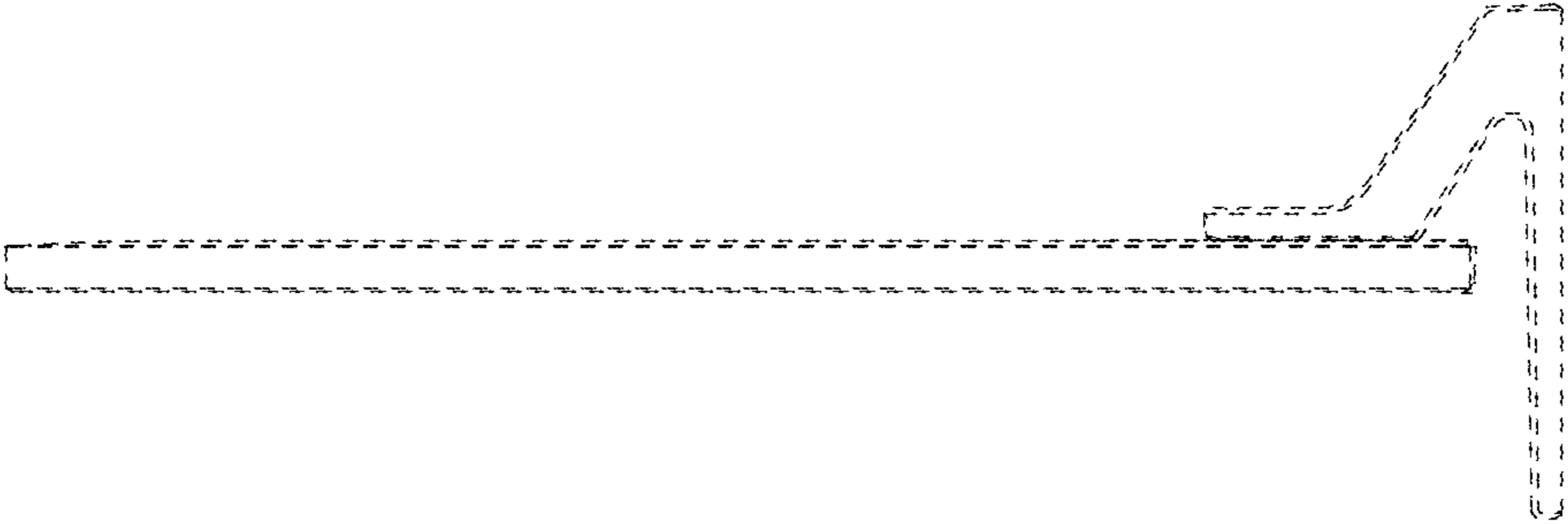

FIG. 4

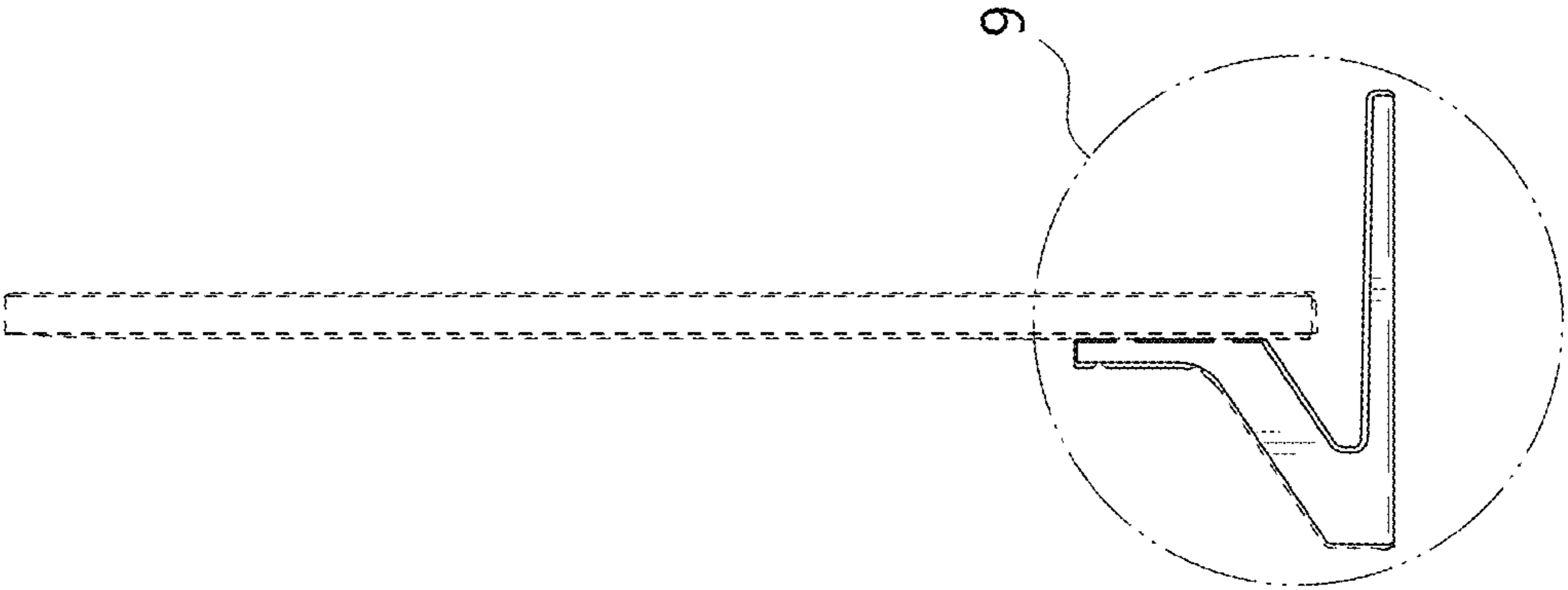

FIG. 6

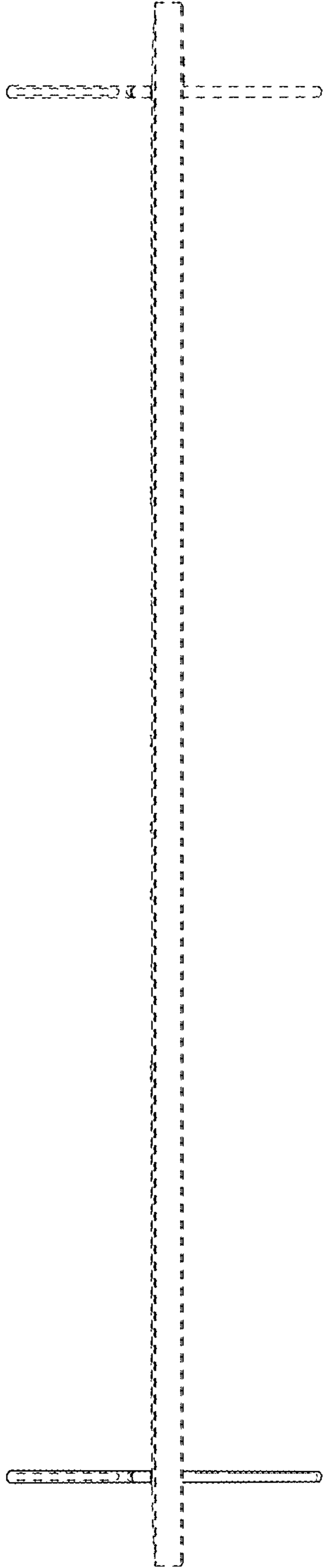
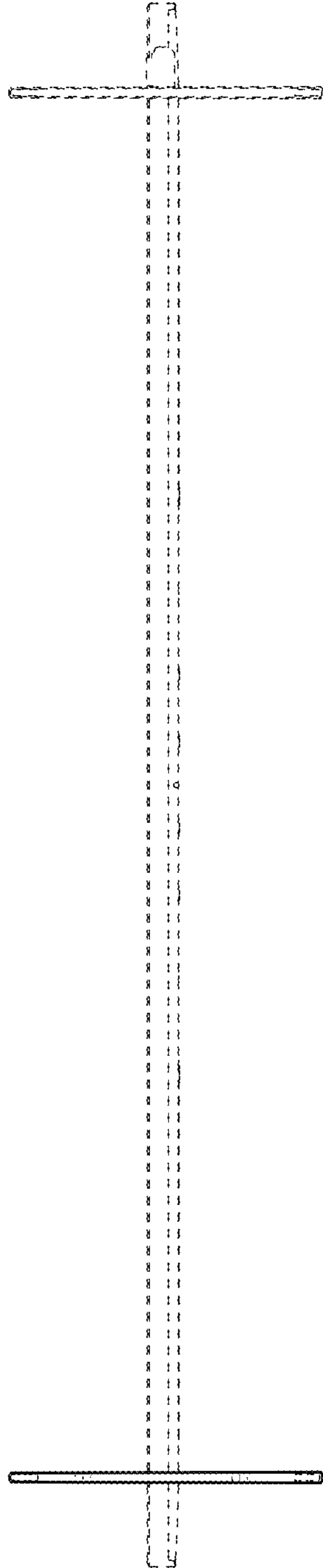

FIG. 7



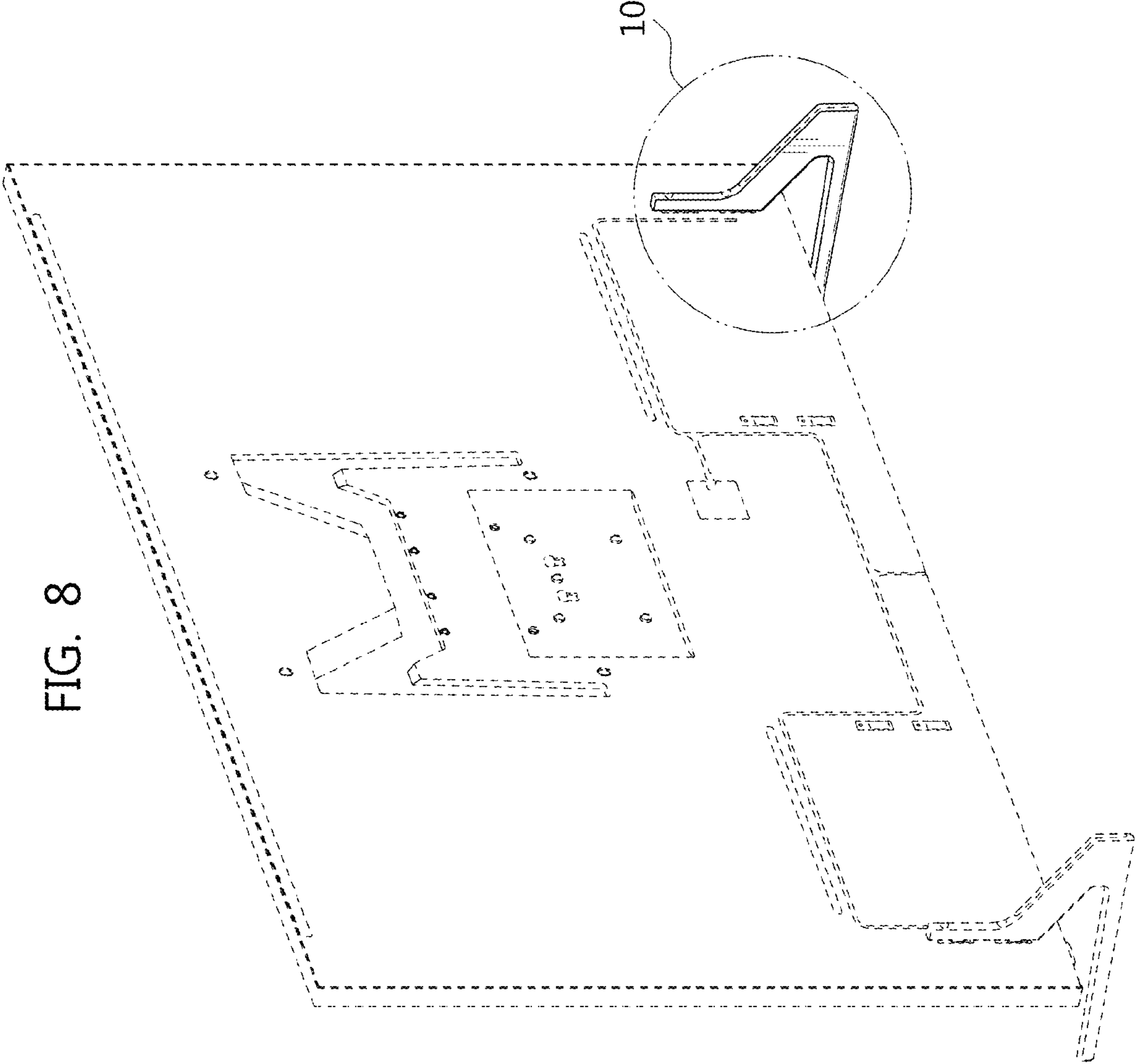
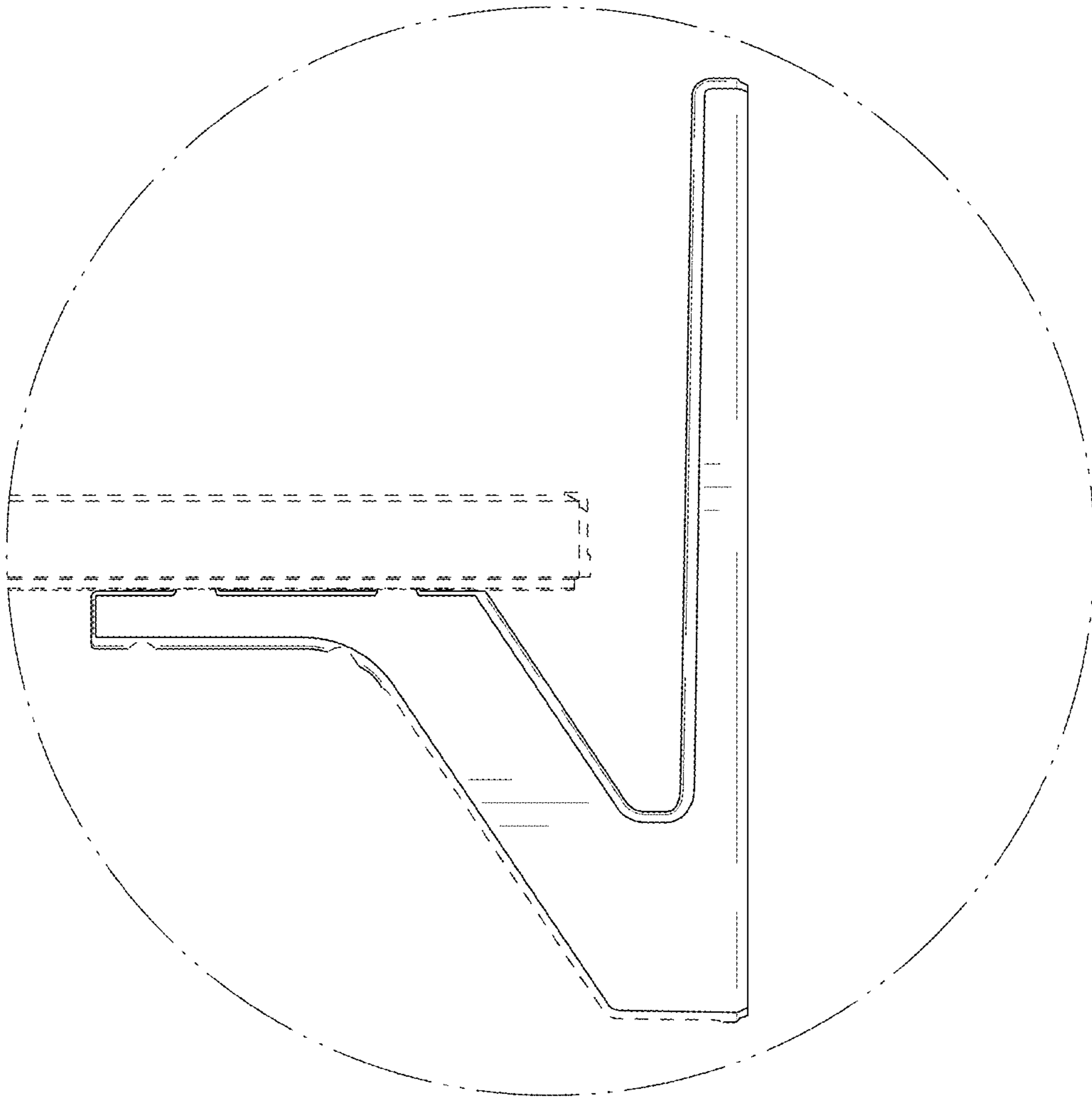

FIG. 8



FIG. 9



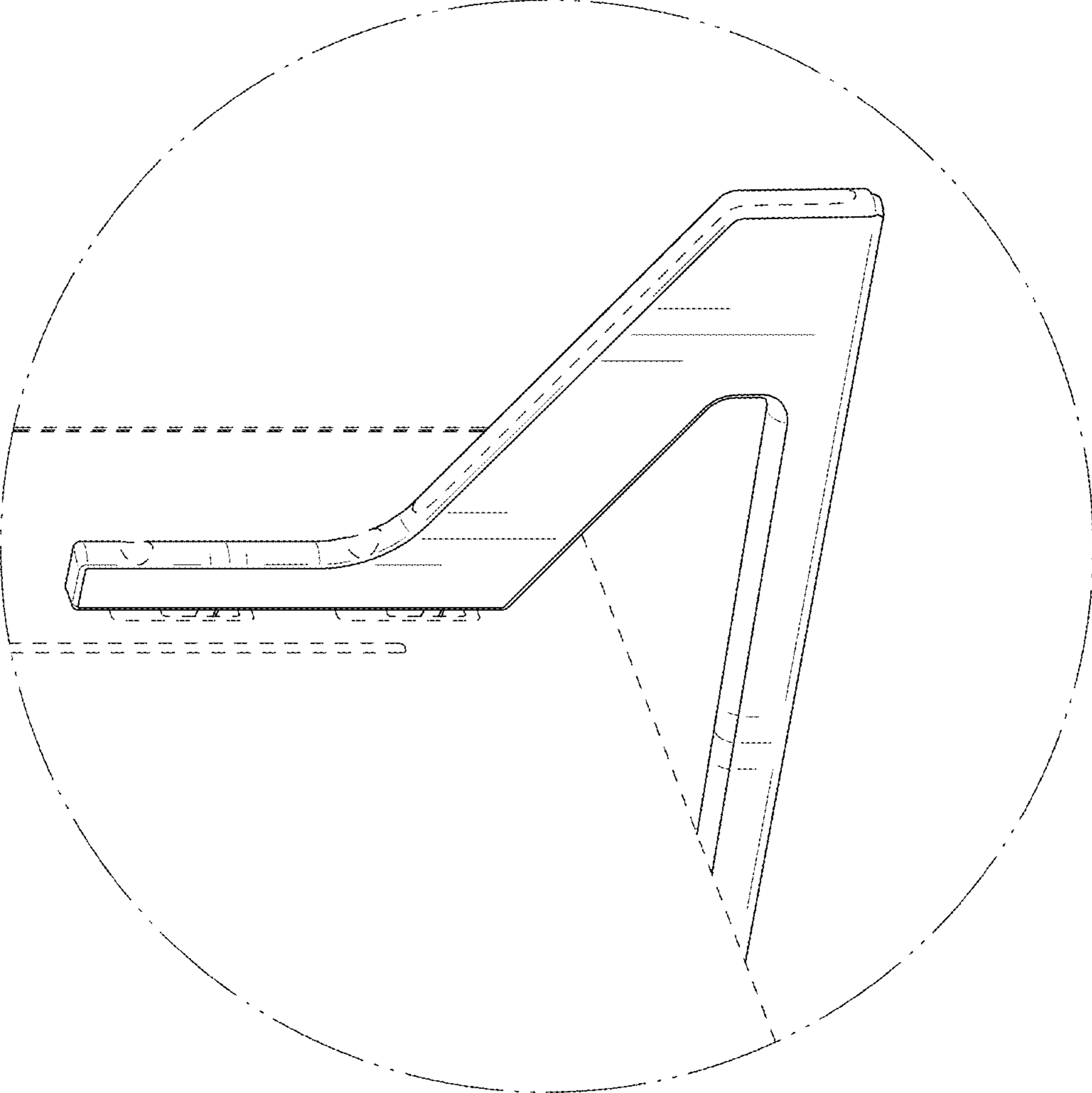

FIG. 10

FIG. 11

