

US00D898684S

(12) **United States Design Patent** (10) **Patent No.:** **US D898,684 S**
Tomerlin et al. (45) **Date of Patent:** **** Oct. 13, 2020**

(54) **TRANSMITTER**
(71) Applicant: **The Chamberlain Group, Inc.**, Oak Brook, IL (US)
(72) Inventors: **Kenneth F. Tomerlin**, Darien, IL (US); **Darryl P. De Wind**, West Olive, MI (US)
(73) Assignee: **The Chamberlain Group, Inc.**, Oak Brook, IL (US)
(**) Term: **15 Years**
(21) Appl. No.: **29/679,142**
(22) Filed: **Feb. 1, 2019**

3,975,723 A 8/1976 Bowling
4,278,968 A 7/1981 Arnett
D309,890 S 8/1990 Cheng
D315,527 S 3/1991 Weirsman
D351,591 S 10/1994 Chen
D351,841 S 10/1994 Blankenship
D354,500 S 1/1995 Georgopoulos
5,402,105 A 3/1995 Doyle
D357,201 S 4/1995 Novack
D357,919 S 5/1995 Tsui
5,471,195 A 11/1995 Rickman
D375,909 S 11/1996 Dziersk
D377,458 S 1/1997 Tsui
D377,767 S 2/1997 Doppelt
D378,200 S 2/1997 Doppelt
D379,993 S 6/1997 Devitt
D380,694 S 7/1997 Seki
D380,696 S 7/1997 Doppelt
D381,009 S 7/1997 Nagata

(Continued)

Related U.S. Application Data

(60) Continuation of application No. 29/628,100, filed on Dec. 1, 2017, now Pat. No. Des. 843,954, which is a division of application No. 29/573,550, filed on Aug. 8, 2016, now Pat. No. Des. 813,825.

(51) **LOC (12) Cl.** **14-03**
(52) **U.S. Cl.**
USPC **D13/168**

(58) **Field of Classification Search**
USPC D13/168; D14/218; D10/104.1, 106.1
CPC H03J 1/0025; H03J 9/00; H03J 9/02; H03J 9/04; H03J 9/06; H04B 1/202; G05B 11/01; G08C 17/00; G08C 17/02; G08C 19/28; G07C 9/00309; G07C 9/00182; G07C 9/00944; G07C 9/00174; G07C 2009/00206; G07C 2009/00214; G07C 2009/00928; E05F 15/77

See application file for complete search history.

(56) **References Cited**

U.S. PATENT DOCUMENTS

D168,149 S 11/1952 Edwards
D219,028 S 10/1970 Miller et al.

Primary Examiner — Selina Sikder

(74) *Attorney, Agent, or Firm* — Fitch, Even, Tabin & Flannery LLP

(57) **CLAIM**

We claim the ornamental design for a transmitter, as shown and described.

DESCRIPTION

FIGS. 1-7 are perspective, left side elevation, right side elevation, top, bottom, front elevation and rear elevation views, respectively, of transmitter in accordance with a first embodiment of our new design; and, FIGS. 8-14 are perspective, left side elevation, right side elevation, top, bottom, front elevation and rear elevation views, respectively, of transmitter in accordance with a second embodiment of our new design. In the drawings, the broken lines depict portions of the transmitter that form no part of the claimed design.

1 Claim, 8 Drawing Sheets

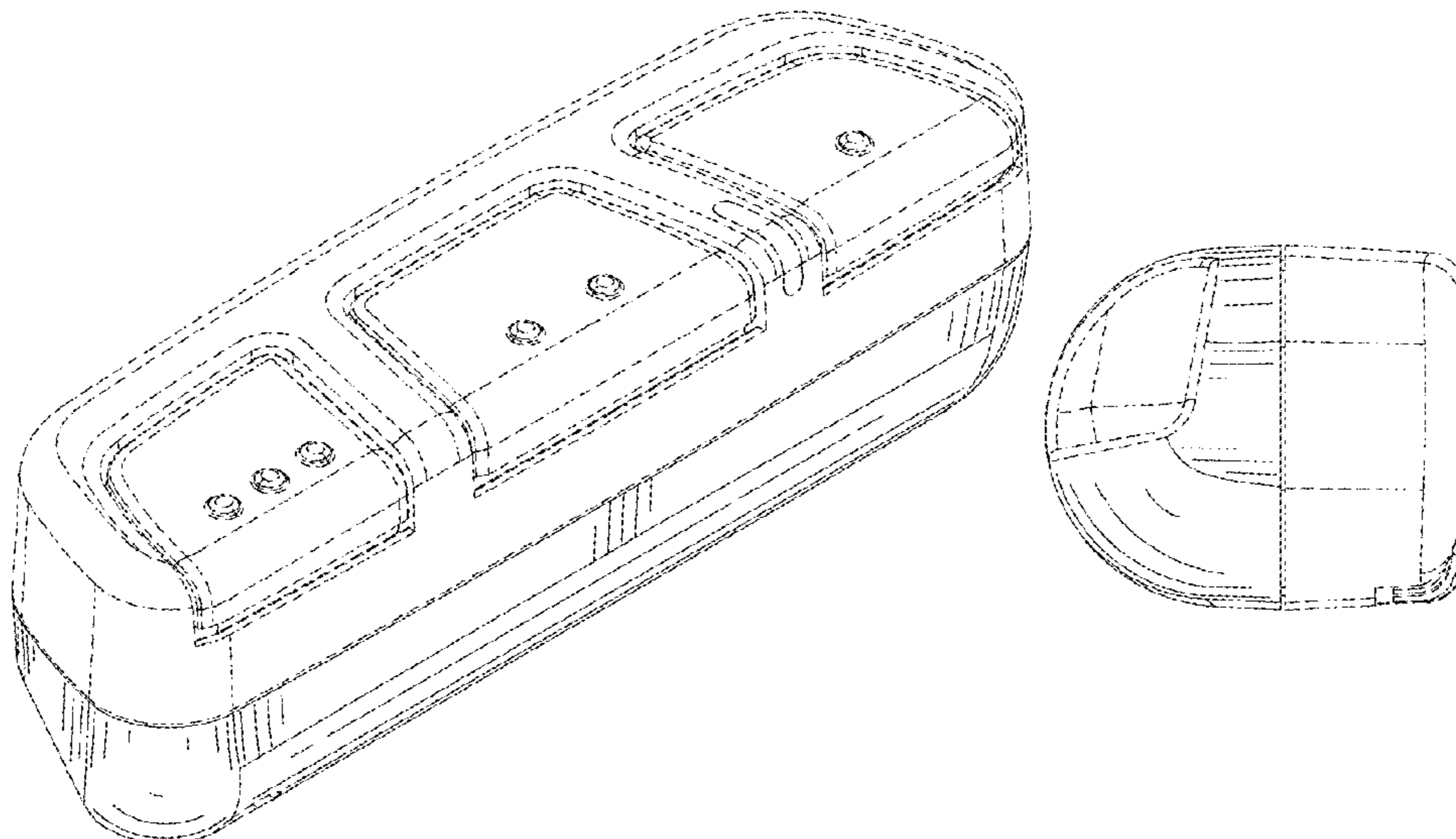

(56)

References Cited

U.S. PATENT DOCUMENTS

D381,662 S	7/1997	Weissberg	D485,551 S	1/2004	Nylen	
D381,962 S	8/1997	Doppelt	D490,380 S	5/2004	Coullahan	
D383,687 S	9/1997	Conrado	D490,403 S	5/2004	Wang	
D383,895 S	9/1997	Christie	D493,165 S	7/2004	Krapfl	
D385,878 S	11/1997	Flick	D494,144 S	8/2004	Guzman	
5,689,236 A	11/1997	Kister	D497,318 S	10/2004	Strand	
D392,944 S	3/1998	Issa	D499,087 S	11/2004	Peng	
D393,859 S	4/1998	Nguyen	D501,643 S	2/2005	Strand	
5,798,681 A	8/1998	Chang	D532,001 S	11/2006	Burke	
D399,155 S	10/1998	Roberts	D535,650 S	1/2007	Wong	
D405,424 S	2/1999	Winkler	D535,651 S	1/2007	Wong	
D406,107 S	2/1999	Flick	D548,702 S	8/2007	Girard	
5,883,579 A	3/1999	Schreiner	D549,182 S	8/2007	Girard	
D409,577 S	5/1999	Doppelt	D552,040 S	10/2007	Girard	
D413,579 S	9/1999	Mullet	D556,701 S	12/2007	Nohara	
D415,743 S	10/1999	Inukai	D559,234 S	1/2008	Girard	
D415,769 S	10/1999	Waldner	D561,703 S	2/2008	Shimokawa	
D424,065 S	5/2000	Soo	D571,305 S	6/2008	Thursfield	
6,091,343 A	7/2000	Dykema	D590,780 S	4/2009	DeBoer	
D429,238 S	8/2000	Kolinen	D592,158 S	5/2009	Peterson	
D432,551 S	10/2000	Luke	D638,394 S	5/2011	Richards	
D435,041 S	12/2000	Blasingame	D667,382 S	9/2012	Cosentino	
D437,308 S	2/2001	Gasa	8,598,983 B2	12/2013	Hattori	
D438,199 S	2/2001	Arpe	D722,983 S	2/2015	Paredes	
D438,533 S	3/2001	Arpe	D725,049 S	3/2015	Paredes	
D441,185 S	5/2001	Shimizu	D748,066 S	1/2016	Lee	
6,225,913 B1	5/2001	Slomowitz	D751,515 S	3/2016	Paredes	
6,310,548 B1	10/2001	Stephens, Jr.	D806,043 S	12/2017	Miller	
6,353,383 B1	3/2002	Gross	D813,825 S	3/2018	Tomerlin	
D465,215 S	11/2002	Read	D843,954 S *	3/2019	Tomerlin D13/168
D465,481 S	11/2002	Haaparanta	2002/0008610 A1	1/2002	Peterson	
D468,274 S	1/2003	Novak	2004/0006707 A1	1/2004	Pretzlaff	
D470,839 S	2/2003	Tuhkanen	2004/0099430 A1	5/2004	Scudder	
D470,852 S	2/2003	Kim	2004/0140883 A1	7/2004	Jalil	
6,522,258 B1	2/2003	Lott	2008/0147304 A1	6/2008	Pai	
6,529,142 B2	3/2003	Yeh	2010/0238640 A1	9/2010	Yang	
D473,221 S	4/2003	Herrmann	2012/0087096 A1	4/2012	Shen	
6,597,291 B2	7/2003	Tsui	2015/0302738 A1	10/2015	Geerlings	
D478,605 S	8/2003	Guzman	2016/0037664 A1	2/2016	Hendricks	
D484,120 S	12/2003	Yin	2017/0019372 A1	1/2017	Panje	
			2017/0034485 A1	2/2017	Scalisi	

* cited by examiner

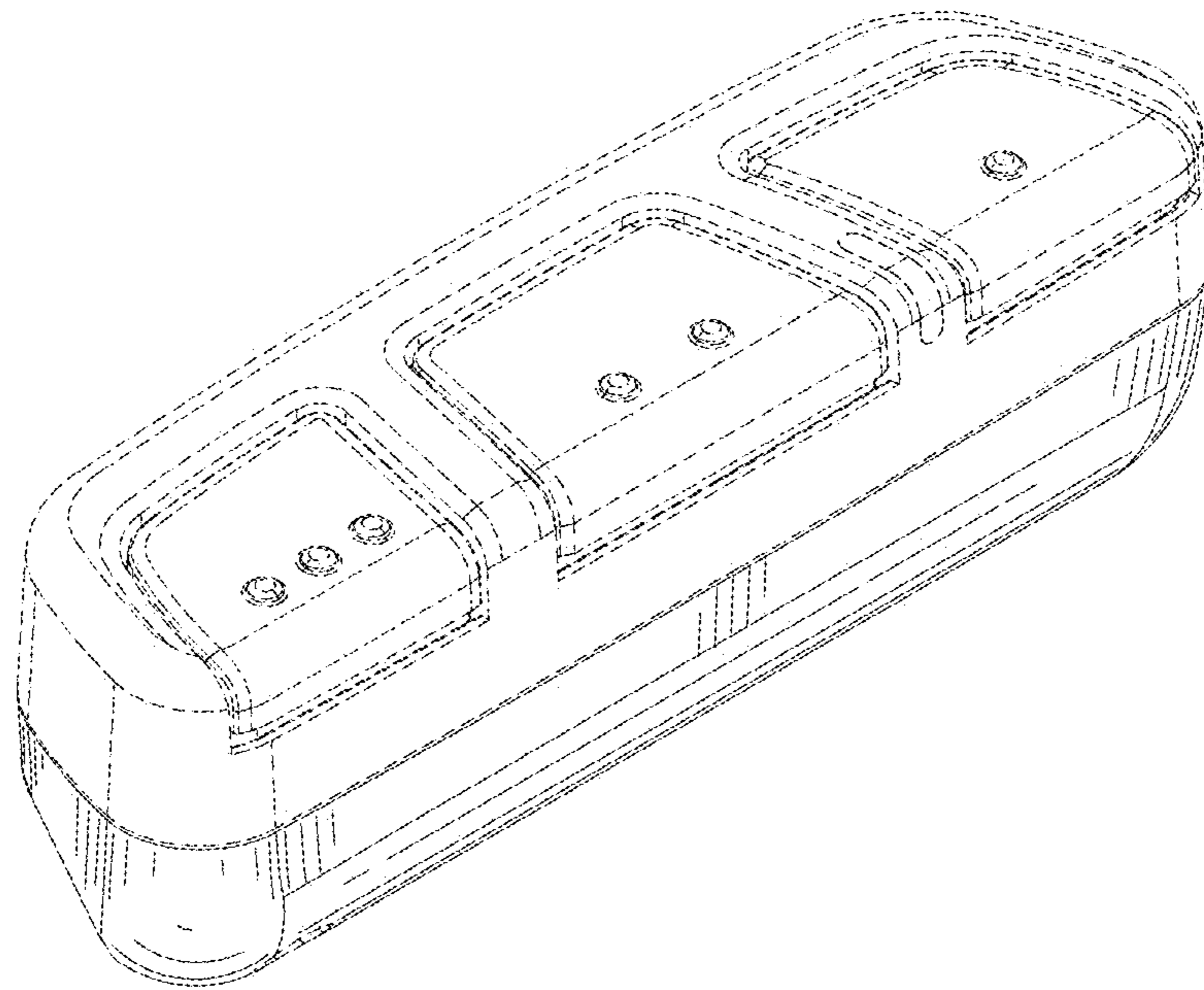

FIG. 1

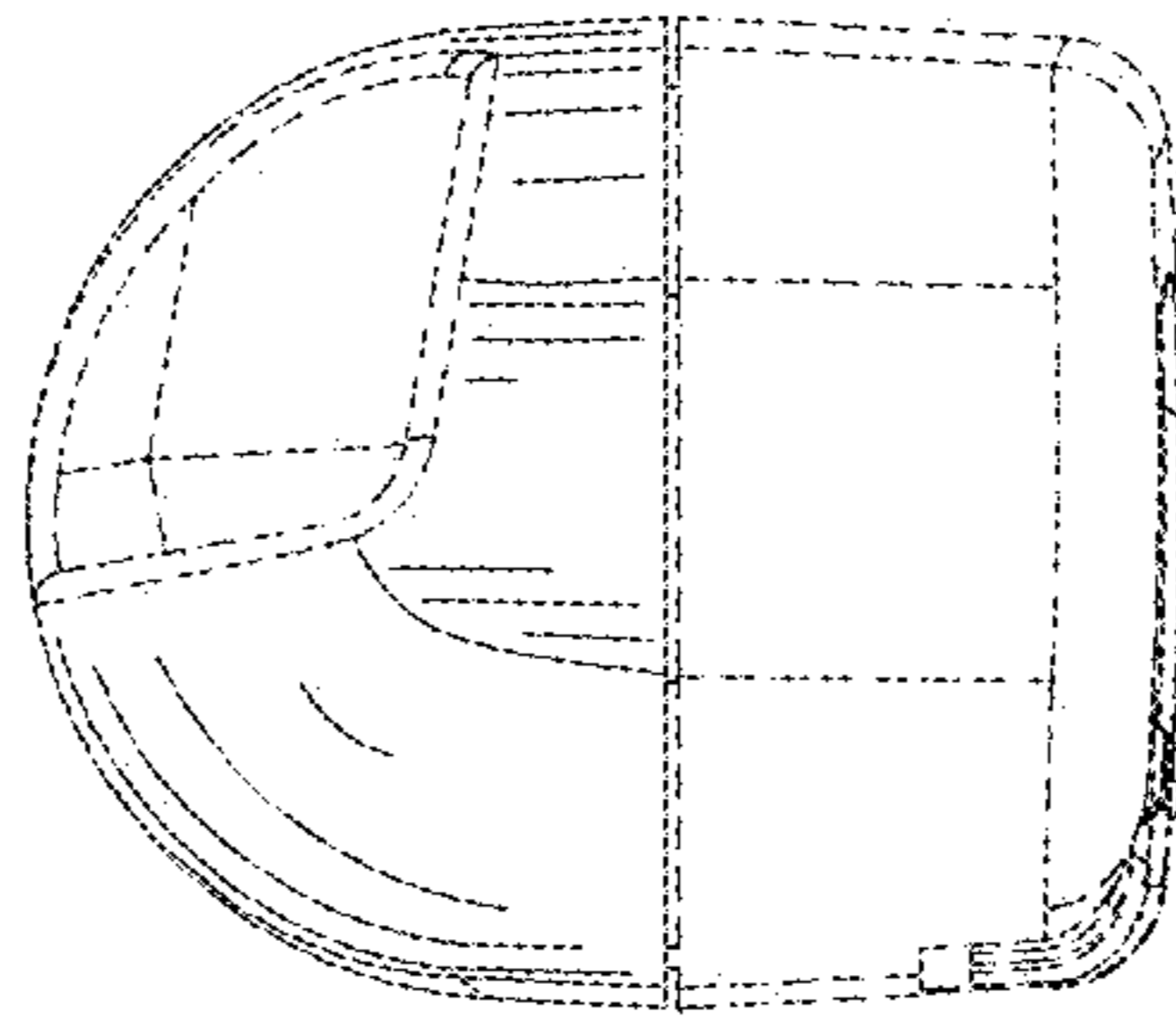

FIG. 2

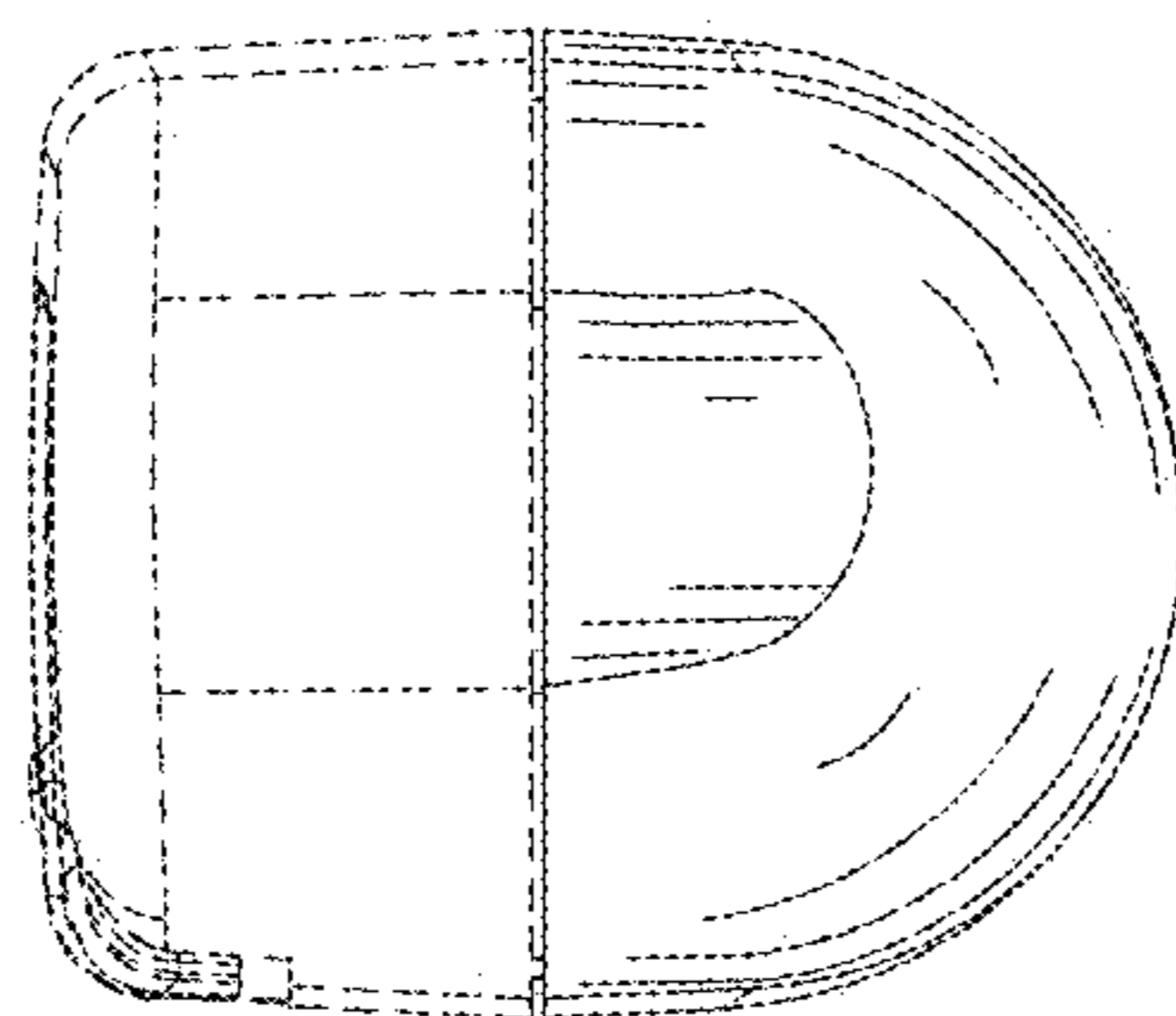

FIG. 3

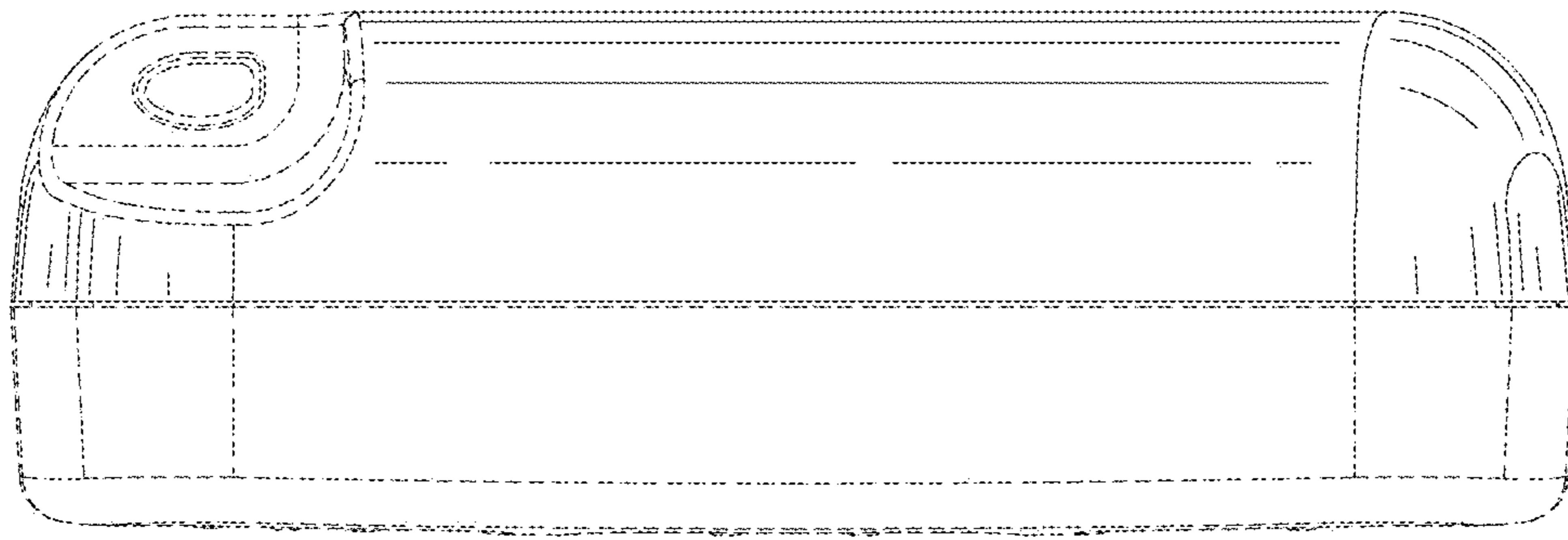

FIG. 4

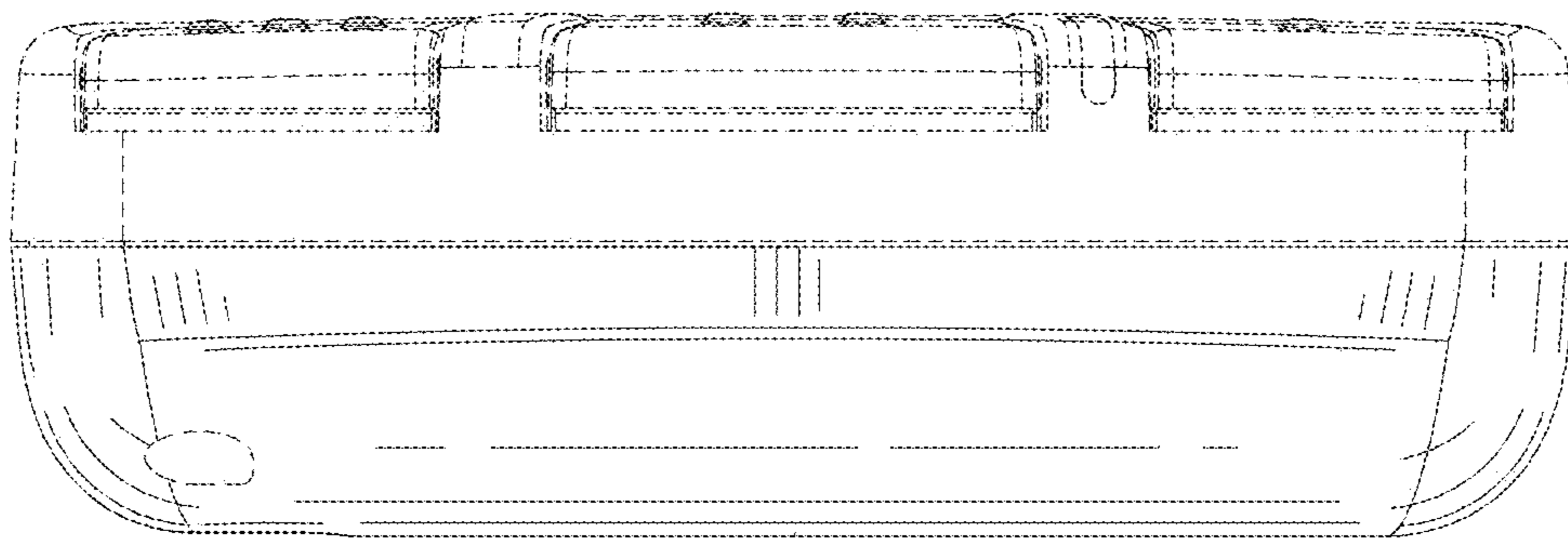

FIG. 5

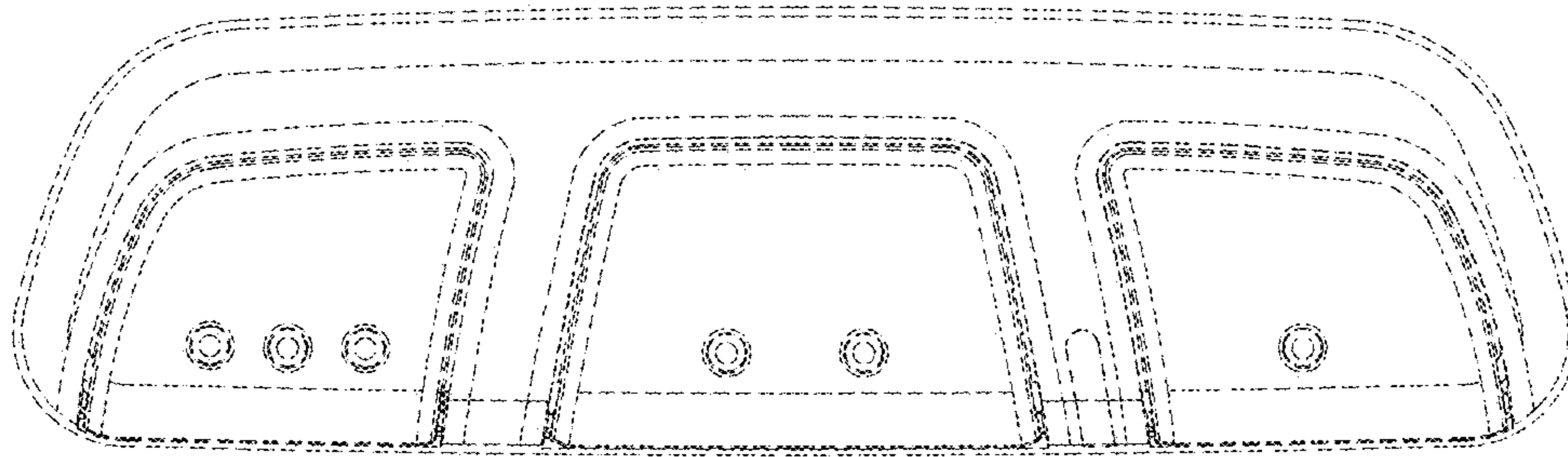

FIG. 6

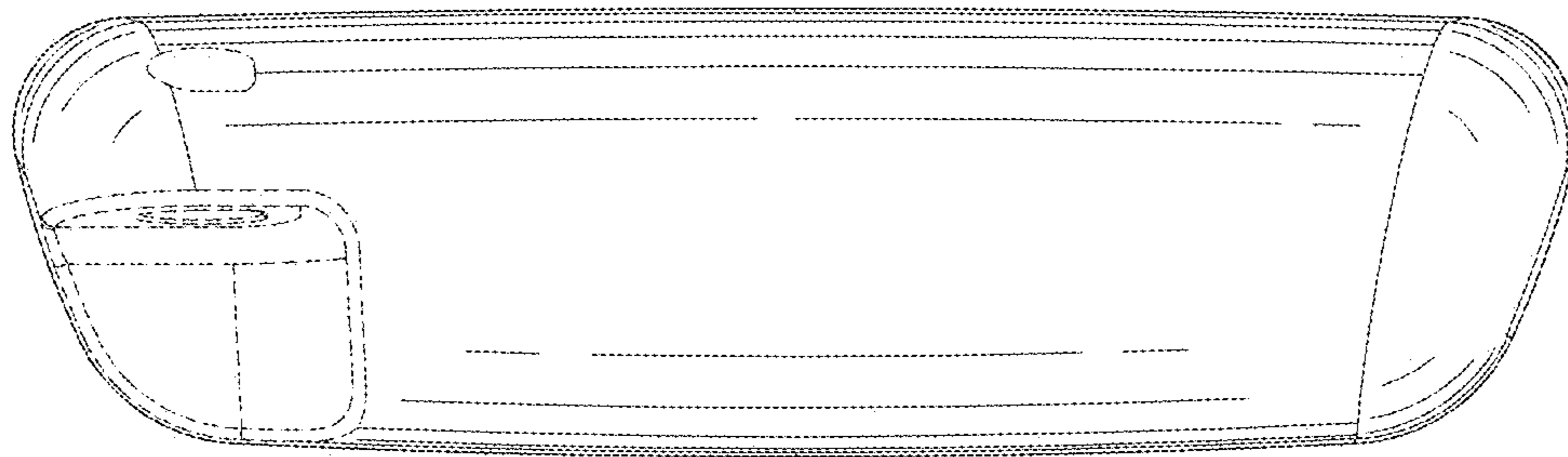

FIG. 7

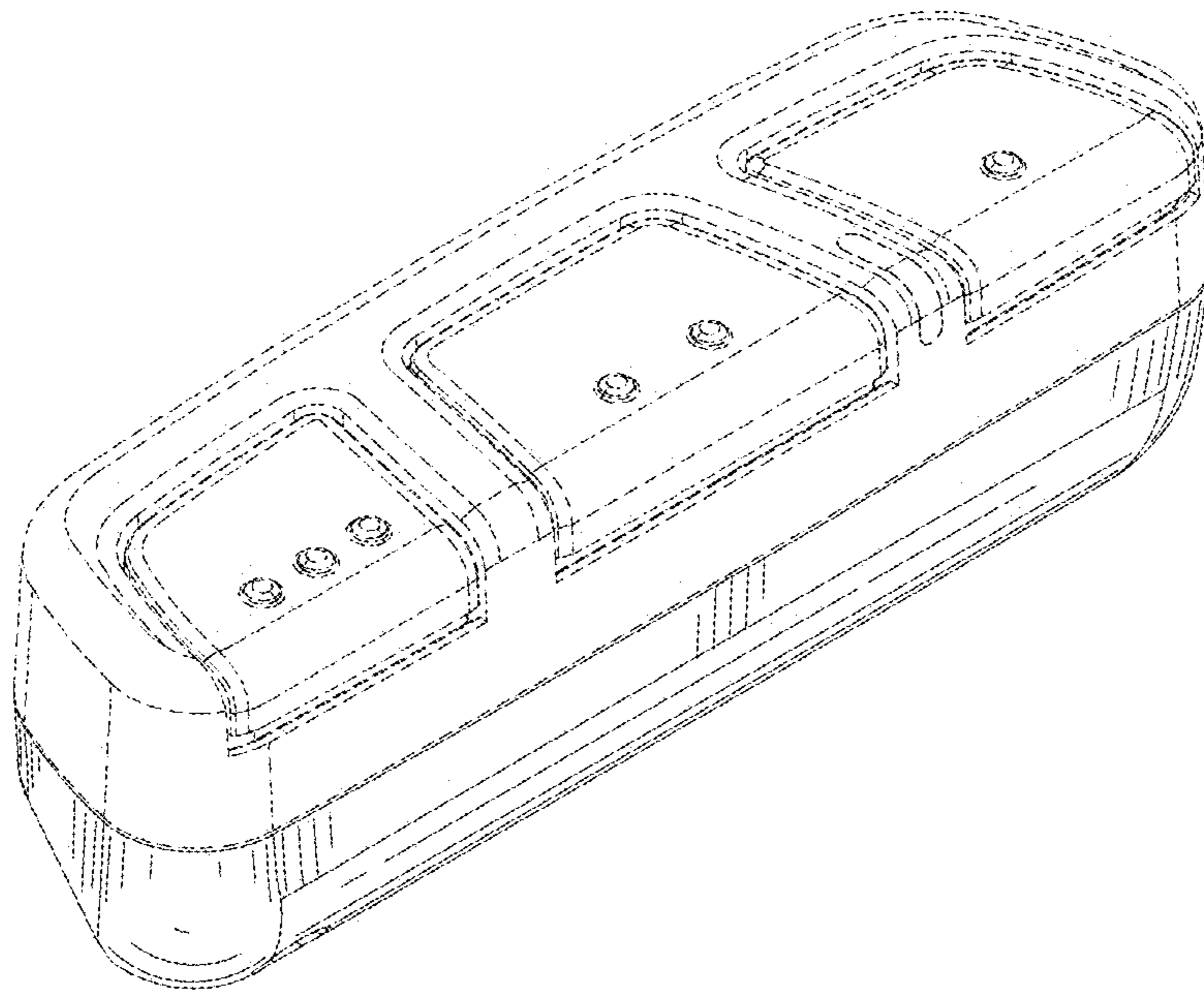

FIG. 8

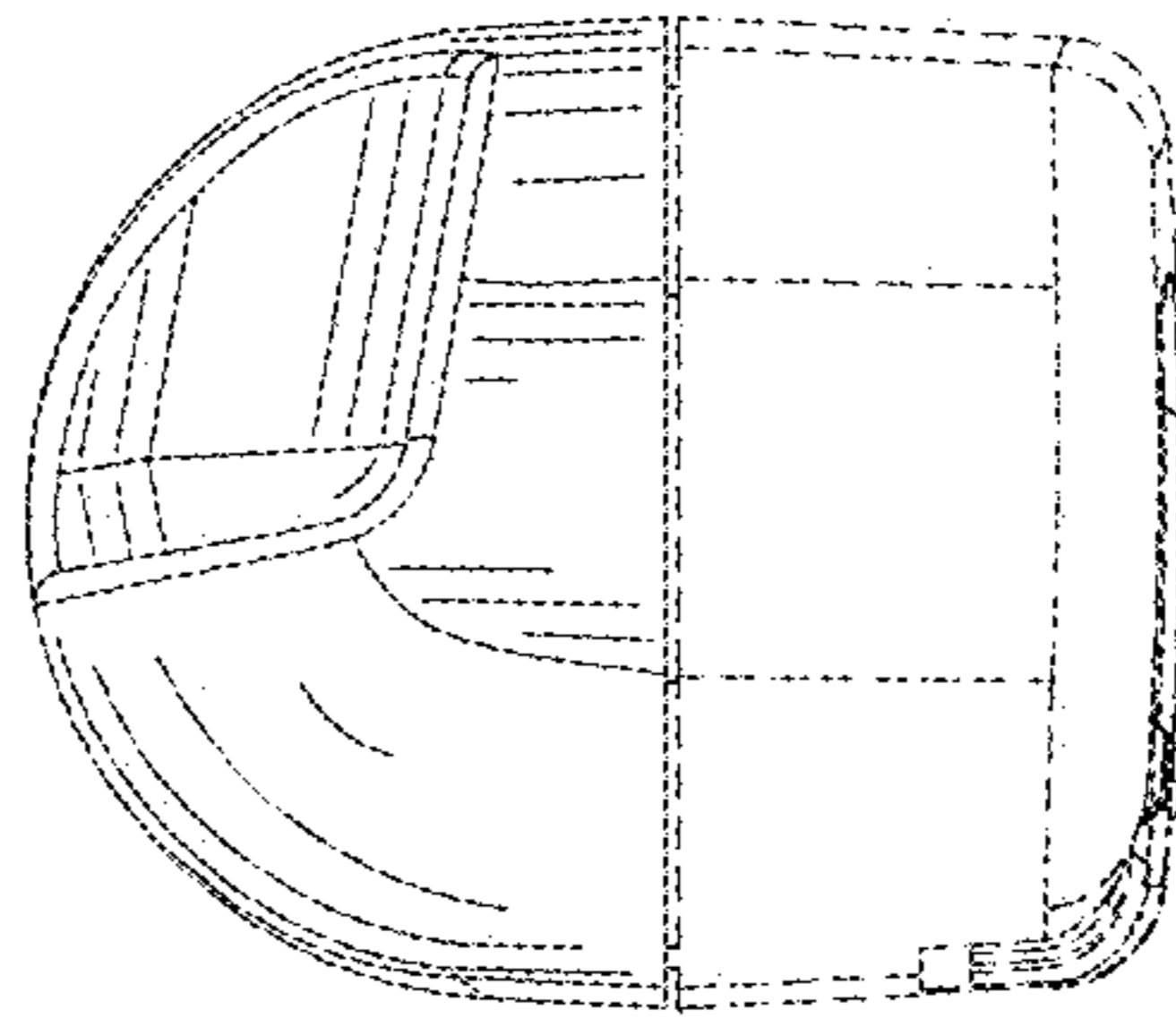

FIG. 9

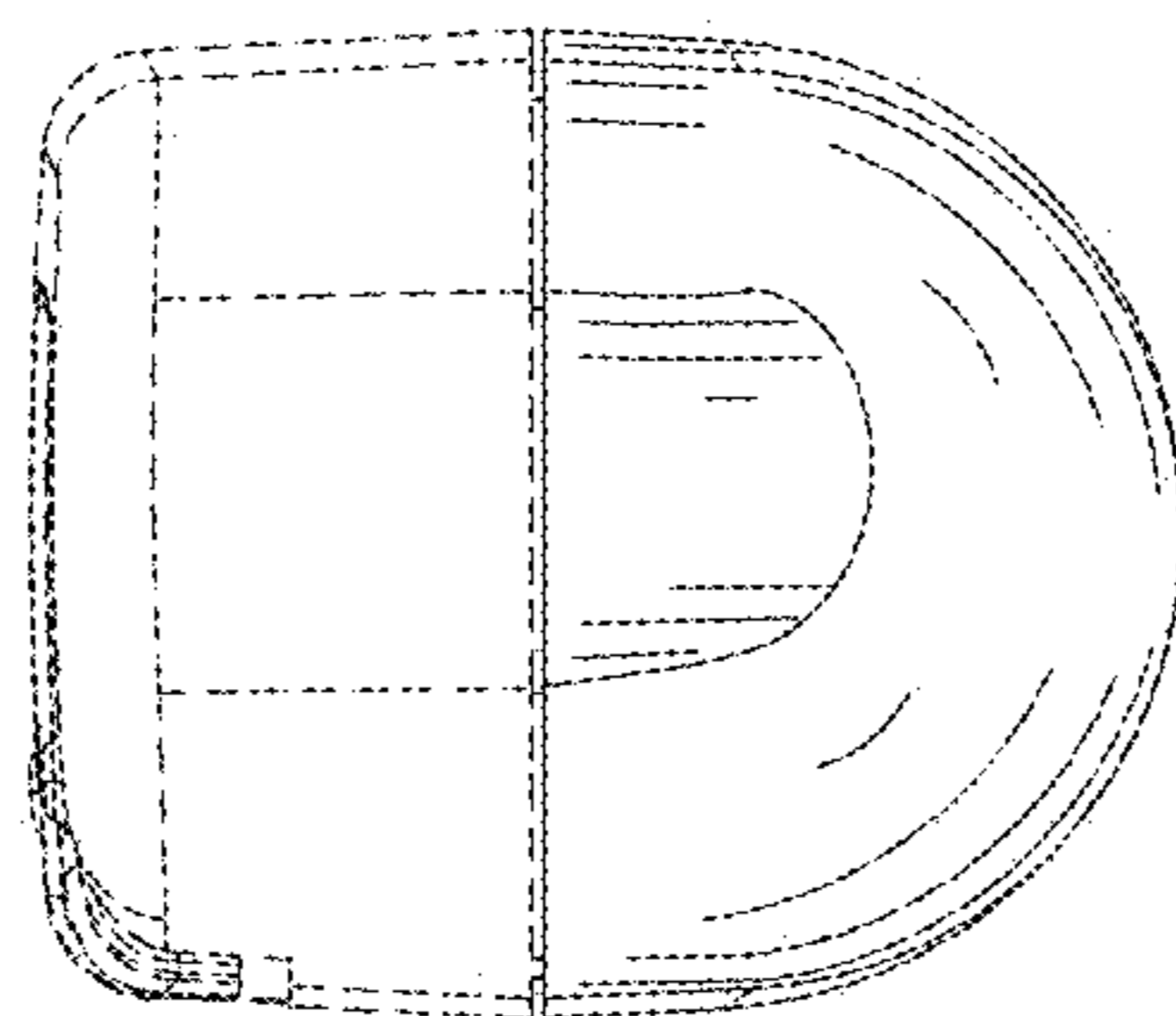

FIG. 10

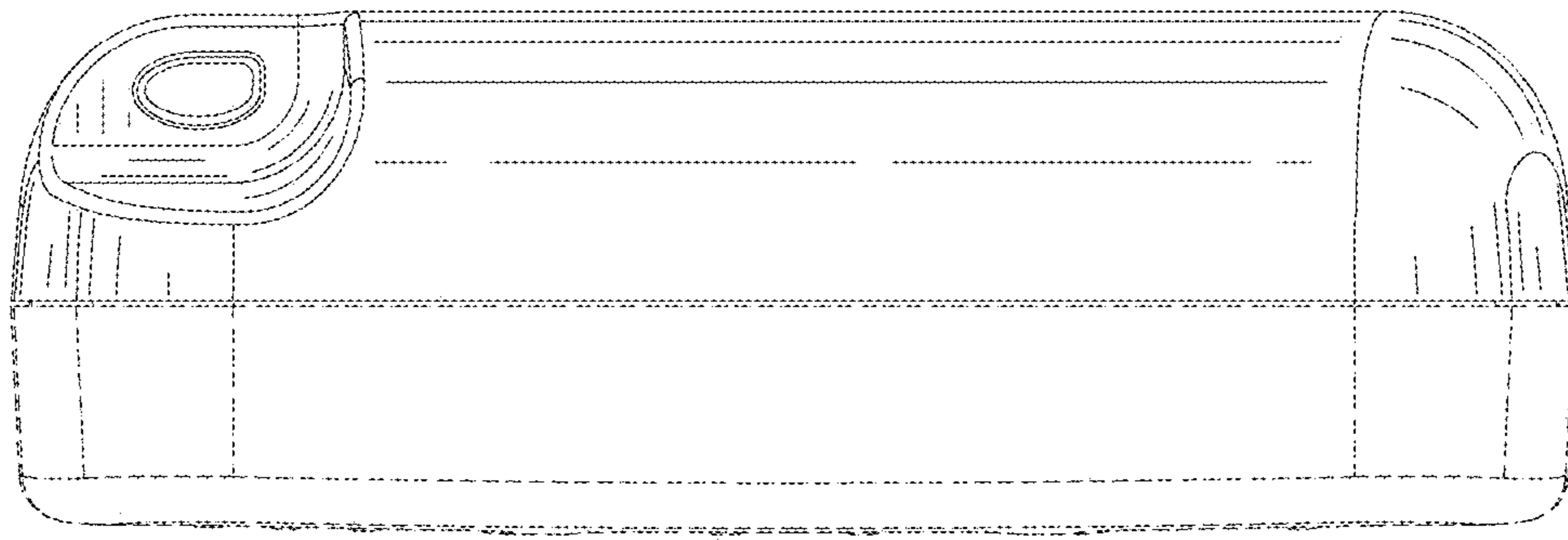

FIG. 11

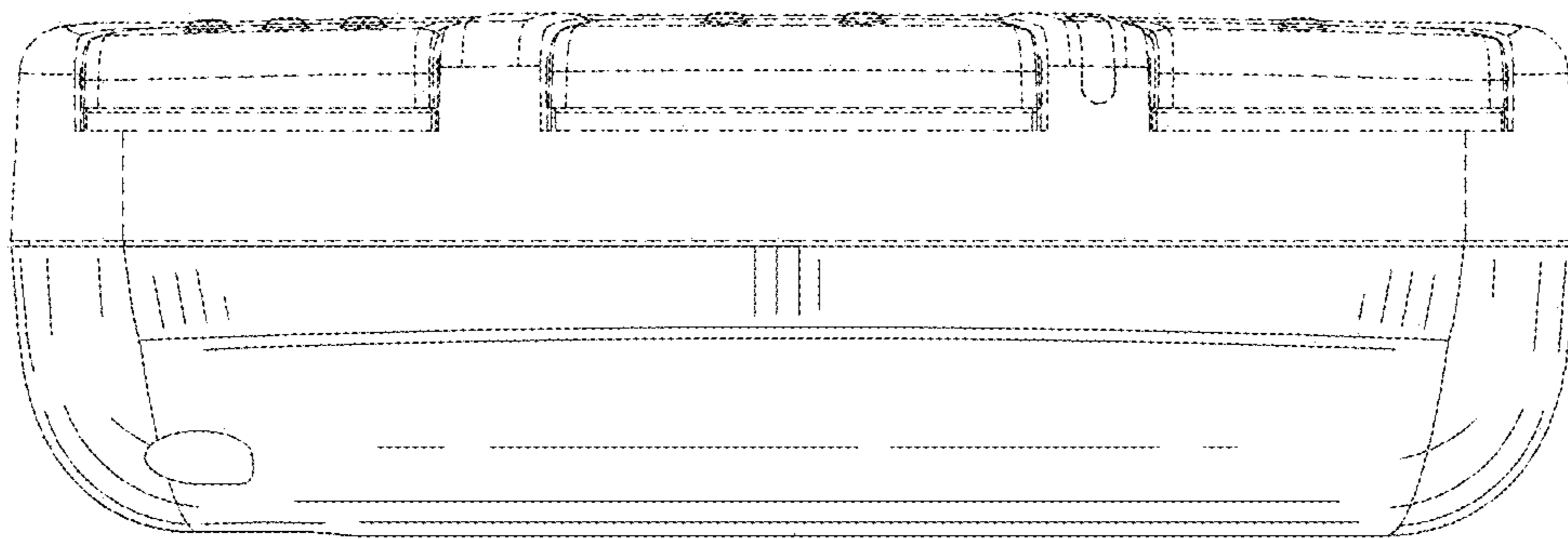

FIG. 12

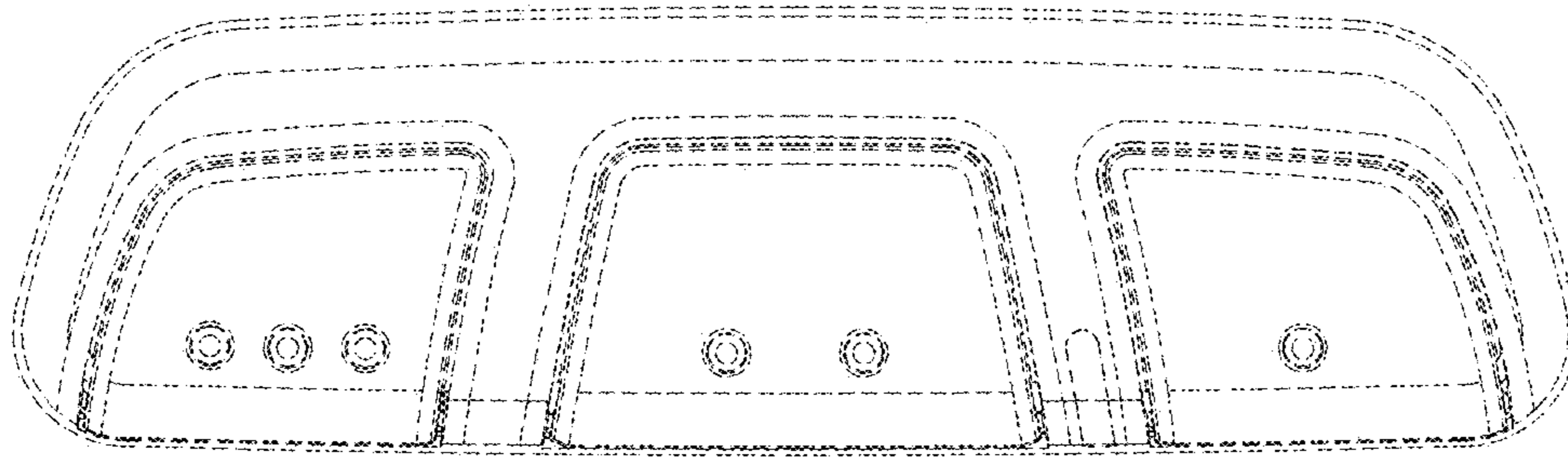

FIG. 13

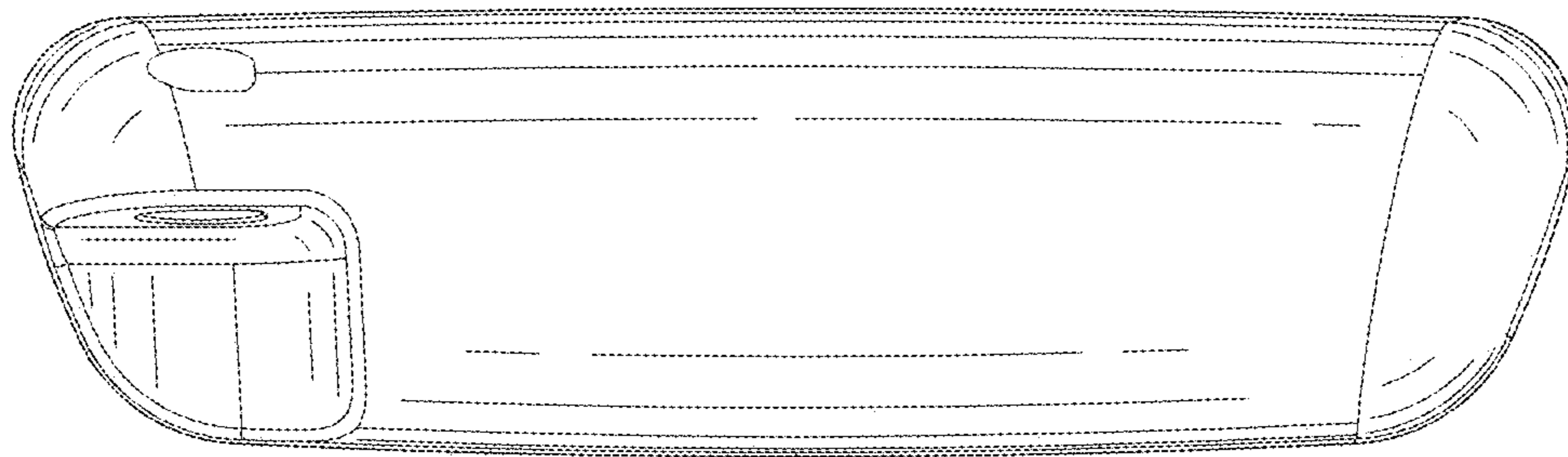

FIG. 14