



US00D898634S

(12) **United States Design Patent** (10) **Patent No.:** **US D898,634 S**
Patel (45) **Date of Patent:** **** Oct. 13, 2020**

(54) **FRONT BUMPER FOR A VEHICLE**
(71) Applicant: **Jaguar Land Rover Limited**, Whitley, Coventry (GB)
(72) Inventor: **Paven Patel**, Whitley Coventry (GB)
(73) Assignee: **Jaguar Land Rover Limited**, Whitley Coventry (GB)

(**) Term: **15 Years**
(21) Appl. No.: **29/687,703**
(22) Filed: **Apr. 15, 2019**

(30) **Foreign Application Priority Data**

Oct. 25, 2018 (EM) 005808441

(51) **LOC (12) Cl.** **12-16**

(52) **U.S. Cl.**
USPC **D12/169**

(58) **Field of Classification Search**
USPC D12/169, 164, 196, 171, 163, 86, 90-92;
293/102, 113, 115, 117, 120; 296/180.1,
296/180.2

CPC B60R 19/02; B60R 19/04; B62D 25/08
See application file for complete search history.

(56) **References Cited**

U.S. PATENT DOCUMENTS

D746,733 S * 1/2016 Behmer D12/169
D747,243 S * 1/2016 Patel D12/169
D779,396 S * 2/2017 Patel D12/169
D784,215 S * 4/2017 Peat D12/169
D801,887 S * 11/2017 Peat D12/169
D820,741 S * 6/2018 Patel D12/169

D837,109 S * 1/2019 Kozub D12/169
D840,295 S * 2/2019 Peat D12/169
D847,048 S * 4/2019 Patel D12/169
D855,511 S * 8/2019 Smith D12/169

* cited by examiner

Primary Examiner — Melody N Brown

(74) *Attorney, Agent, or Firm* — Wood Herron & Evans LLP

(57) **CLAIM**

The ornamental design for a front bumper for a vehicle, as shown and described.

DESCRIPTION

FIG. 1 is a top, front and left side perspective view of a front bumper for a vehicle showing my new design;
FIG. 2 is a left, front perspective view thereof;
FIG. 3 is a top, rear and right side perspective view thereof;
FIG. 4 is a right, rear perspective view thereof;
FIG. 5 is a front elevational view thereof;
FIG. 6 is a rear elevational view thereof;
FIG. 7 is a left side elevational view thereof;
FIG. 8 is a right side elevational view thereof;
FIG. 9 is a top plan view thereof;
FIG. 10 is a bottom plan view thereof; and,
FIG. 11 is another front elevational view thereof shown on a vehicle.

The portions of the vehicle shown in the FIG. 11 drawing view in a de-emphasized and half-tone form outside the broken lines and the broken lines representing the boundary and configuration of what is claimed as the design are all for environmental and illustrative purposes only and form no part of the claimed design.

1 Claim, 11 Drawing Sheets

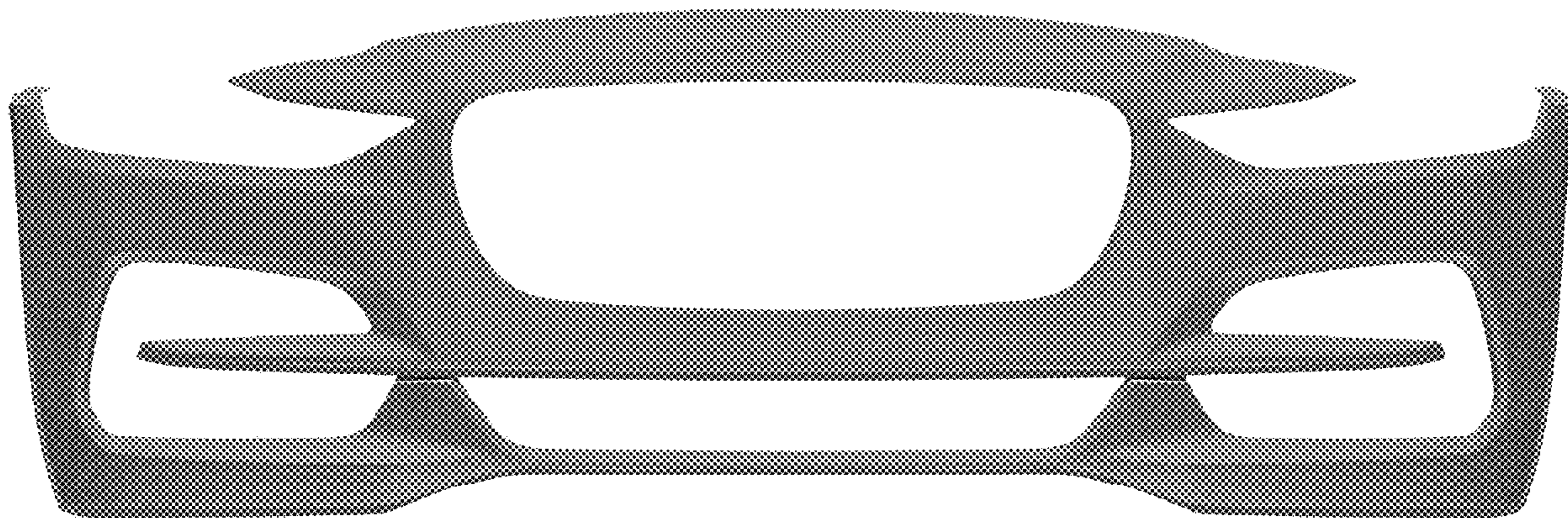

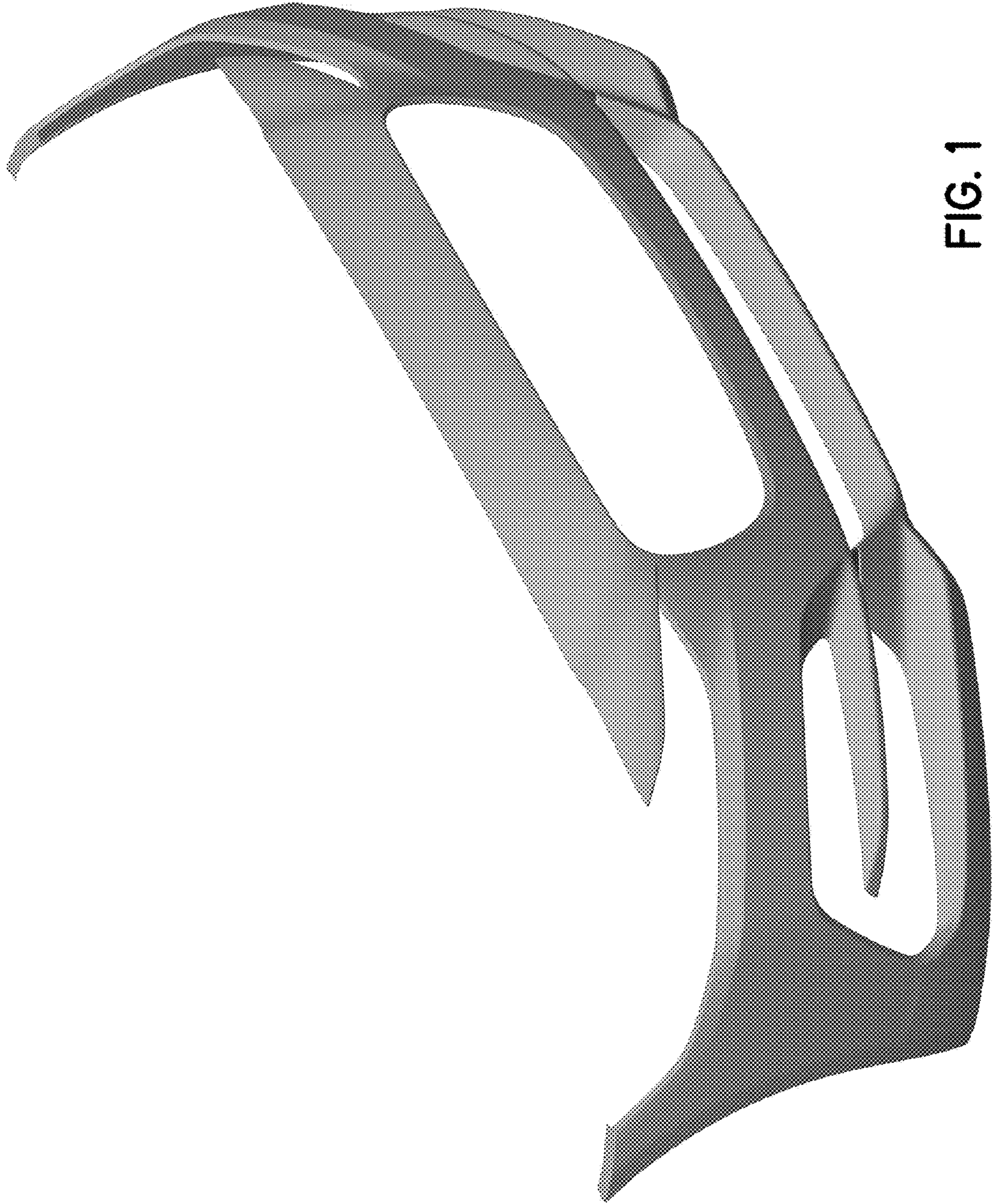

FIG. 1

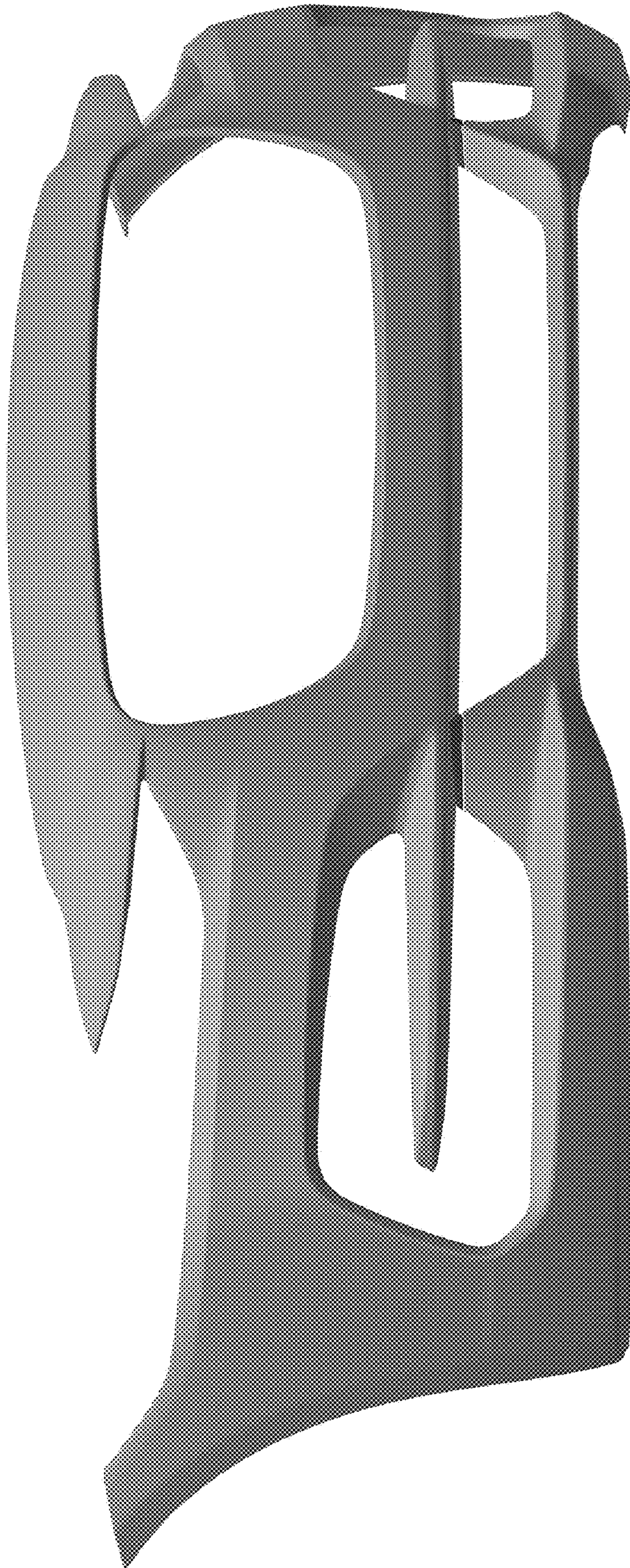

FIG. 2



FIG. 3

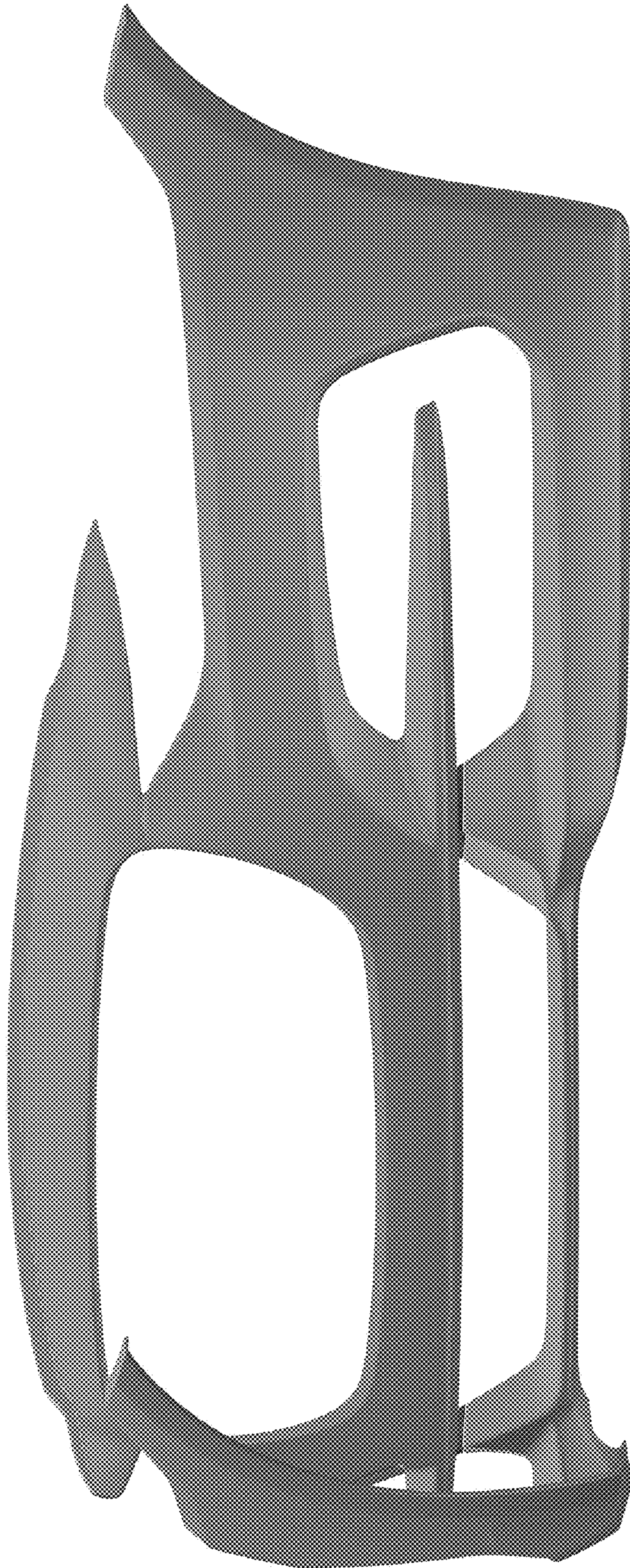

FIG. 4

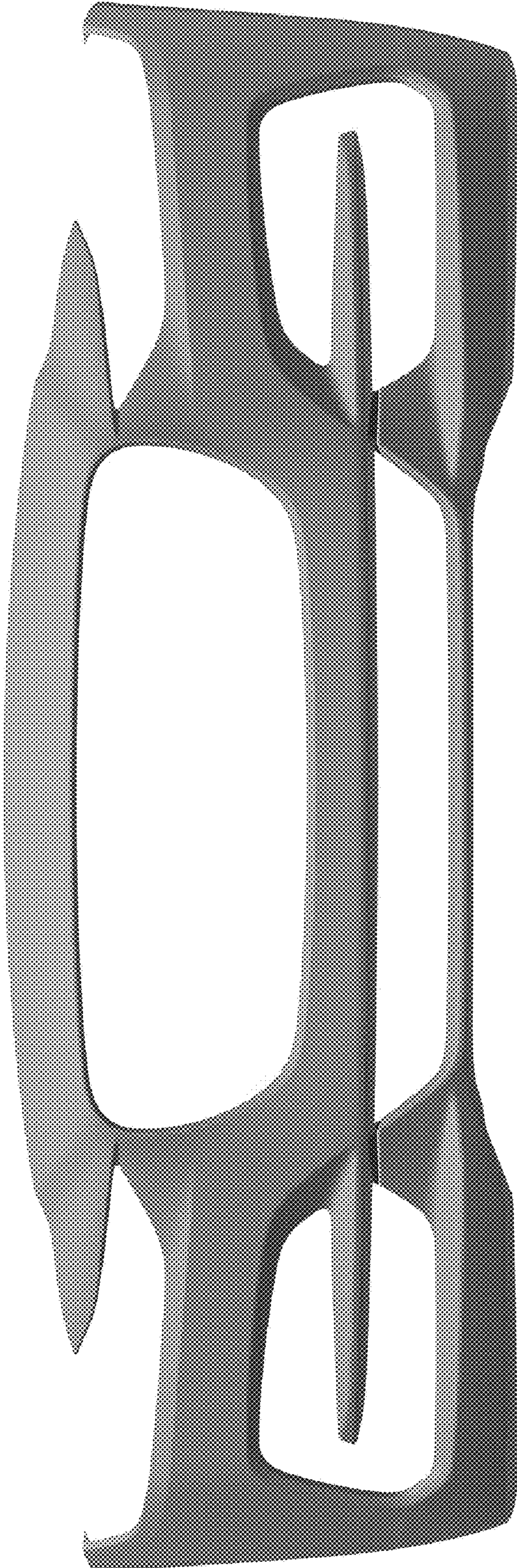

FIG. 5

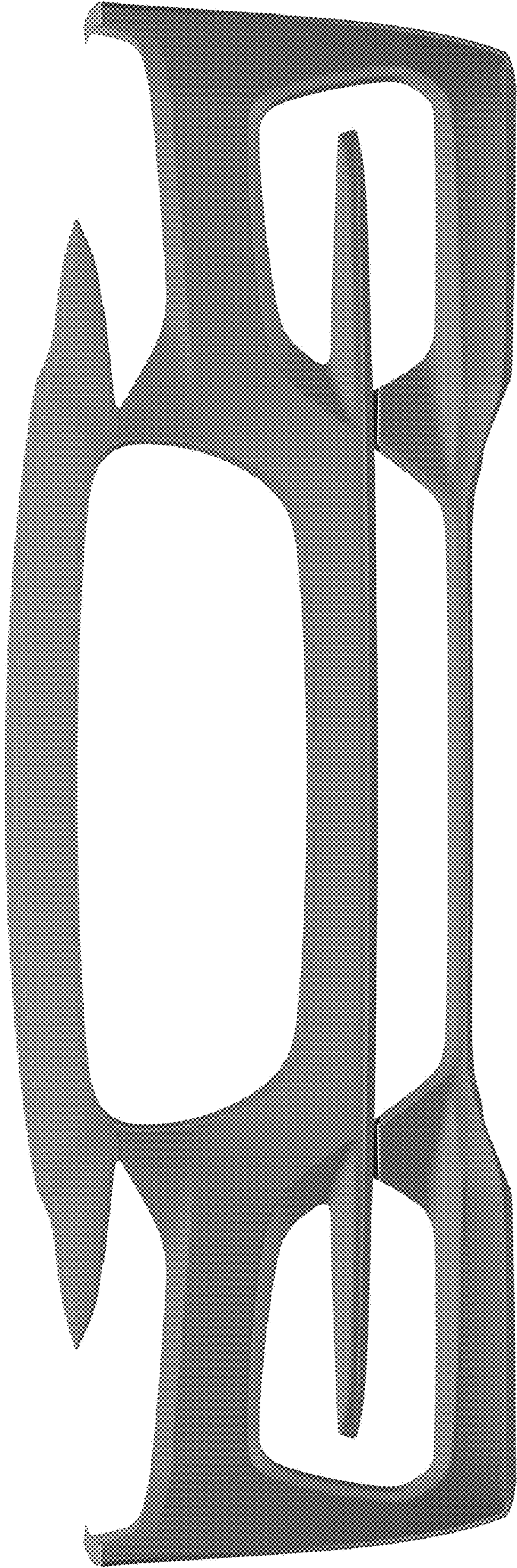

FIG. 6

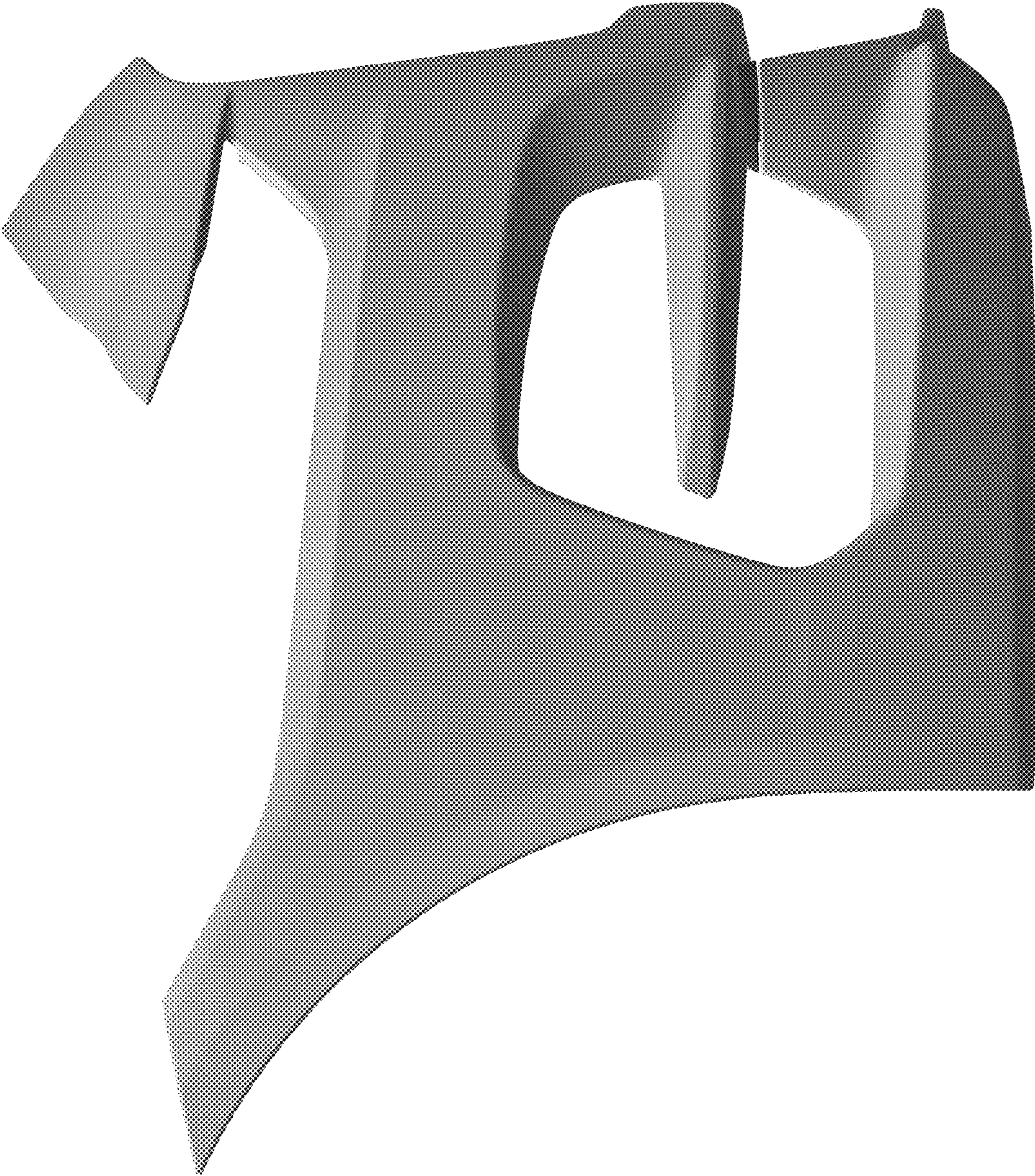

FIG. 7

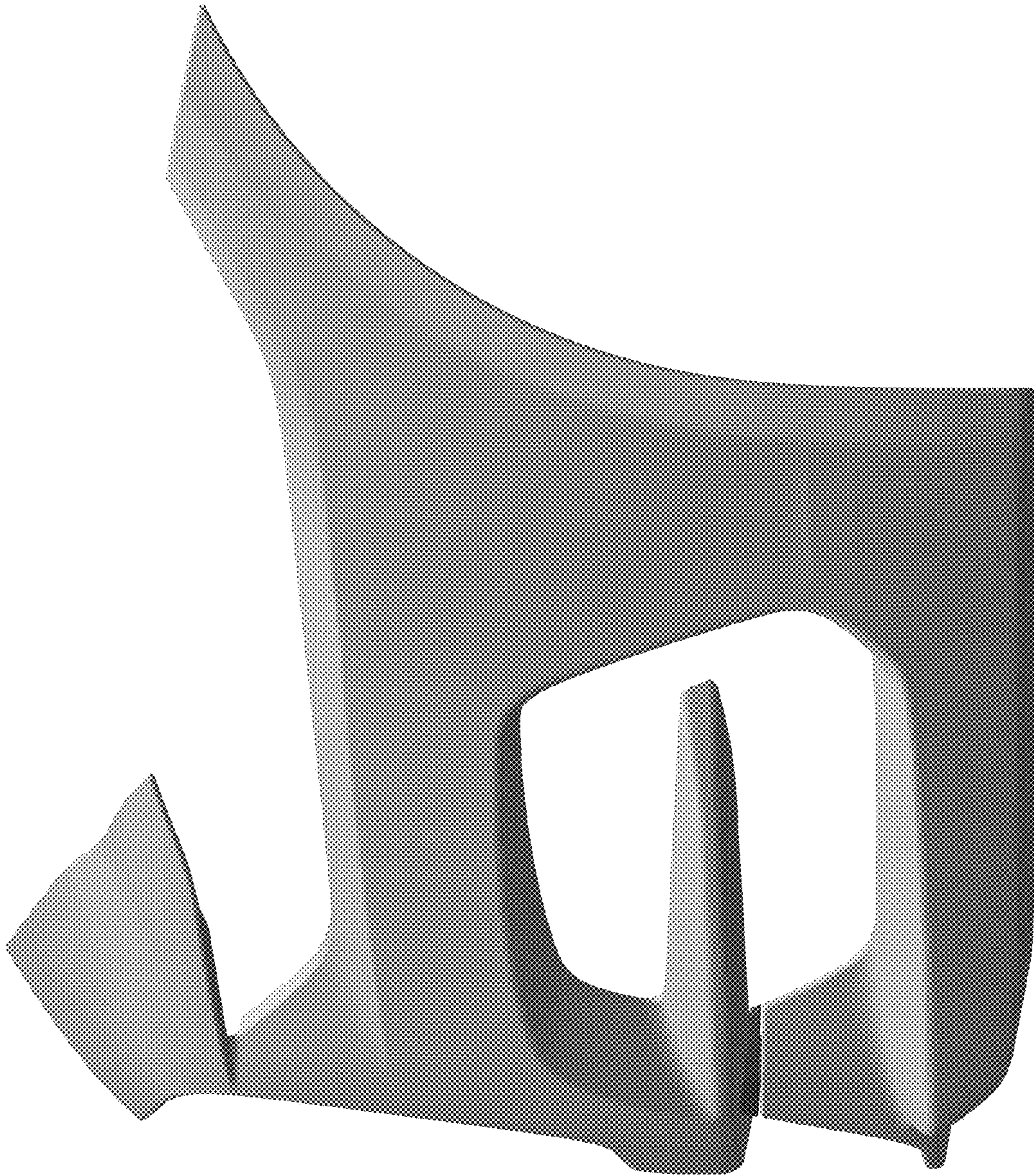

FIG. 8

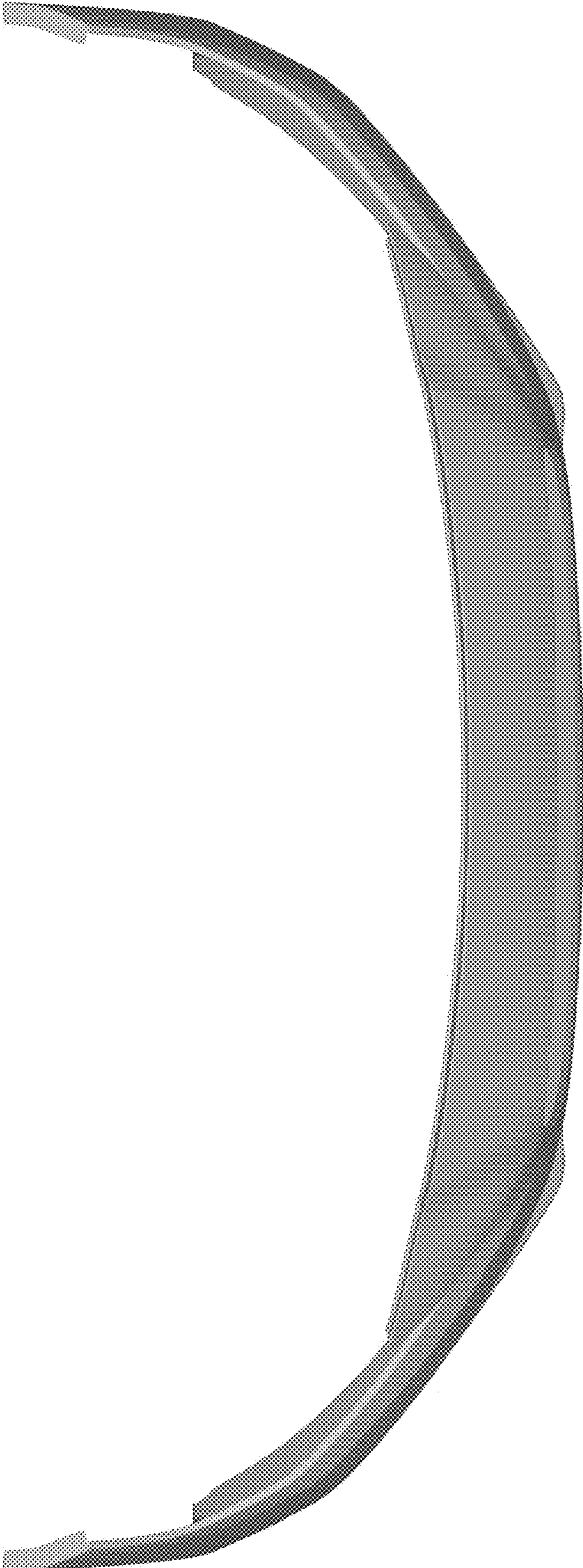

FIG. 9

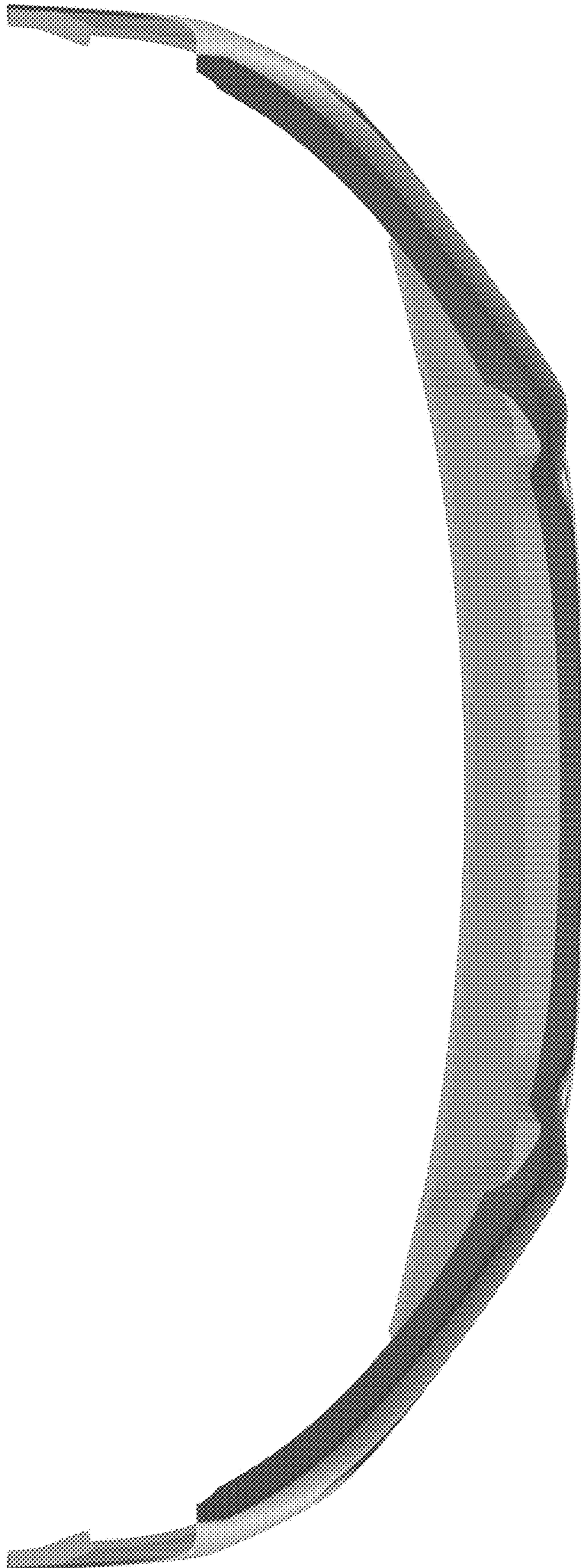

FIG. 10

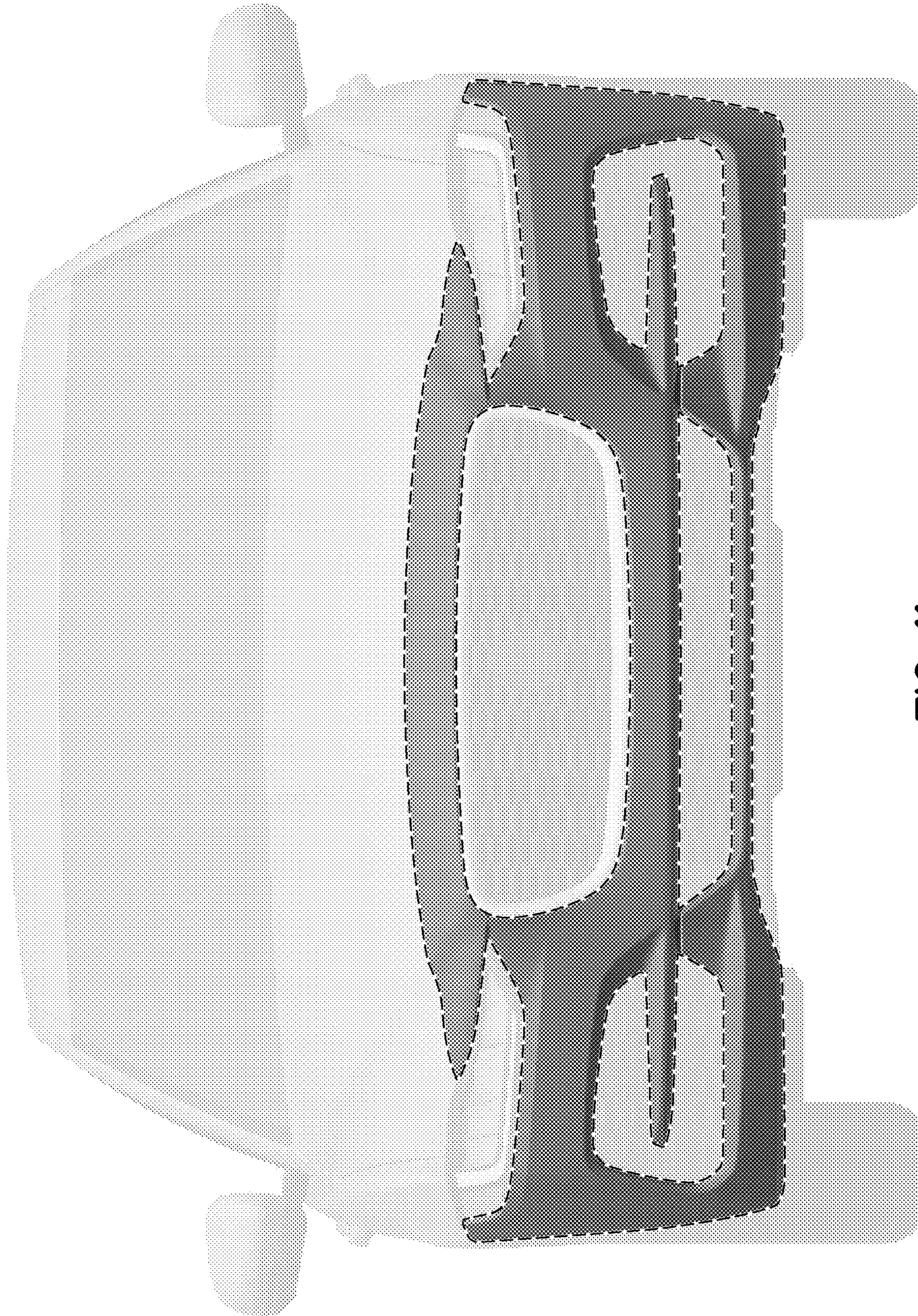

FIG. 11