



US00D898622S

(12) **United States Design Patent**
Wittinger

(10) **Patent No.:** **US D898,622 S**
(45) **Date of Patent:** **** Oct. 13, 2020**

(54) **VEHICLE, TOY, AND/OR REPLICAS THEREOF**

(71) Applicant: **Daimler AG**, Stuttgart (DE)

(72) Inventor: **Csaba Wittinger**, Ludwigsburg (DE)

(73) Assignee: **Daimler AG**, Stuttgart (DE)

(**) Term: **15 Years**

(21) Appl. No.: **29/725,944**

(22) Filed: **Feb. 28, 2020**

(30) **Foreign Application Priority Data**

Sep. 2, 2019 (DE) 40 2019 202 802

(51) **LOC (12) Cl.** **12-08**

(52) **U.S. Cl.**
USPC **D12/92**

(58) **Field of Classification Search**
USPC D12/86, 90-92, 88; D21/424, 433, 434,
D21/533; 296/181.1-181.5, 183.1
CPC B62D 25/00; B62D 25/06; B62D 33/00;
B62D 35/00
See application file for complete search history.

(56) **References Cited**

U.S. PATENT DOCUMENTS

D813,726 S *	3/2018	Tanghe	D12/91
D813,727 S *	3/2018	Beermann	D12/92
D821,919 S *	7/2018	Simm	D12/91
D825,383 S *	8/2018	Luk	D12/91
D825,390 S *	8/2018	Al Attar	D12/92
D826,783 S *	8/2018	Badstuebner	D12/92
D827,497 S *	9/2018	Frei	D12/91

D827,514 S *	9/2018	Badstuebner	D12/164
D831,540 S *	10/2018	Buckingham	D12/92
D836,490 S *	12/2018	Futschik	D12/92
D837,692 S *	1/2019	Badstuebner	D12/91
D862,287 S *	10/2019	Badstuebner	D12/91
D873,715 S *	1/2020	Badstuebner	D12/91
D873,716 S *	1/2020	Badstuebner	D12/91
D886,679 S *	6/2020	Hellwig	D12/91
D888,623 S *	6/2020	Vidojkovic	D12/164

FOREIGN PATENT DOCUMENTS

EM	005237864-0001	4/2018
EM	005237864-0002	4/2018

* cited by examiner

Primary Examiner — Melody N Brown

(74) *Attorney, Agent, or Firm* — Crowell & Moring LLP

(57) **CLAIM**

The ornamental design for a vehicle, toy, and/or replicas thereof, as shown and described.

DESCRIPTION

FIG. 1 is a left, front perspective view of a vehicle, toy, and/or replicas thereof according to the design;
FIG. 2 is a left, rear perspective view thereof;
FIG. 3 is a front view thereof;
FIG. 4 is a rear view thereof;
FIG. 5 is a left side view thereof; and,
FIG. 6 is a right side view thereof.
The broken lines in the drawings illustrate environmental subject matter only and form no part of the claimed design.

1 Claim, 6 Drawing Sheets

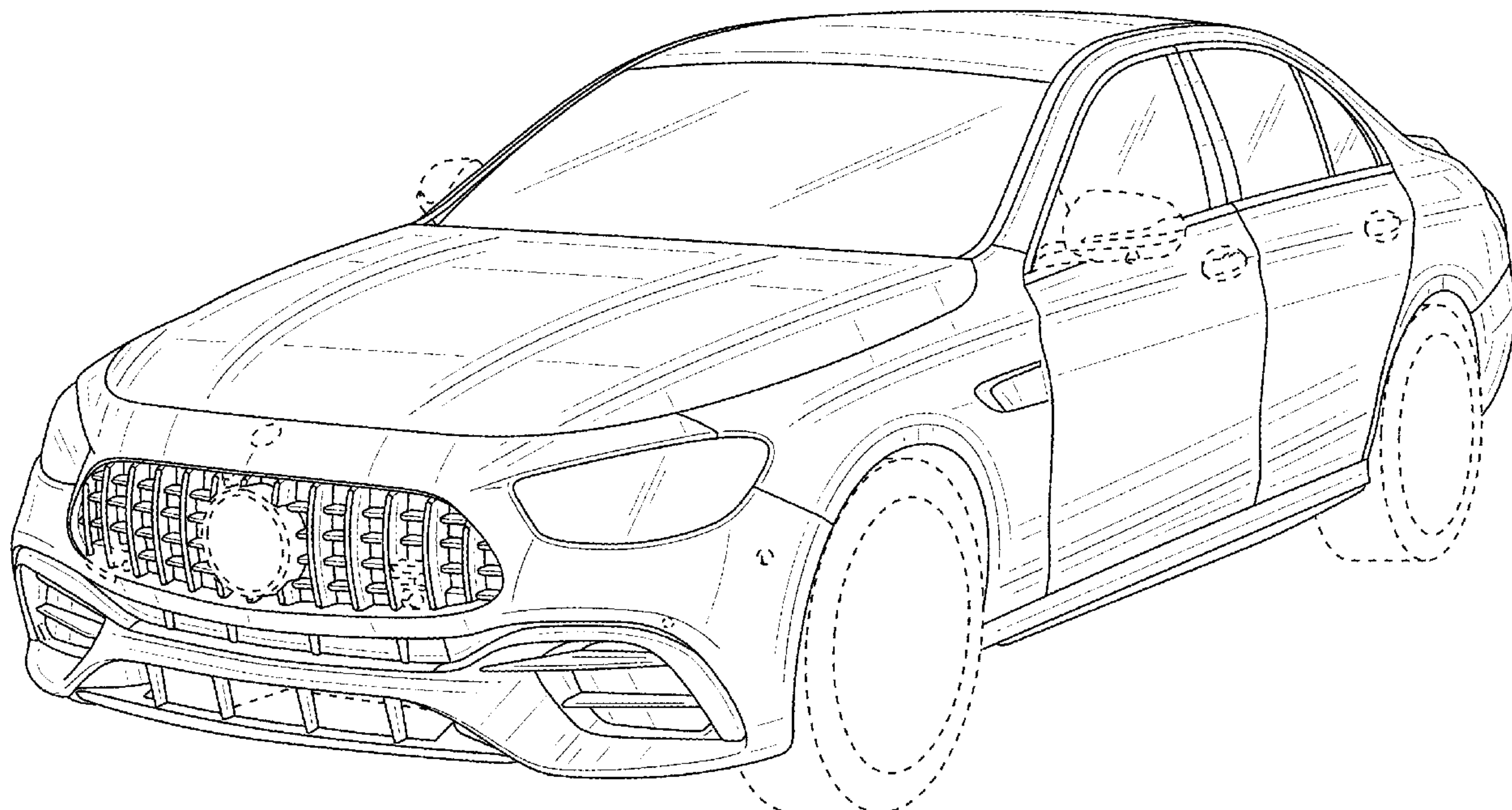

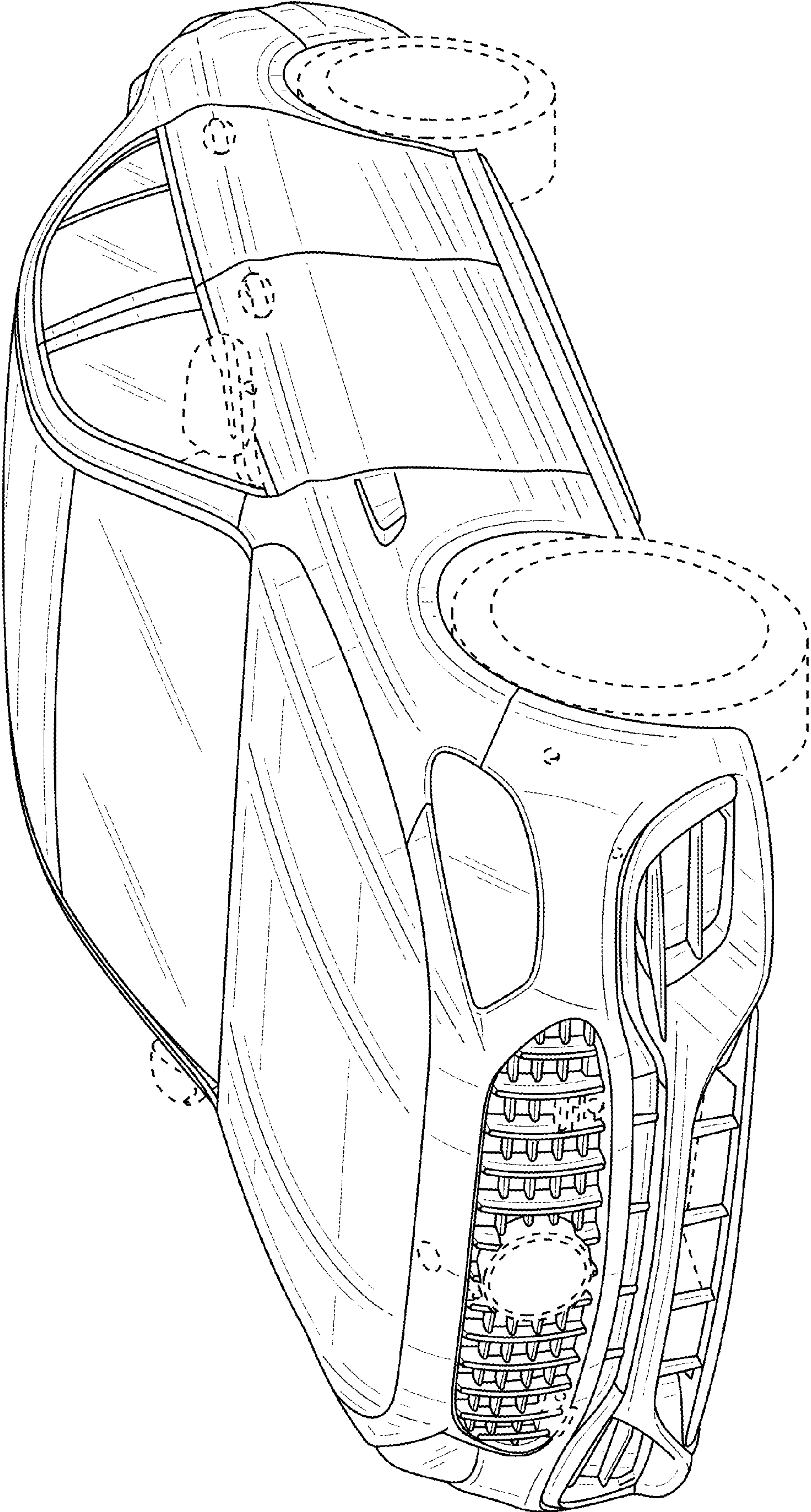

FIG. 1

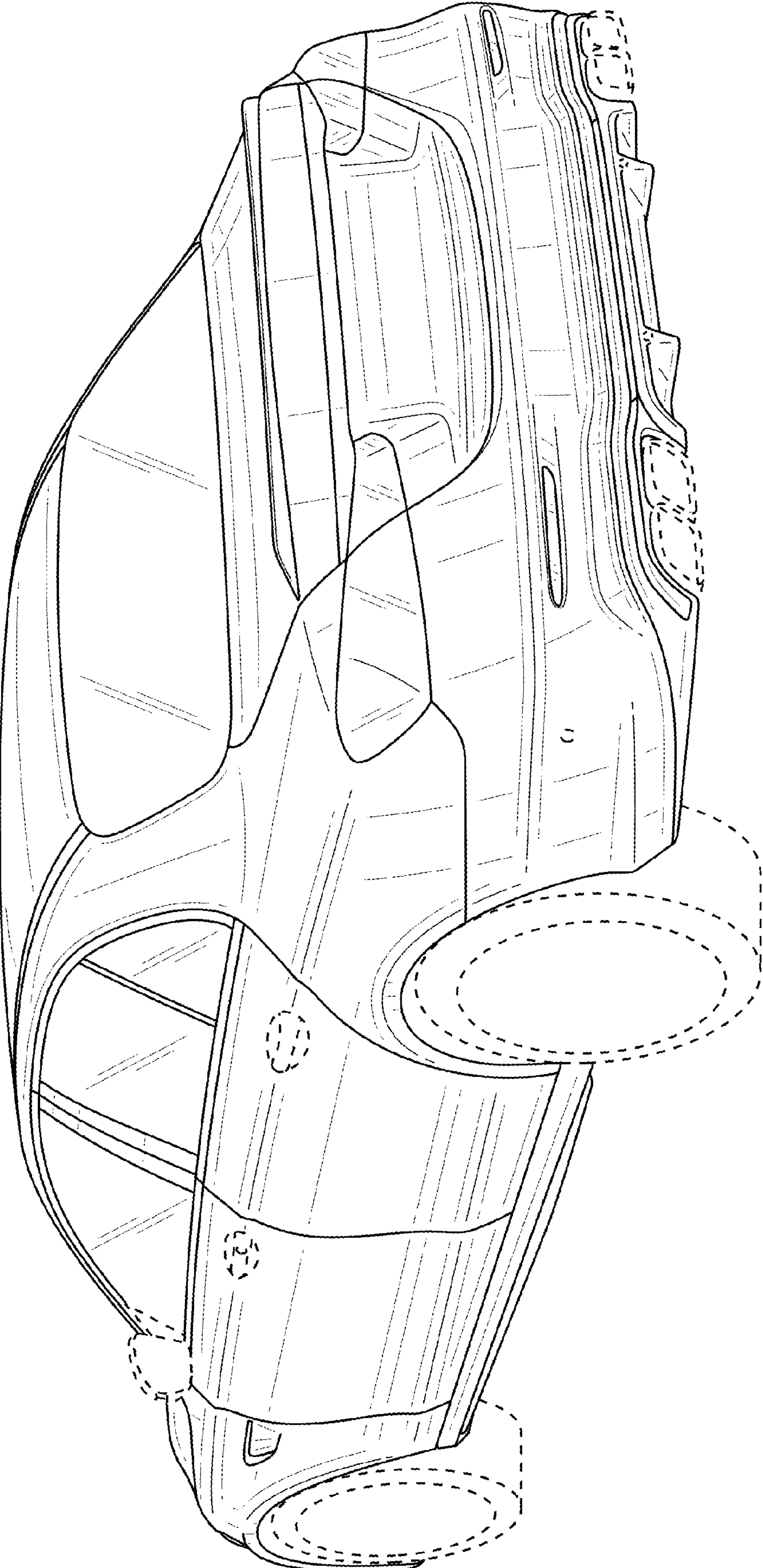

FIG. 2

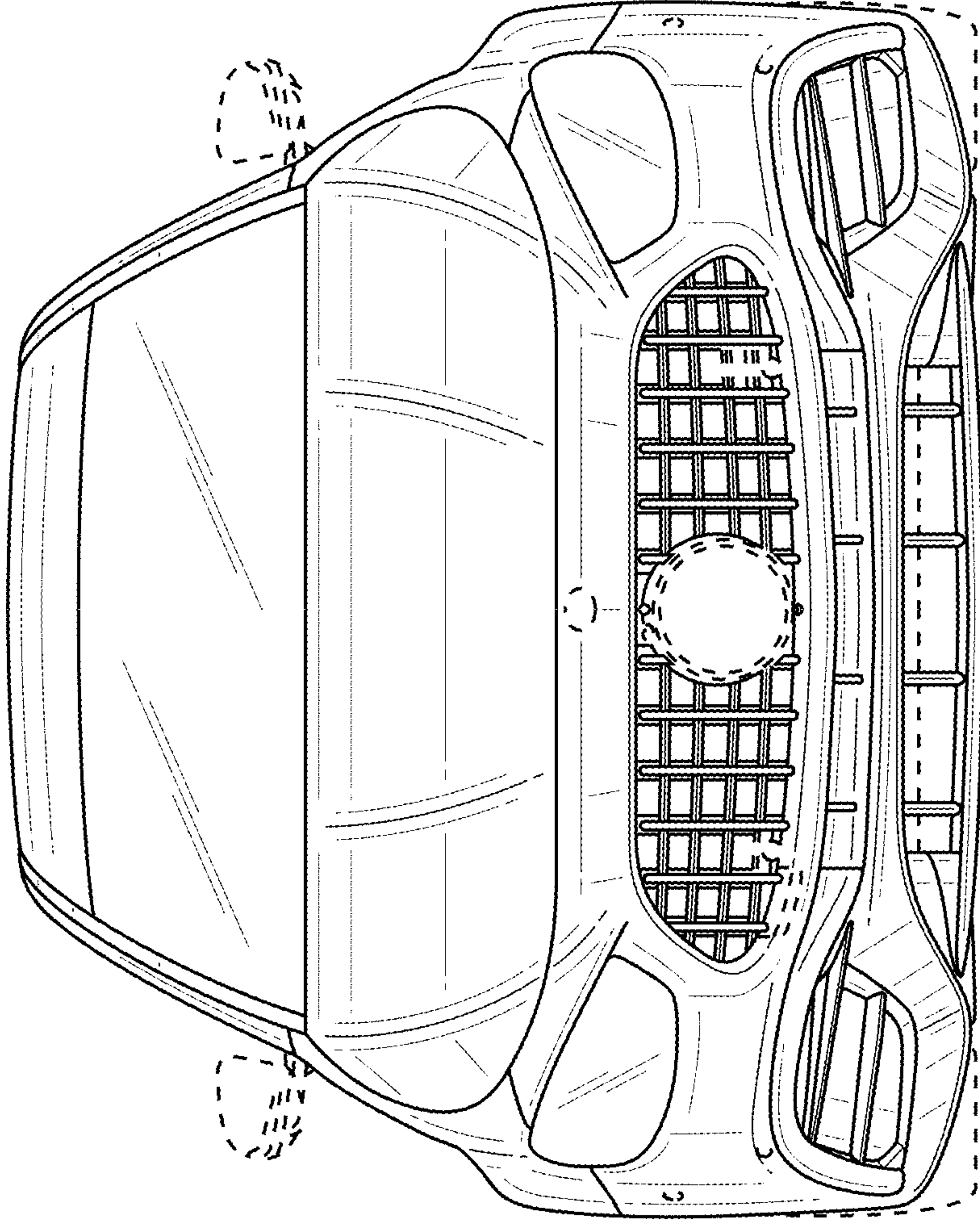

FIG. 3

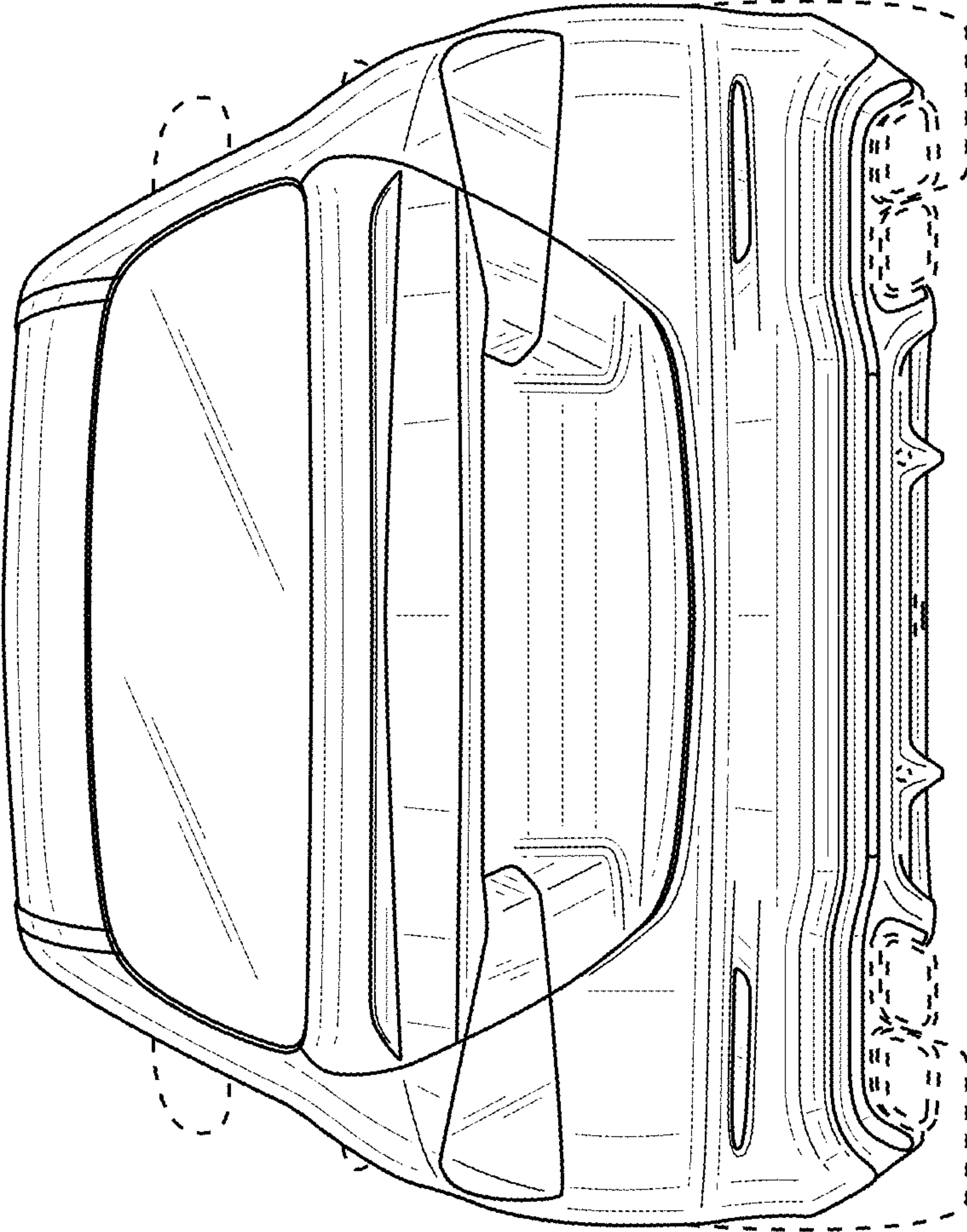

FIG. 4

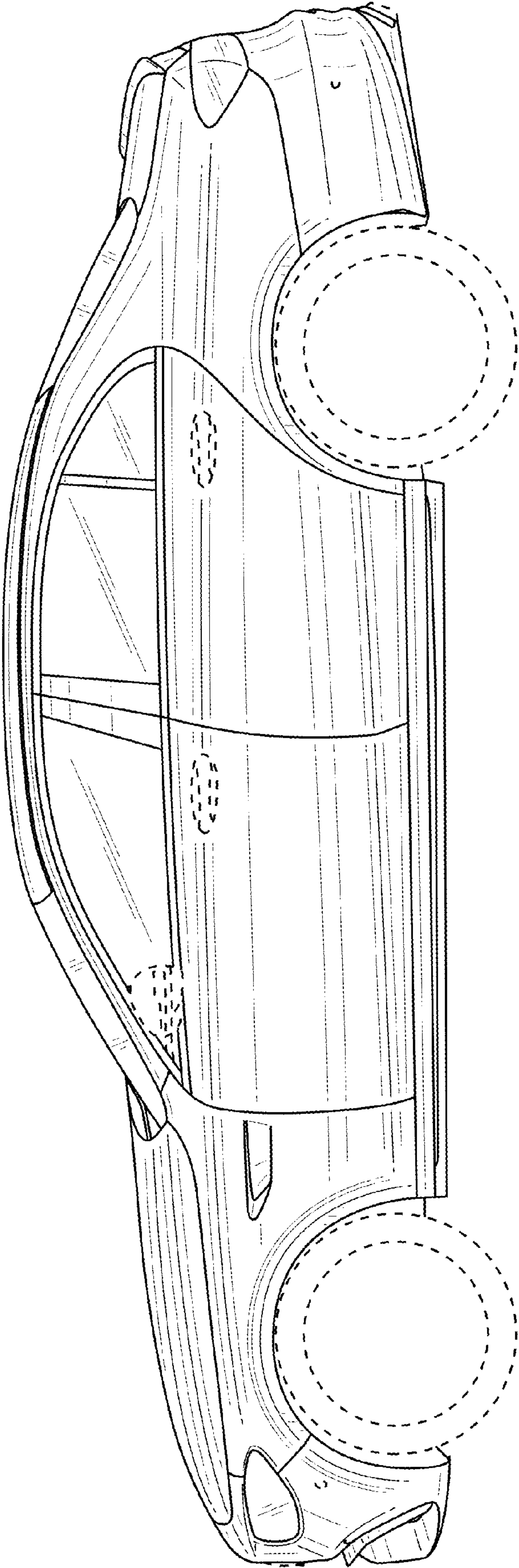

FIG. 5

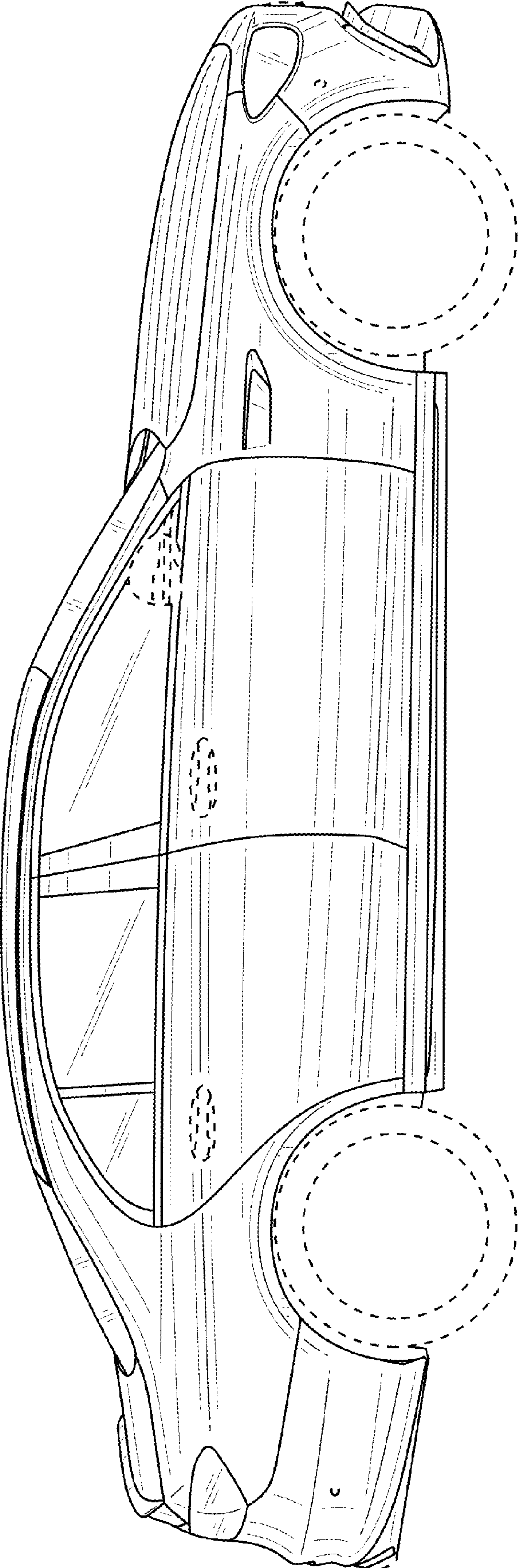

FIG. 6