



US00D898504S

(12) **United States Design Patent**
Huckestein et al.

(10) **Patent No.:** **US D898,504 S**
(45) **Date of Patent:** **** Oct. 13, 2020**

(54) **EGG BOILING TRAY**

(71) Applicants: **William Huckestein**, Ventura, CA (US); **Scott Kim**, Ventura, CA (US); **Giovanni Manaloto Rodriguez**, Ventura, CA (US)

(72) Inventors: **William Huckestein**, Ventura, CA (US); **Scott Kim**, Ventura, CA (US); **Giovanni Manaloto Rodriguez**, Ventura, CA (US)

(**) Term: **15 Years**

(21) Appl. No.: **29/694,877**

(22) Filed: **Jun. 13, 2019**

(51) **LOC (12) Cl.** **07-02**

(52) **U.S. Cl.**

USPC **D7/357**

(58) **Field of Classification Search**

USPC D7/354, 355, 356, 357, 359, 501, 503, D7/505, 550.1, 553.1, 553.2, 553.6, D7/553.7, 553.8, 554.1, 554.2, 554.3, D7/554.4, 753; D3/304; D9/736, 749, D9/755, 758, 760, 456; D1/105, 124
CPC .. A47J 29/00; A47J 29/02; A47J 29/04; A47J 29/06; A47J 27/004; A47J 36/027; A01K 41/06; A01K 41/065; B65D 85/32; B65D 85/321; B65D 85/322; B65D 85/324; B65G 2201/2208; A47G 19/282; F25D 2331/807

See application file for complete search history.

(56) **References Cited**

U.S. PATENT DOCUMENTS

D23,930 S * 1/1895 Kroeter D7/357
855,565 A * 6/1907 Greenhouse B65D 71/72
206/562
1,199,987 A * 10/1916 Husted A47G 33/02
206/19

(Continued)

FOREIGN PATENT DOCUMENTS

JP 2014161230 A * 9/2014

OTHER PUBLICATIONS

Flexzion Electric Egg Cooker & Poacher Maker, announced Mar. 12, 2018 [online], retrieved Jul. 29, 2020, retrieved from internet, <https://www.amazon.com/Flexzion-Stainless-Automatic-Attachment-Accessory/dp/B01MYTFORN>.*

(Continued)

Primary Examiner — Dana K Weiland
Assistant Examiner — Messina L Smith

(74) *Attorney, Agent, or Firm* — Quickpatents, LLC; Kevin Prince

(57) **CLAIM**

The ornamental design for an egg boiling tray, as shown and described.

DESCRIPTION

FIG. 1 is a top perspective view of an egg boiling tray, showing a first embodiment of our new design; FIG. 2 is a bottom perspective view of FIG. 1; FIG. 3 is a bottom plan view of FIG. 1; FIG. 4 is a top plan view of FIG. 1; FIG. 5 is an enlarged left-side elevational view of FIG. 1, the right-side elevational view, front elevational view, and rear elevational view all being identical thereto; FIG. 6 is a cross-sectional view thereof, taken in the direction of line 6-6 in FIG. 4; FIG. 7 is a top perspective view of a second embodiment thereof; FIG. 8 is a bottom perspective view of FIG. 7; FIG. 9 is a bottom plan view of FIG. 7; FIG. 10 is a top plan view of FIG. 7; FIG. 11 is an enlarged left-side elevational view of FIG. 7, the right-side elevational view, front elevational view, and rear elevational view all being identical thereto; and,

(Continued)

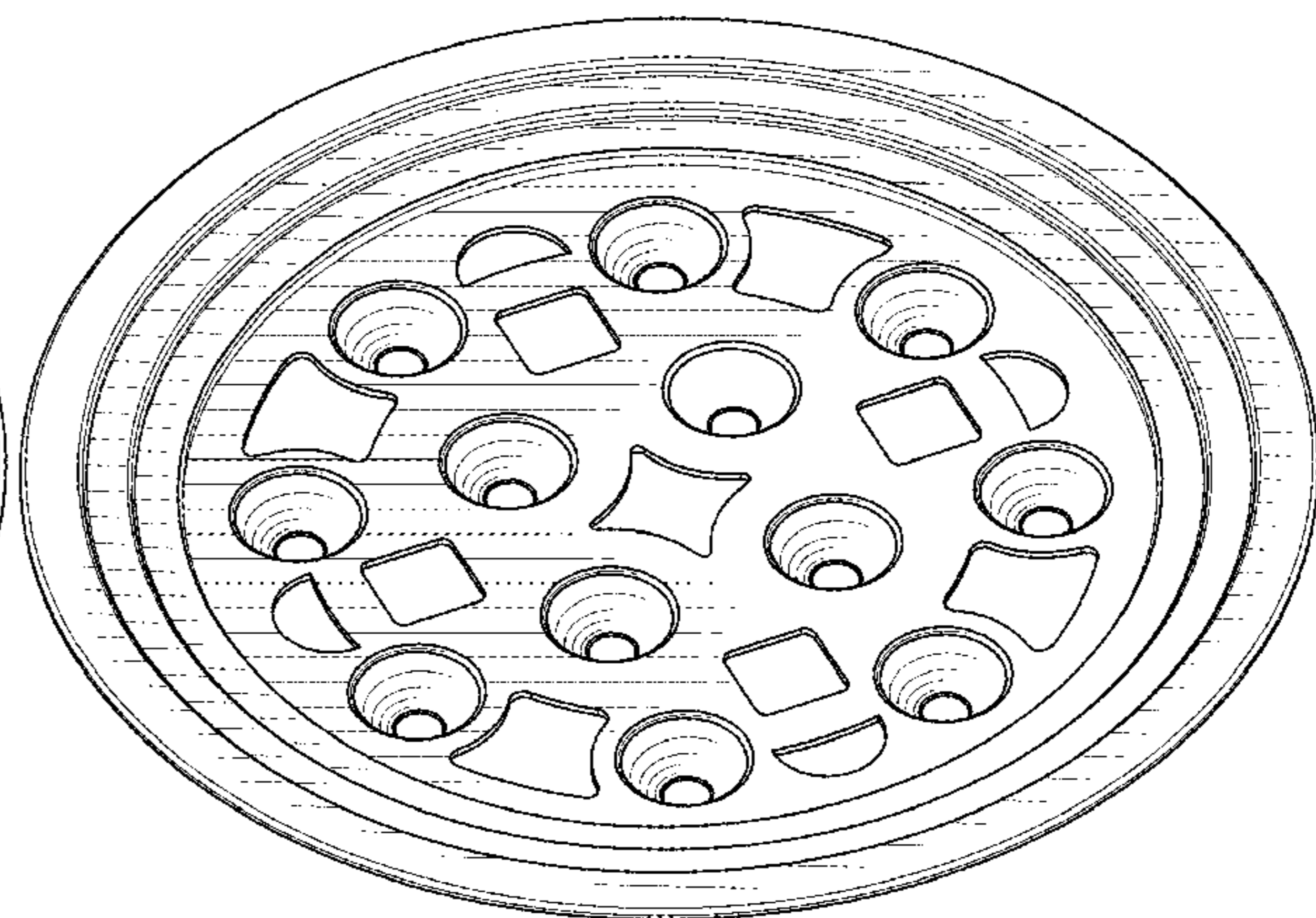
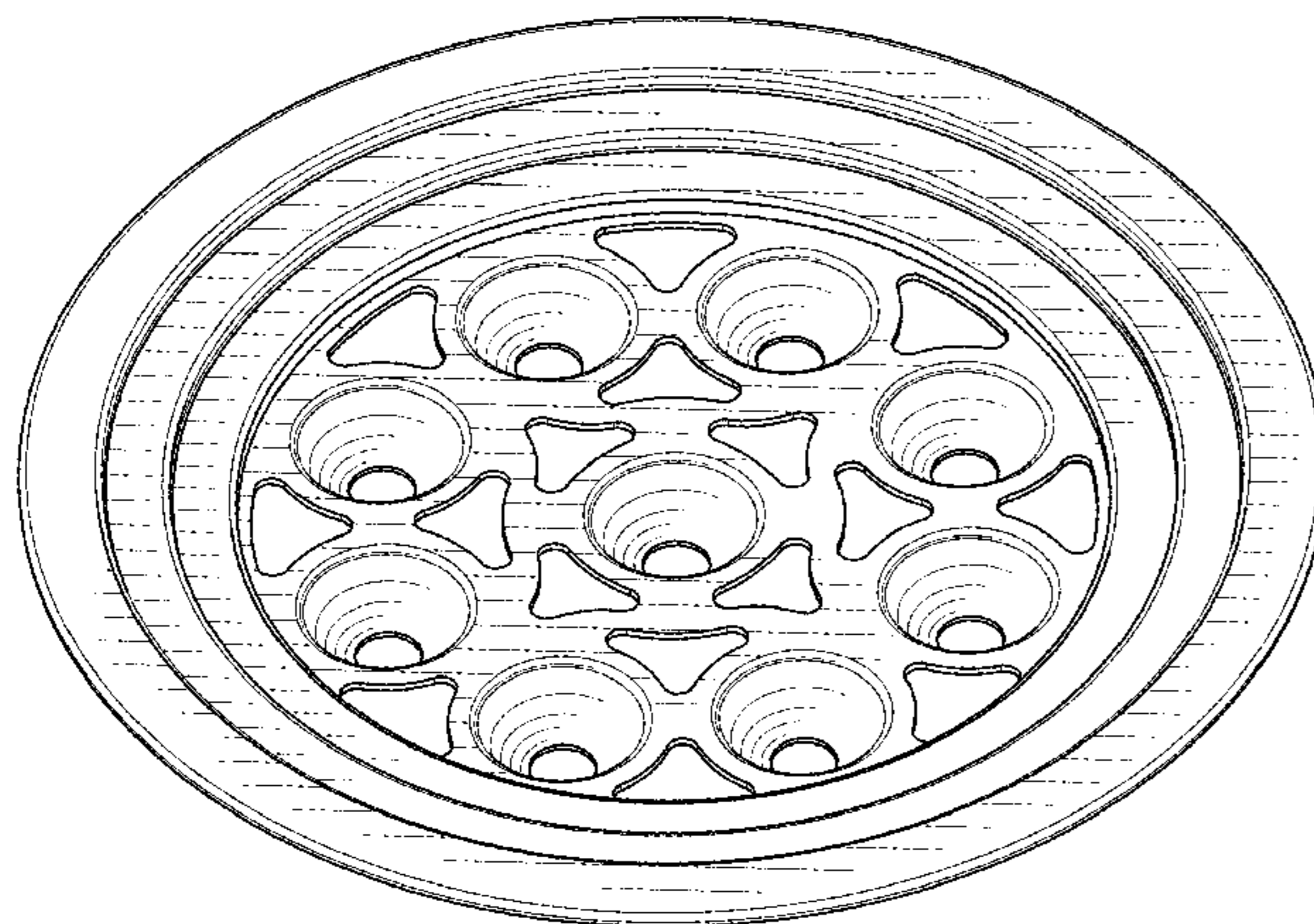

FIG. 12 is a cross-sectional view thereof, taken in the direction of line 12-12 in FIG. 10.

1 Claim, 10 Drawing Sheets

(56)

References Cited

U.S. PATENT DOCUMENTS

D252,066	S	*	6/1979	Jeambey	D7/357
D275,925	S	*	10/1984	Bowen	D7/357
D292,161	S	*	10/1987	Spolter	D7/553.6
D391,449	S	*	3/1998	Toth	D7/554.2
D393,775	S	*	4/1998	Otero	D7/553.6
D396,388	S	*	7/1998	Mishan	D7/672
D401,734	S	*	11/1998	Monk	D99/25
D469,653	S	*	2/2003	Cooper	D7/357
D497,077	S	*	10/2004	de Groote	D7/357
D533,407	S	*	12/2006	McMullin	D7/585
D655,567	S	*	3/2012	Kirkland	D7/357
D688,085	S	*	8/2013	Harris	D7/357
D696,896	S	*	1/2014	Weskamp	D7/357
D731,249	S	*	6/2015	Keeth	D7/554.2
D804,325	S	*	12/2017	Thompson	D9/758

OTHER PUBLICATIONS

2-Layer Rapid Egg Cooker Steamer Electric Egg Poacher Boiler, announced © 2010-2020 [online], retrieved Jul. 29, 2020, retrieved from internet, <https://www.aliexpress.com/i/33024501787.html>.*

* cited by examiner

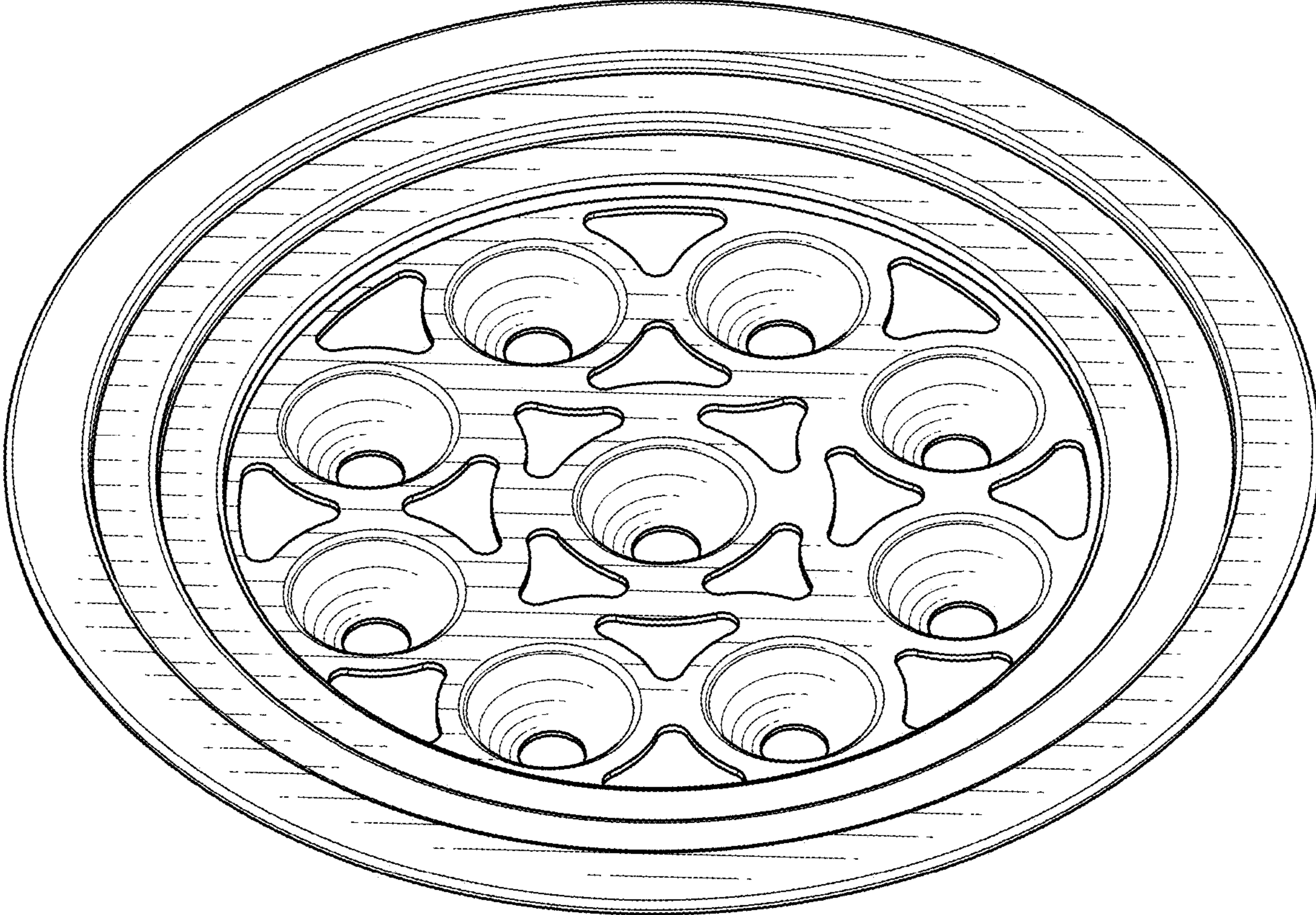

FIG. 1

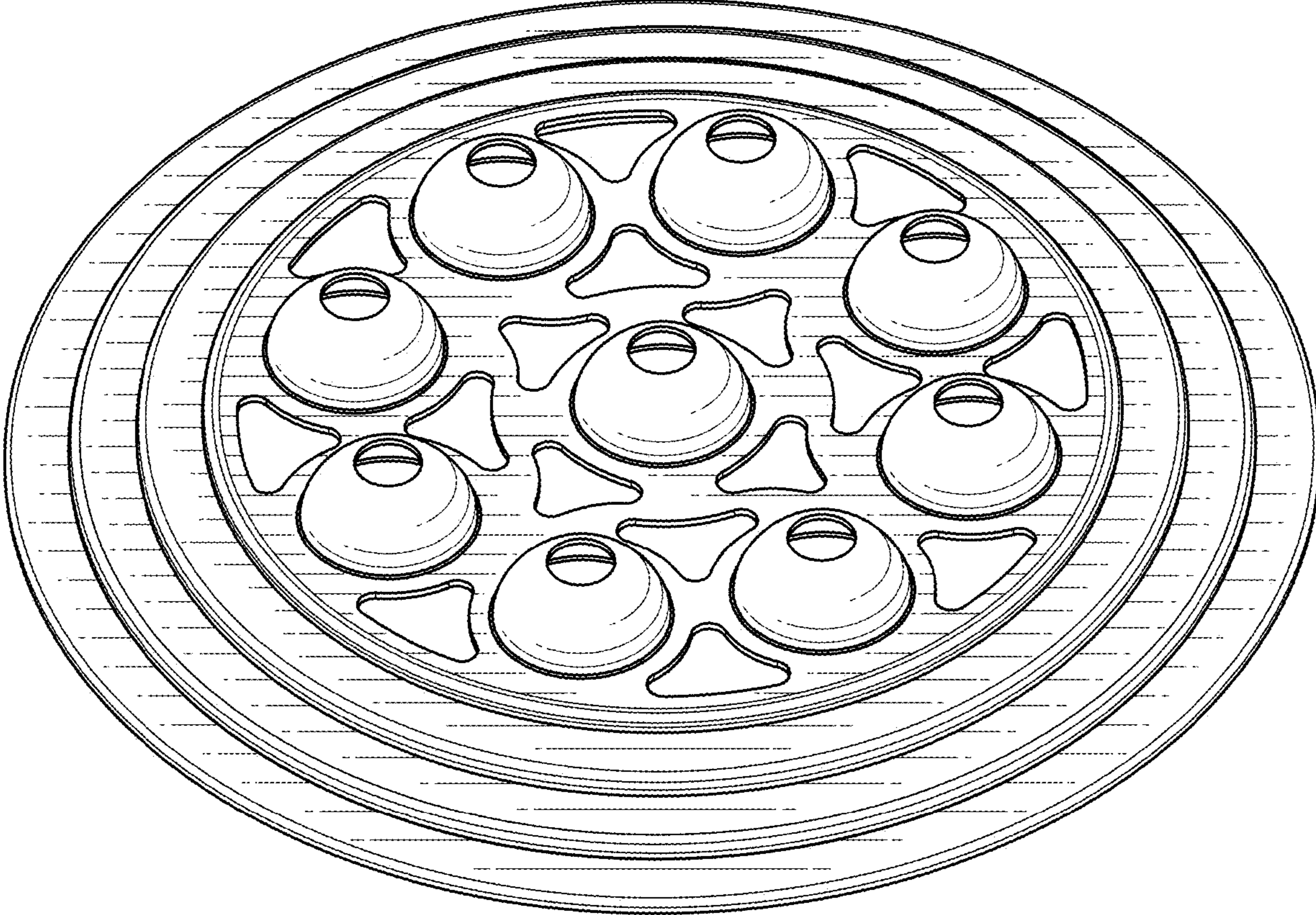

FIG. 2

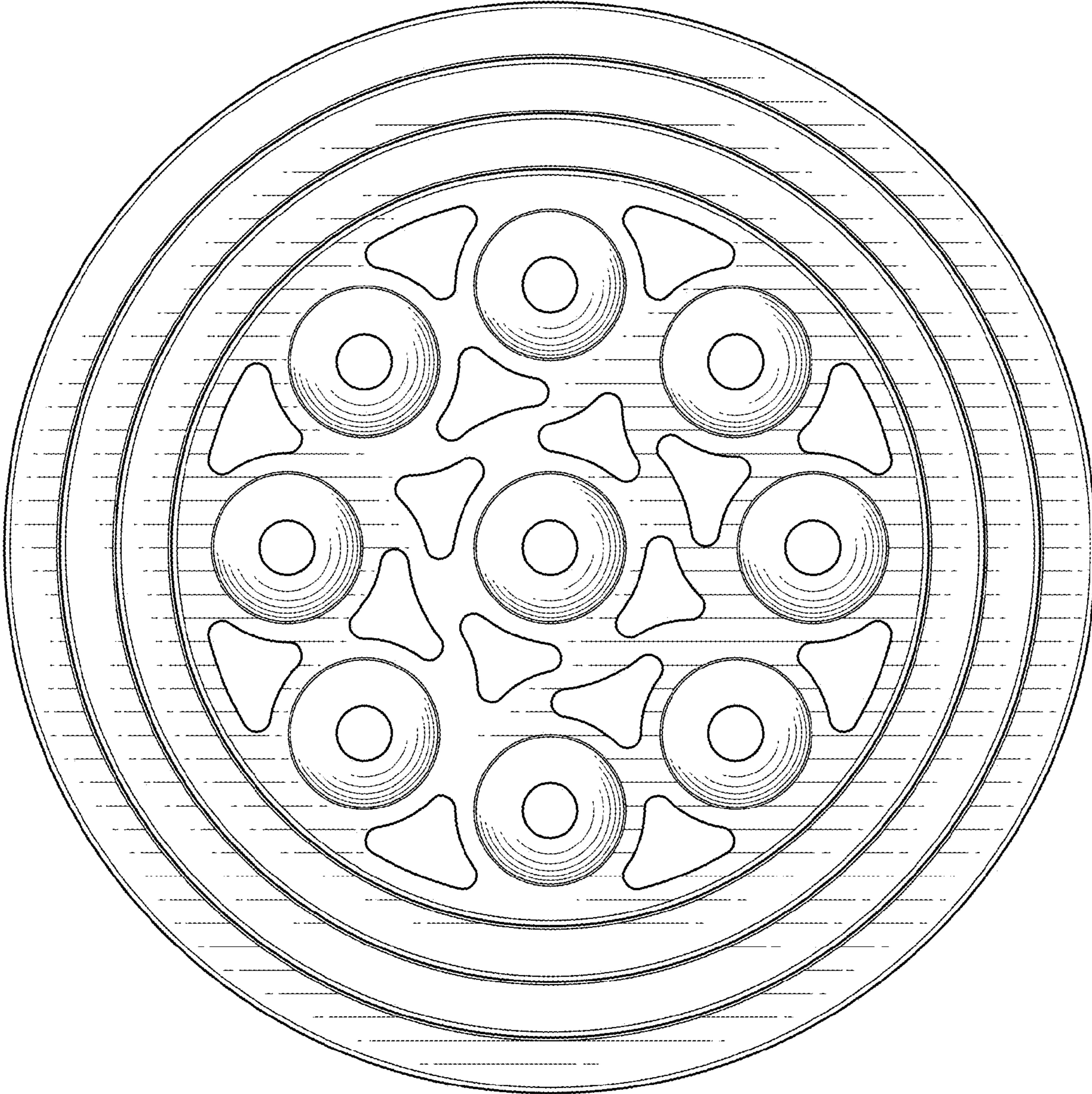

FIG. 3

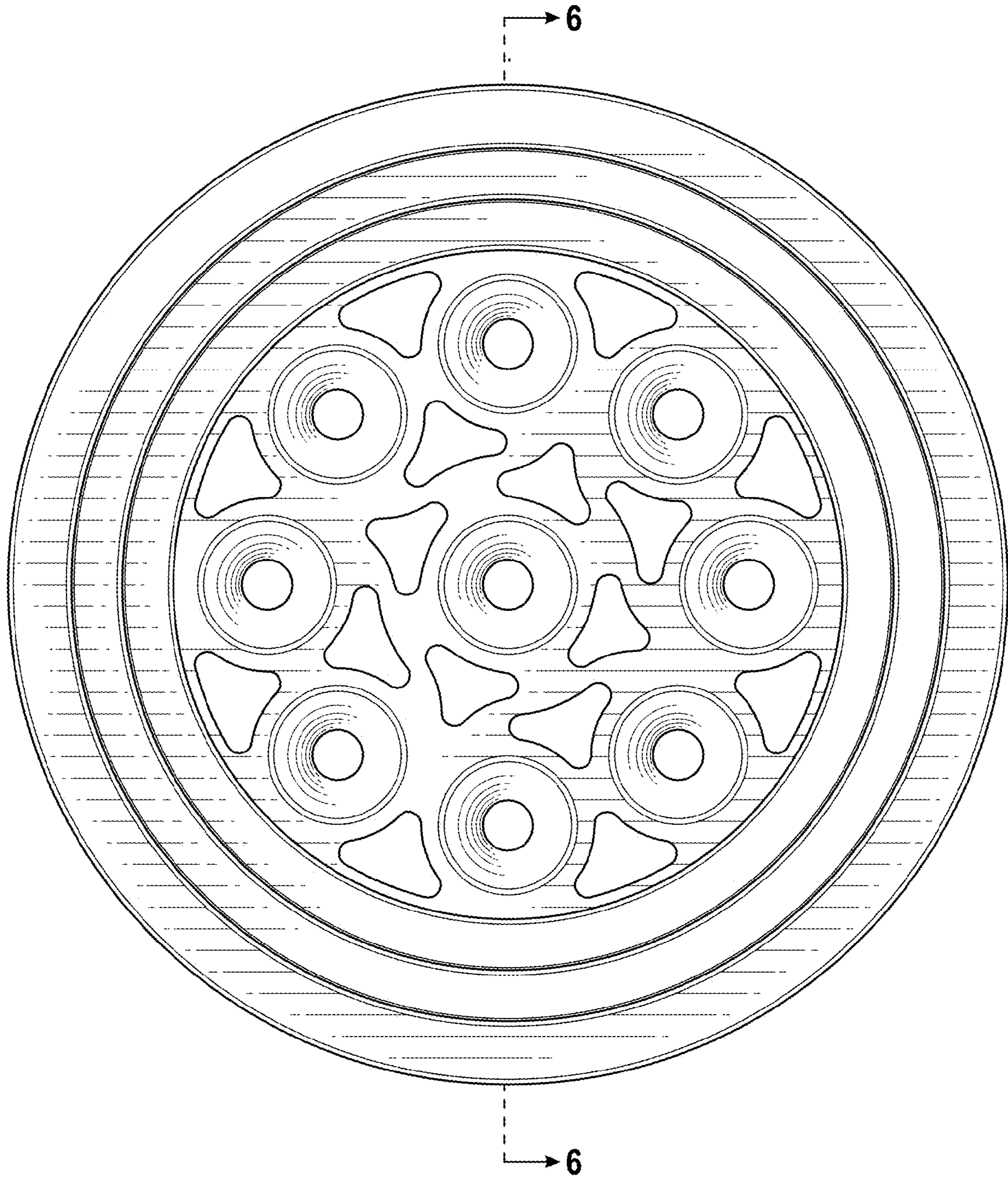

FIG. 4

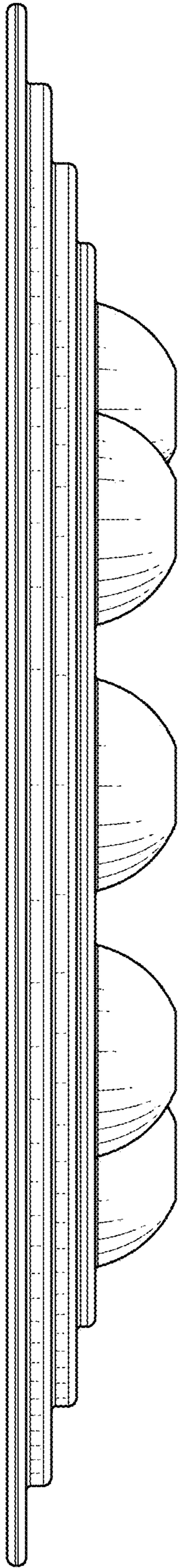

FIG. 5

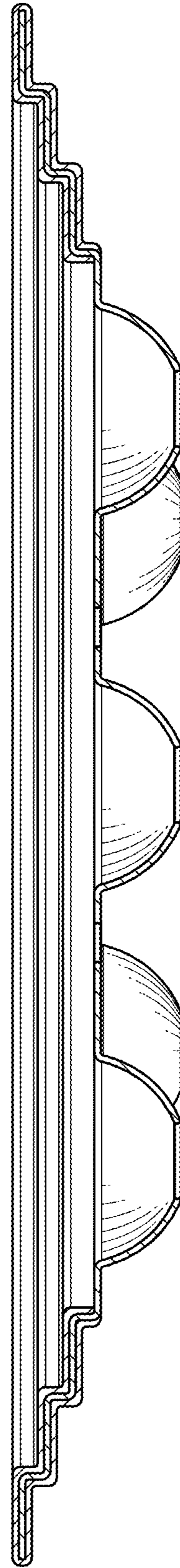

FIG. 6

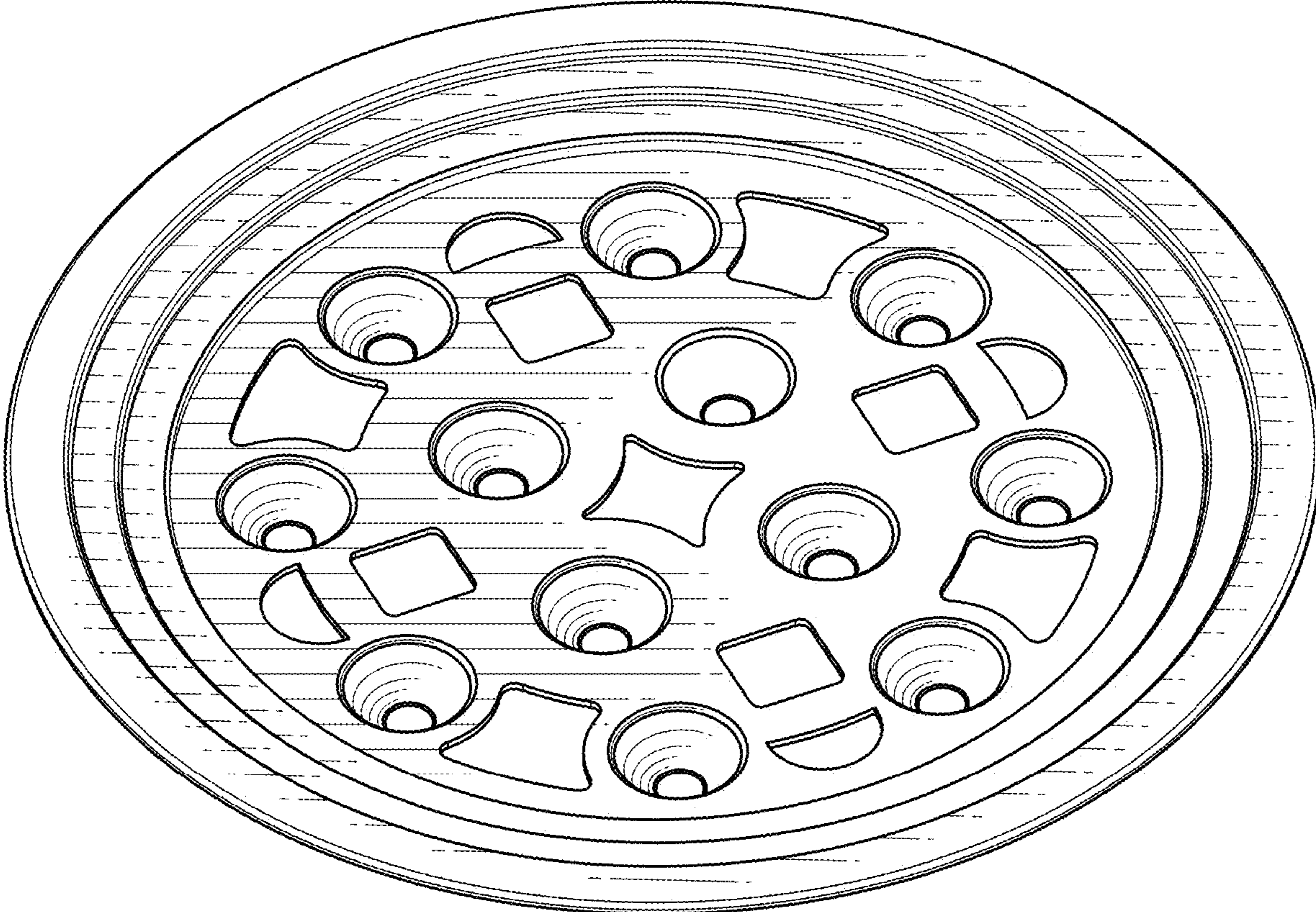

FIG. 7

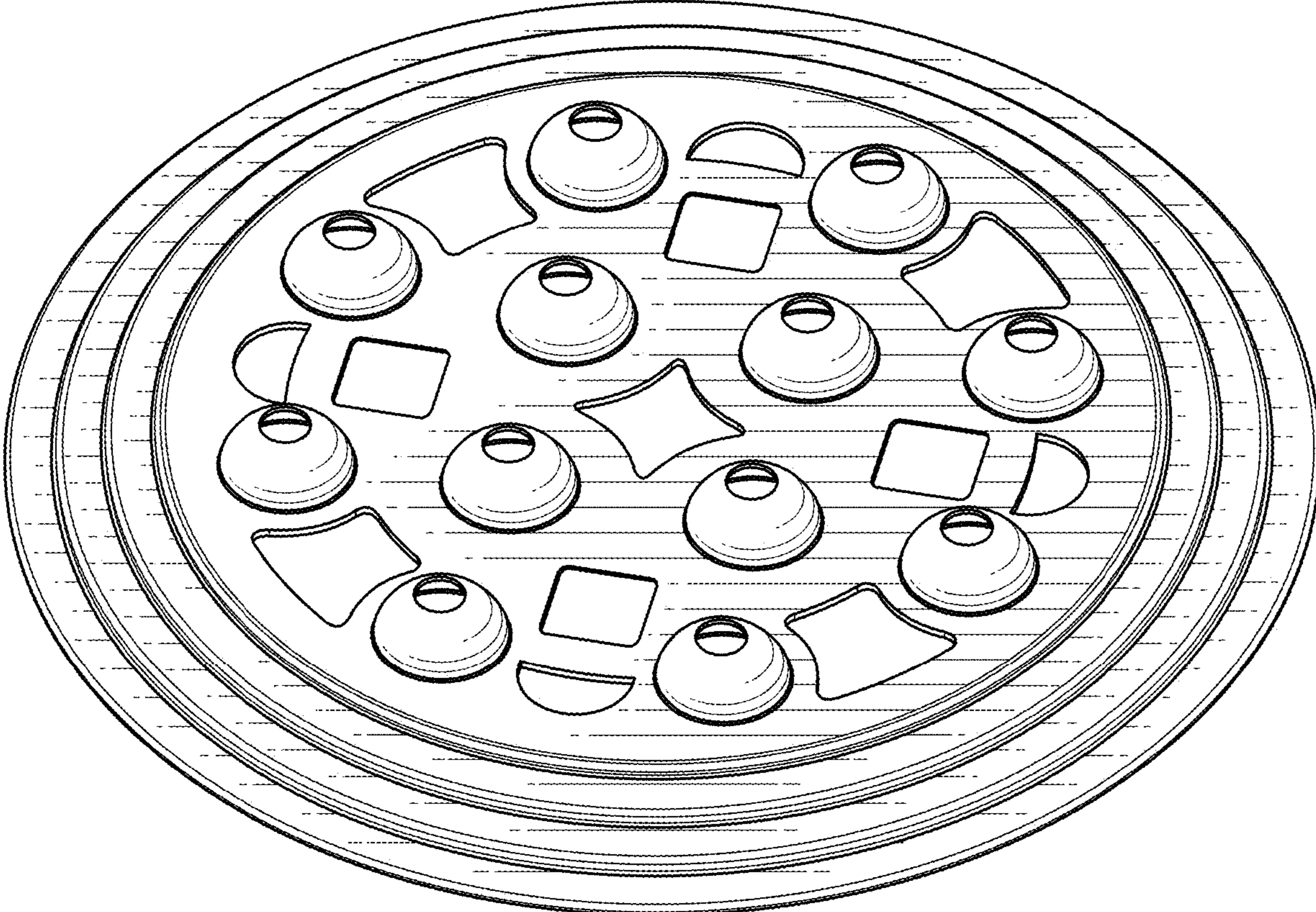

FIG. 8

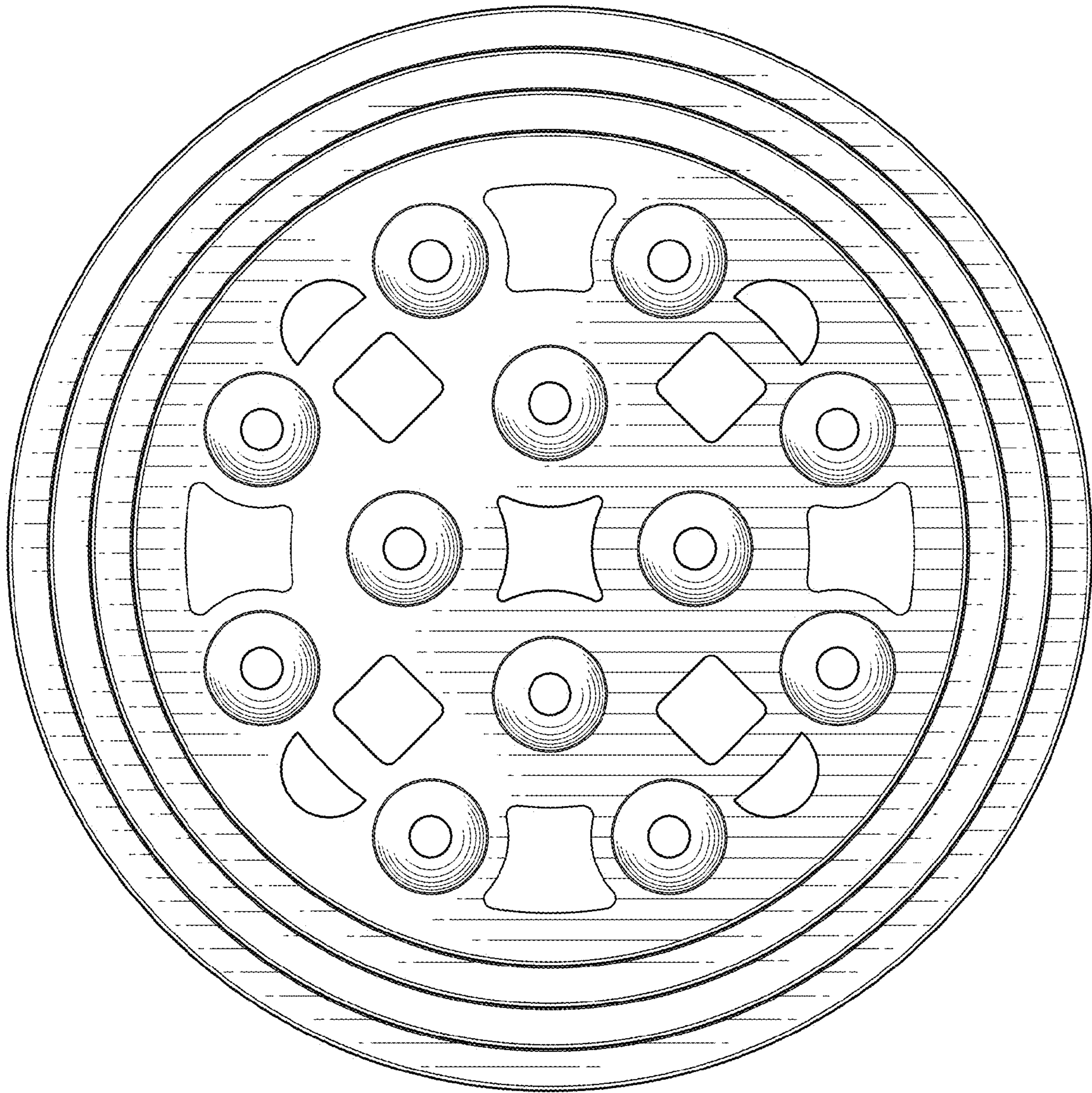

FIG. 9

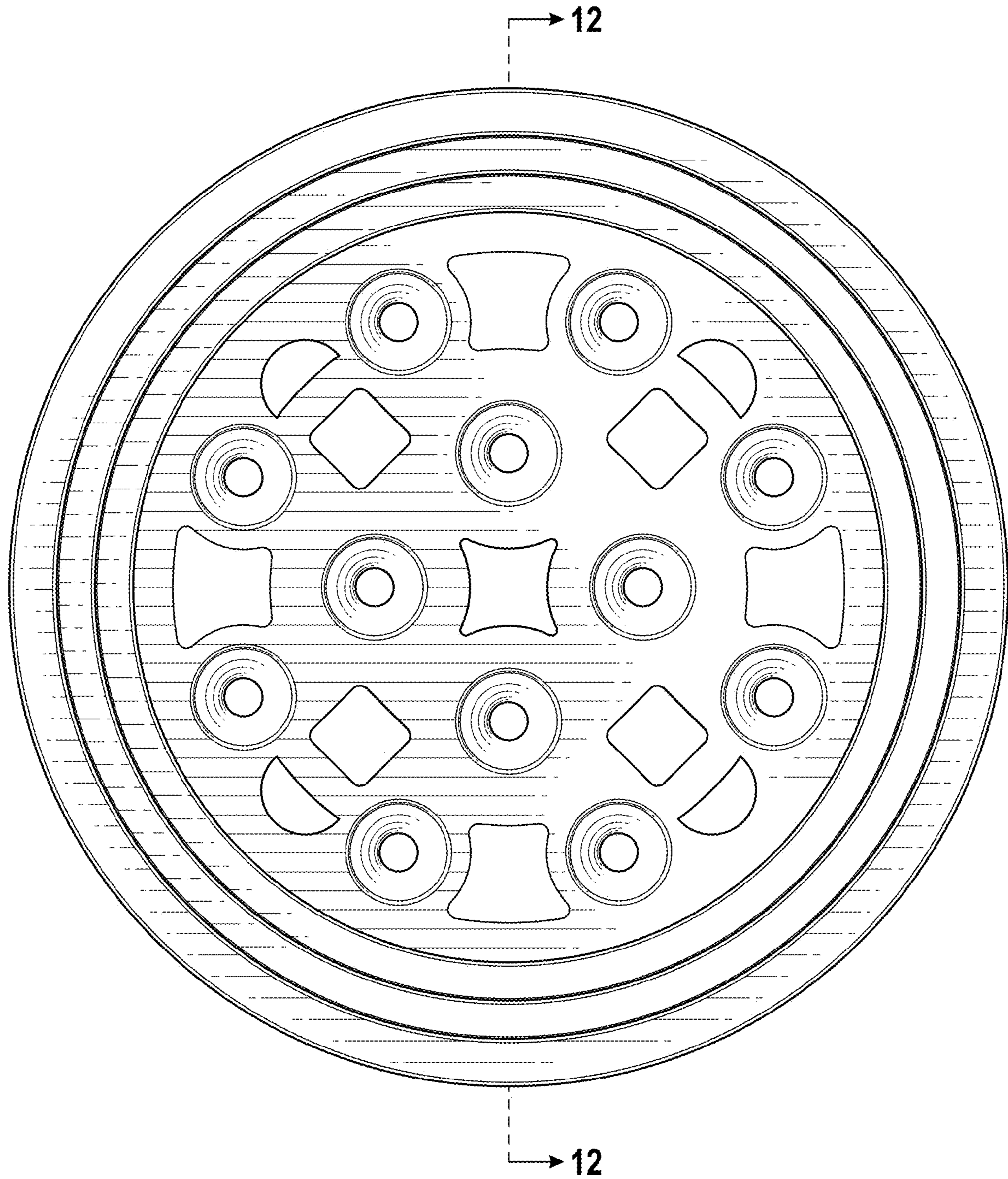

FIG. 10

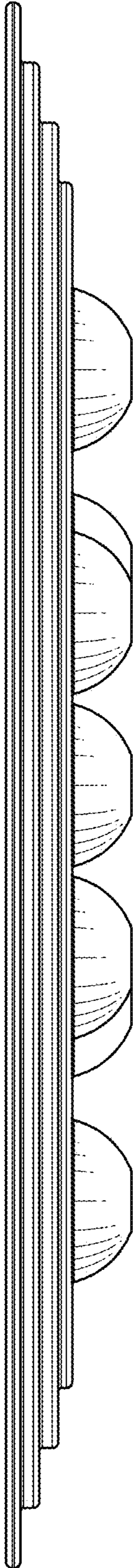

FIG. 11

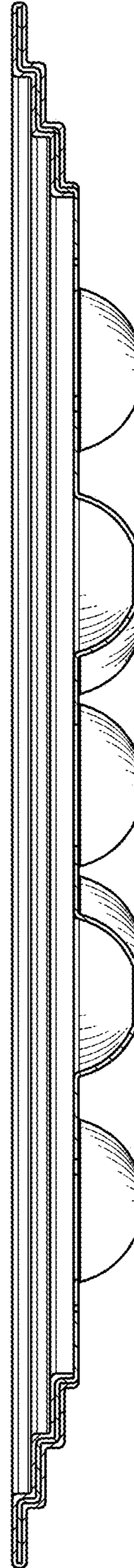

FIG. 12