



US00D898355S

(12) **United States Design Patent** (10) **Patent No.:** **US D898,355 S**
Cox (45) **Date of Patent:** **** Oct. 13, 2020**

(54) **COLLECTOR CARD AUTOGRAPH CASE**

2004/0007870 A1 1/2004 Ueno

(71) Applicant: **Clinton Gene Cox**, Centennial, CO (US)

* cited by examiner

(72) Inventor: **Clinton Gene Cox**, Centennial, CO (US)

Primary Examiner — Holly H Baynham

(74) *Attorney, Agent, or Firm* — Alistar Chan

(**) Term: **15 Years**

(57) **CLAIM**

The ornamental design collector card autograph case, as shown and described.

(21) Appl. No.: **29/699,316**

DESCRIPTION

(22) Filed: **Jul. 24, 2019**

FIG. 1 is a perspective view of a collector card autograph case in accordance with an exemplary embodiment.

(51) **LOC (12) Cl.** **03-01**

FIG. 2 is a front plan view of the collector card autograph case in accordance with the exemplary embodiment depicted in FIG. 1.

(52) **U.S. Cl.**

USPC **D3/247**

FIG. 3 is a rear plan view of the collector card autograph case in accordance with the exemplary embodiment depicted in FIG. 1.

(58) **Field of Classification Search**

USPC D3/247, 249–253, 300, 303

CPC B65D 43/16; B65D 85/48; A45C 1/06

See application file for complete search history.

FIG. 4 is a left side view of the collector card autograph case in accordance with the exemplary embodiment depicted in FIG. 1.

(56) **References Cited**

U.S. PATENT DOCUMENTS

4,322,001	A	3/1982	Hurley	
D435,339	S	* 12/2000	Cleveland A45C 1/06
				D3/247
D477,135	S	* 7/2003	Fu D3/247
D602,690	S	* 10/2009	Schochet D3/249
D744,236	S	* 12/2015	Turksu D3/303
D805,770	S	* 12/2017	Justiss D3/249
D835,408	S	* 12/2018	Justiss D3/247
D842,604	S	* 3/2019	Bo D3/247

FIG. 5 is a right side view of the collector card autograph case in accordance with the exemplary embodiment depicted in FIG. 1.

FIG. 6 is a top side view of the collector card autograph case in accordance with the exemplary embodiment depicted in FIG. 1; and,

FIG. 7 is a bottom side view of the collector card autograph case in accordance with the exemplary embodiment depicted in FIG. 1.

1 Claim, 5 Drawing Sheets

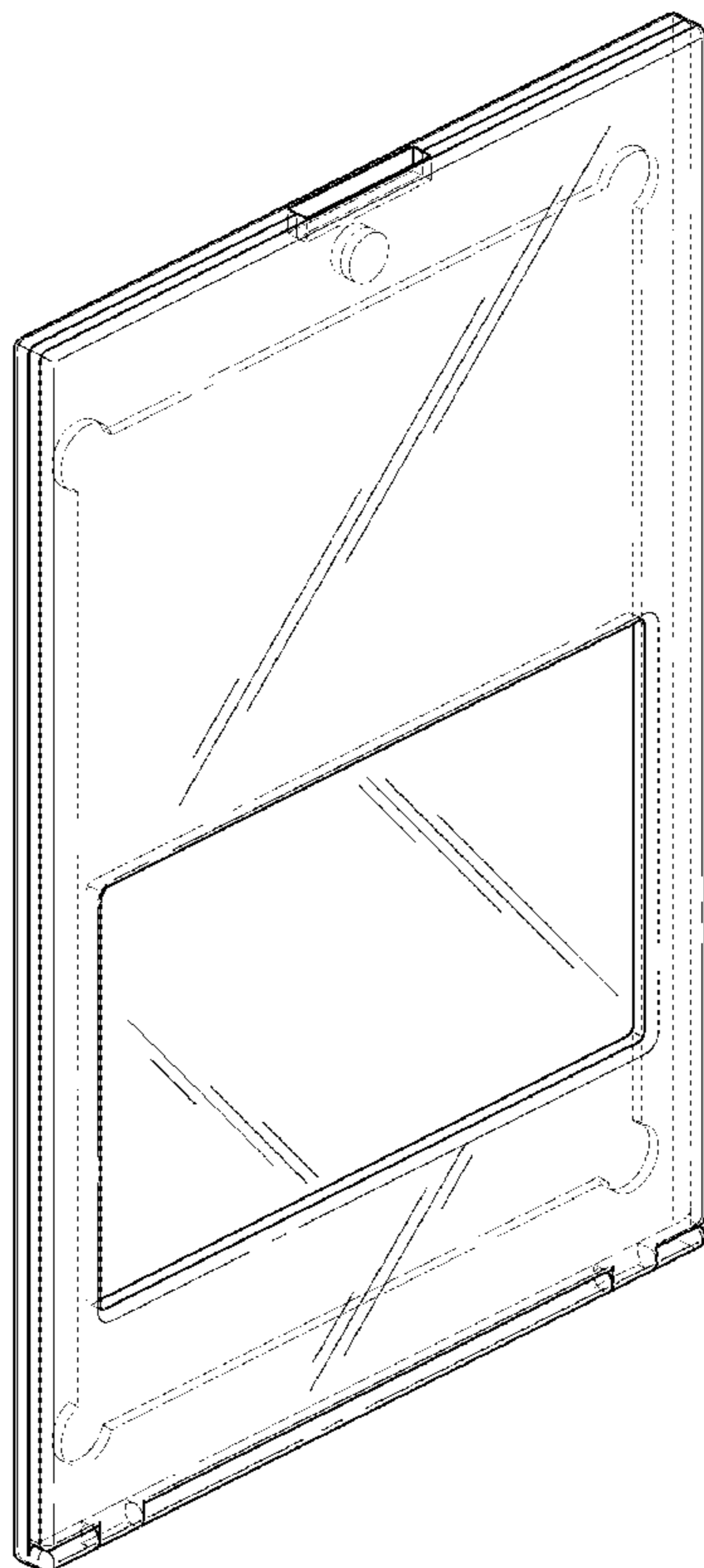

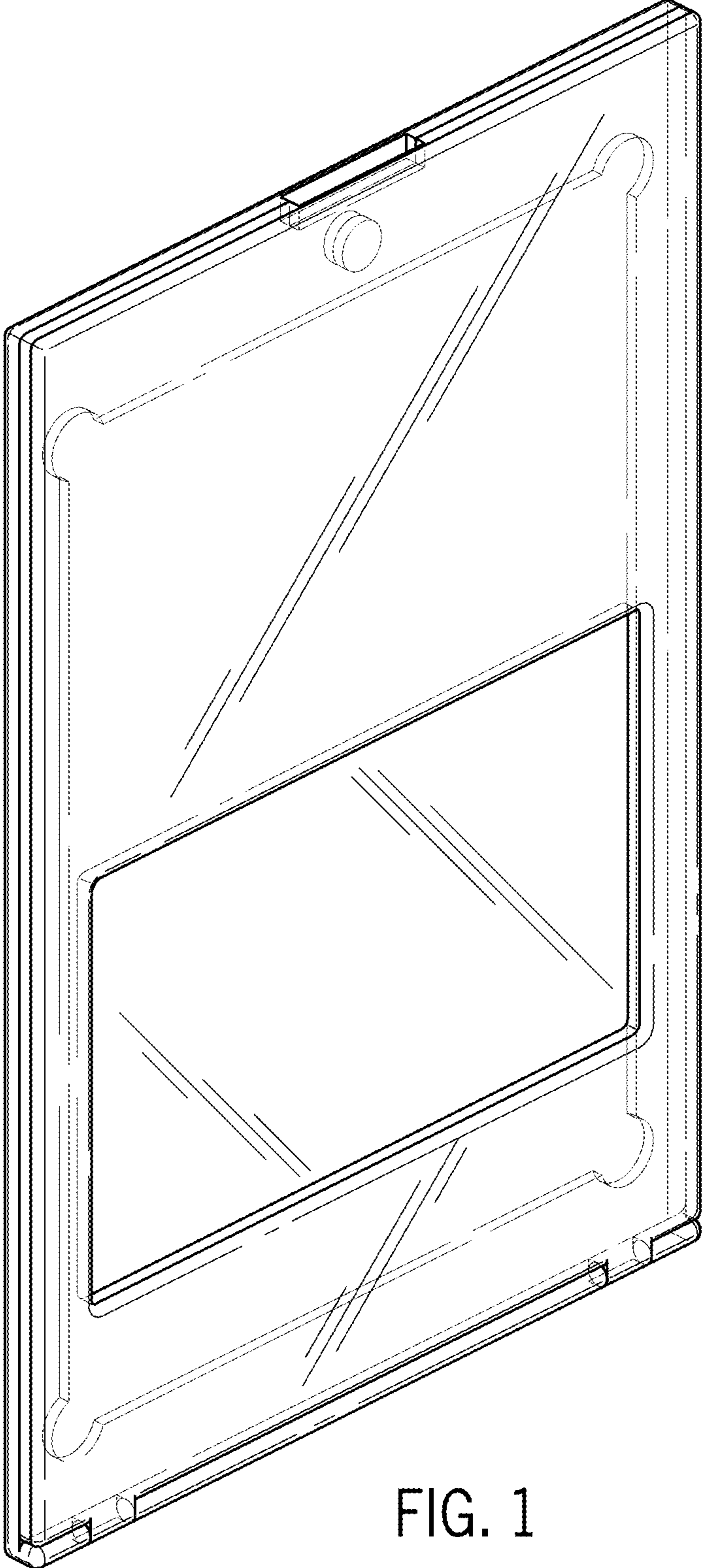

FIG. 1

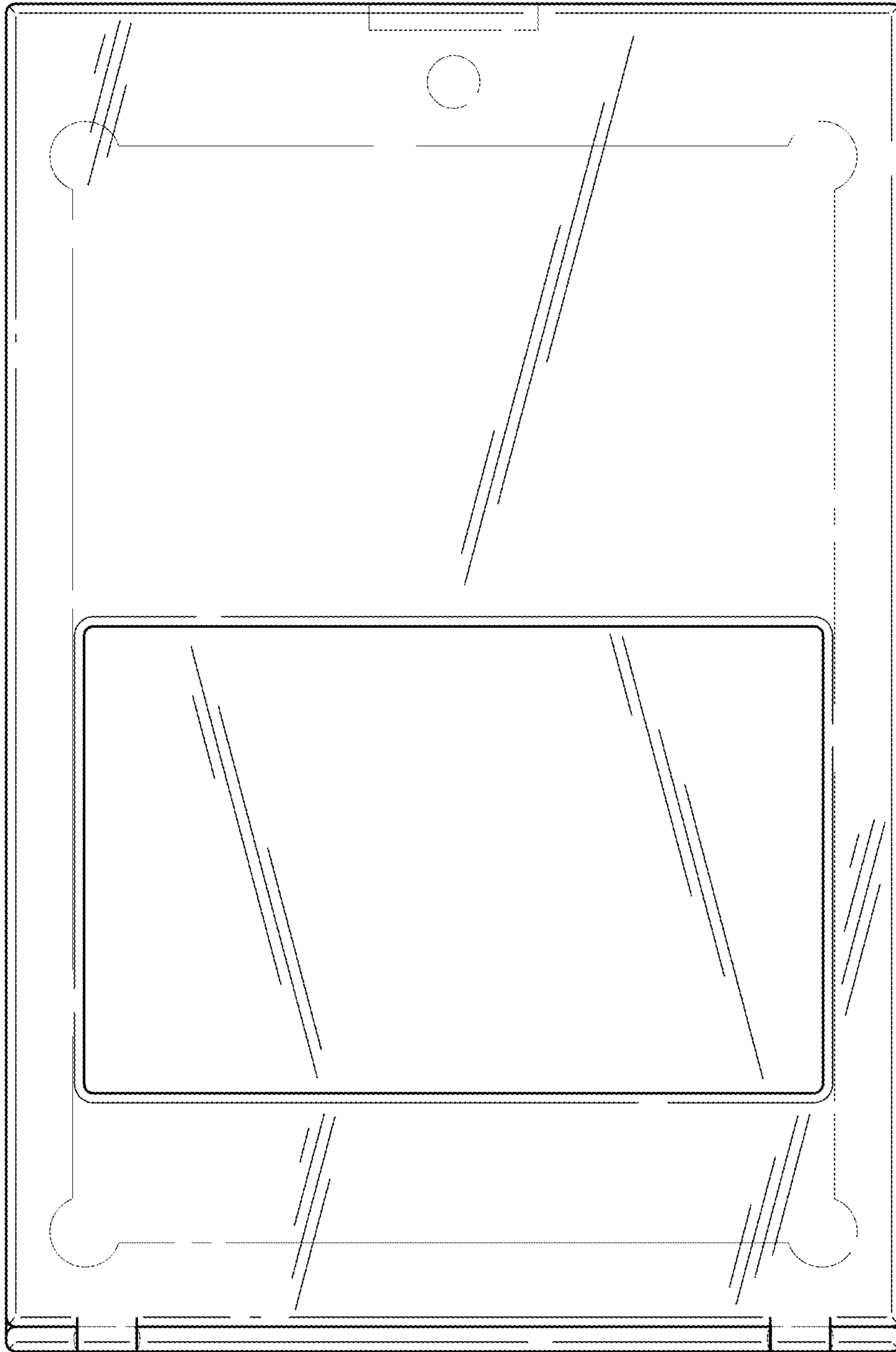

FIG. 2

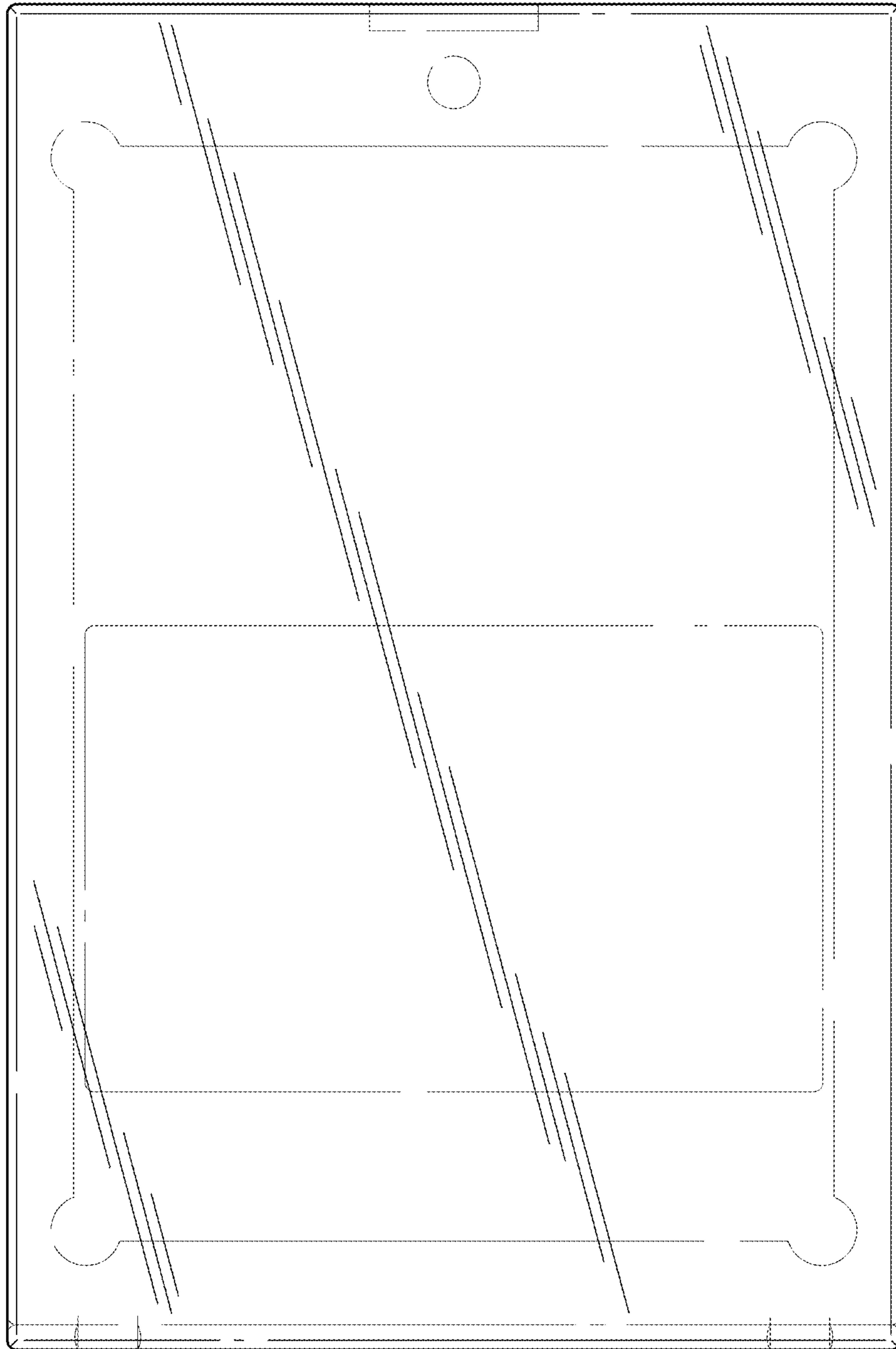

FIG. 3

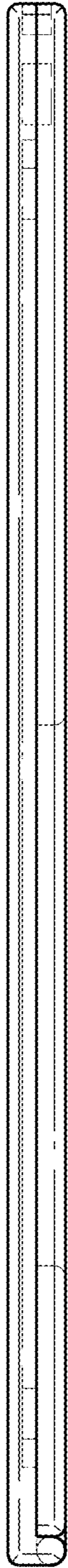

FIG. 4

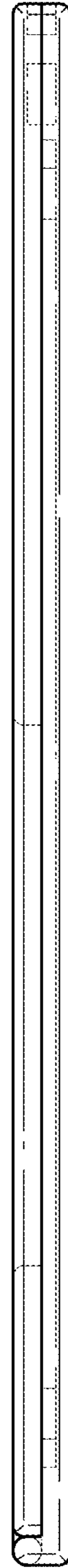

FIG. 5

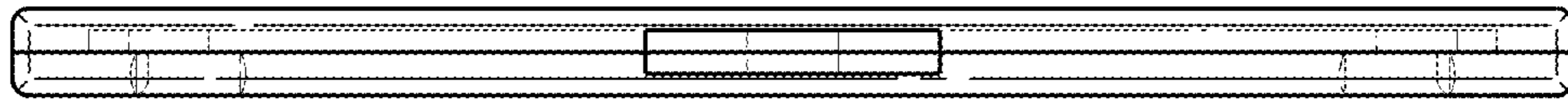

FIG. 6

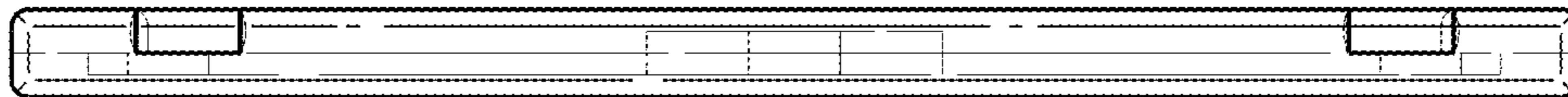

FIG. 7