



US00D898213S

(12) **United States Design Patent** (10) **Patent No.:** **US D898,213 S**  
**Sedic** (45) **Date of Patent:** **\*\* Oct. 6, 2020**

- (54) **SKIN MASSAGER**
- (71) Applicant: **Filip Sedic**, Stockholm (SE)
- (72) Inventor: **Filip Sedic**, Stockholm (SE)
- (\*\*) Term: **15 Years**
- (21) Appl. No.: **29/728,218**
- (22) Filed: **Mar. 17, 2020**

**Related U.S. Application Data**

- (62) Division of application No. 29/678,094, filed on Jan. 25, 2019, now Pat. No. Des. 882,104.
- (51) **LOC (12) Cl.** ..... **28-03**
- (52) **U.S. Cl.**  
USPC ..... **D24/215**
- (58) **Field of Classification Search**  
USPC ..... D24/200, 211, 212, 213, 214, 215;  
D28/63; D30/160; D4/102  
(Continued)

(56) **References Cited**

**U.S. PATENT DOCUMENTS**

- 1,491,016 A 4/1924 McGowan et al.
  - 2,480,023 A 8/1949 Holden
- (Continued)

**FOREIGN PATENT DOCUMENTS**

- EP 1484043 12/2004
  - EP 1525872 4/2005
- (Continued)

**OTHER PUBLICATIONS**

“Silicone Face Massage Brush,” Alibaba.com, 1999-2014, Alibaba.com, 6 pages [Online] [Retrieved on Sep. 15, 2014] Retrieved from the Internet<URL:http://www.alibaba.com/countrysearch/CN/silicone-face-massage-brush.html.

(Continued)

*Primary Examiner* — Cynthia Ramirez  
*Assistant Examiner* — Michael A Maharajh  
(74) *Attorney, Agent, or Firm* — Evan Feldstein

(57) **CLAIM**

I claim the ornamental design for a skin massager, as shown and described.

**DESCRIPTION**

FIG. 1 is a perspective view of a first embodiment of a skin massager.  
 FIG. 2 is a front view of the first embodiment of the skin massager.  
 FIG. 3 is a rear view of the first embodiment of the skin massager.  
 FIG. 4 is a right side view of the first embodiment of the skin massager.  
 FIG. 5 is a left side view of the first embodiment of the skin massager.  
 FIG. 6 is a top view of the first embodiment of the skin massager.  
 FIG. 7 is a bottom view of the first embodiment of the skin massager.  
 FIG. 8 is a perspective view of a second embodiment of a skin massager.  
 FIG. 9 is a front view of the second embodiment of the skin massager.  
 FIG. 10 is a rear view of the second embodiment of the skin massager.  
 FIG. 11 is a right side view of the second embodiment of the skin massager.  
 FIG. 12 is a left side view of the second embodiment of the skin massager.  
 FIG. 13 is a top view of the second embodiment of the skin massager; and,  
 FIG. 14 is a bottom view of the second embodiment of the skin massager.  
 The broken lines shown in the figures are for the purposes of illustrating portions of the skin massager, which form no part of the claimed design.

**1 Claim, 14 Drawing Sheets**

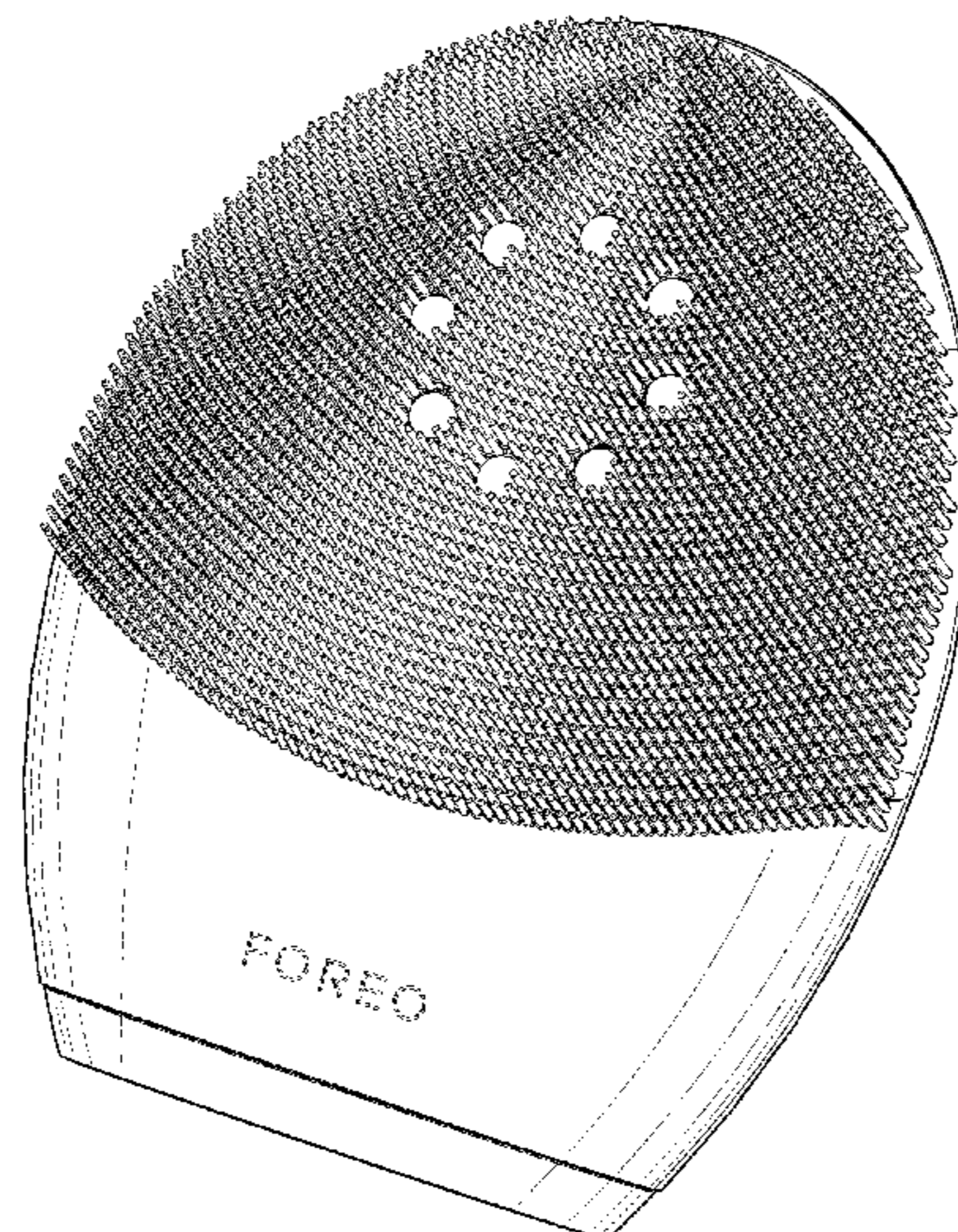



(56)

**References Cited**

OTHER PUBLICATIONS

“Clarisonic” Web Page, Clarisonic, Pacific Bioscience Laboratories, Inc., 2013, 2 pages, [Online] [Retrieved on Sep. 15, 2014] Retrieved from the Internet<URL: <http://www.clarisonic.com/>>.

“Neutrogena® Wave®,” Neutrogena Corporation, 2014, 1 page, [Online] [Retrieved on Sep. 15, 2014] Retrieved from the Internet<URL: <http://www.neutrogenawave.com/#/products>>.

“Silicon Face Brushes,” Alibaba.com, 1999-2014, Alibaba.com, 8 pages [Online] [Retrieved on Sep. 15, 2014] Retrieved from the Internet<URL: <http://www.alibaba.com/manufacturers/face-silicone-brush-manufacturer.html>>.

“Vibrating cosmetics,” 12 pages, PoshGlam®, Sep. 8, 2014, [Online] [Retrieved on Sep. 15, 2014] Retrieved from the Internet<URL: <http://www.poshglam.com/beauty/>>.

“Waterproof Electric Face Massager,” Alibaba.com, 1999-2014, 3 pages, [Online] [Retrieved on Sep. 15, 2014] Retrieved from the Internet<URL: [http://www.alibaba.com/product-gs/537532136/Water\\_proof\\_Electric\\_Face\\_Massager.html](http://www.alibaba.com/product-gs/537532136/Water_proof_Electric_Face_Massager.html)>.

“Skincare,” www.foreo.com, FOREO, accessed Jan. 20, 2019, pp. 1-13.

\* cited by examiner

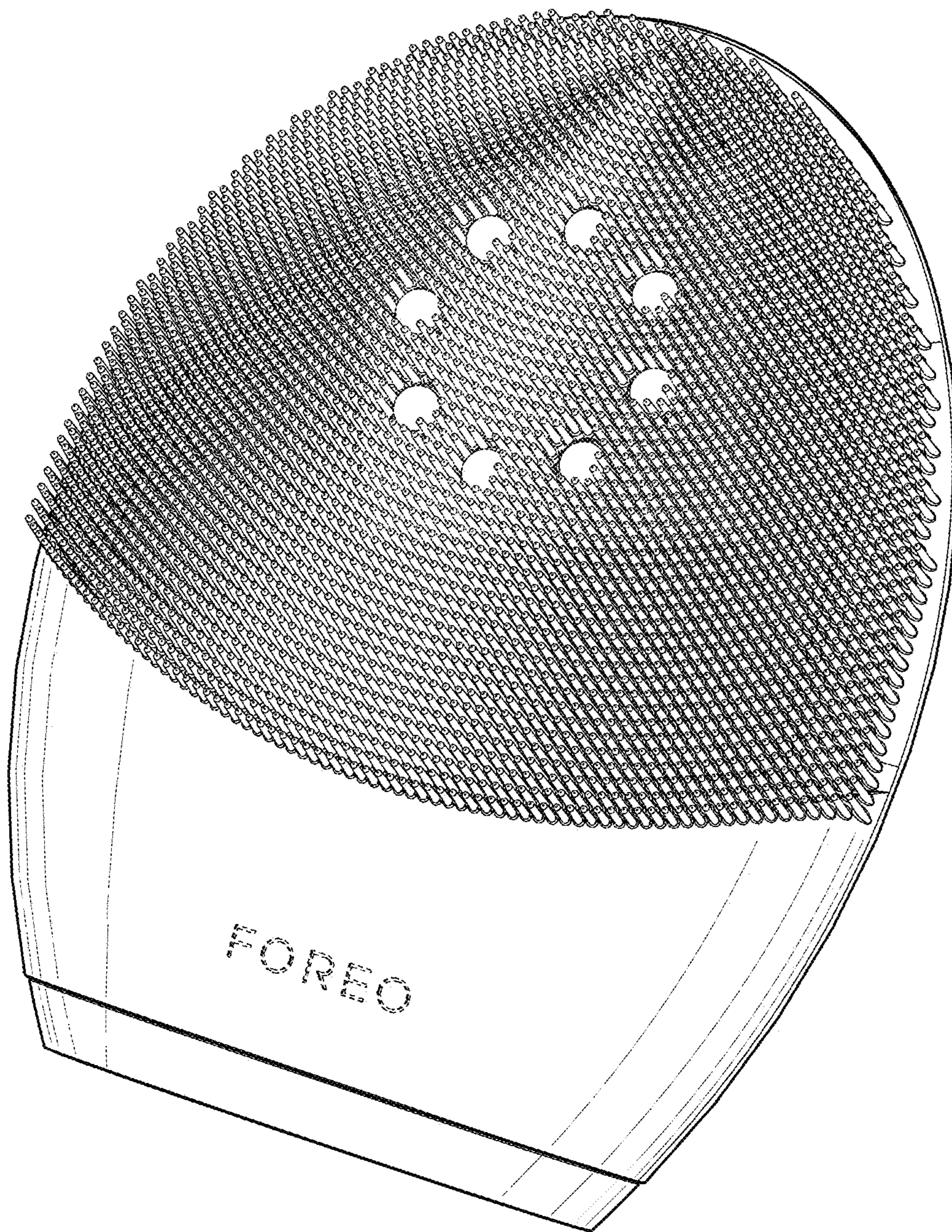

FIG. 1

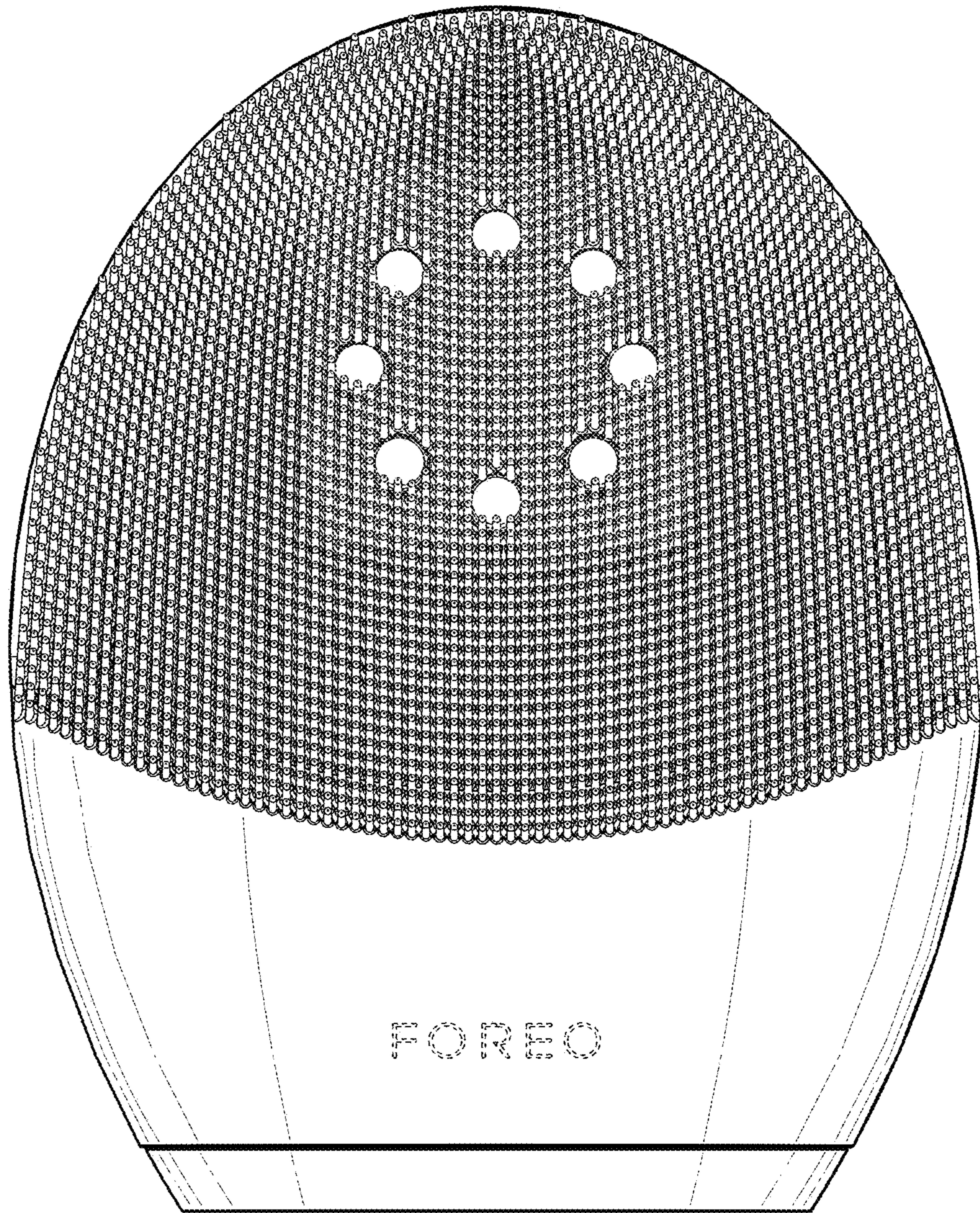

FIG. 2

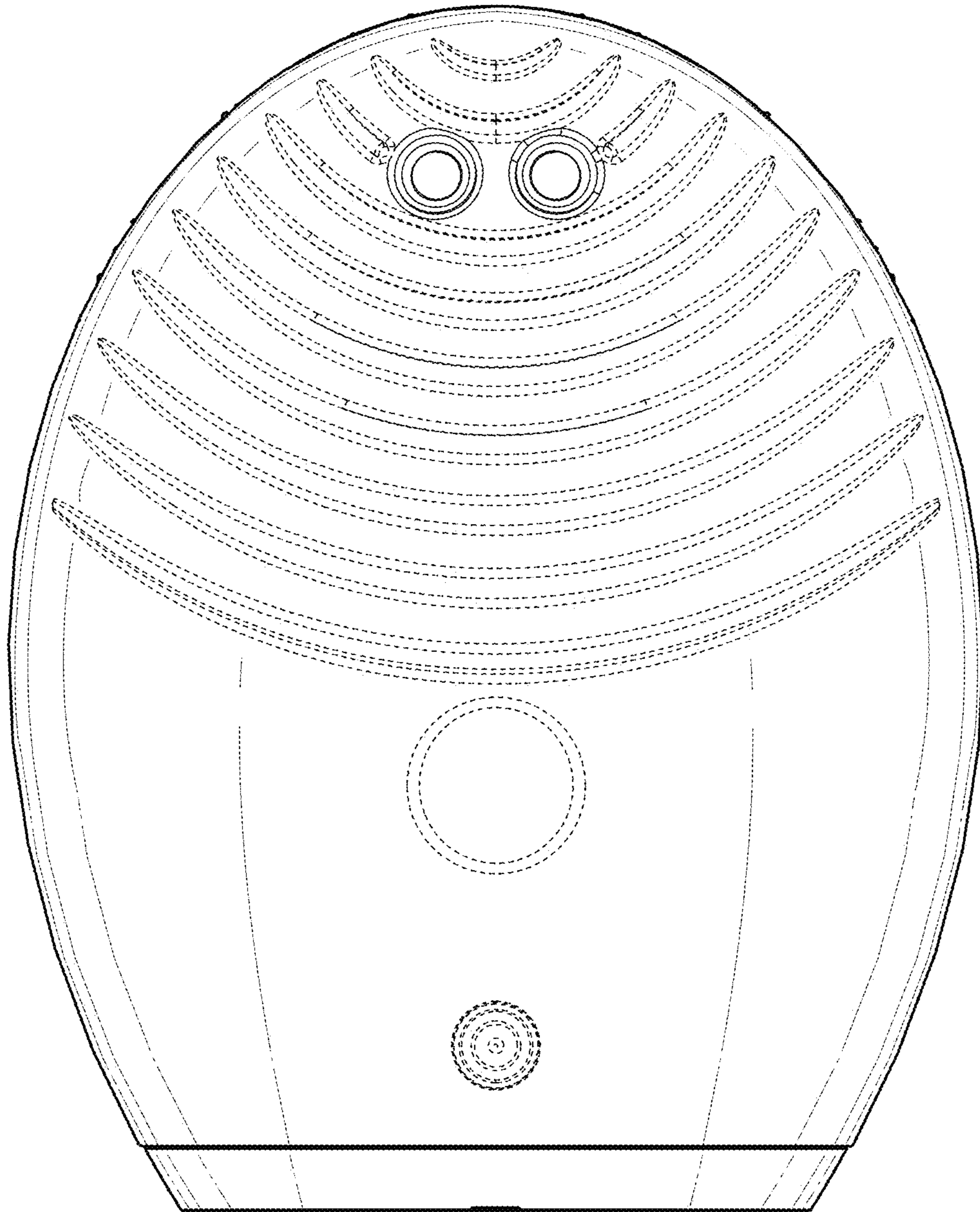

FIG. 3

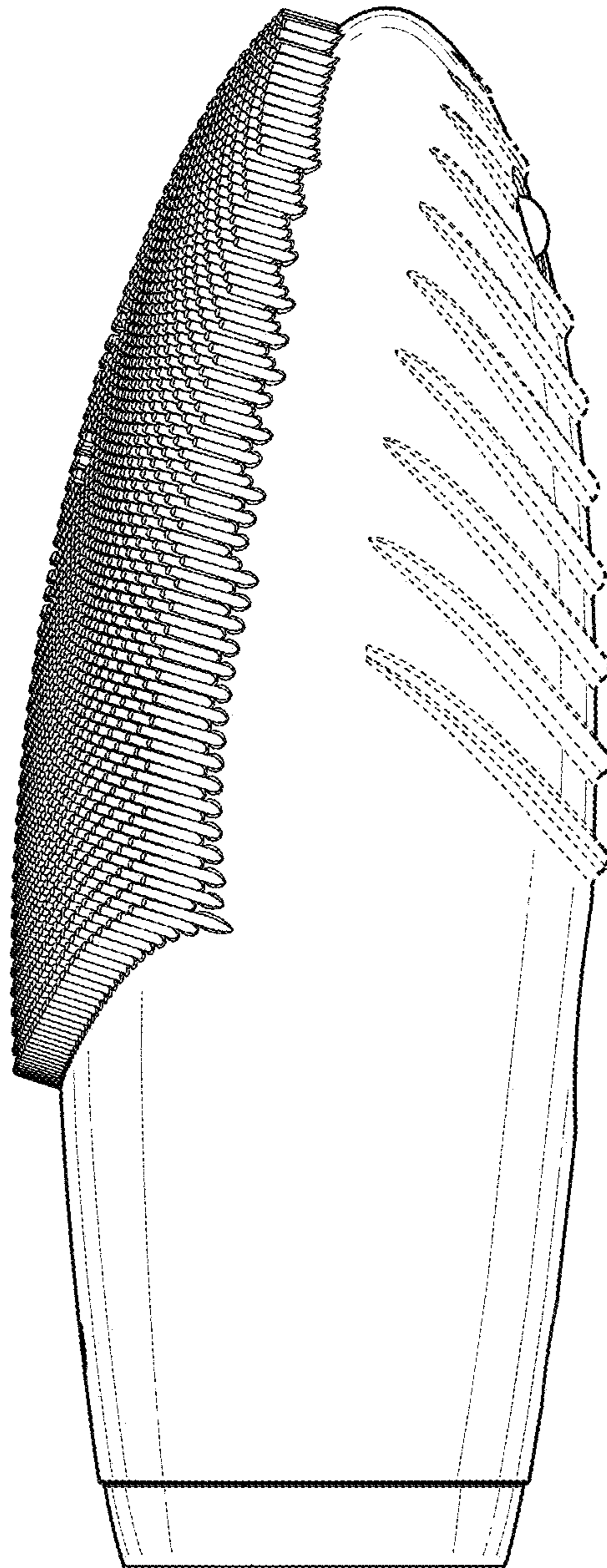

FIG. 4

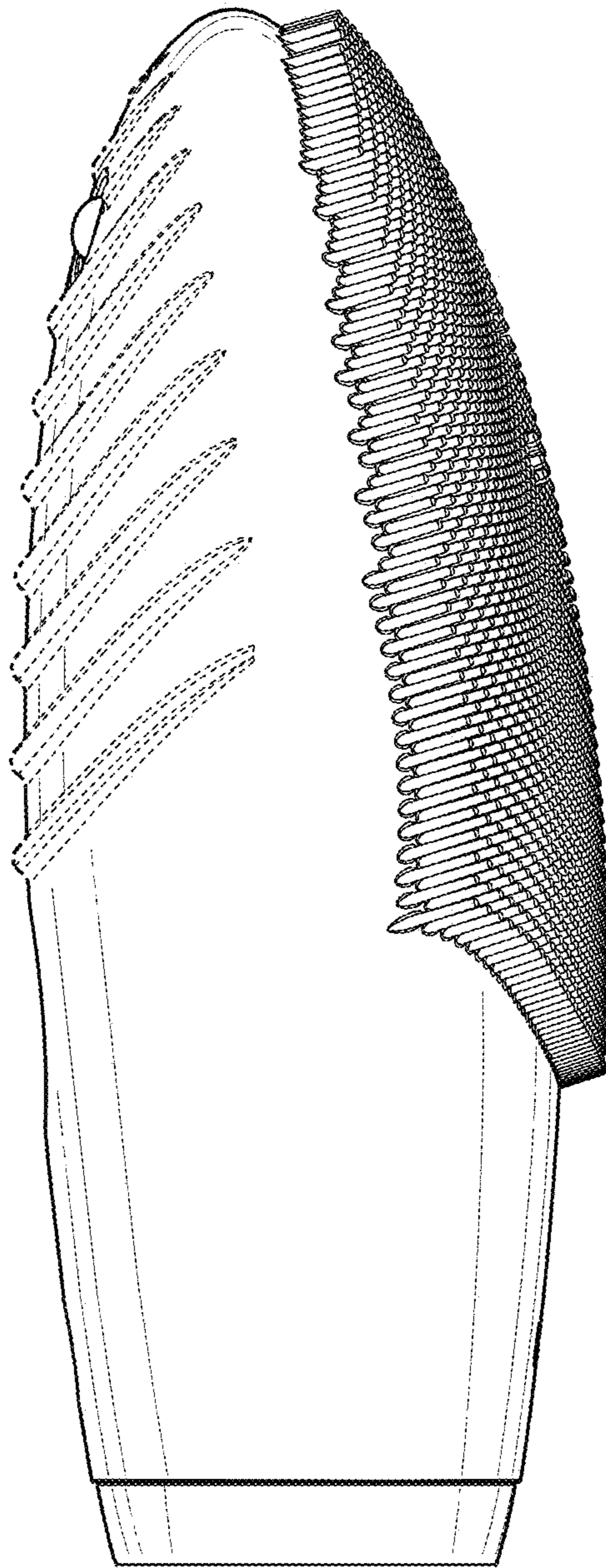

FIG. 5



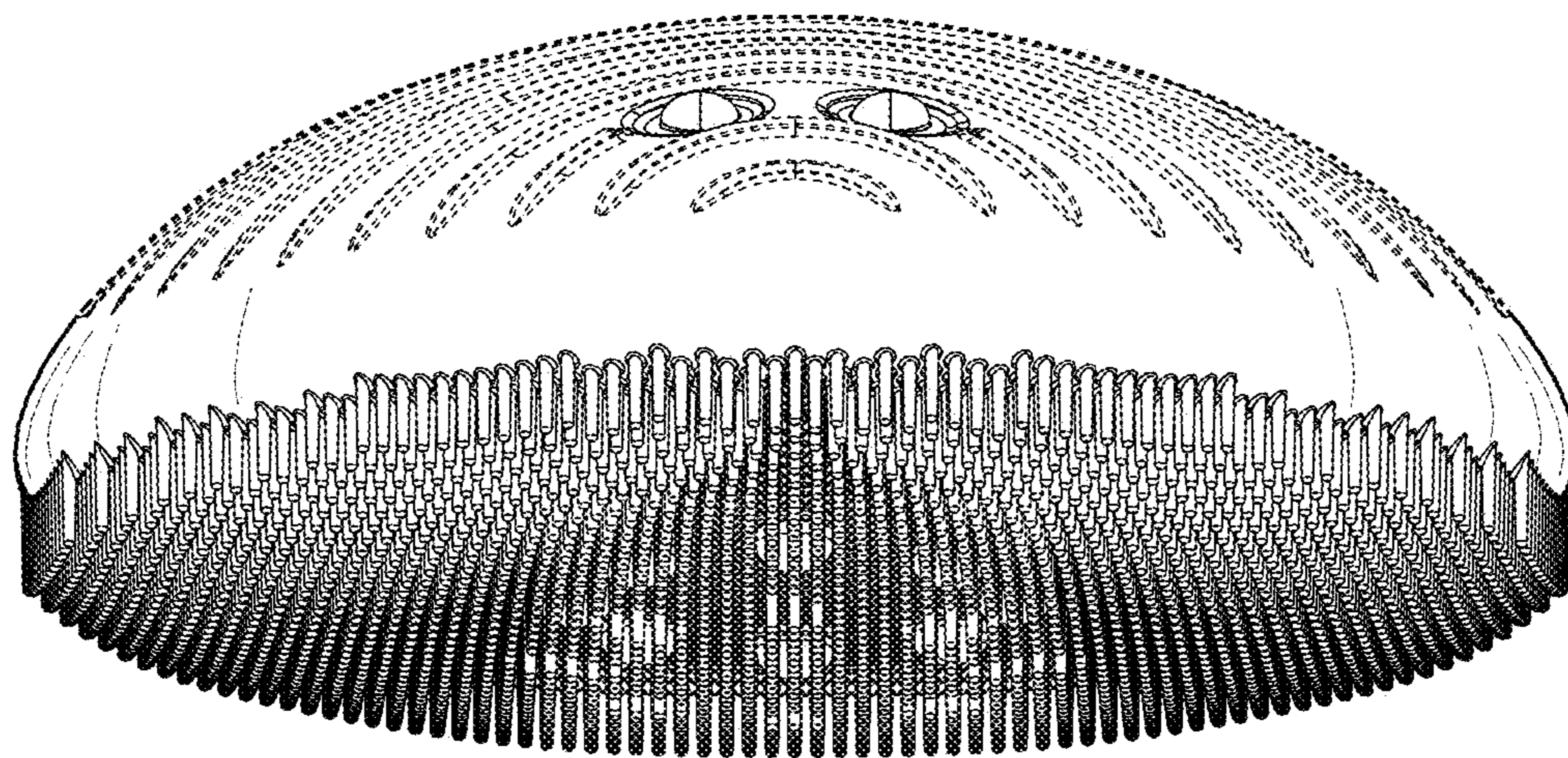

FIG. 6

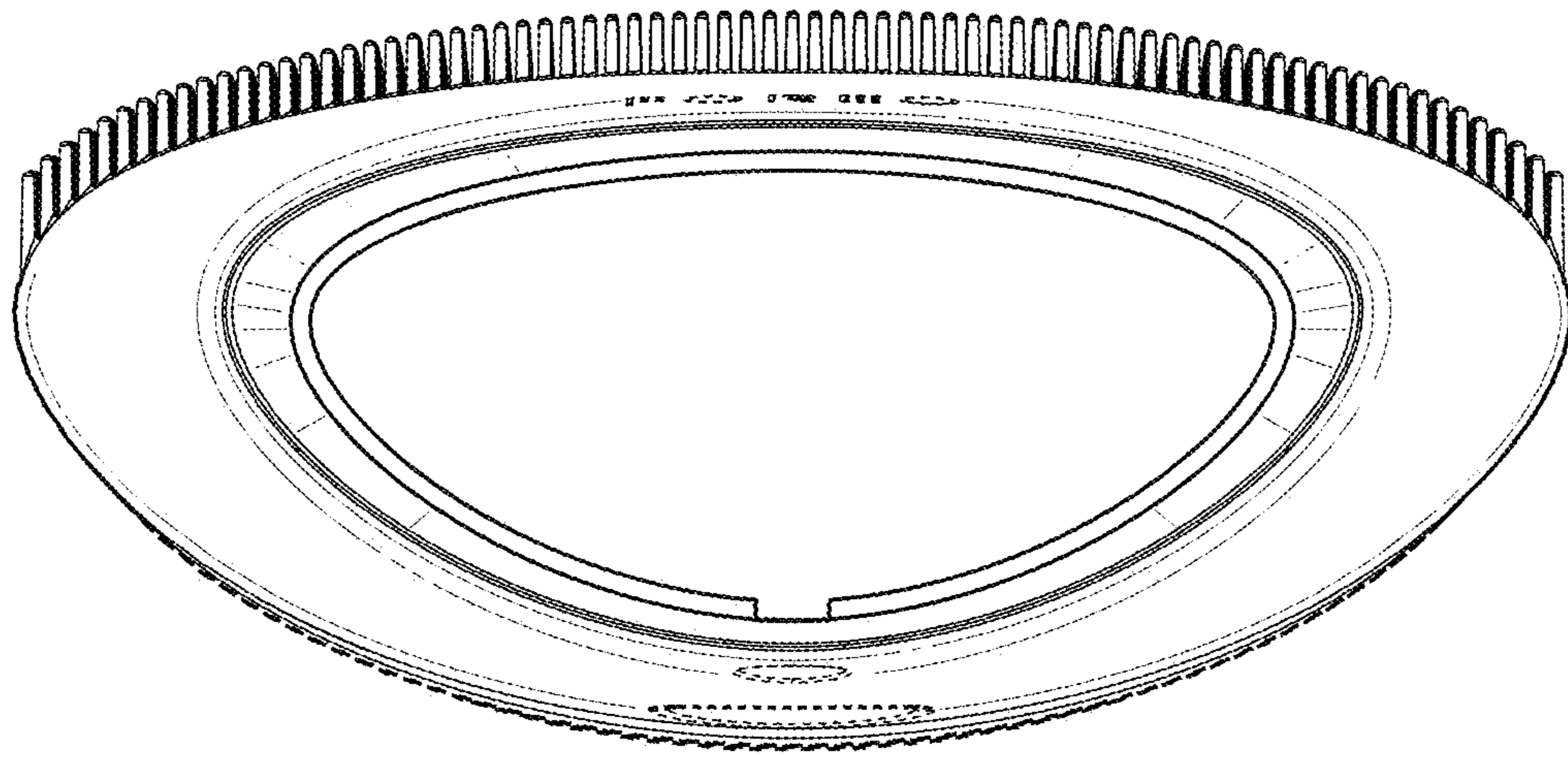

FIG. 7

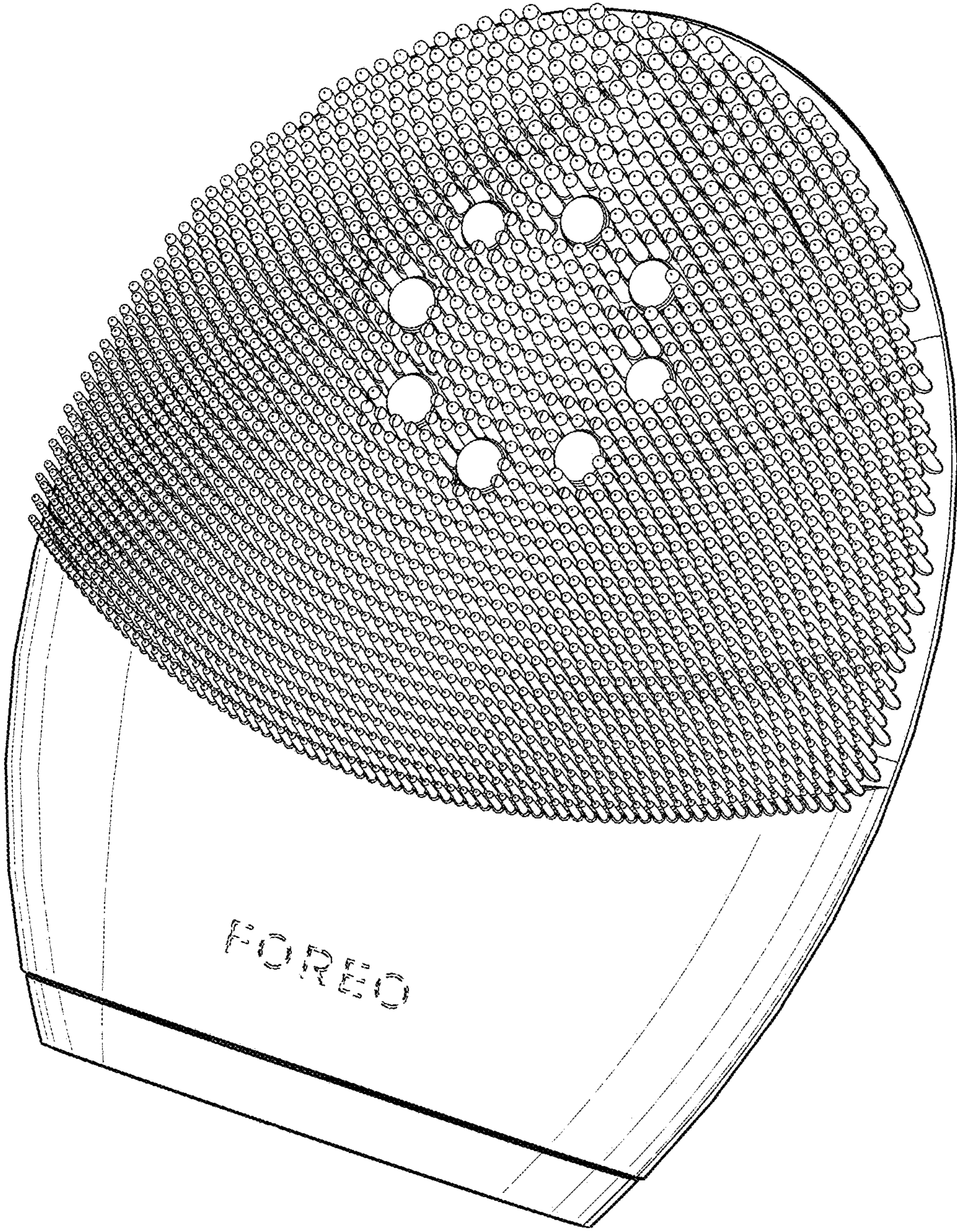

FIG. 8

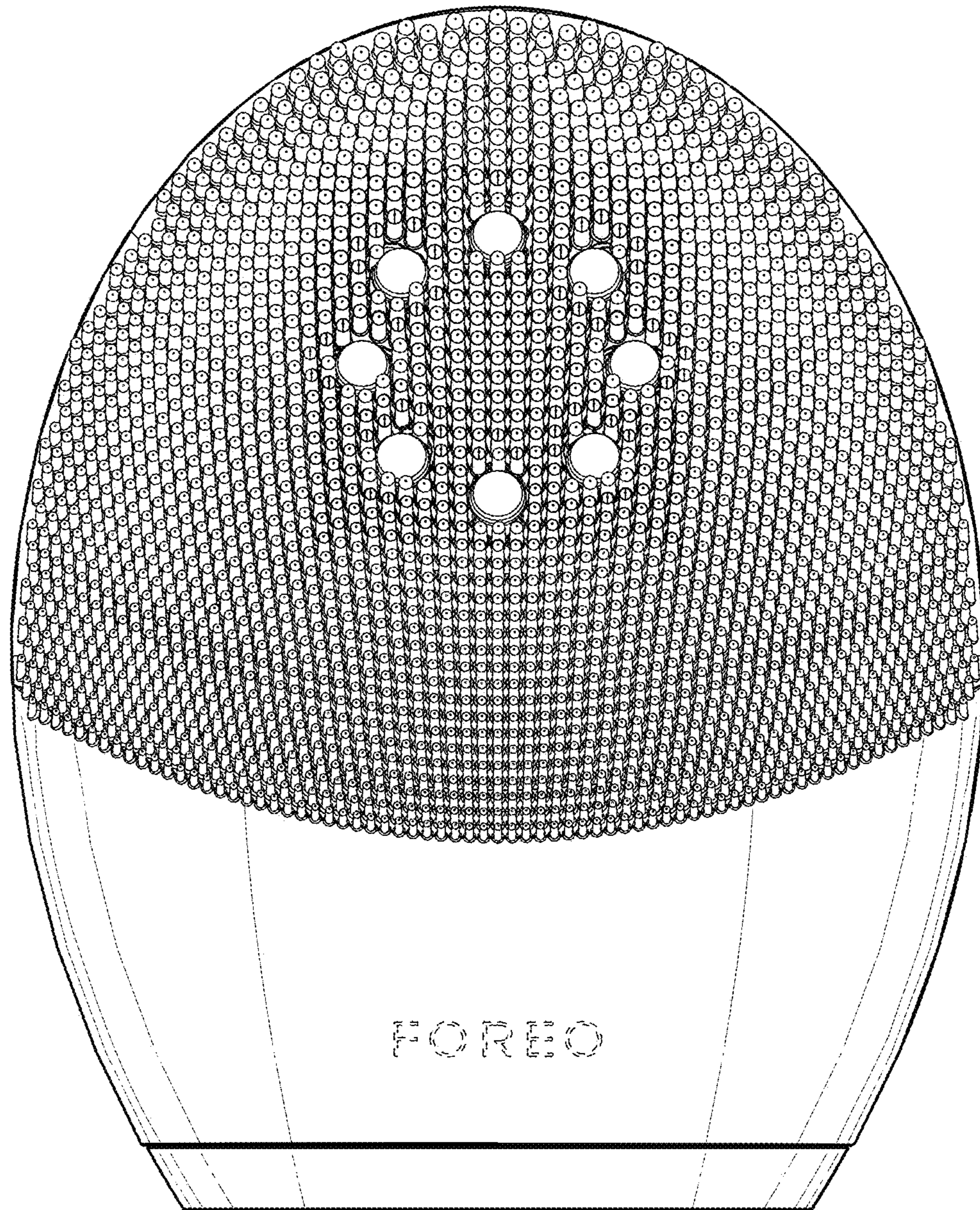

FIG. 9

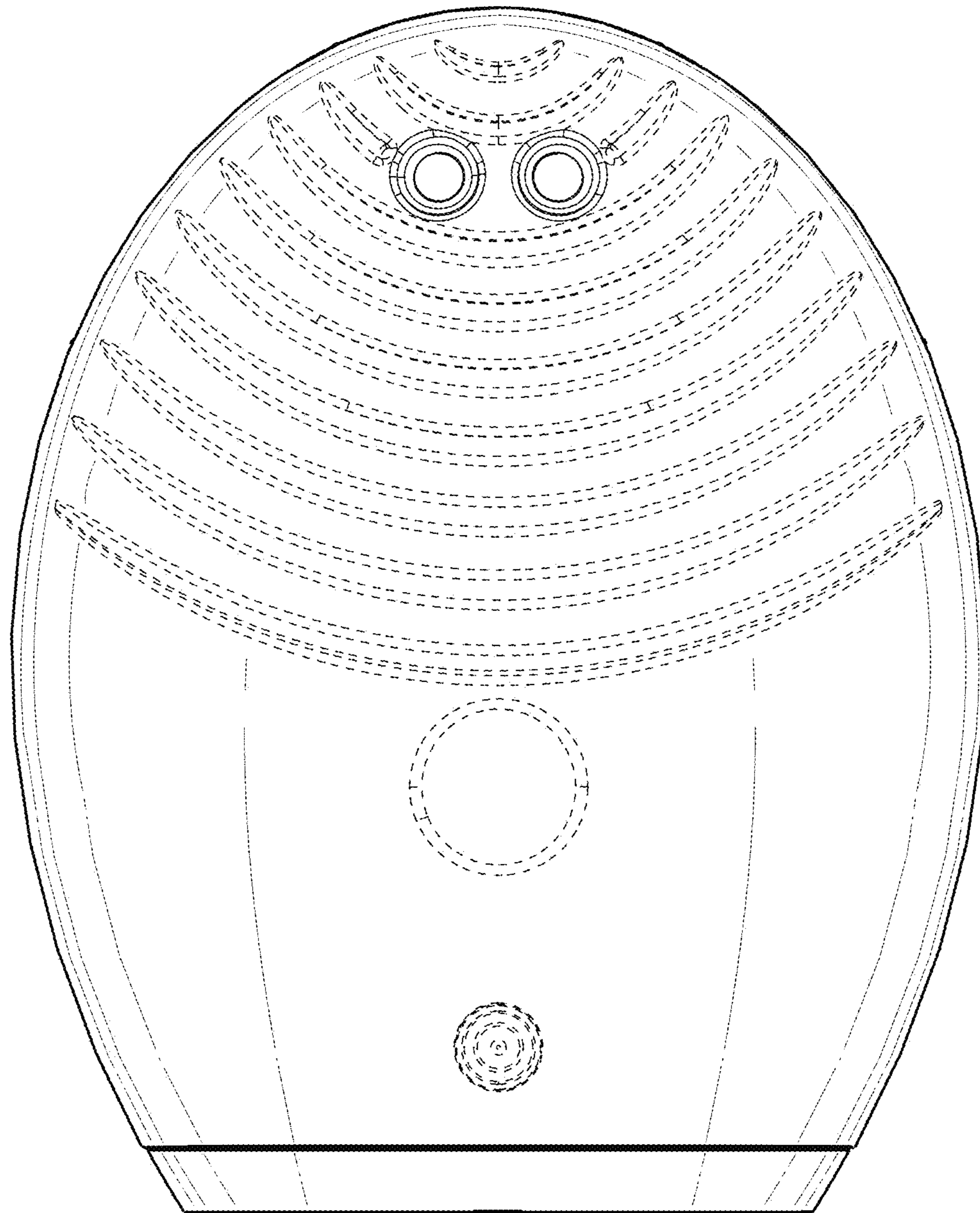

FIG. 10

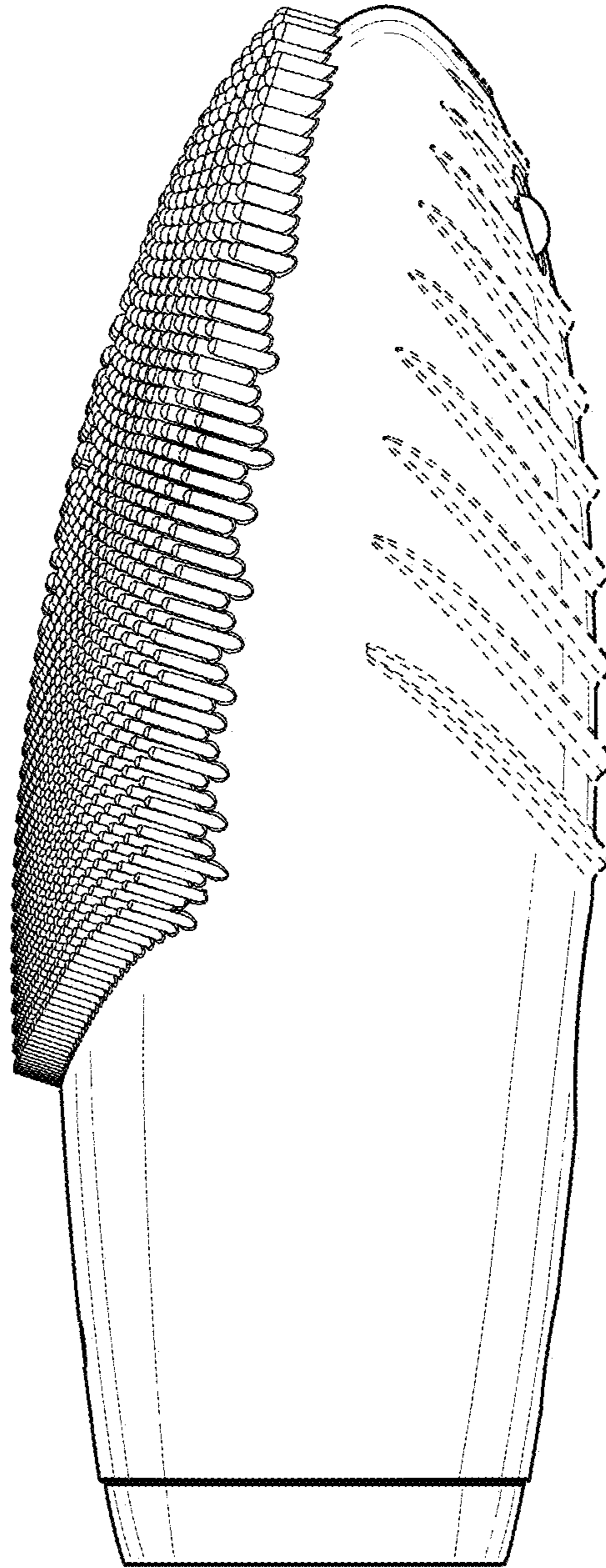

FIG. 11

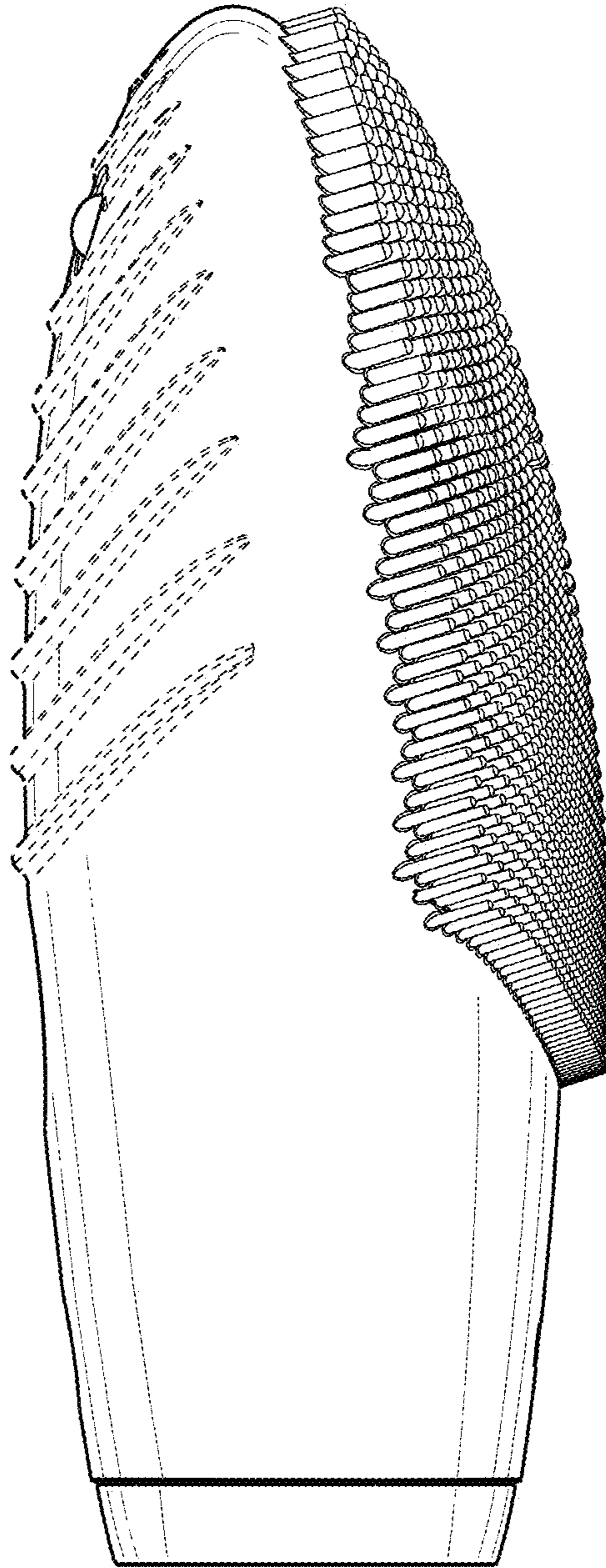

FIG. 12

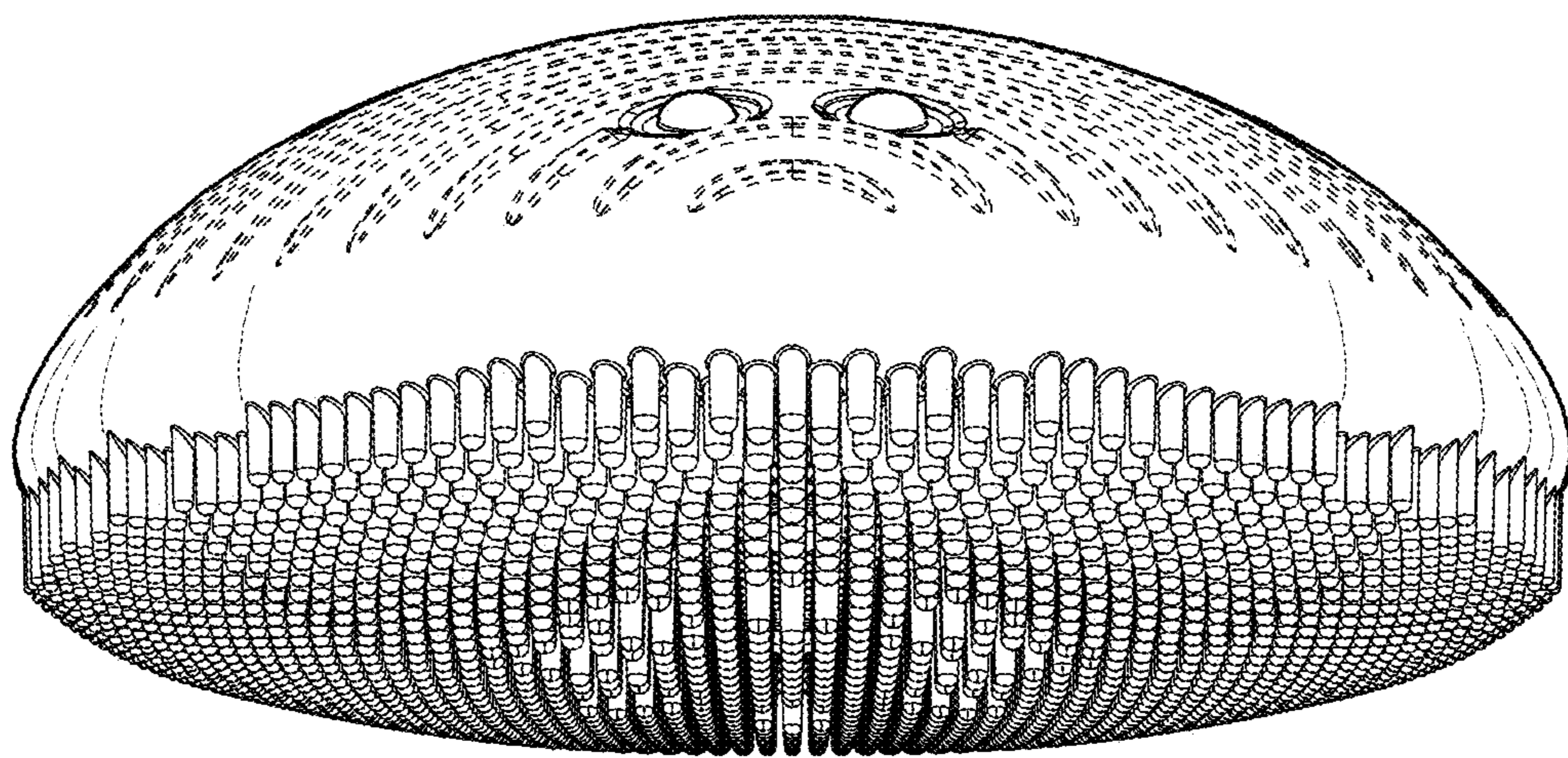

FIG. 13



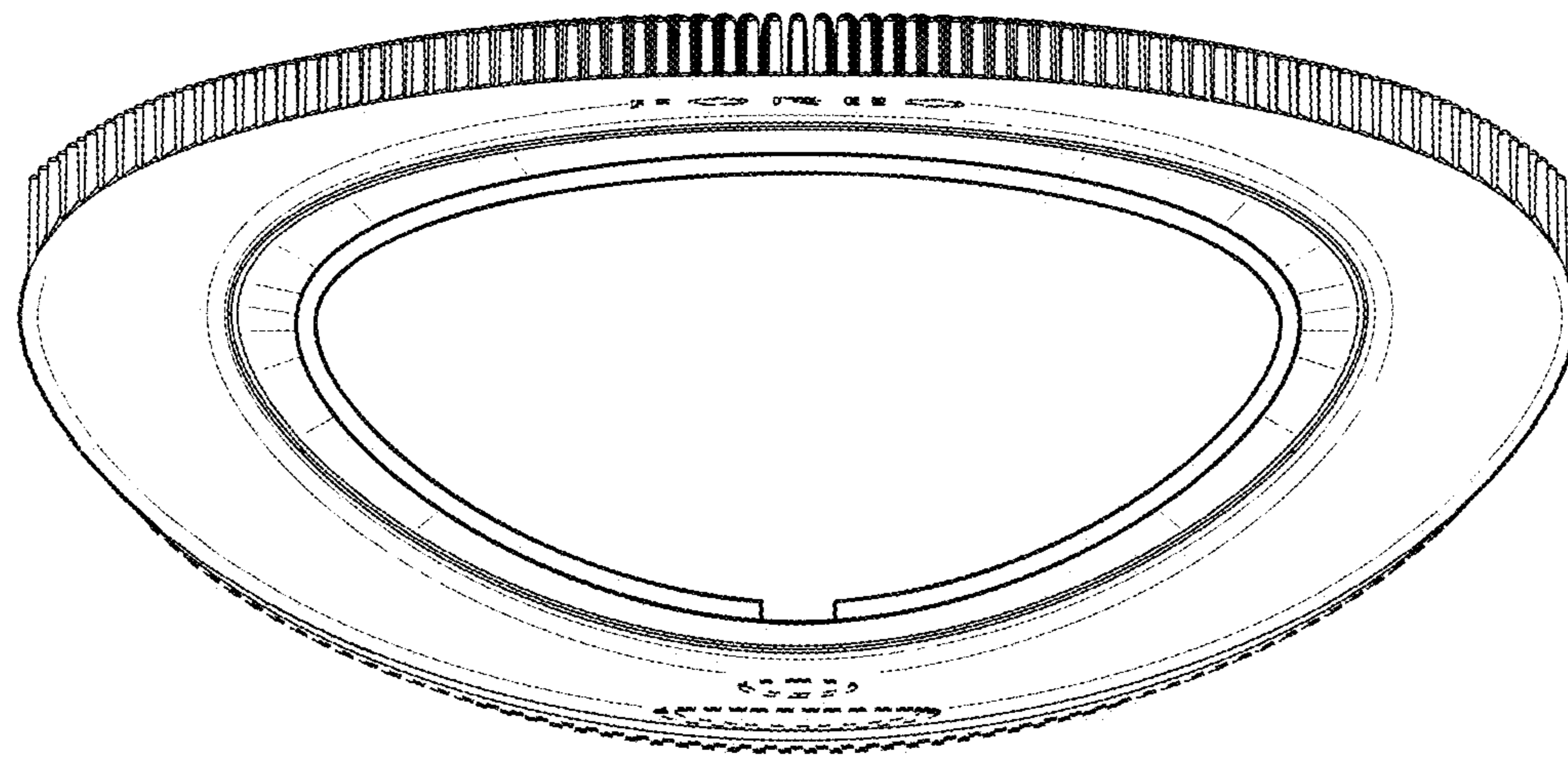

FIG. 14