



US00D898013S

(12) **United States Design Patent** (10) **Patent No.:** **US D898,013 S**
Kim (45) **Date of Patent:** **** *Oct. 6, 2020**

- (54) **CASE FOR ELECTRONIC COMMUNICATIONS DEVICE**
- (71) Applicant: **SPIGEN KOREA CO., LTD.**, Seoul (KR)
- (72) Inventor: **Seungjoo Kim**, Seoul (KR)
- (73) Assignee: **Spigen Korea CO., LTD.**, Seoul (KR)
- (*) Notice: This patent is subject to a terminal disclaimer.
- (**) Term: **15 Years**
- (21) Appl. No.: **29/697,879**
- (22) Filed: **Jul. 11, 2019**

Related U.S. Application Data

- (63) Continuation of application No. 29/612,041, filed on Jul. 27, 2017, now Pat. No. Des. 857,683.
- (51) **LOC (12) Cl.** **14-03**
- (52) **U.S. Cl.**
USPC **D14/250**
- (58) **Field of Classification Search**
USPC D14/250, 203.3-203.7, 439, 238.1, 440, D14/251-253, 447, 217, 240, 248; D3/201, 218, 247, 269, 273, 301, 303; D13/103, 119, 107-108
CPC H04B 1/3888; H04M 1/0283; H04M 1/0202; A45C 1/06; A45C 11/00; A45C 13/02; A45C 2011/002; A45F 2005/026; A45F 2200/0525; A45F 2200/0516
See application file for complete search history.

(56) **References Cited**

U.S. PATENT DOCUMENTS

- 4,877,673 A 10/1989 Eckel et al.
- 4,988,083 A 1/1991 Bradley
- 6,899,946 B2 5/2005 Geary et al.
- D515,809 S * 2/2006 Perella D3/232
- D574,819 S 8/2008 Andre et al.

- D615,077 S 5/2010 Richardson et al.
- D615,536 S 5/2010 Richardson et al.
- D623,639 S 9/2010 Richardson et al.
- D623,640 S 9/2010 Freeman
- D624,910 S * 10/2010 Richardson D14/250
- D638,830 S * 5/2011 Magness D14/250
- 7,938,260 B2 5/2011 Lin
- D643,029 S 8/2011 Feng
- D643,836 S * 8/2011 Smith D14/250
- D643,837 S 8/2011 Smith
- 7,989,085 B2 * 8/2011 Li H04M 1/0283 174/50
- D644,635 S * 9/2011 Richardson D14/250
- D651,202 S 12/2011 Fathollahi
- D662,929 S 7/2012 Fahrendorff et al.
- D669,889 S 10/2012 Li et al.
- D671,930 S 12/2012 Akana et al.
- D673,539 S 1/2013 Magness et al.
- D674,789 S 1/2013 Wen
- D679,695 S 4/2013 Fahrendorff et al.
- D679,698 S 4/2013 Murchison et al.
- D687,027 S 7/2013 Melanson et al.
- 8,509,865 B1 8/2013 LaColla et al.
- D691,122 S 10/2013 Bau
- D691,601 S 10/2013 Murchison et al.
- D694,224 S 11/2013 Wooseung
- D694,759 S 12/2013 Chang et al.
- D696,238 S 12/2013 Murchison et al.
- D696,240 S 12/2013 Kim et al.
- 8,623,494 B2 1/2014 Richardson et al.
- D703,653 S 4/2014 Brubaker et al.
- D703,656 S 4/2014 Witter et al.
- D704,182 S * 5/2014 Smith D14/250
- 8,718,731 B1 5/2014 Tang
- 8,755,852 B2 6/2014 Hyneczek et al.
- D721,071 S 1/2015 Nelson et al.
- D721,686 S 1/2015 Jacob et al.
- D721,693 S 1/2015 Lee et al.
- 8,950,582 B2 2/2015 Chang
- D732,525 S 6/2015 Seo et al.
- D734,747 S 7/2015 Seo et al.
- D735,182 S 7/2015 Watkins et al.
- D739,394 S 9/2015 Rayner et al.
- D741,844 S * 10/2015 Rayner D14/250
- D741,845 S 10/2015 Kim
- D744,995 S * 12/2015 Lerenthal D14/250
- D746,805 S 1/2016 Kim
- 9,264,089 B2 * 2/2016 Tages H04B 1/3888
- D756,343 S 5/2016 Wall et al.
- D763,241 S 8/2016 Kim
- D765,627 S 9/2016 Watt
- D765,632 S * 9/2016 Northrup D14/250
- D765,633 S 9/2016 Northrup et al.

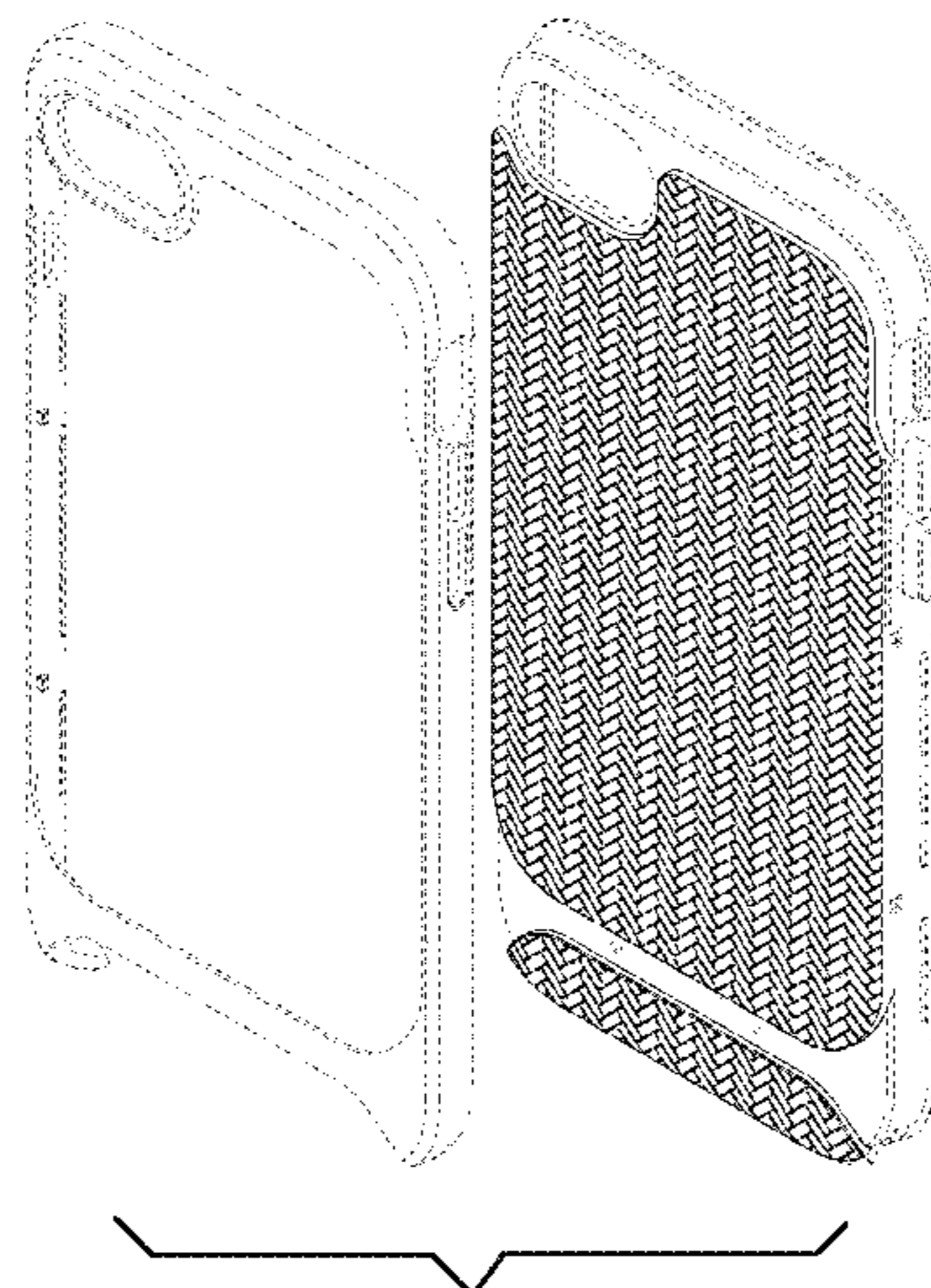

D765,638 S	9/2016	Gaylord et al.	
D765,644 S	9/2016	Witter et al.	
D765,645 S	9/2016	Kim	
D766,819 S	* 9/2016	Gjovik	D13/103
D767,554 S	9/2016	Bertrand et al.	
D771,612 S	11/2016	Roberts et al.	
D771,613 S	11/2016	Poon et al.	
D772,211 S	11/2016	Poon et al.	
D773,445 S	12/2016	Witter et al.	
D774,500 S	* 12/2016	Reese	D14/250
D776,647 S	1/2017	Kim	
D777,157 S	1/2017	Kim	
D777,159 S	1/2017	Lee et al.	
D778,271 S	2/2017	Stump et al.	
D778,892 S	* 2/2017	Fathollahi	D14/250
D781,835 S	3/2017	Kim et al.	
D781,836 S	3/2017	Kim et al.	
D781,837 S	3/2017	Kim et al.	
D781,838 S	3/2017	Kim et al.	
D781,839 S	3/2017	Kim et al.	
D781,840 S	3/2017	Kim et al.	
D782,453 S	3/2017	Kim et al.	
D782,454 S	3/2017	Kim et al.	
D782,460 S	3/2017	Bertrand et al.	
D784,309 S	4/2017	Lee et al.	
D786,848 S	5/2017	Park et al.	
D786,849 S	5/2017	Park et al.	
D786,853 S	5/2017	Friedland et al.	
D787,498 S	* 5/2017	Chen	D14/250
D792,394 S	7/2017	Lee et al.	
D795,237 S	8/2017	Jung et al.	
D797,715 S	9/2017	Kim	
D800,714 S	10/2017	Lee et al.	
D801,323 S	10/2017	Kim	
D808,372 S	1/2018	Brown et al.	
D808,373 S	* 1/2018	Brown	D14/250
D834,581 S	11/2018	Li	
D836,095 S	12/2018	Kim et al.	
D839,860 S	* 2/2019	Kim	D14/250
D840,990 S	2/2019	Kim	
D840,991 S	2/2019	Kim	
D845,290 S	4/2019	Brubaker et al.	
D848,997 S	* 5/2019	Kim	D14/250
D851,638 S	6/2019	Kim et al.	
D851,639 S	* 6/2019	Kim	D14/250
D852,180 S	* 6/2019	Kim	D14/250
D857,683 S	* 8/2019	Kim	D14/250
D863,279 S	* 10/2019	Kim	D14/250
2010/0203931 A1	8/2010	Hynecek et al.	
2015/0119118 A1	4/2015	Ashley et al.	
2015/0141090 A1*	5/2015	Hwan	H04B 1/3888 455/575.8
2016/0106202 A1*	4/2016	Ford	A45C 13/1069 224/267

OTHER PUBLICATIONS

Spigen, “Installation video of SGP Neo Hybrid Case”, <https://www.youtube.com/watch?v=mVASro4MsEg>, Published on Oct. 30, 2009, Downloaded on Feb. 21, 2019.

Spigen, “Installation video of SGP Neo Hybrid2”, https://www.youtube.com/watch?v=y5_NdOVOfZo, Published on May 25, 2010, Downloaded on Feb. 21, 2019.

Spigen, “Installation video of SGP NEO HYBRID EX on iPhone 4”, <https://www.youtube.com/watch?v=Z-IRDIH1w0E>, Published on Sep. 3, 2010, Downloaded on Feb. 21, 2019.

Run Around Tech, “SGP Neo Hybrid Matte Series Case for the iPhone 4”, <https://www.youtube.com/watch?v=fOH74451I-8>, Published on Sep. 22, 2010, Downloaded on Aug. 15, 2018.

“SGP iPhone 4 Case Neo Hybrid Matte Series Gun Metal”, <https://www.amazon.co.uk/dp/B004F1IQ7E>, Date first available at Amazon.co.uk of Dec. 3, 2010, Earliest review date of Dec. 3, 2010, Downloaded on Aug. 15, 2018.

SPIGEN, “Installation video of SGP NEO HYBRID on iPhone 4”, <https://www.youtube.com/watch?v=GnVusVoDrOc>, Published Dec. 15, 2010, downloaded Feb. 21, 2019.

SPIGEN, “Installation video of SGP Case NEO HYBRID EX on Galaxy S2”, <https://www.youtube.com/watch?v=ZPhSIAUxXWg>, Published on Aug. 24, 2011, Downloaded on Feb. 21, 2019.

SPIGEN, “SPIGEN SGP Neo Hybrid 2S iPhone 4s & Neo Hybrid Galaxy S2 LTE”, <https://www.youtube.com/watch?v=SLzDq11dyiY>, Published on Nov. 21, 2011, Downloaded on Feb. 20, 2019.

SPIGEN, “SPIGEN SGP NEO HYBRID case for iphone 4S”, Published on Nov. 22, 2011, Downloaded on Feb. 20, 2019.

SPIGEN, “Neo Hybrid Case for Galaxy S3”, <https://www.youtube.com/watch?v=IgpahRniVku>, Published on Jun. 27, 2012, Downloaded on Feb. 21, 2019.

SPIGEN, “Installation video of SPIGEN SGP Case NEO HYBRID EX on iPhone 5”, <https://www.youtube.com/watch?v=X2GAS9FT6U4>, Published on Oct. 11, 2012, Downloaded on Feb. 20, 2019.

“Spigen Neo Hybrid Galaxy S4 Case with Flexible Inner Protection and Reinforced Hard Bumper Frame for Galaxy S4 2013—Dante Red”, <https://www.amazon.com/Spigen-Hybrid-Flexible-Protection-Reinforced/dp/B00BYJXI1Y>, Earliest review date of May 9, 2013, Downloaded on Jan. 22, 2019.

Metagamers, “Spigen Neo Hybrid iPhone 5 & 5s Case Review”, <https://www.youtube.com/watch?v=vTvTYZfSmal>, Published on Jul. 21, 2013, Downloaded on Feb. 21, 2019.

Danny Winget, “Spigen SGP Neo Hybrid for Galaxy Note 3 Review”, <https://youtube.com/watch?v=W80JtBDSckk>, Published on Nov. 3, 2013, Downloaded on Dec. 20, 2018.

“Spigen Neo Hybrid Galaxy S5 Case with Flexible Inner Protection and Reinforced Hard Bumper Frame for Samsung Galaxy S5 2014—Electric Blue”, <https://www.amazon.com/Spigen-Flexible-Protection-Reinforced-Samsung/dp/B00I3UWJJY>, Earliest review date of Apr. 12, 2014, Downloaded on Jan. 22, 2019.

“Spigen Neo Hybrid iPhone 6 Case with Flexible Inner Protection and Reinforced Hard Bumper Frame for iPhone 6S / iPhone 6—Gunmetal”, <https://www.amazon.com/Spigen-Hybrid-Flexible-Protection-Reinforced/dp/B00LL6ZPXY>, Earliest review date of Aug. 28, 2014, Downloaded on Dec. 18, 2018.

“Spigen Neo Hybrid EX iPhone 6 Case with Flexible Inner Bumper and Reinforced Hard Frame for iPhone 6S/iPhone 6—EX Satin Silver”, <https://www.amazon.com/dp/B00LL6RZ3C>, Earliest review date of Sep. 6, 2014, Downloaded on Dec. 18, 2019.

“Spigen Neo Hybrid Nexus 6 Case with Flexible Inner Protection and Reinforced Hard Bumper Frame for Google Nexus 6 2014—Dante Red”, <https://www.amazon.com/Spigen-Hybrid-Flexible-Protection-Reinforced/dp/B00OH4HKGC>, Earliest review date of Nov. 16, 2014, Downloaded on Dec. 18, 2018.

“Spigen Neo Hybrid Galaxy S6 Case with Flexible Inner Protection and Reinforced Hard Bumper Frame for Galaxy S6 2015—Satin Silver”, <https://www.amazon.com/Spigen-Hybrid-Flexible-Protection-Reinforced/dp/B00QU4Q31A>, Earliest review date of Mar. 6, 2015, Downloaded on Dec. 18, 2018.

“Spigen Neo Hybrid Galaxy S6 Edge Case with Flexible Inner Protection and Reinforced Hard Bumper Frame for Galaxy S6 Edge 2015—Gunmetal”, <https://www.amazon.com/Spigen-Flexible-Protection-Reinforced-Samsung/dp/B00SV635BG>, Earliest review date of Mar. 19, 2015, Downloaded on Dec. 18, 2018.

“Spigen Neo Hybrid CC Galaxy S6 Case with Flexible Inner Casing and Reinforced Hard Bumper Frame for Galaxy S6 2015—Satin Silver”, <https://www.amazon.com/Spigen-Hybrid-Galaxy-Flexible-Reinforced/dp/B00UMDOZLU>, Earliest review date of Mar. 25, 2015, Downloaded on Dec. 18, 2018.

“Spigen Neo Hybrid CC Galaxy S6 Edge Case with Flexible Inner Casing and Reinforced Hard Bumper Frame for Galaxy S6 Edge 2015—Blue Topaz”, <https://www.amazon.com/Spigen-Hybrid-Galaxy-Flexible-Reinforced/dp/B00USAPGKQ>, Earliest review date of Apr. 4, 2015, Downloaded on Dec. 18, 2018.

“Spigen Neo Hybrid Carbon Galaxy S6 Edge Plus Case with Carbon Fiber Design and Reinforced Hard Bumper Frame for Galaxy S6 Edge Plus 2015—Dante Red”, <https://www.amazon.com/Spigen-Hybrid-Carbon-Galaxy-Reinforced/dp/B010MWHZS0>, Earliest review date of Aug. 18, 2015, Downloaded on Dec. 18, 2018.

“Spigen Neo Hybrid Crystal Galaxy Note 5 Case with Flexible Inner Casing and Reinforced Hard Bumper Frame for Galaxy Note 5 2015—Champagne Gold”, <https://www.amazon.com/Spigen->

Hybrid-Crystal-Flexible-Reinforced/dp/B010MWIG1K, Earliest review date of Aug. 22, 2015, Downloaded on Dec. 18, 2018.

“iPhone 6s Case, Spigen [Neo Hybrid EX] PREMIUM BUMPER [Rose Gold] Clear TPU / PC Frame Slim Dual Layer Premium Case for iPhone 6 (2014) / 6s (2015)—Rose Gold (SGP11725)”, <https://www.amazon.com/Spigen-Hybrid-iPhone-Flexible-Reinforced/dp/B012PKV30S>, Earliest review date of Aug. 28, 2015, Downloaded on Dec. 18, 2018.

“Spigen Neo Hybrid Carbon iPhone 6s Case with Carbon Fiber Design and Reinforced Hard Bumper Frame for Apple Phone 6s / iPhone 6 (2015)—Reventon Yellow”, <https://www.amazon.com/Spigen-Hybrid-Carbon-iPhone-Reinforced/dp/B010MVJ5O8>, Earliest review date of Sep. 1, 2015, Downloaded on Dec. 18, 2018.

“Spigen Neo Hybrid iPhone 6S Case with Flexible Inner Protection and Reinforced Hard Bumper Frame for iPhone 6S 2015—Gunmetal”, <https://www.amazon.com/Spigen-Hybrid-Flexible-Protection-Reinforced/dp/B010MVIZTE>, Earliest review date of Sep. 1, 2015, Downloaded on Dec. 18, 2018.

“Spigen Neo Hybrid EX iPhone 6S Plus Case with Flexible Inner Bumper and Reinforced Hard Frame for iPhone 6S Plus/iPhone 6 Plus—Champagne Gold”, <https://www.amazon.com/Spigen-Hybrid-iPhone-Flexible-Reinforced/dp/B010MVRR16>, Earliest review date of Sep. 4, 2015, Downloaded on Dec. 18, 2018.

“iPhone 6S Plus Case, Caseology [Wavelength Series] Slim Fit Military-Grade Drop Protection [Navy Blue] for Apple Phone 6S Plus (2015) & iPhone 6 Plus (2014)”, <https://www.amazon.com/iPhone-Caseology-Wavelength-Military-Grade-Protection/dp/B013W2C77G>, Earliest review date of Sep. 10, 2015, Downloaded on Mar. 13, 2018.

“Spigen Neo Hybrid Carbon iPhone 6S Plus Case with Carbon Fiber Design and Reinforced Hard Bumper Frame for Phone 6S Plus 2015—Gunmetal”, <https://www.amazon.com/Spigen-Hybrid-Carbon-iPhone-Reinforced/dp/B010MVRGMQ>, Earliest review date of Sep. 11, 2015, Downloaded on Dec. 18, 2018.

“iPhone SE Case, for Apple iPhone 5S/5 Case, ROCK [Royce] Antiscratch Drop Protection Slim Fit Dual Layered Heavy Duty Armor Hybrid Hard PC + Soft TPU Protective Shell Case—Champagne Gold/Black”, <https://www.amazon.com/ROCK-Anti-scratch-Protection-Layered-Protective/dp/B014A8AM7I>, Earliest review date of Oct. 16, 2015, Downloaded on Jan. 30, 2017.

“Spigen Neo Hybrid EX Nexus 6P Case with Flexible Inner Bumper and Reinforced Hard Frame for Nexus 6P 2015—Gunmetal”, <https://www.amazon.com/Spigen-Hybrid-Flexible-Bumper-Reinforced/dp/B018418Z4W>, Earliest review date of Oct. 20, 2015, Downloaded on Dec. 18, 2018.

George Tinari, “Caseology review: Testing 4 of the nicest iPhone 6s cases available”, <https://www.cultofmac.com/399325/caseology-review>, Published on Nov. 28, 2015, Downloaded on Jan. 30, 2017.

“Spigen Neo Hybrid Crystal Galaxy S7 Edge Case with Flexible Inner Casing and Reinforced Hard Bumper Frame for Samsung Galaxy S7 Edge 2016—Satin Silver”, <https://www.amazon.com/Spigen-Crystal-Flexible-Reinforced-Samsung/dp/B01A7IDQV4>, Earliest review date of Feb. 22, 2016, Downloaded on Dec. 18, 2018.

“Spigen Neo Hybrid Galaxy S7 Case with Flexible Inner Protection and Reinforced Hard Bumper Frame for Samsung Galaxy S7 2016—Gunmetal”, <https://www.amazon.com/Spigen-Flexible-Protection-Reinforced-Samsung/dp/B01B1I6J0E>, Earliest review date of Feb. 27, 2016, Downloaded on Dec. 18, 2018.

“Spigen Neo Hybrid Galaxy S7 Edge Case with Flexible Inner Protection and Reinforced Hard Bumper Frame for Samsung Galaxy S7 Edge 2016—Satin Silver”, <https://www.amazon.com/Spigen-Flexible-Protection-Reinforced-Samsung-x/dp/B01B1I6JMM>, Earliest review date of Feb. 27, 2016, Downloaded on Dec. 18, 2018.

“Spigen Neo Hybrid Crystal Galaxy S7 Case with Flexible Inner Casing and Reinforced Hard Bumper Frame for Samsung Galaxy S7 2016—Champagne Gold”, <https://www.amazon.com/Spigen-Crystal-Flexible-Reinforced-Samsung/dp/B01B29WCOY>, Earliest review date of Mar. 3, 2016, Downloaded on Dec. 18, 2018.

“Gold Apple iPhone 5 5S Hybrid Shockproof Hard Bumper Soft Case Cover Skin”, <https://web.archive.org/web/20160321221419/https://www.nywatchstore.com/goapip55shys.html>, first archived on Mar. 21, 2016 at Wayback Machine, Downloaded on Jan. 22, 2019.

“ROCK PC+TPU Neo Hybrid Durable Slim Armor cover case for iPhone X 6S 5S SE Plus”, <https://www.ebay.com/itm/ROCK-PC-TPU-Neo-Hybrid-Durable-Slim-Armor-cover-case-for-iphone-X-6S-5S-SE-Plus-/111952466831>, listing first revised on Mar. 30, 2016, Downloaded on Mar. 9, 2018.

“Spigen Neo Hybrid iPhone SE Case with Flexible Inner Protection and Reinforced Hard Bumper Frame for iPhone SE 2016—Gunmetal”, <https://www.amazon.com/dp/B01BEJBBSK>, Earliest review date of Apr. 6, 2016, Downloaded on Dec. 20, 2018.

“Spigen Neo Hybrid Crystal iPhone SE Case with Flexible Inner Casing and Reinforced Hard Bumper Frame for iPhone SE 2016—Rose Gold”, <https://www.amazon.com/Spigen-Hybrid-Crystal-Flexible-Reinforced/dp/B01BEJB7II>, Earliest review date of Apr. 7, 2016, Downloaded on Dec. 18, 2018.

“Spigen Neo Hybrid Crystal LG G5 Case with Flexible Inner Casing and Reinforced Hard Bumper Frame for LG G5 2016—Champagne Gold”, <https://www.amazon.com/Spigen-Hybrid-Crystal-Flexible-Reinforced/dp/B01B1GQKIC>, Earliest review date of Apr. 17, 2016, Downloaded on Dec. 18, 2018.

* cited by examiner

Primary Examiner — Carla J Wright

(74) *Attorney, Agent, or Firm* — Heedong Chae; Lucem, PC

(57)

CLAIM

The ornamental design for a case for electronic communications device, as shown and described.

DESCRIPTION

FIG. 1 is a front perspective view of a case for electronic communications device showing my new design;

FIG. 2 is a rear perspective view thereof;

FIG. 3 is a front elevational view thereof;

FIG. 4 is a rear elevational view thereof;

FIG. 5 is a left side elevational view thereof;

FIG. 6 is a right side elevational view thereof;

FIG. 7 is a top plan view thereof;

FIG. 8 is a bottom plan view thereof;

FIG. 9 is a front perspective view showing the inner shell component of the case separately for clarity of disclosure;

FIG. 10 is a rear perspective view showing the inner shell component of the case separately for clarity of disclosure;

FIG. 11 is a front perspective view showing the environmental outer frame component of the case in isolation for clarity of disclosure;

FIG. 12 is a rear perspective view showing the environmental outer frame component of the case in isolation for clarity of disclosure;

FIG. 13 is an exploded front perspective view showing the components of the case separated for clarity of disclosure;

FIG. 14 is an exploded rear perspective view showing the components of the case separated for clarity of disclosure;

FIG. 15 is an enlarged detail view of the encircled portion of the design from FIG. 2; and,

FIG. 16 is an enlarged detail view of the encircled portion of the design from FIG. 4.

The dot-dash broken lines in FIGS. 2, 4, 15 and 16, encircle the portions of the claimed design that are shown on an enlarged scale in FIGS. 15 and 16.

The dashed broken lines throughout the drawing figures depict portions of the case for electronic communications device that form no part of the claimed design.

FIG. 1

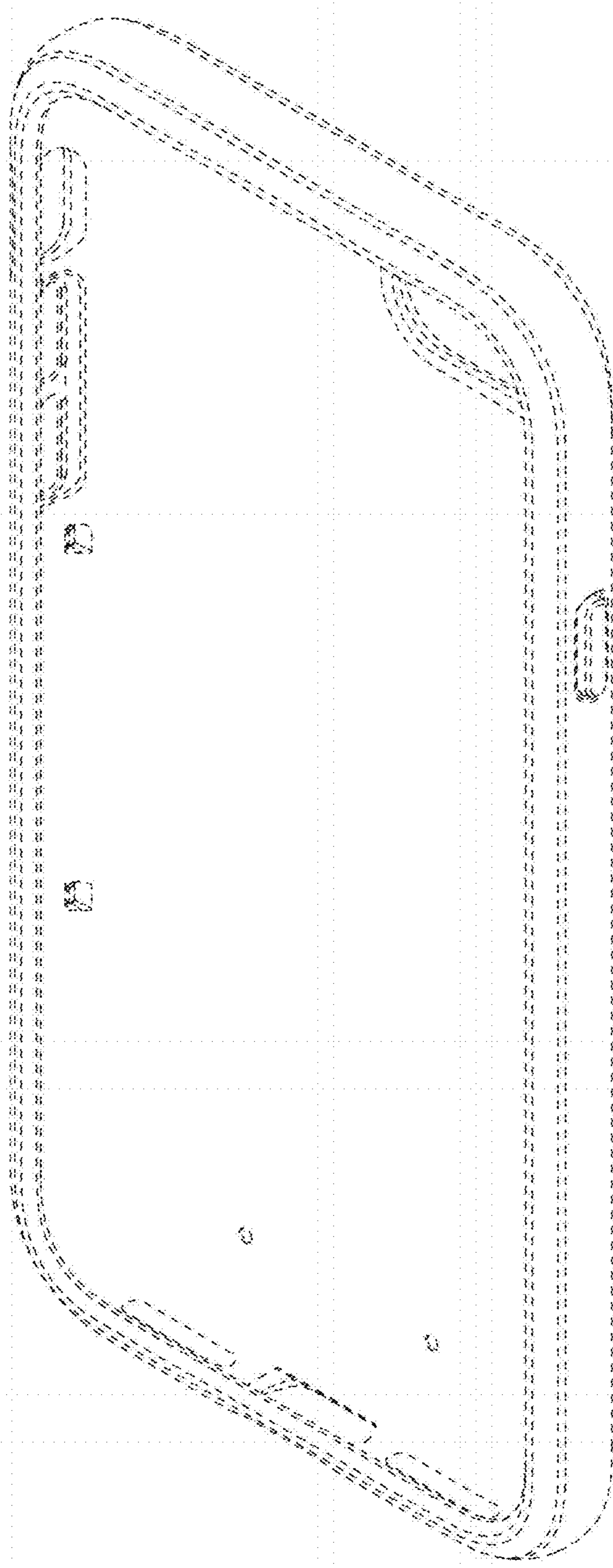

FIG. 2

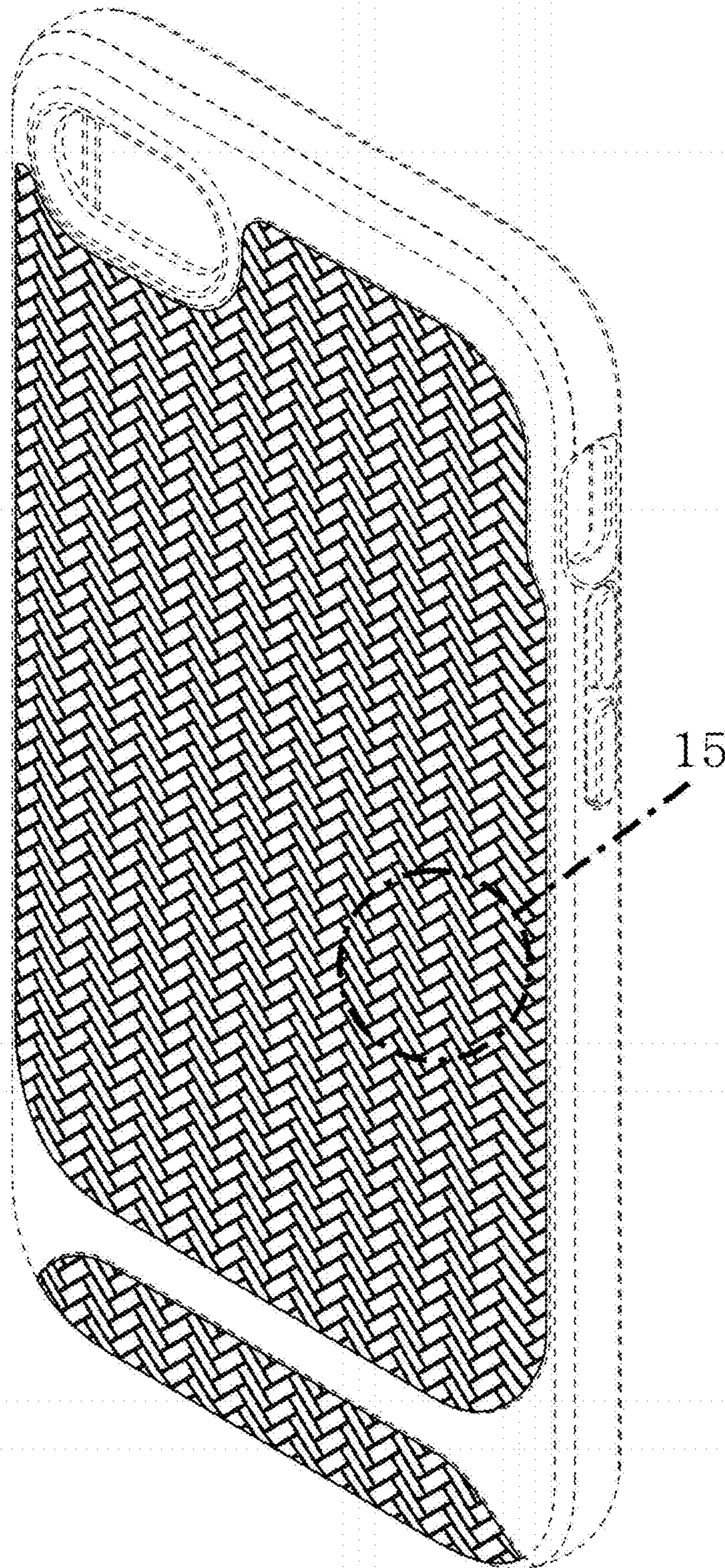

FIG. 3

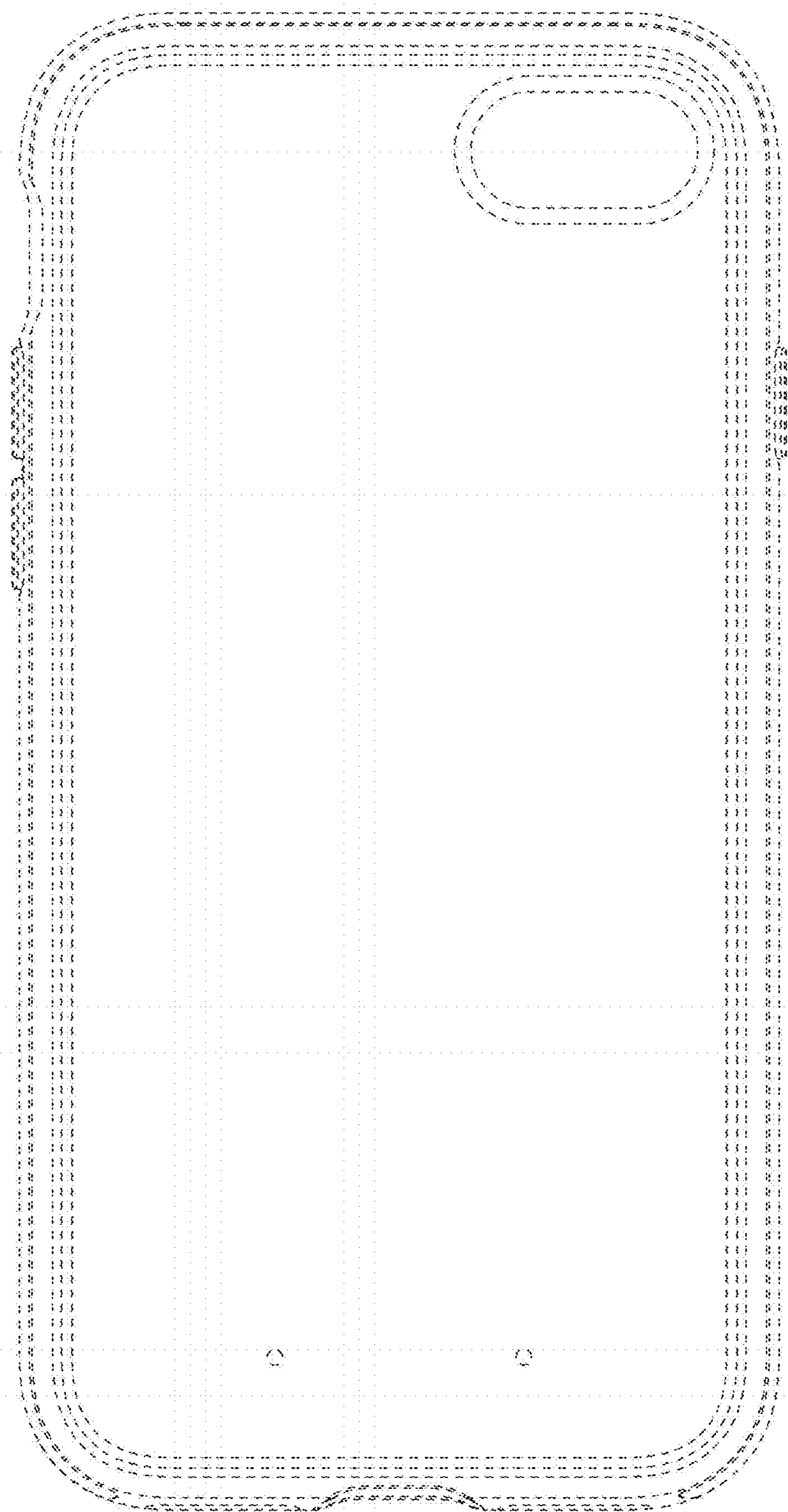

FIG. 4

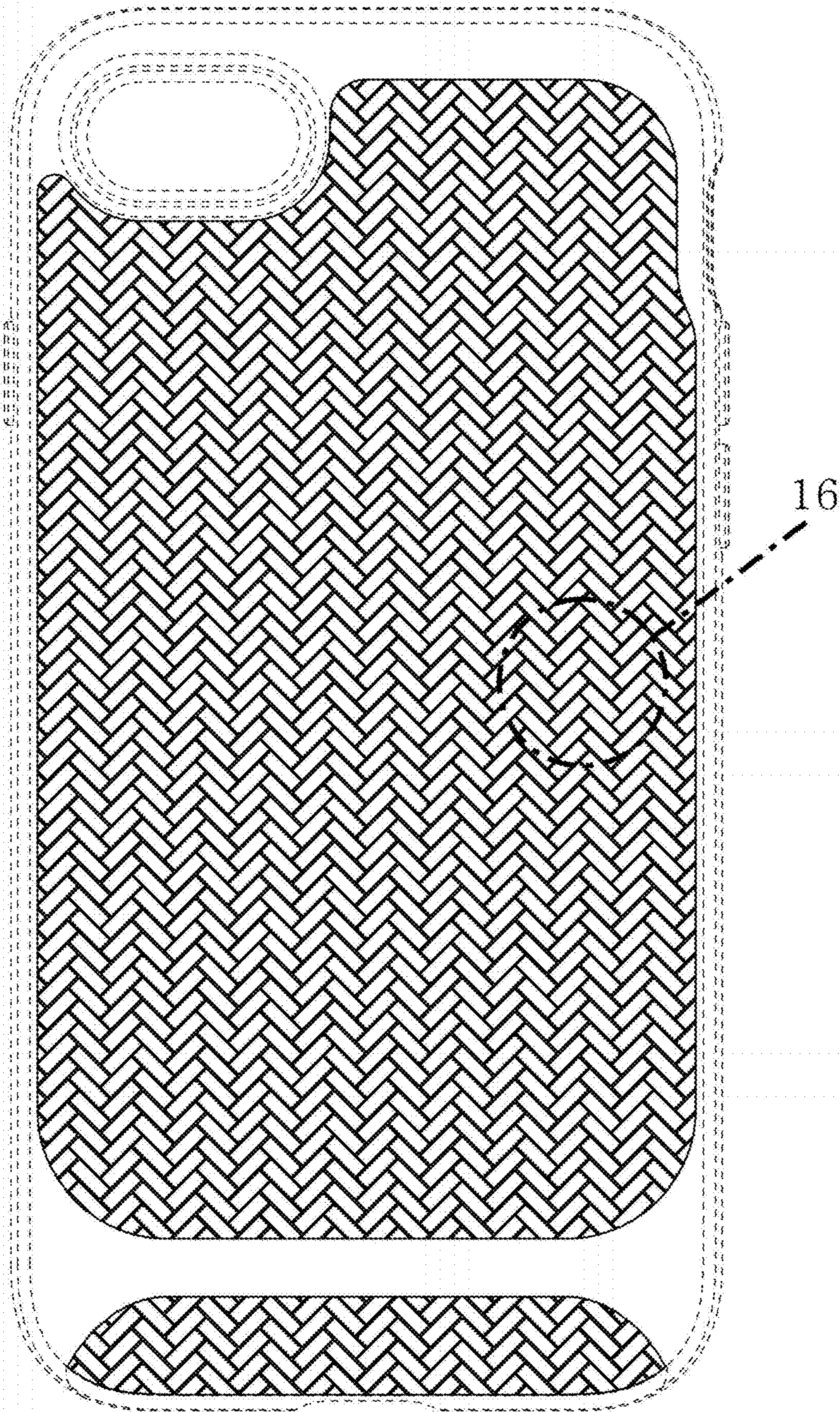

FIG. 5

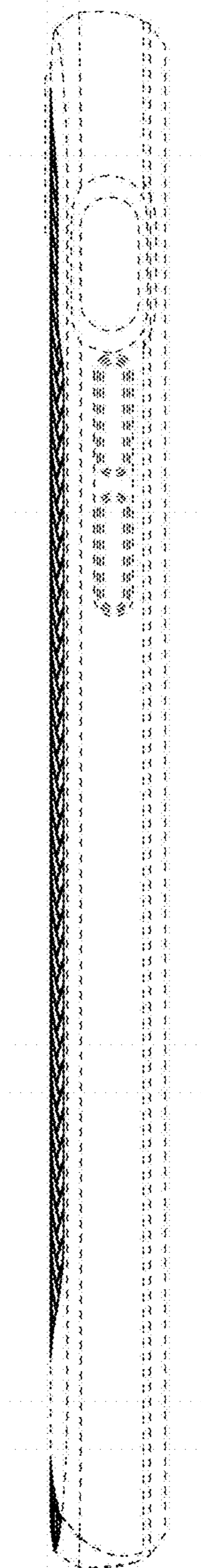

FIG. 6

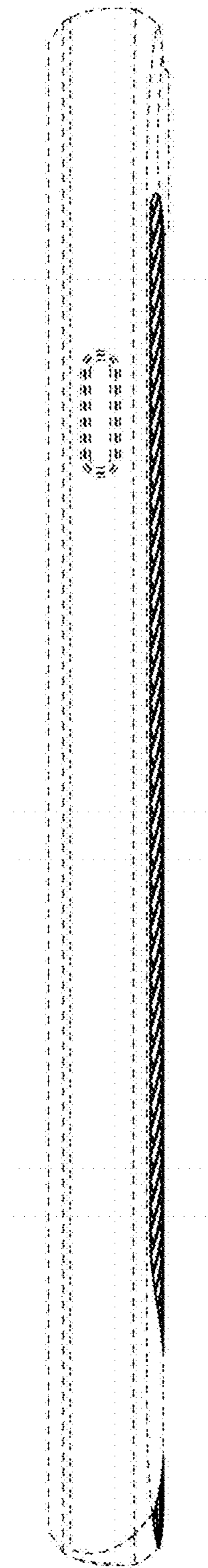

FIG. 7

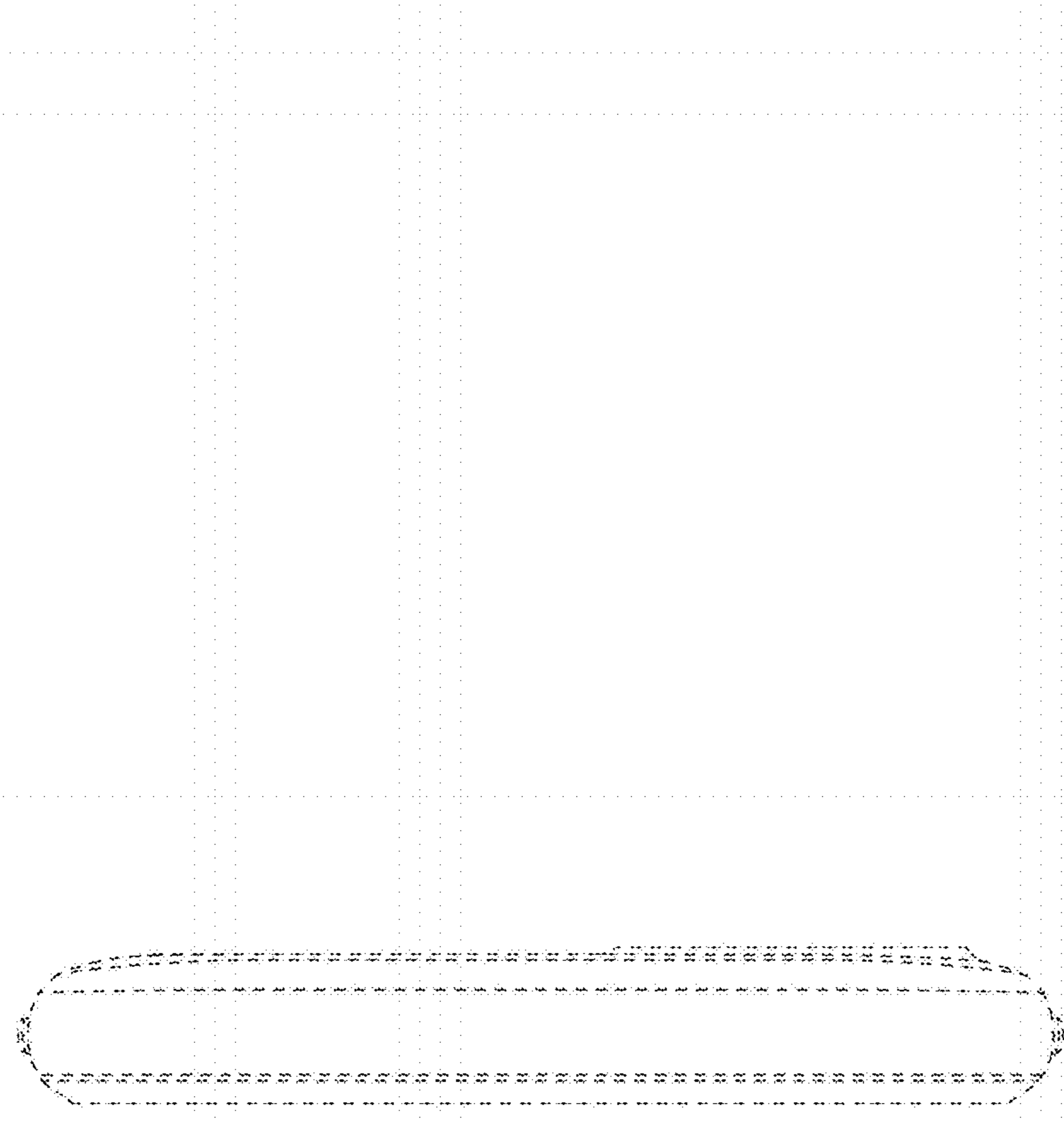

FIG. 8

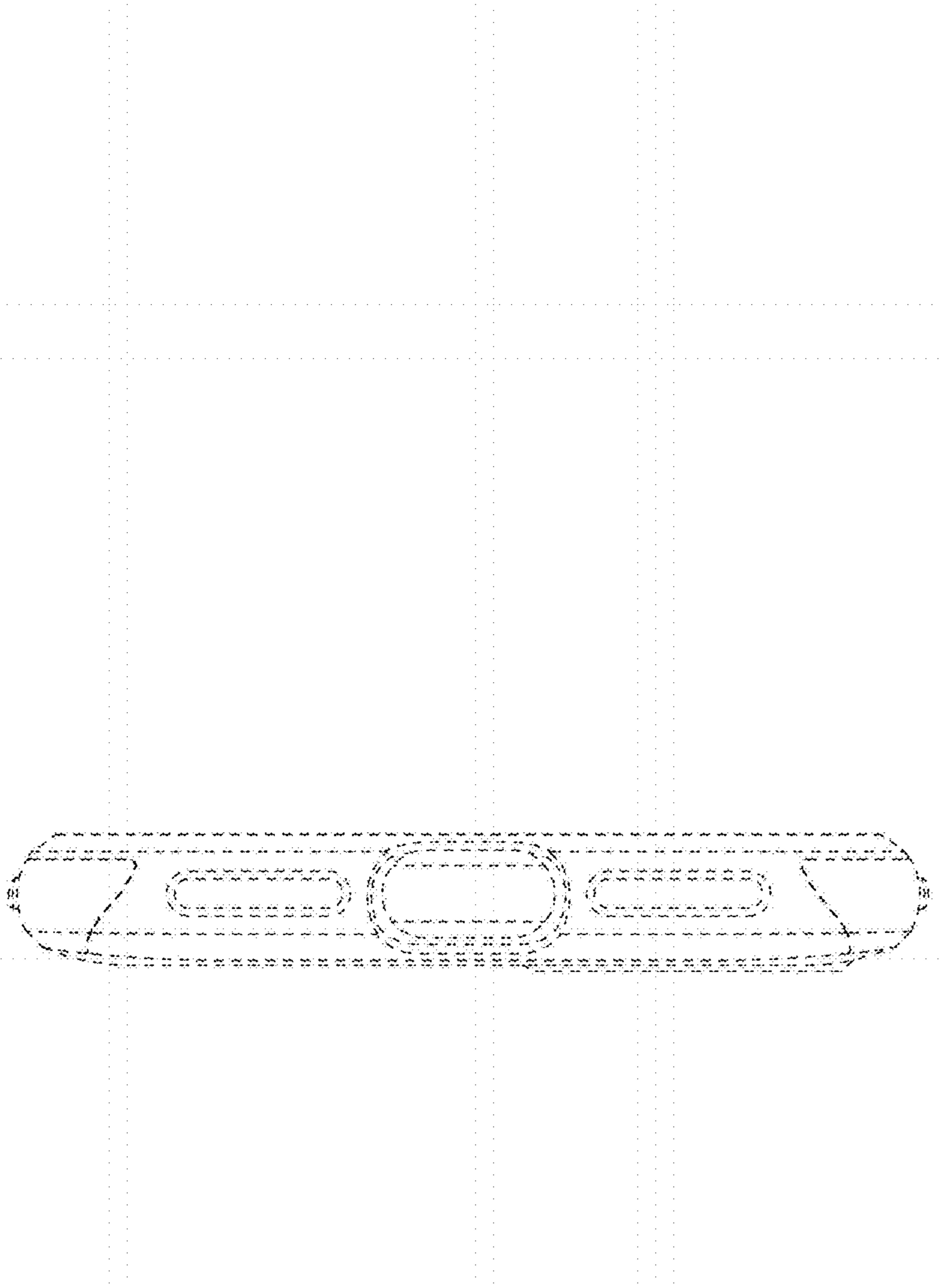

FIG. 9

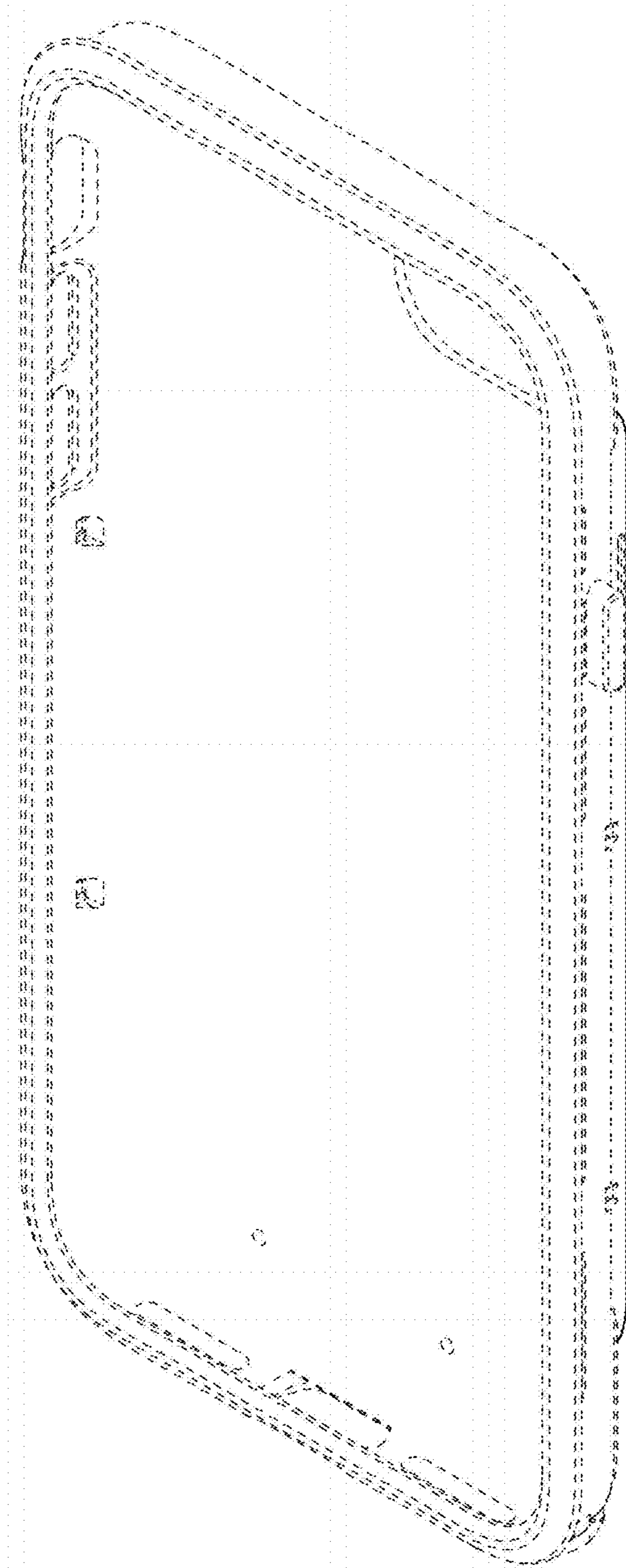

FIG. 10

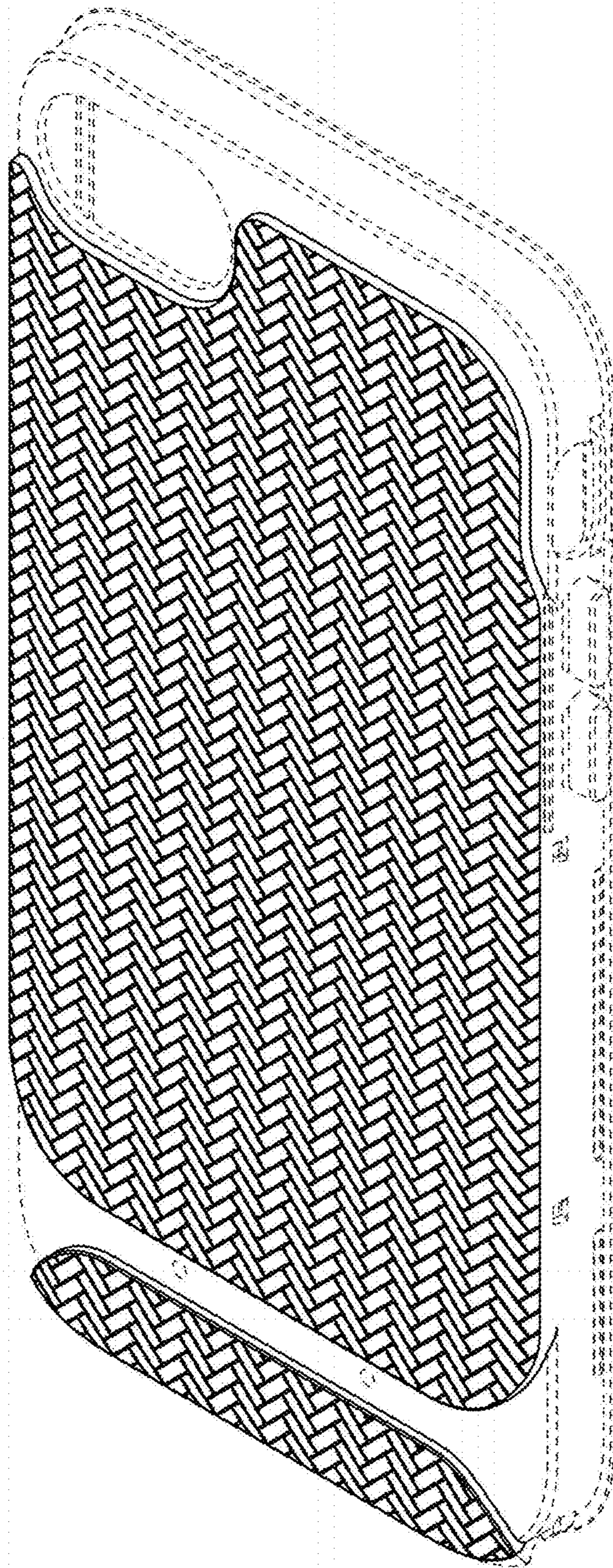

FIG. 11

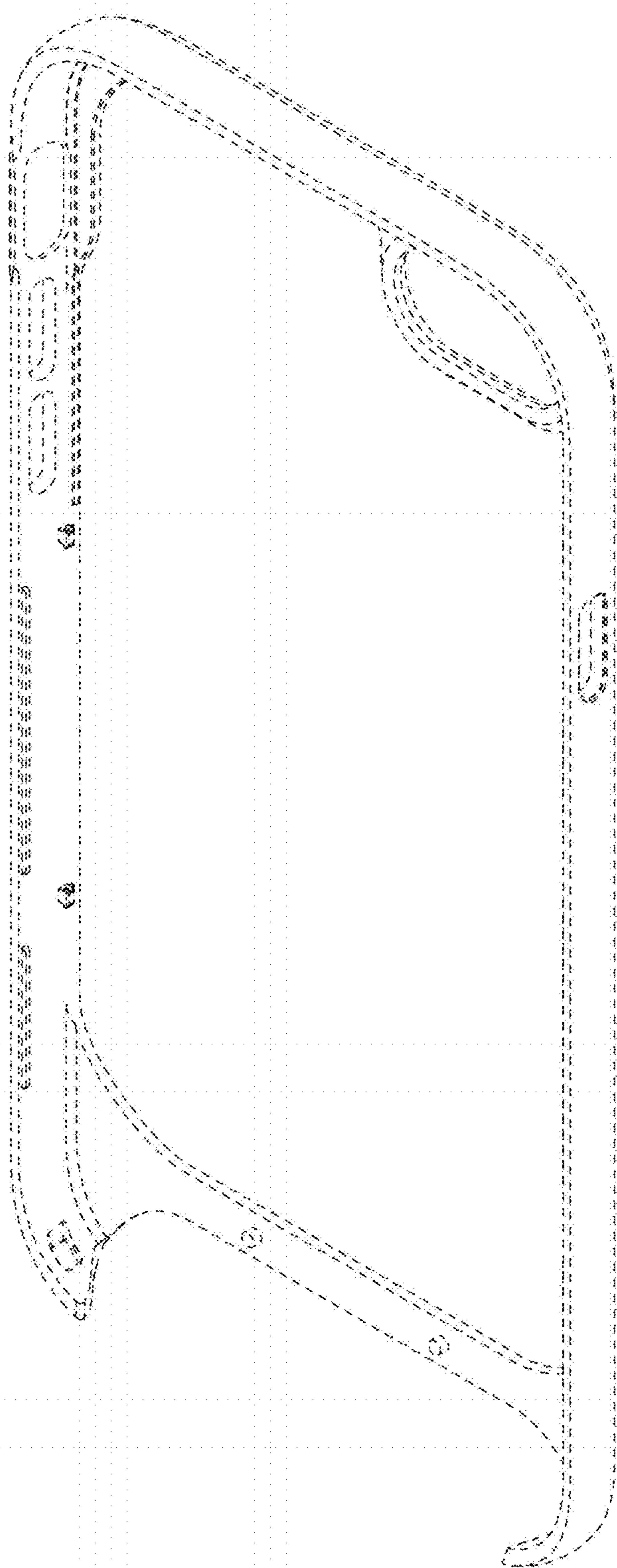

FIG. 12

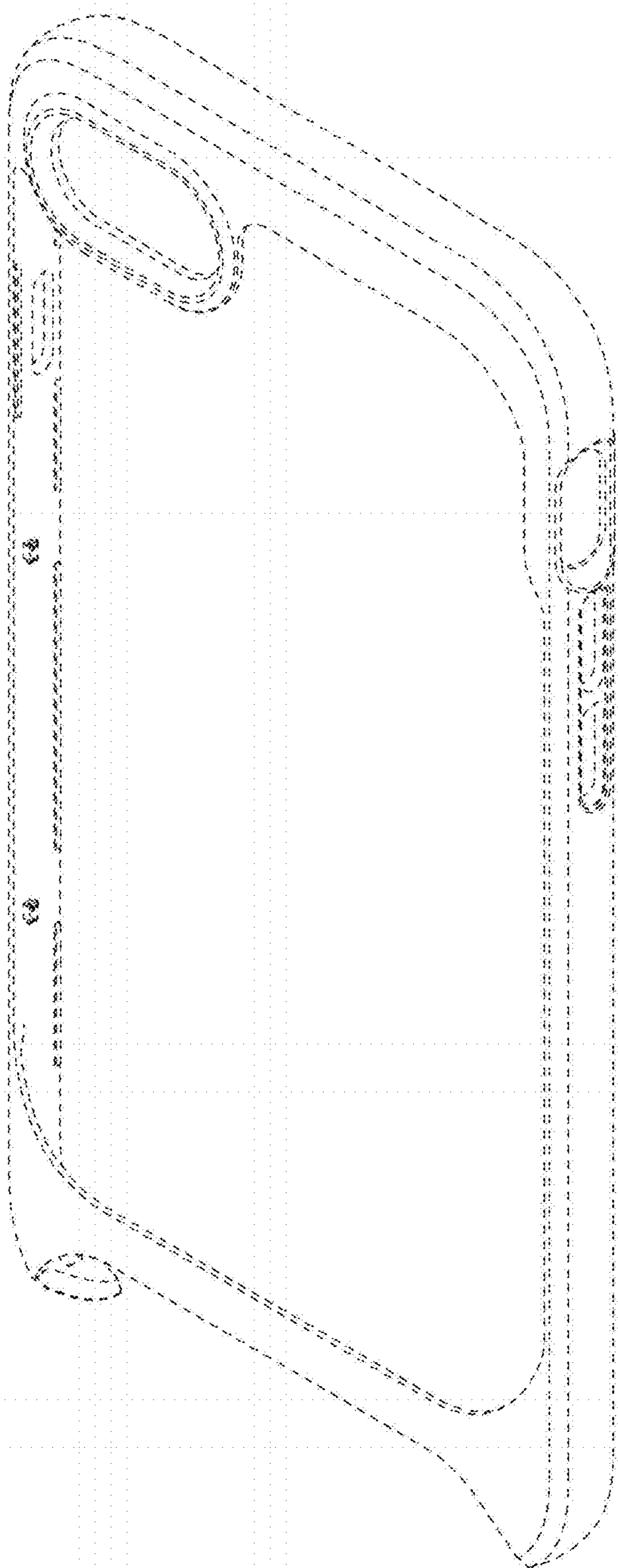

FIG. 13

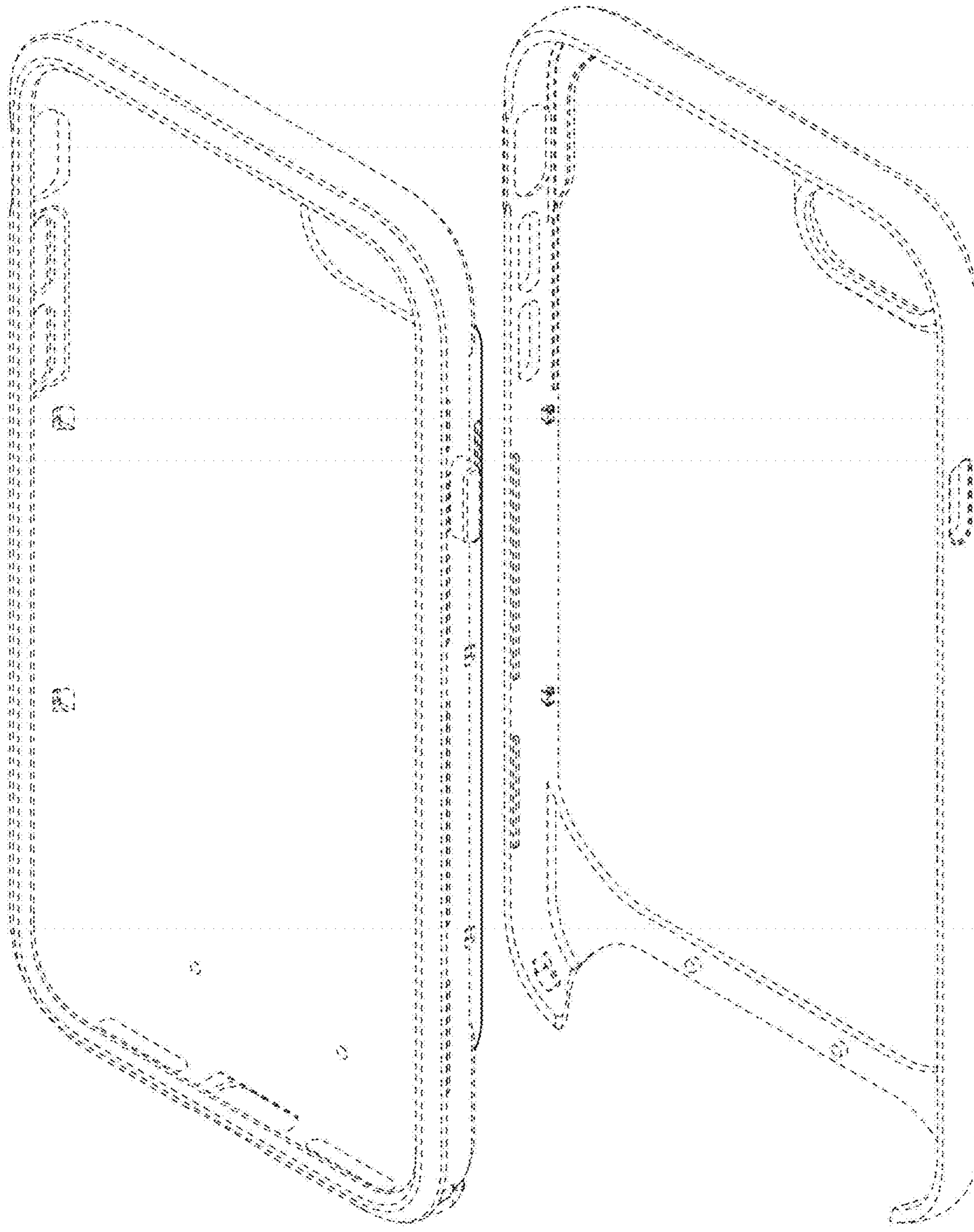

FIG. 14

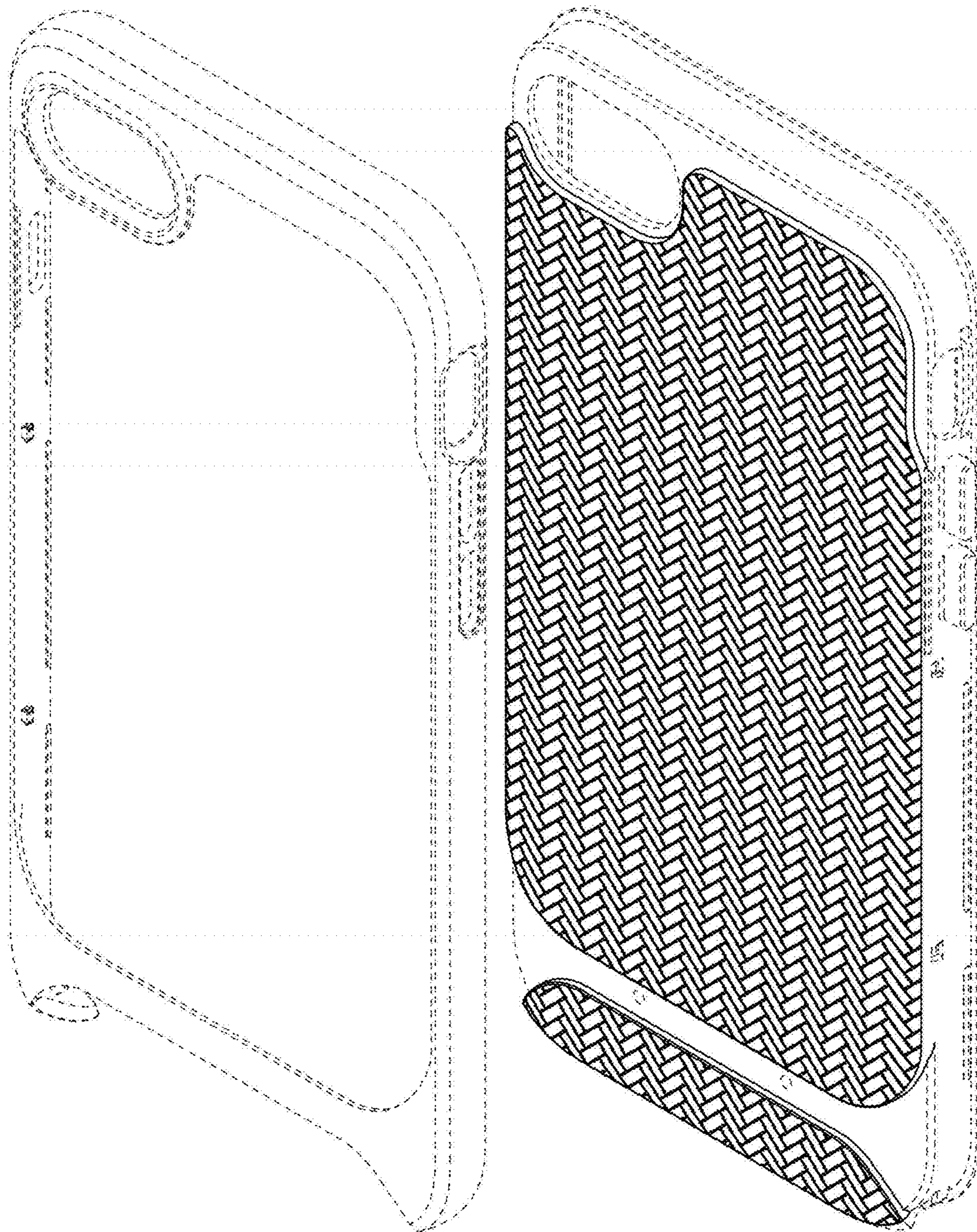

FIG. 15

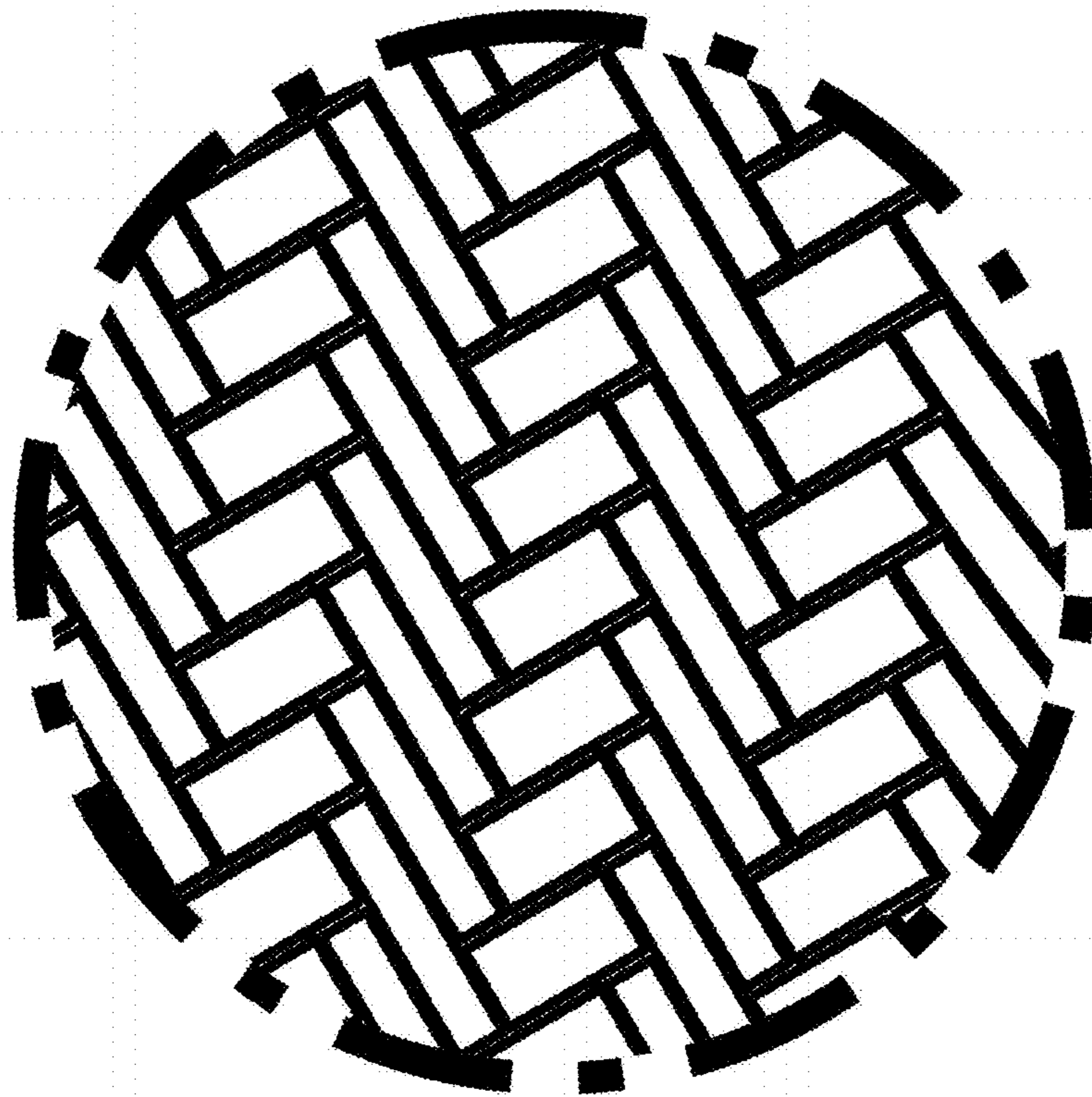

FIG. 16

