



US00D897910S

(12) **United States Design Patent** (10) **Patent No.:** **US D897,910 S**
Dickerson et al. (45) **Date of Patent:** **** Oct. 6, 2020**

(54) **WATER PROOF STROLLER COVER**

(71) Applicants: **Soumaya Dickerson**, New York, NY (US); **Hilda Bergman**, New York, NY (US)

(72) Inventors: **Soumaya Dickerson**, New York, NY (US); **Hilda Bergman**, New York, NY (US)

(**) Term: **15 Years**

(21) Appl. No.: **29/686,039**

(22) Filed: **Apr. 2, 2019**

(51) **LOC (12) Cl.** **12-12**

(52) **U.S. Cl.**
USPC **D12/133**

(58) **Field of Classification Search**
USPC **D12/128-133**

(Continued)

(56) **References Cited**

U.S. PATENT DOCUMENTS

5,074,616 A * 12/1991 Smith A47C 7/66
297/184.13
6,012,184 A * 1/2000 Childers A47D 15/00
5/416

(Continued)

Primary Examiner — Charles D Hanson

(74) *Attorney, Agent, or Firm* — David Postolski, Esq.;
Gearhart Law LLC

(57) **CLAIM**

The ornamental design for a water proof stroller cover, as shown and described.

DESCRIPTION

FIG. 1 is a front perspective view of a water proof stroller cover of the present invention.

FIG. 2 is a front view of the water proof stroller cover in FIG. 1.

FIG. 3 is a rear view of the water proof stroller cover in FIG. 1.

FIG. 4 is a right side view of the water proof stroller cover in FIG. 1.

FIG. 5 is a left side view of the water proof stroller cover in FIG. 1.

FIG. 6 is a top view of the water proof stroller cover in FIG. 1.

FIG. 7 is a bottom view of the water proof stroller cover in FIG. 1.

FIG. 8 is a front perspective view of a waterproof stroller cover of the present invention.

FIG. 9 is a front view of the water proof stroller cover in FIG. 8.

FIG. 10 is a rear view of the water proof stroller cover in FIG. 8.

FIG. 11 is a right side view of the water proof stroller cover in FIG. 8.

FIG. 12 is a left side view of the water proof stroller cover in FIG. 8.

FIG. 13 is a top view of the water proof stroller cover in FIG, 8.

FIG. 14 is a bottom view of the water proof stroller cover in FIG. 8.

FIG. 15 is a front perspective view of a water proof stroller cover of the present invention.

FIG. 16 is a front view of the water proof stroller cover in FIG. 15.

FIG. 17 is a rear view of the water proof stroller cover in FIG. 15.

FIG. 18 is a right side view of the water proof stroller cover in FIG. 15.

FIG. 19 is a left side view of the water proof stroller cover in FIG. 15.

FIG. 20 is a top view of the water proof stroller cover in FIG, 15; and,

FIG. 21 is a bottom view of the water proof stroller cover in FIG. 15.

The broken lines in the figures illustrate portions of the water proof stroller cover that form no part of the claimed design.

1 Claim, 21 Drawing Sheets

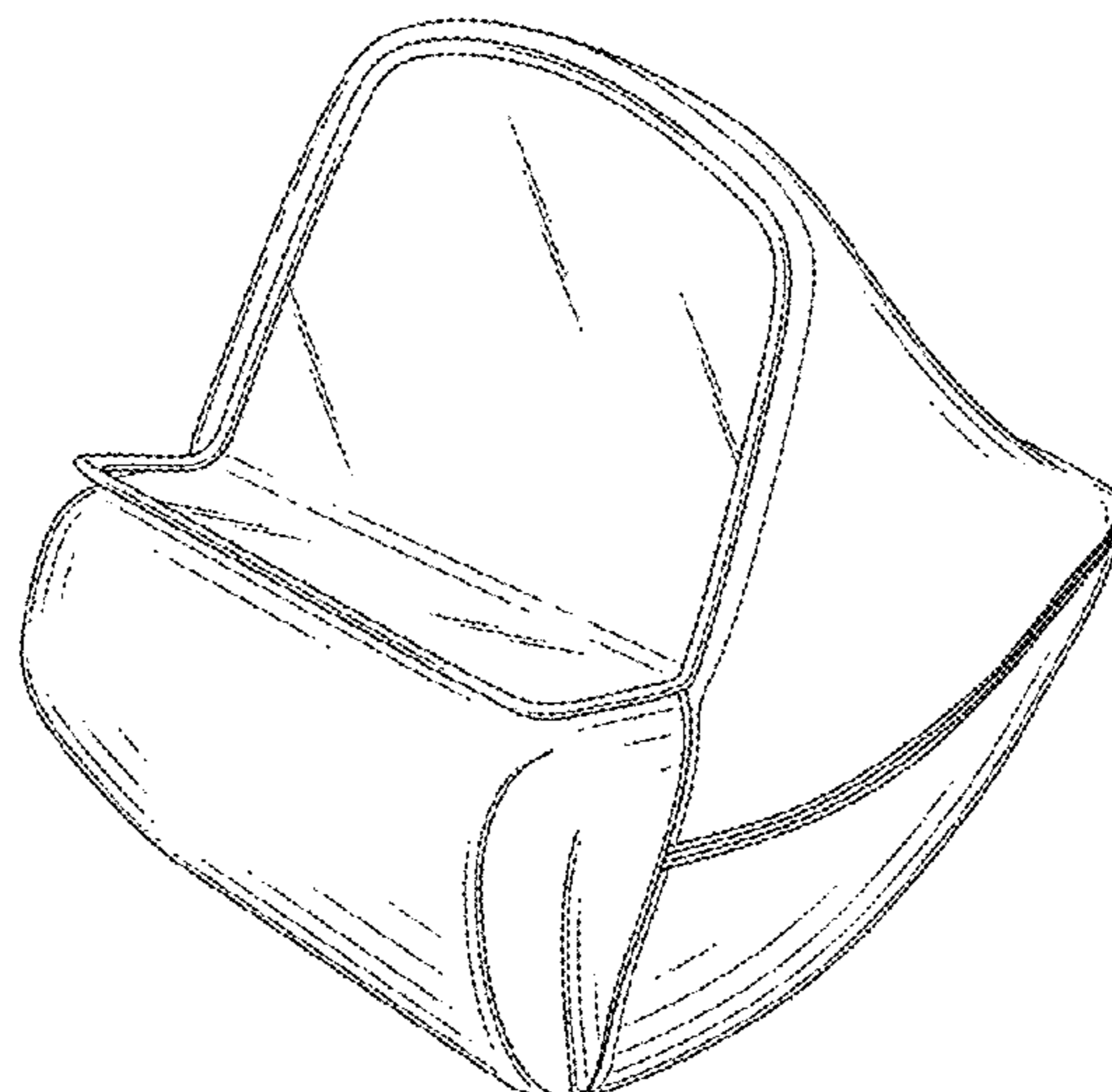

(58) **Field of Classification Search**

CPC B62B 7/00-04; B62B 9/00-28
See application file for complete search history.

(56) **References Cited**

U.S. PATENT DOCUMENTS

6,012,756 A * 1/2000 Clark-Dickson B62B 9/142
296/107.02
6,224,073 B1 * 5/2001 Au B62B 9/142
280/47.38
7,354,049 B2 * 4/2008 Schmidt A45C 9/00
280/33.993
D619,939 S * 7/2010 Olsen D12/133
9,463,821 B1 * 10/2016 Critchley B62B 9/10
10,058,194 B2 * 8/2018 Tebbe A47D 15/00
2004/0129306 A1 * 7/2004 Jefferson B62B 9/142
135/96
2005/0275257 A1 * 12/2005 McGregor B60N 2/2842
297/219.12
2010/0066119 A1 * 3/2010 Levine B62B 9/142
296/136.07
2012/0286547 A1 * 11/2012 Gibbons A47D 13/02
297/184.11
2017/0253261 A1 * 9/2017 Therrien B62B 9/142

* cited by examiner

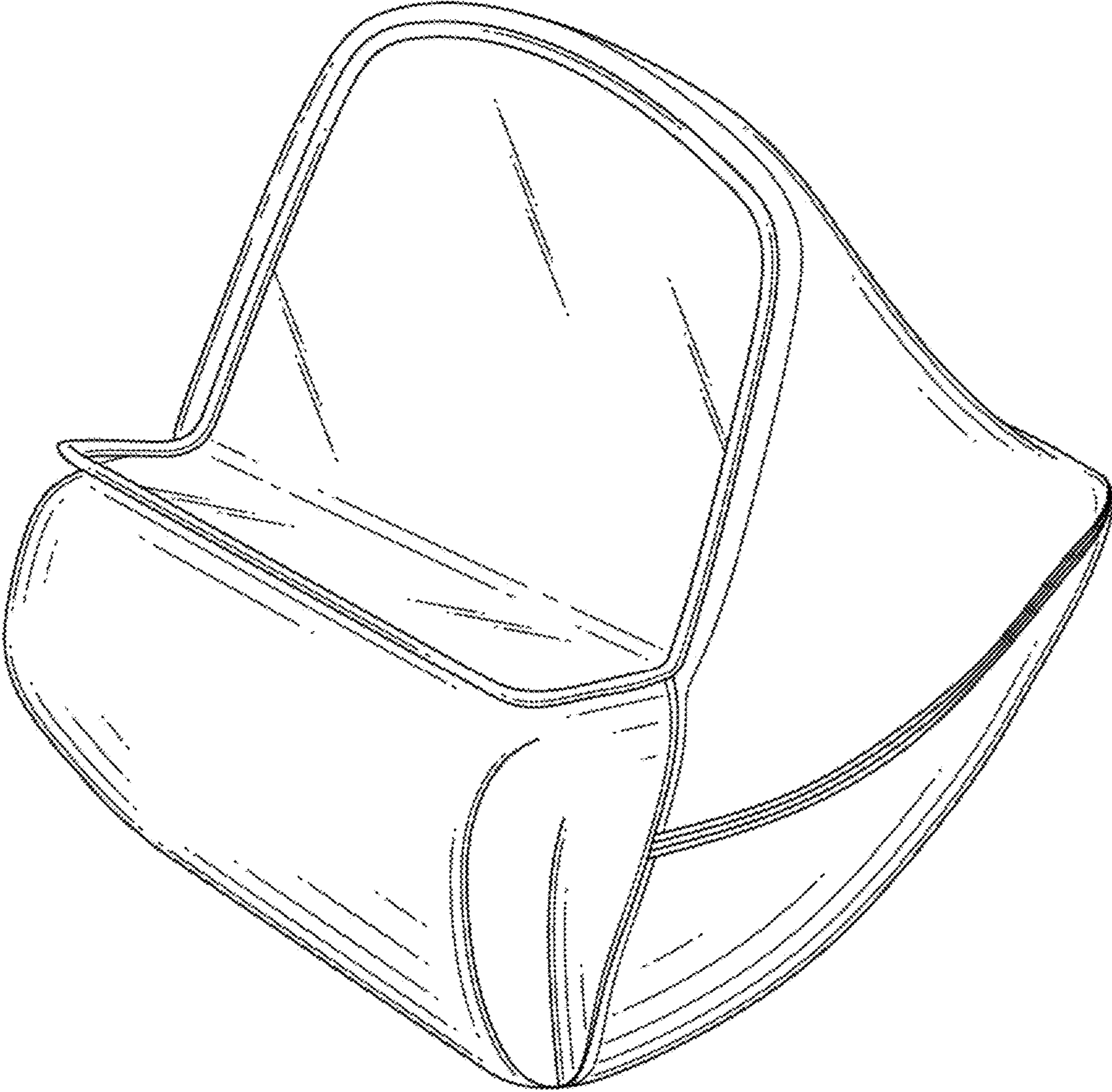

FIG. 1

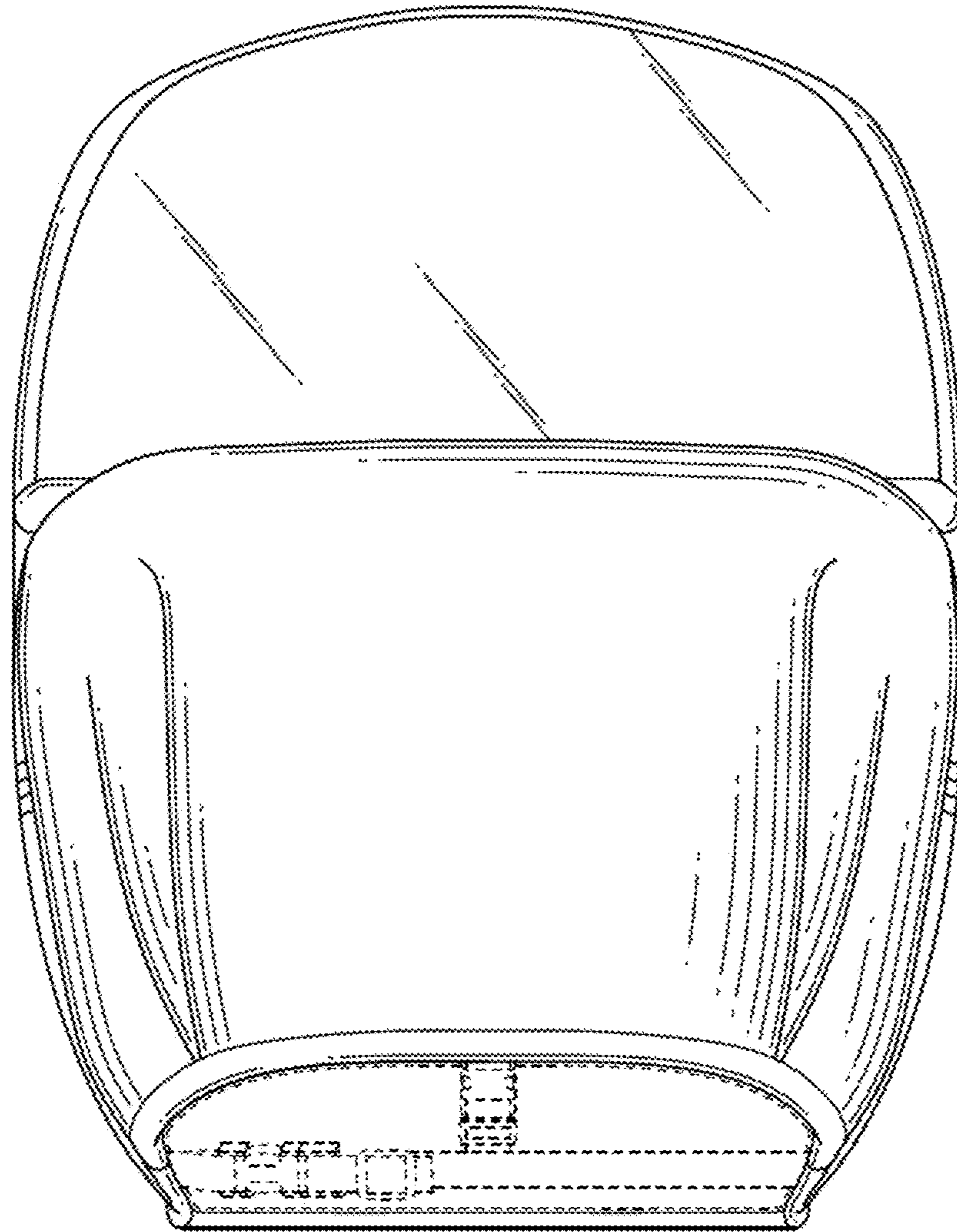

FIG. 2

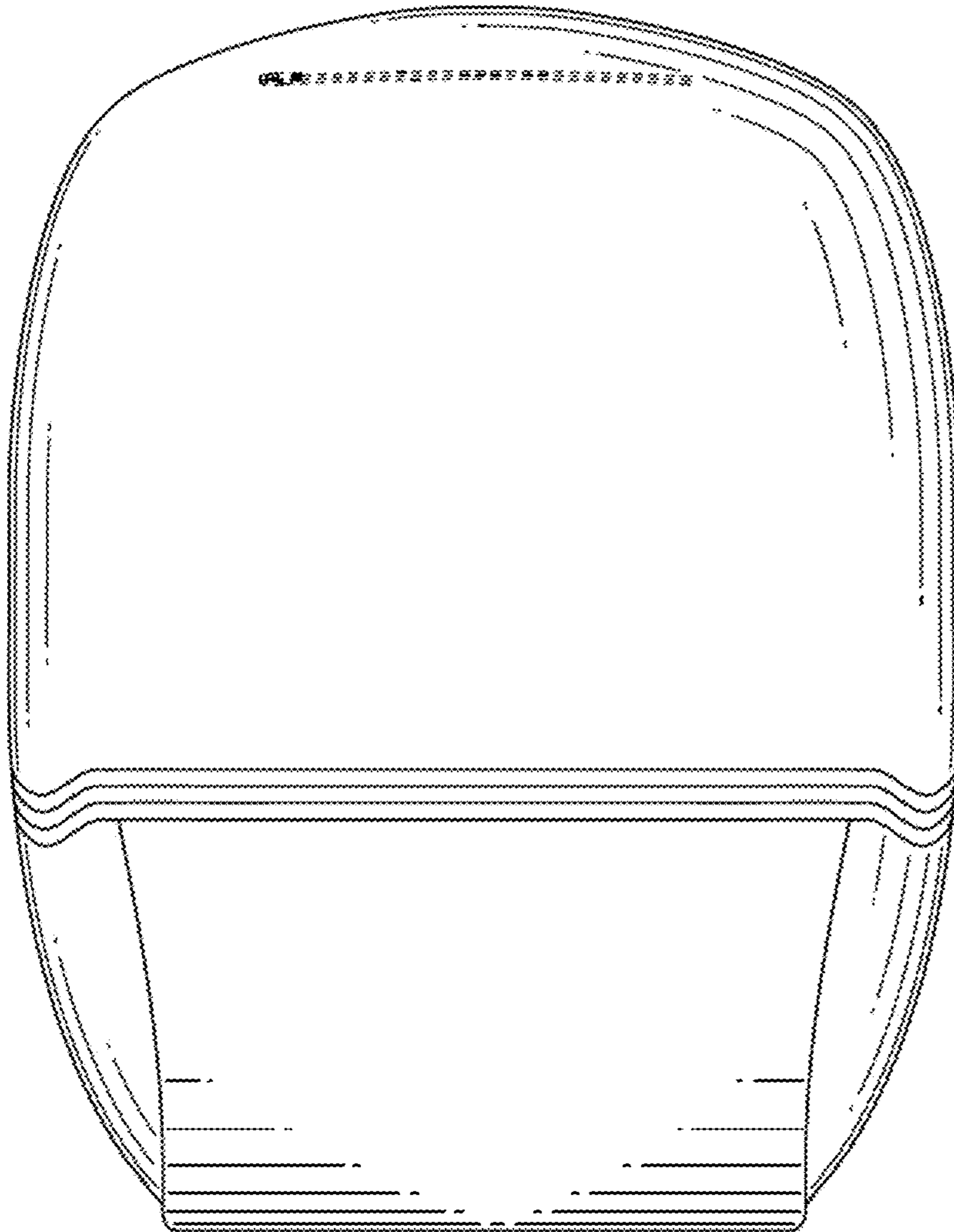

FIG. 3

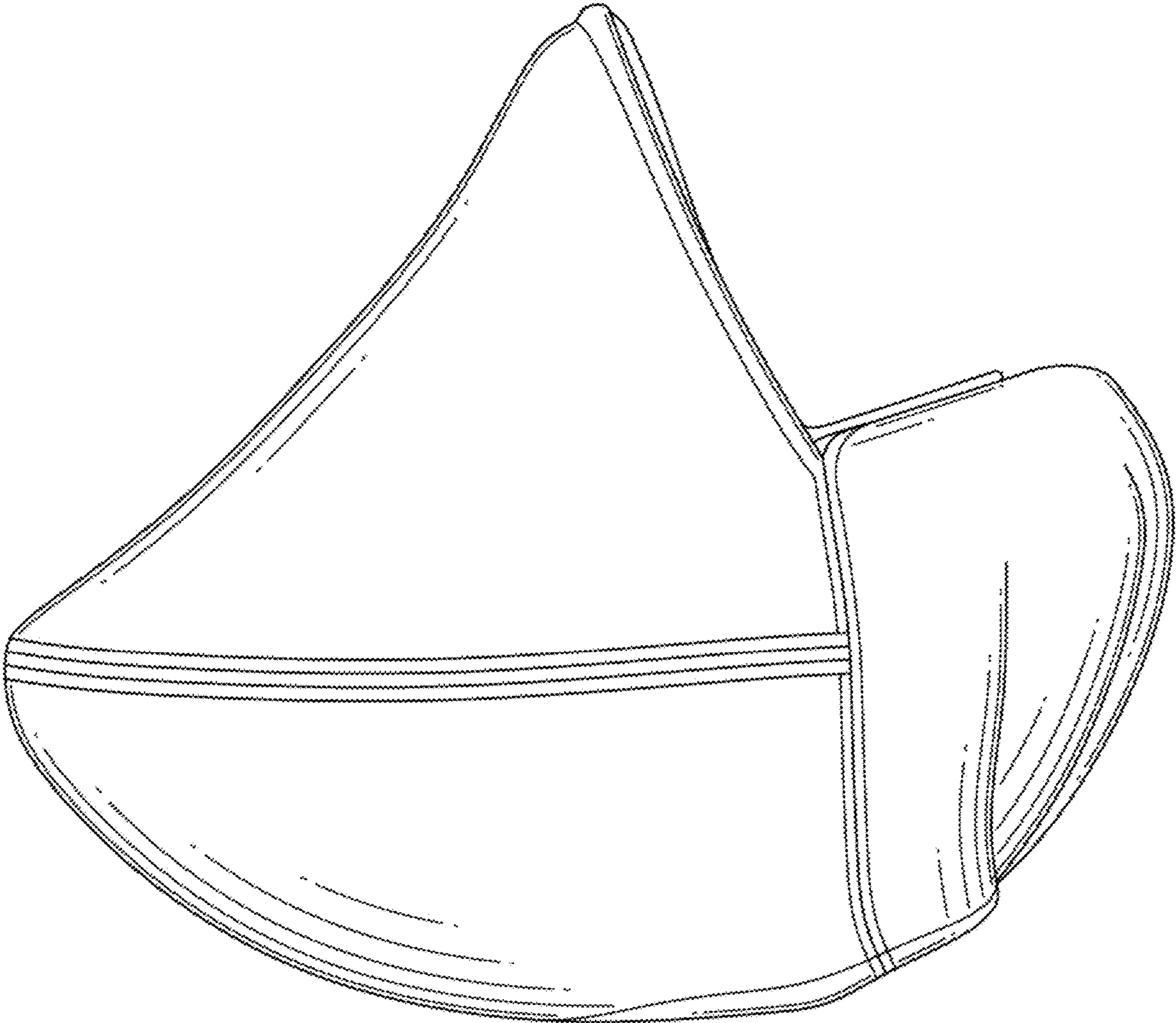

FIG. 4

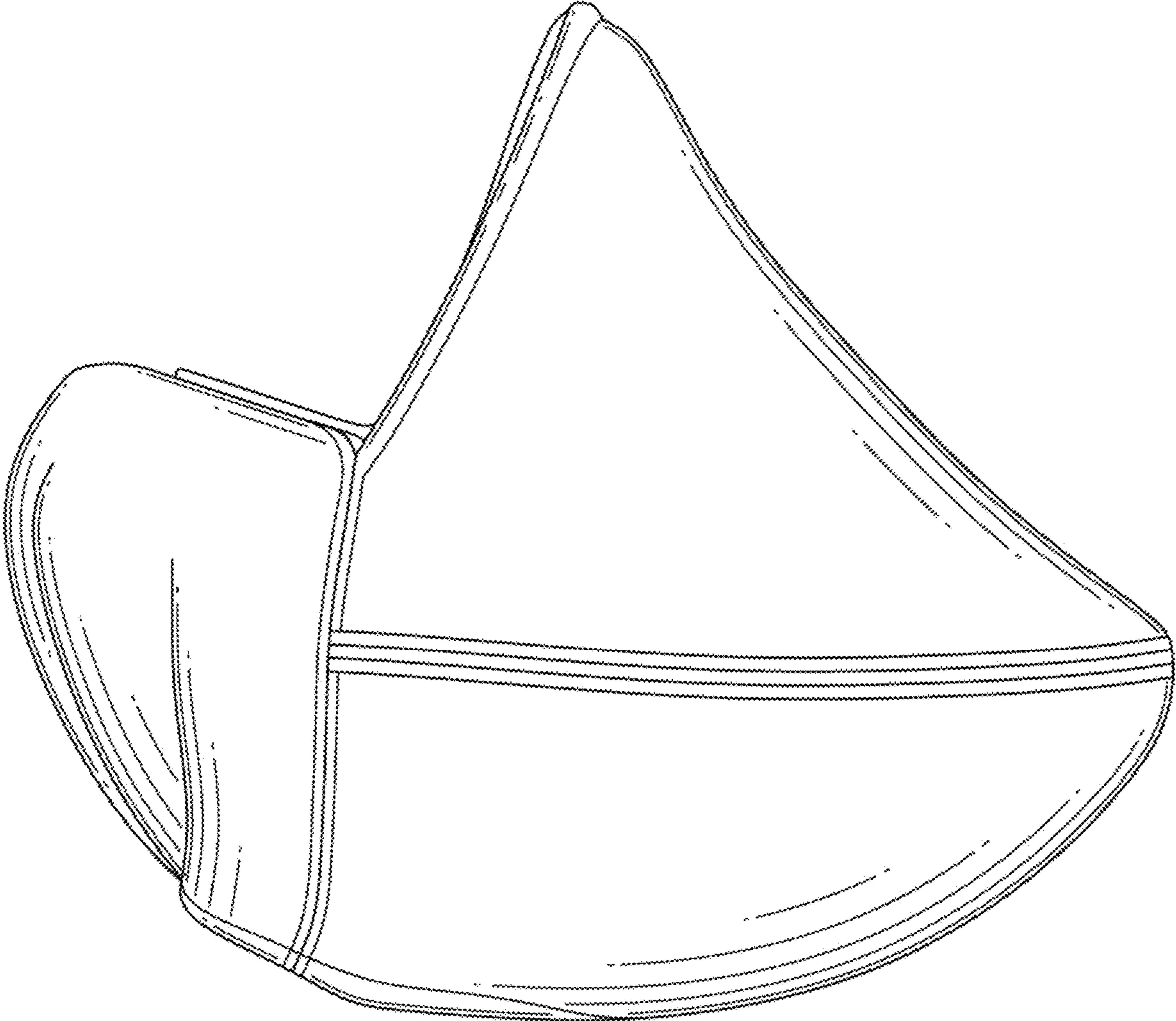

FIG. 5

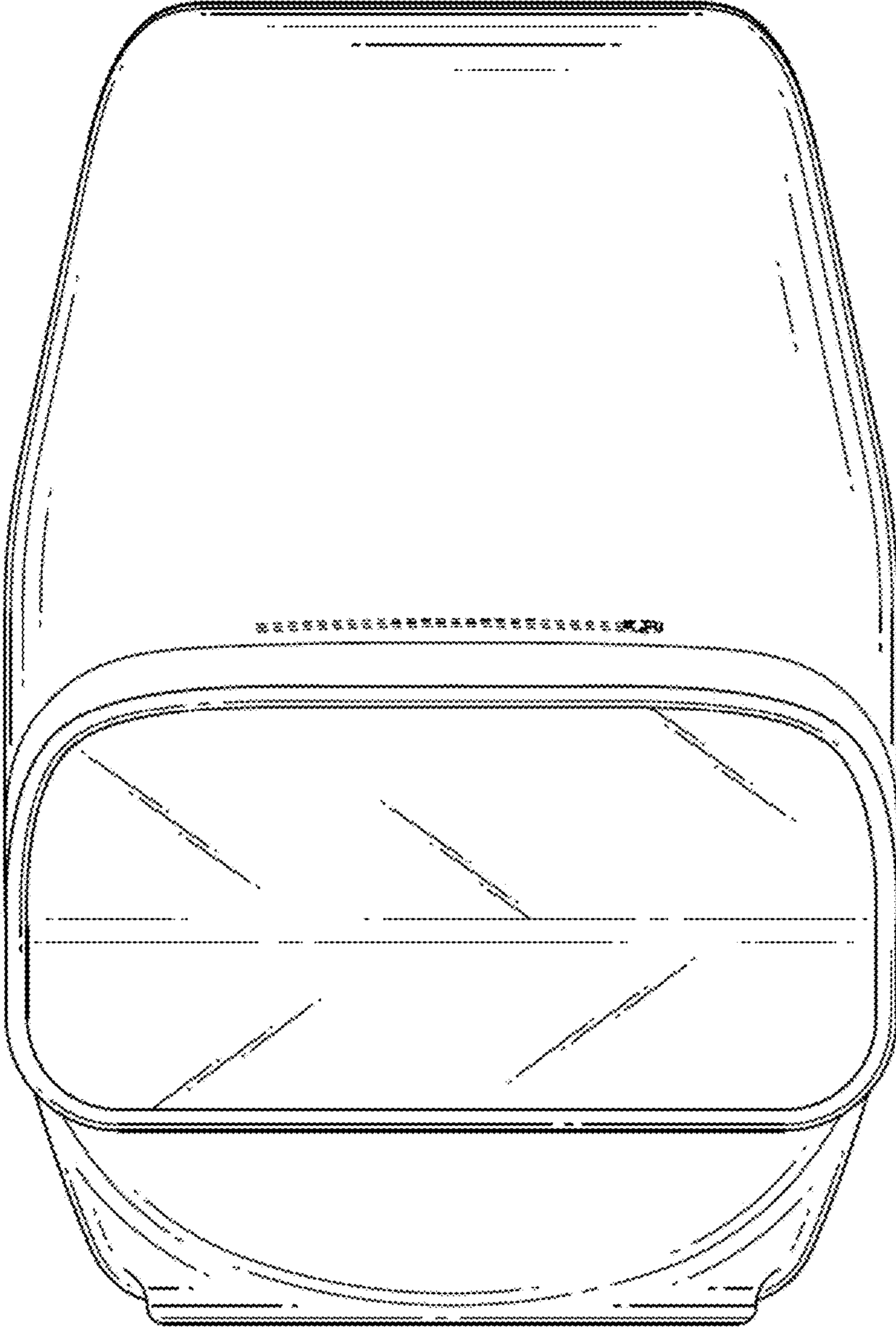

FIG. 6

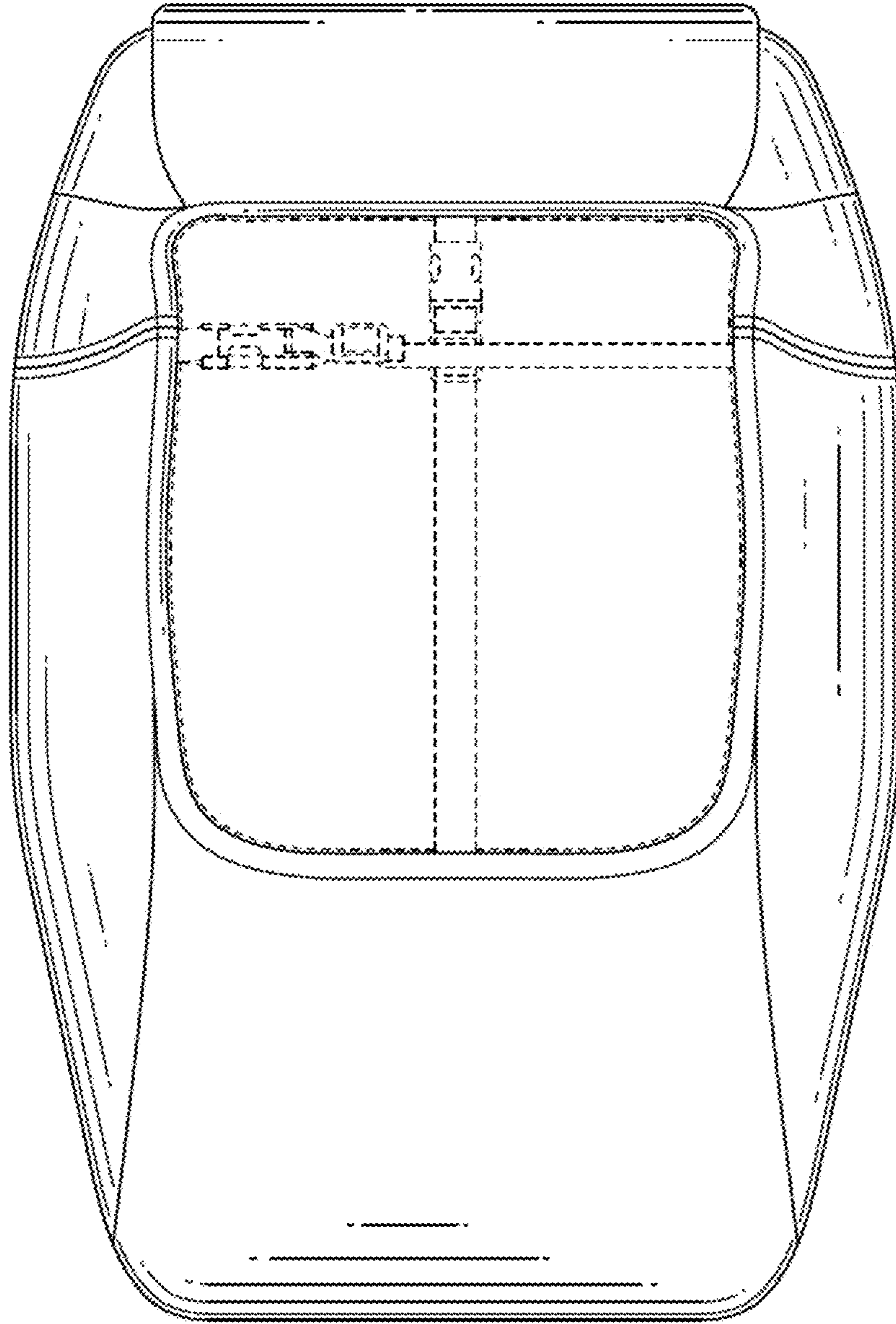

FIG. 7

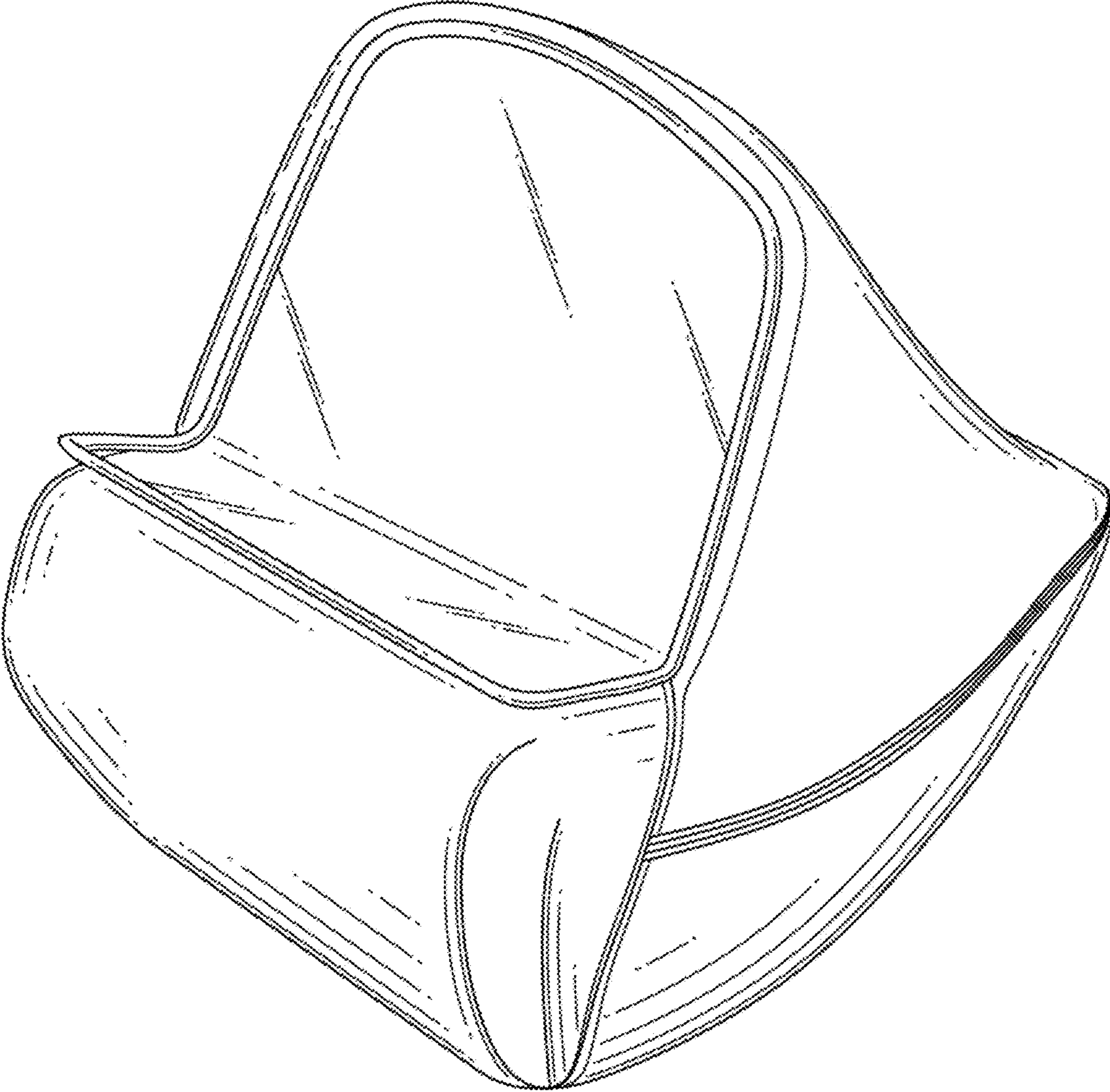

FIG.8

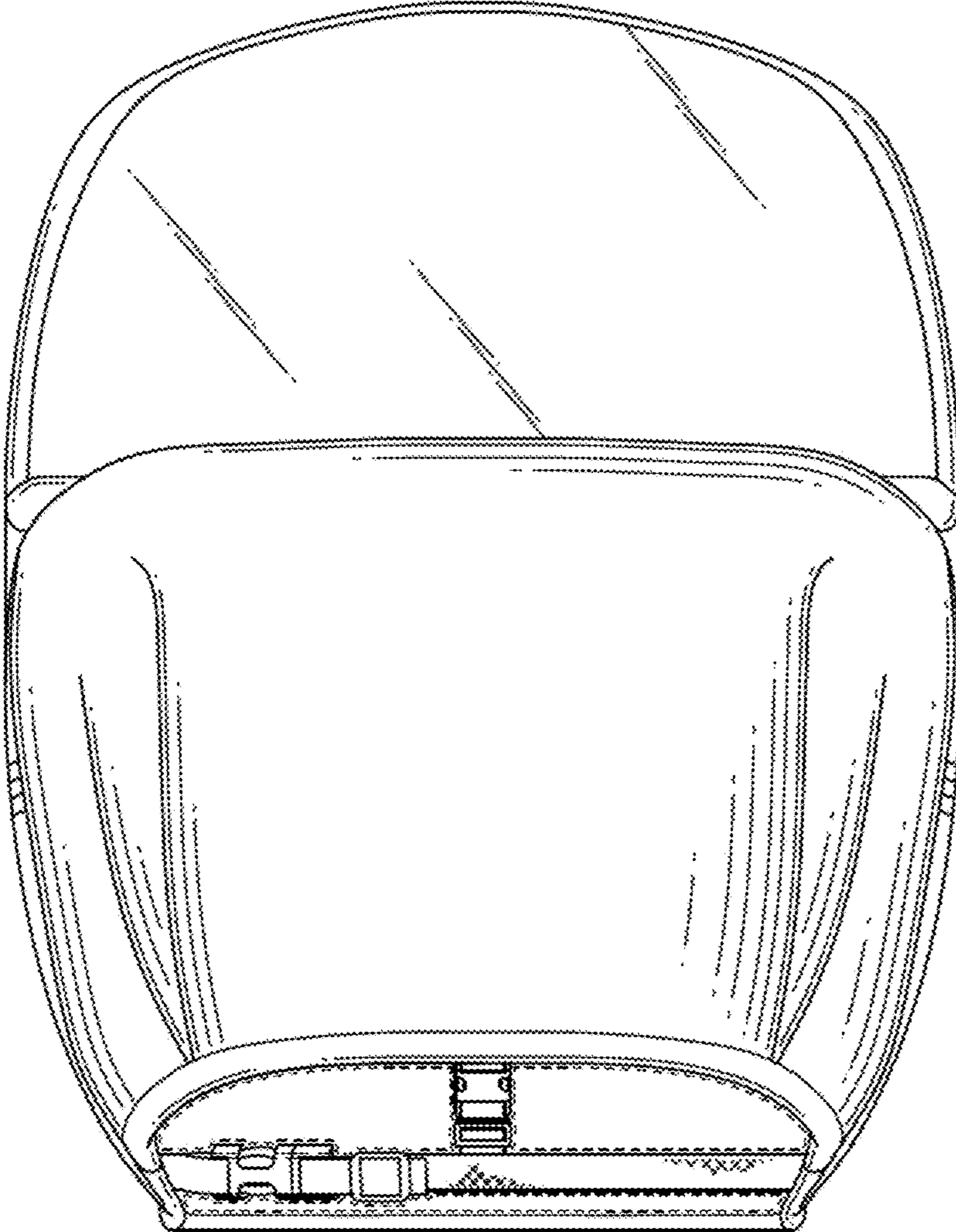

FIG. 9

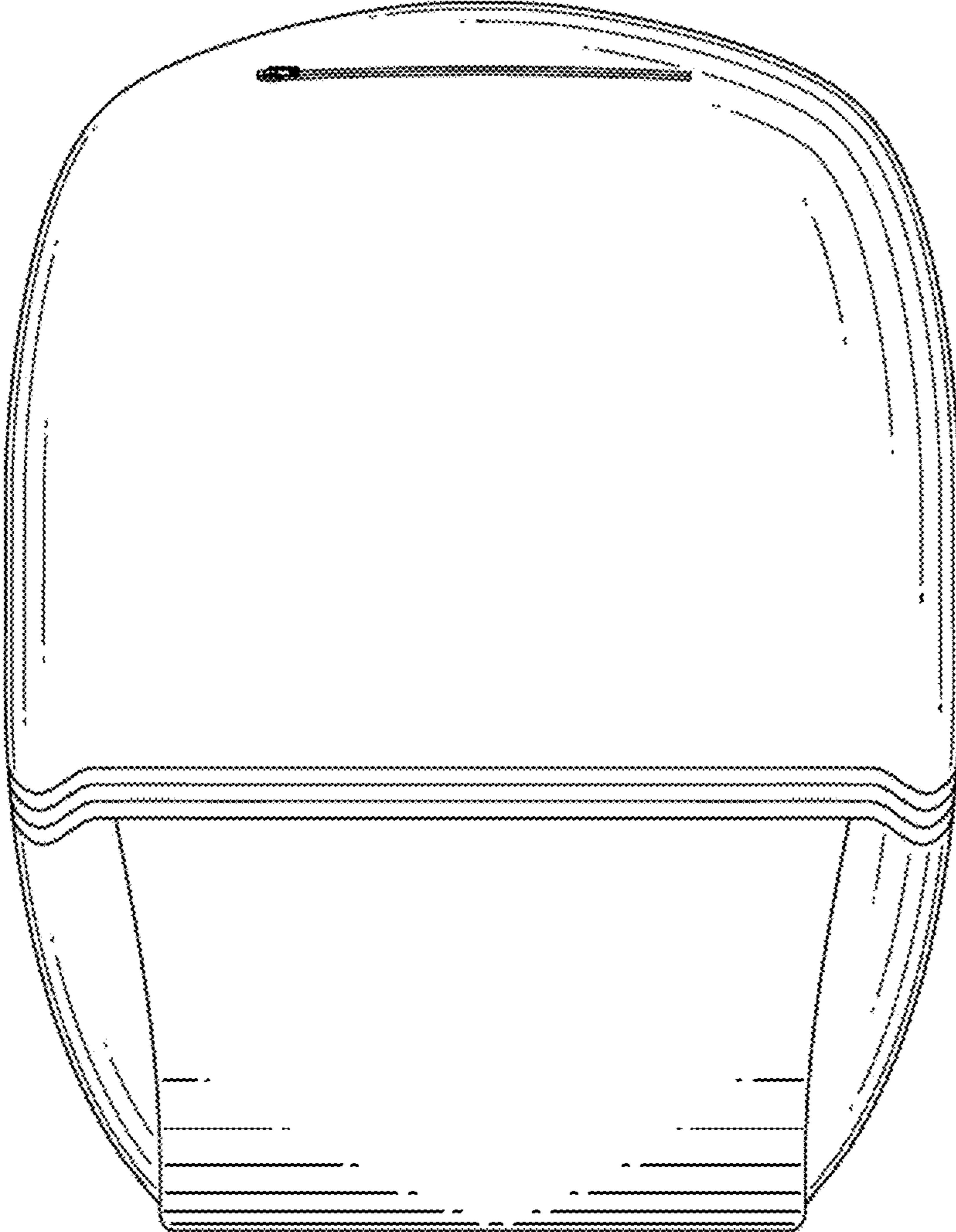

FIG. 10

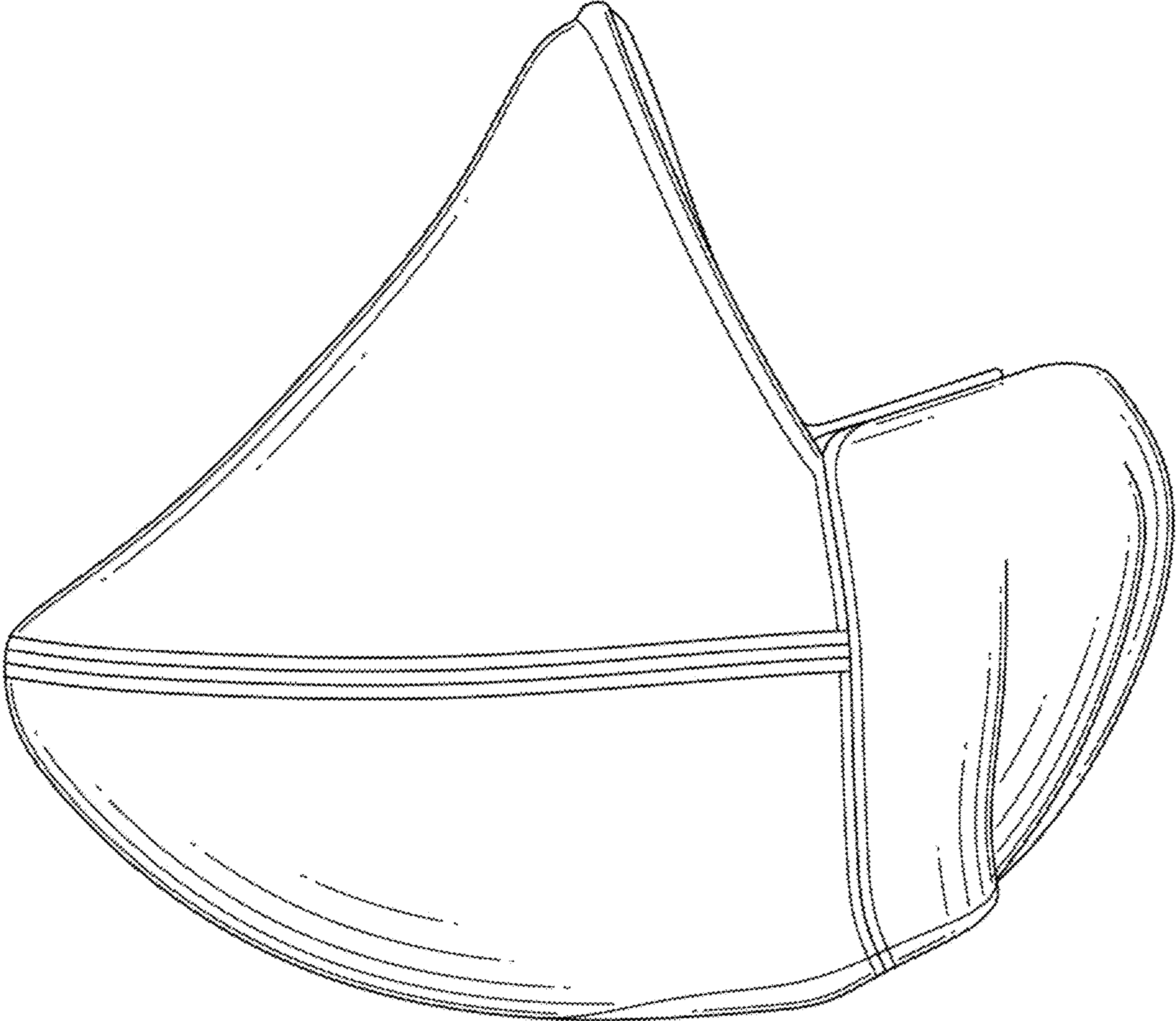

FIG. 11

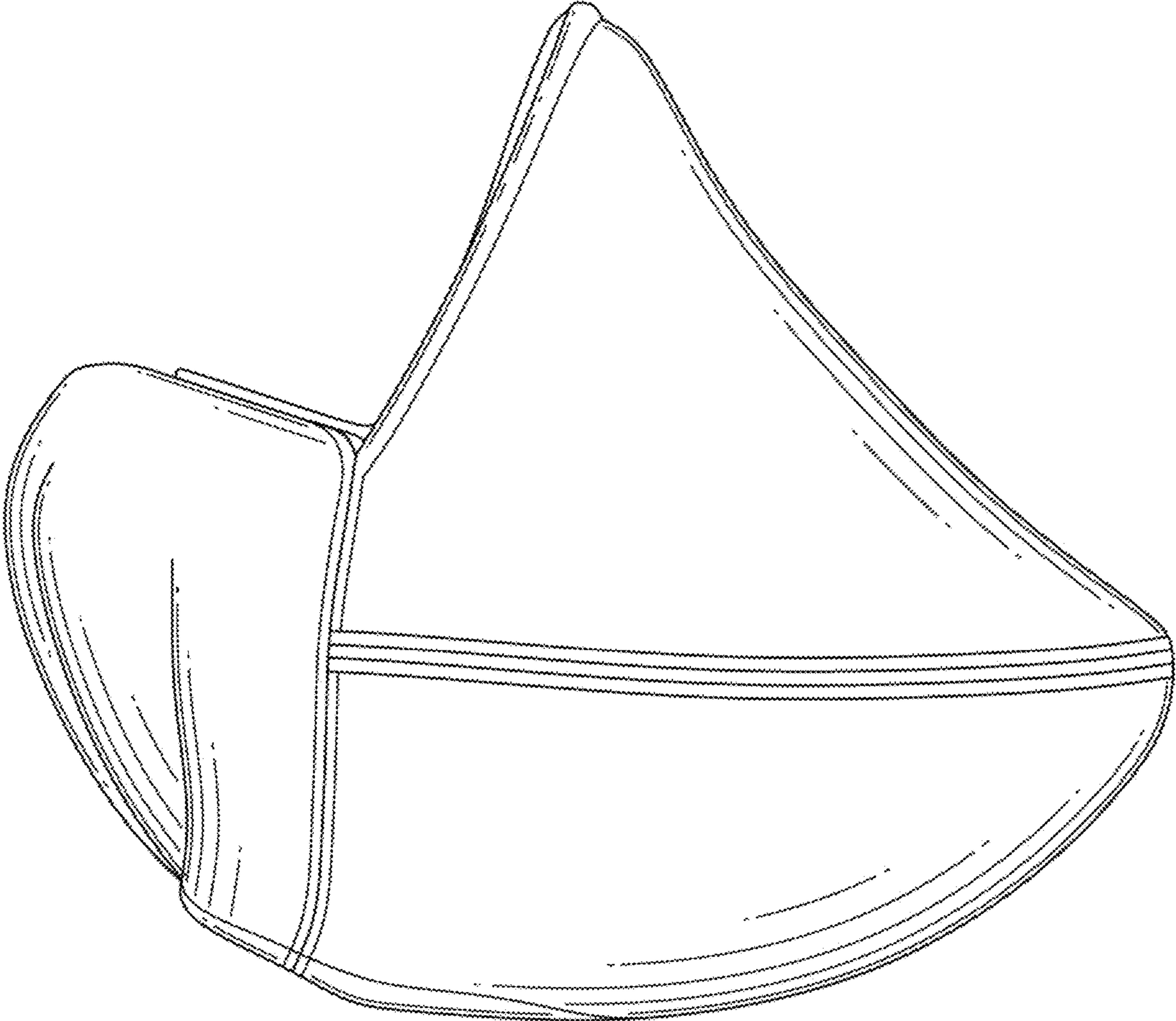

FIG. 12

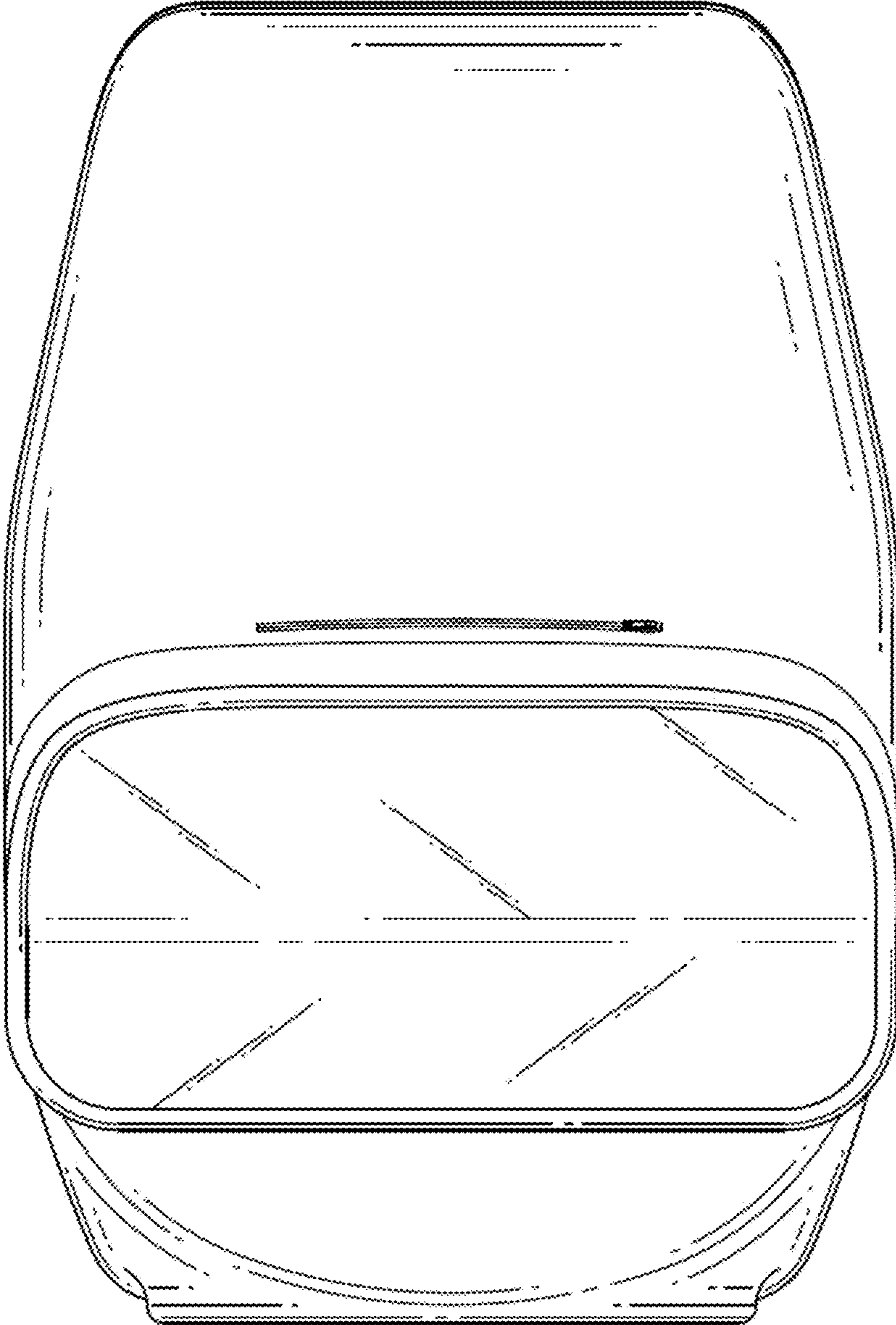

FIG. 13

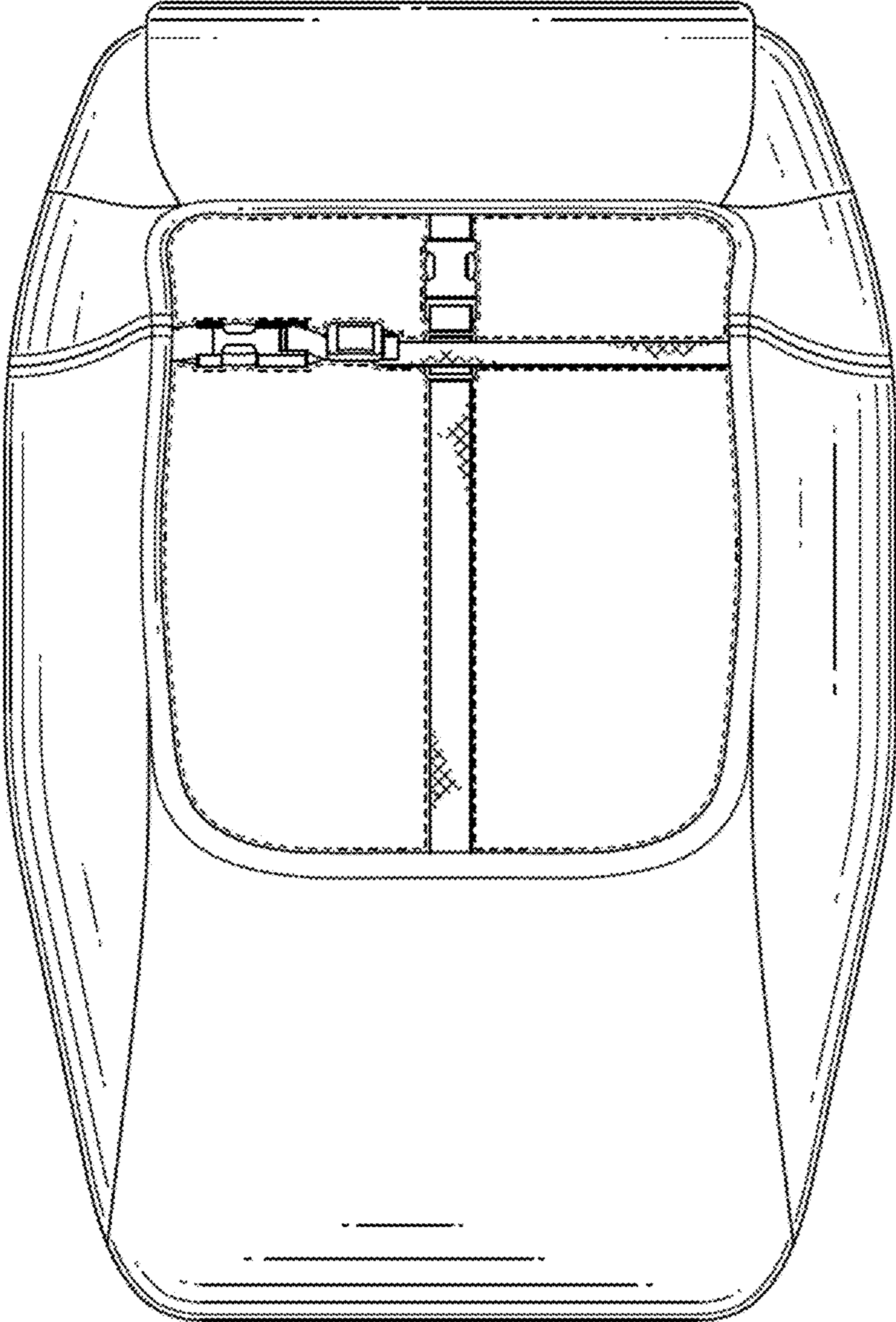

FIG. 14

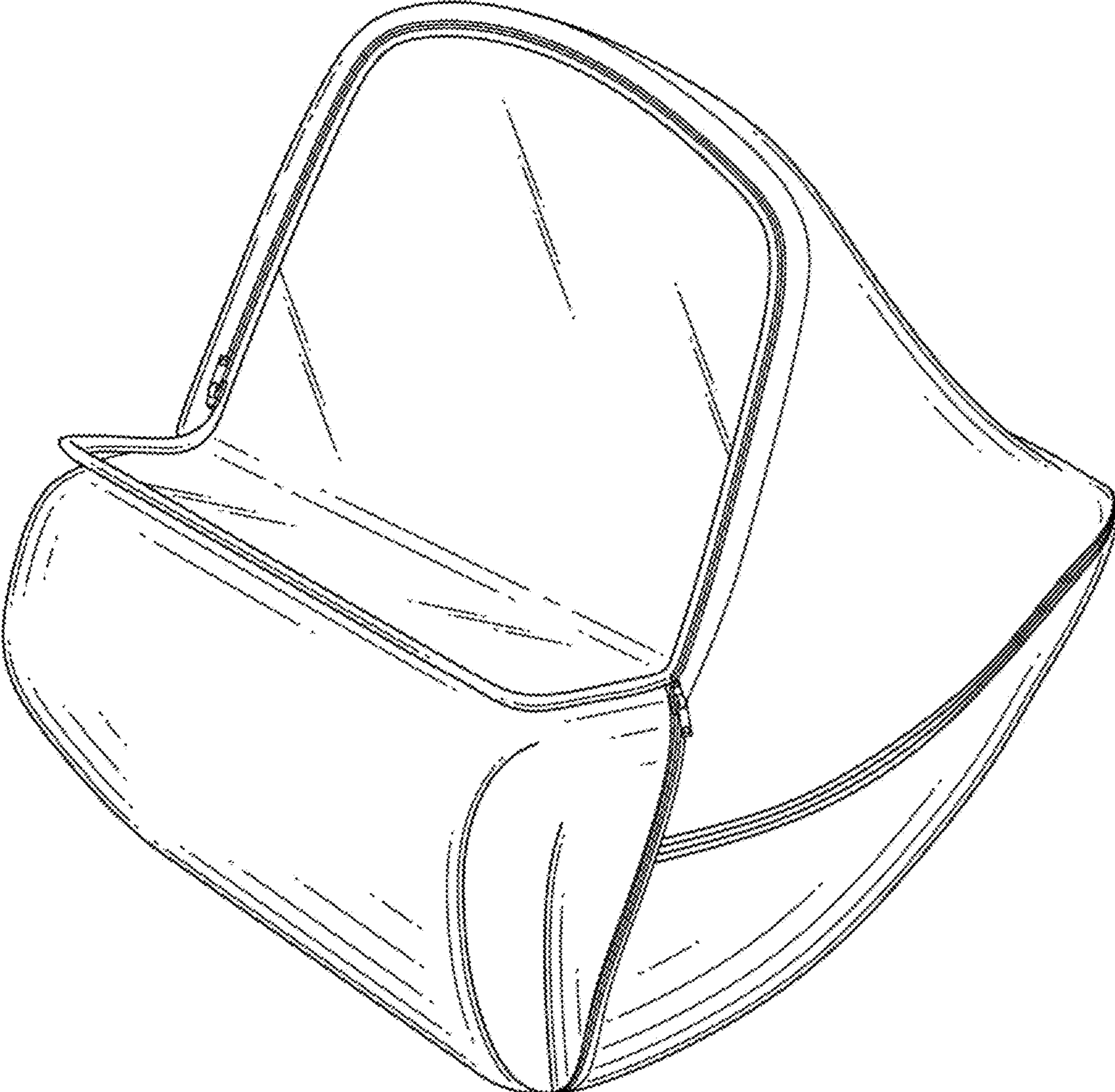

FIG. 15

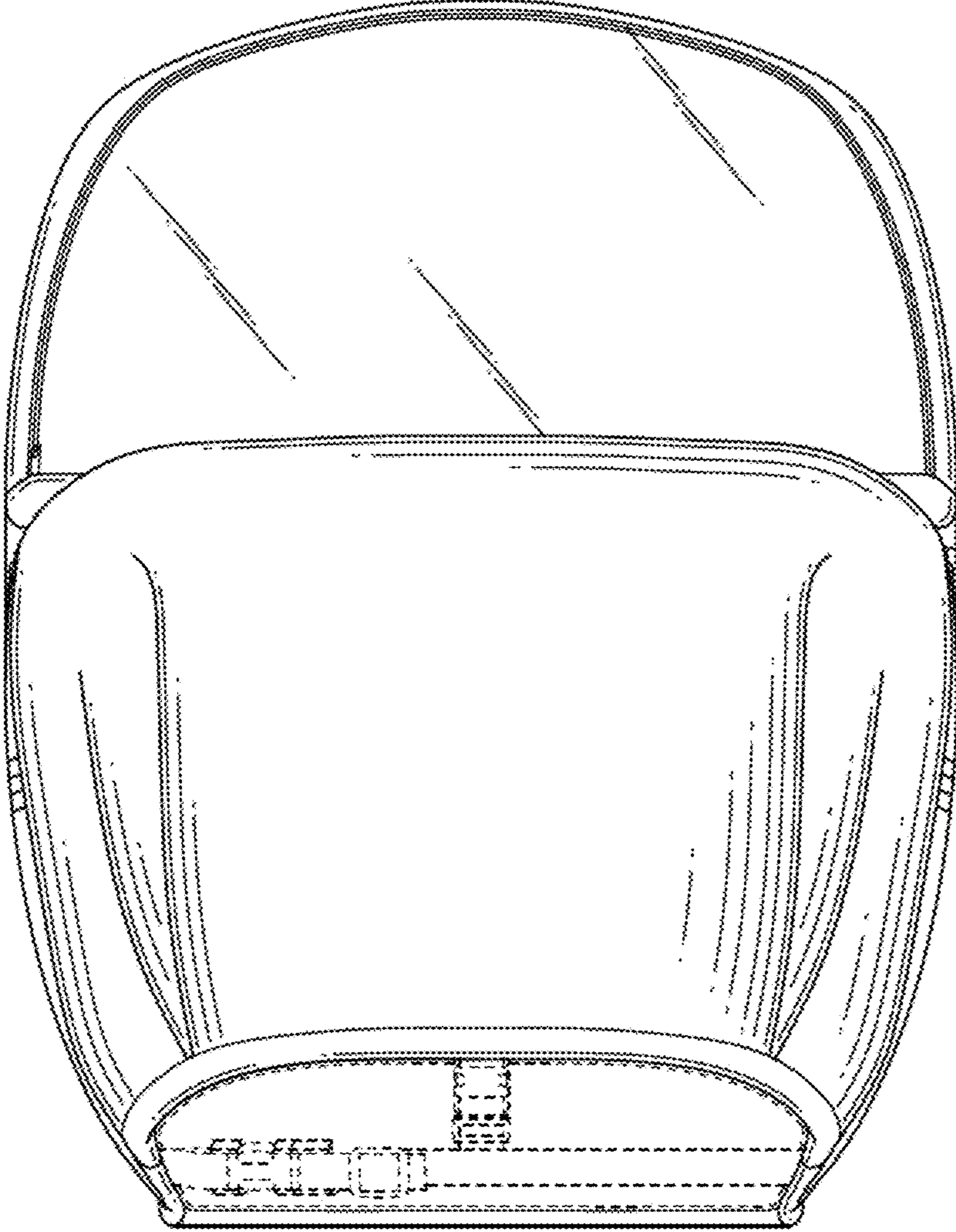

FIG.16

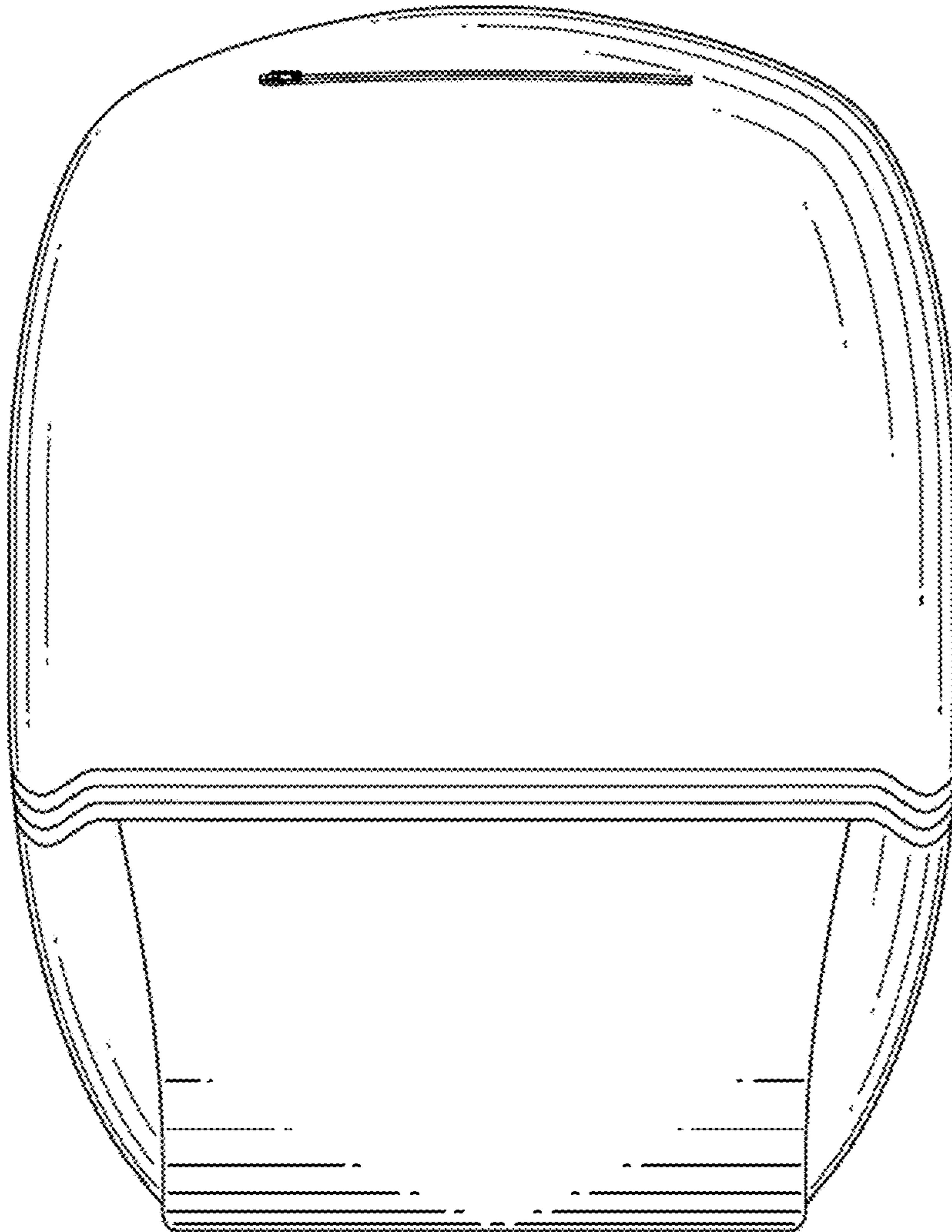

FIG. 17

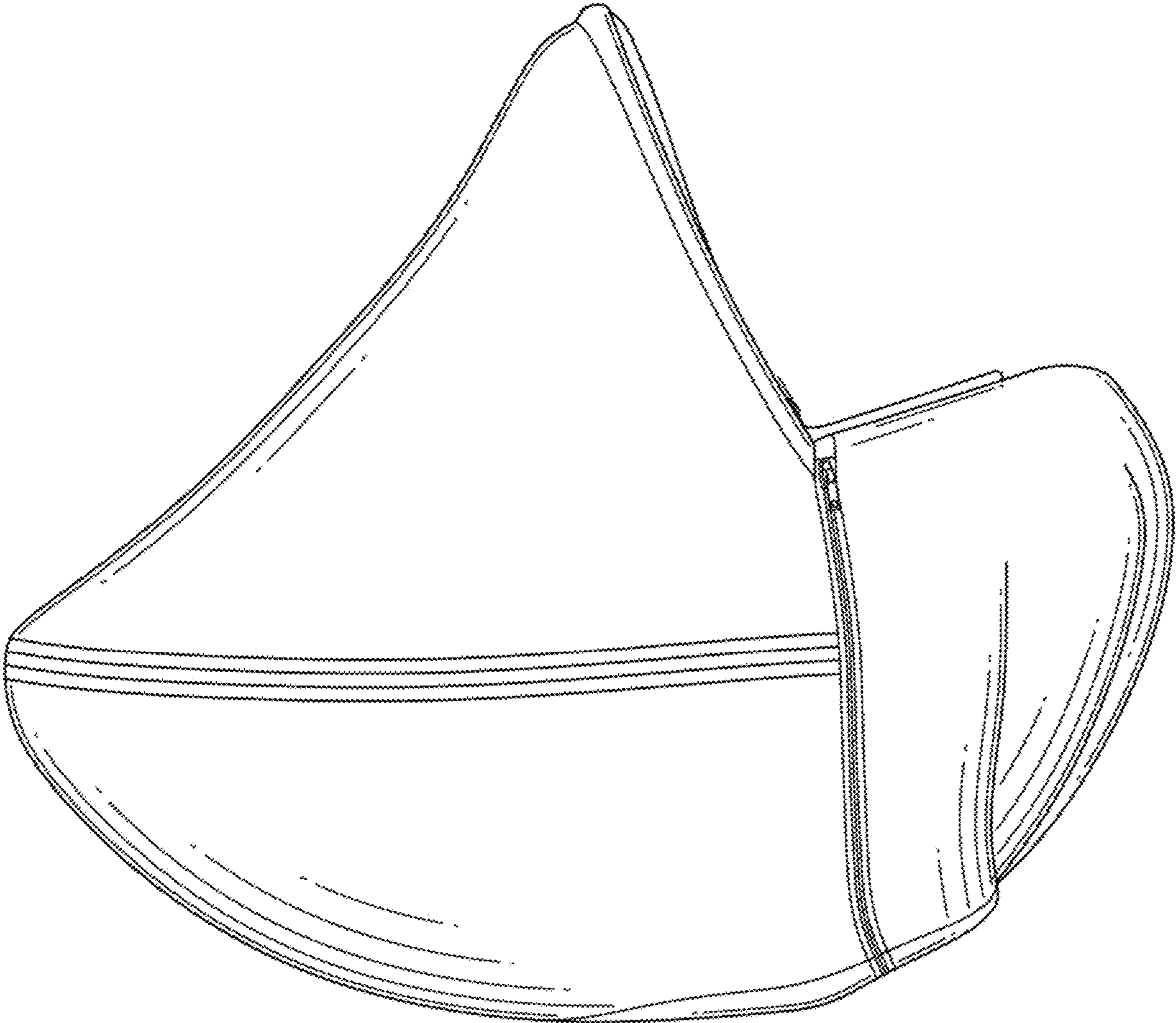

FIG. 18

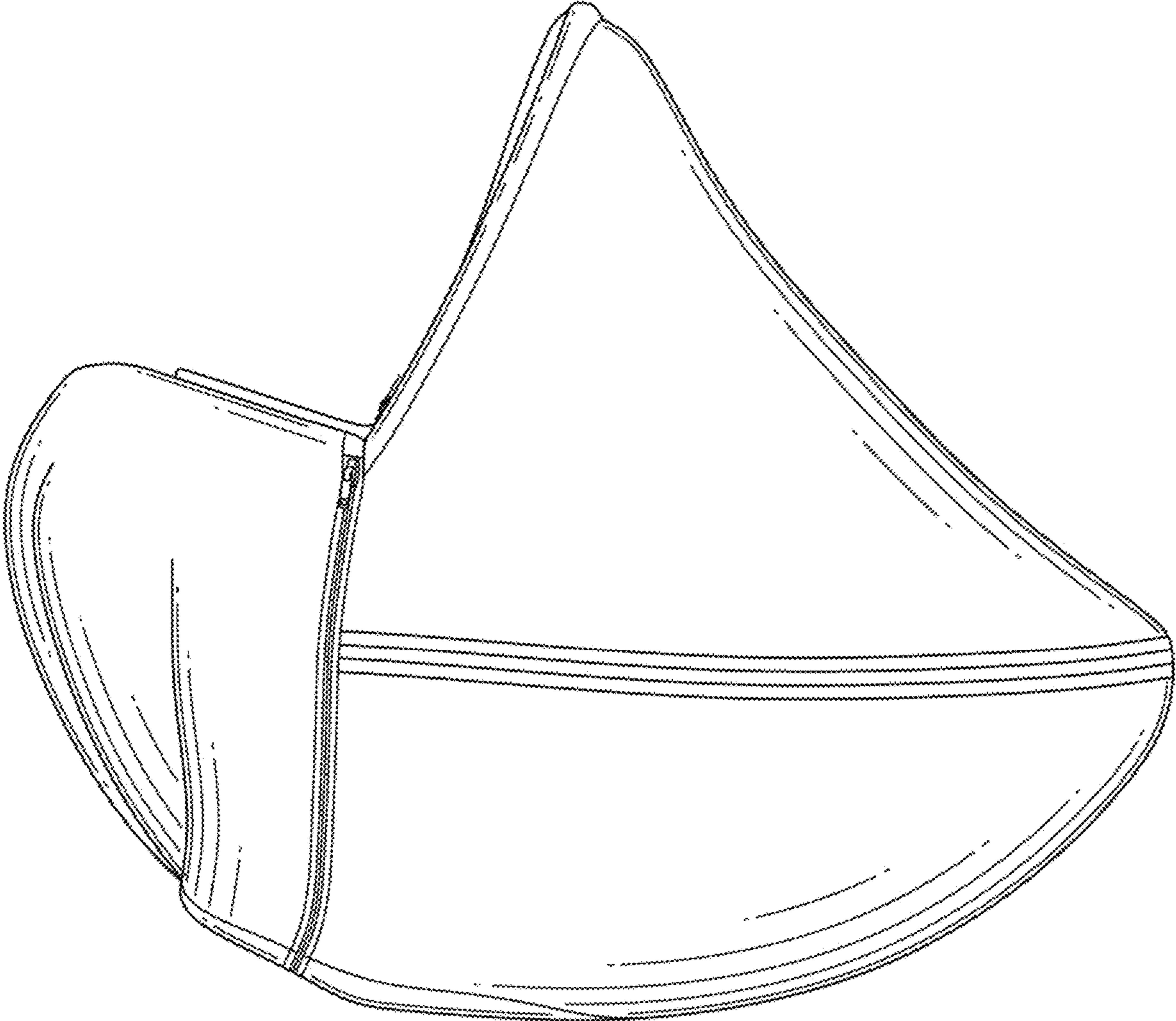

FIG. 19

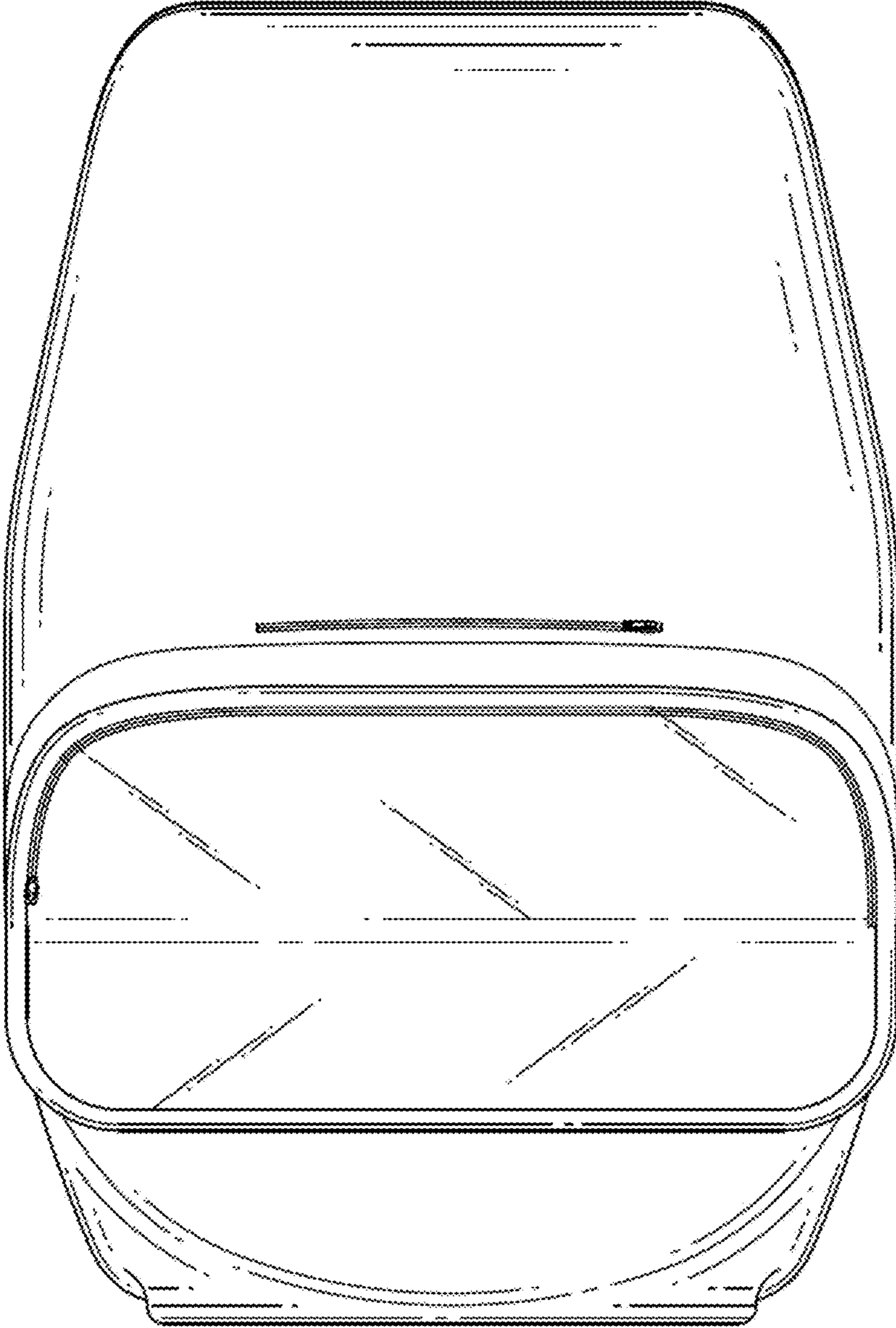

FIG. 20

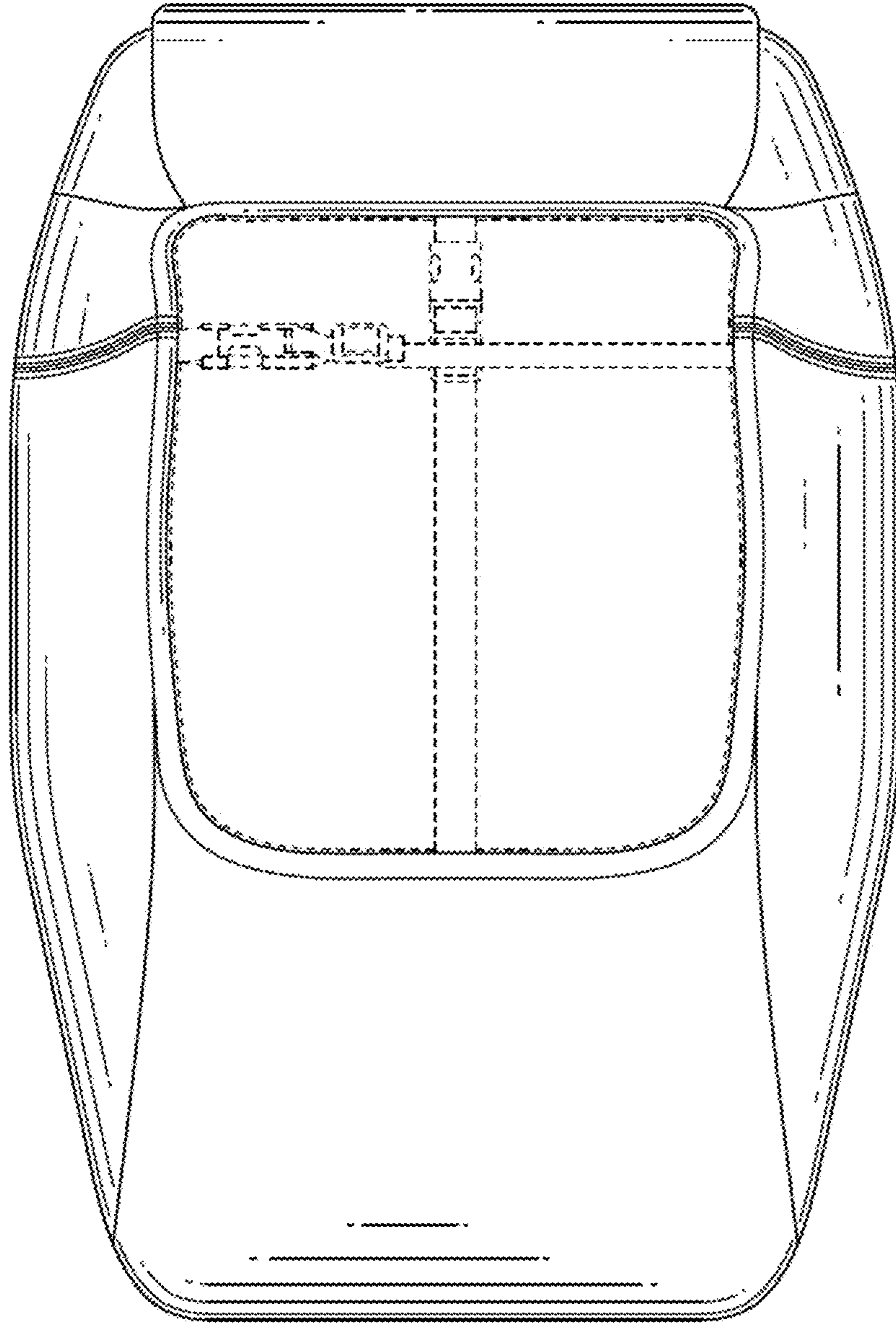

FIG. 21