



US00D897787S

(12) **United States Design Patent** (10) **Patent No.:** **US D897,787 S**
Ferrell (45) **Date of Patent:** **** Oct. 6, 2020**

(54) **UTENSIL**
(71) Applicant: **Lindsey Ferrell**, Lakeland, TN (US)
(72) Inventor: **Lindsey Ferrell**, Lakeland, TN (US)
(**) Term: **15 Years**

D619,414 S * 7/2010 Williams D7/401.2
D631,709 S * 2/2011 Holcomb D7/686
D672,925 S * 12/2012 Hungerford D30/158
D704,518 S * 5/2014 Genatossio D7/688
D705,022 S * 5/2014 Meignan D7/689

(21) Appl. No.: **29/688,558**
(22) Filed: **Apr. 23, 2019**
(51) **LOC (12) Cl.** **07-03**
(52) **U.S. Cl.**
USPC **D7/644**; D7/401.2; D7/653
(58) **Field of Classification Search**
USPC D7/368, 393, 401.2, 642-645, 653-664,
D7/669, 675-677, 683, 686, 688-689,
D7/691; D8/107, 300-301; D10/46.2;
D21/532; D22/117-118; D30/158
CPC ... A01D 9/02; A01D 9/04; A01D 9/06; A47G
21/00; A47G 21/004; A47G 21/005;
A47G 21/02; A47G 21/023; A47G 21/04;
A47G 21/06; A47G 21/08; A47J 43/28;
A47J 43/281; A47J 43/282; A61F 13/10;
A61J 7/0023; B25G 1/00; B25G 1/01;
B25G 1/02; B25G 3/00; B65D 75/56;
B65D 75/563; B65D 75/566; B67B 7/00;
B67B 7/724; B67B 7/73
See application file for complete search history.

FOREIGN PATENT DOCUMENTS

CN 304792499 S 8/2018

* cited by examiner

Primary Examiner — Ricky Pham

(74) *Attorney, Agent, or Firm* — Baker Donelson

(57) **CLAIM**

The ornamental design for a utensil, as shown and described.

DESCRIPTION

FIG. 1 is a perspective view of a utensil showing the new design;

FIG. 2 is a front view thereof;

FIG. 3 is a rear view thereof;

FIG. 4 is a left side view thereof;

FIG. 5 is a right side view thereof;

FIG. 6 is a top view thereof; and

FIG. 7 is a bottom view thereof.

FIG. 8 is a perspective view of a utensil showing an alternative embodiment of the new design;

FIG. 9 is a front view of FIG. 8;

FIG. 10 is a rear view of FIG. 8;

FIG. 11 is a left side view of FIG. 8;

FIG. 12 is a right side view of FIG. 8;

FIG. 13 is a top view of FIG. 8; and,

FIG. 14 is a bottom view of FIG. 8.

The broken lines shown in the drawings are for illustrative purposes only and form no part of the claimed design.

(56) **References Cited**

U.S. PATENT DOCUMENTS

D284,342 S * 6/1986 Campbell D10/46.2
D356,349 S * 3/1995 Kino A63H 33/32
D21/532
D405,660 S * 2/1999 Hansen D7/688
D446,091 S * 8/2001 Short D7/688
D496,565 S * 9/2004 Stewart D7/691
D536,583 S * 2/2007 Bodum D7/653

1 Claim, 8 Drawing Sheets

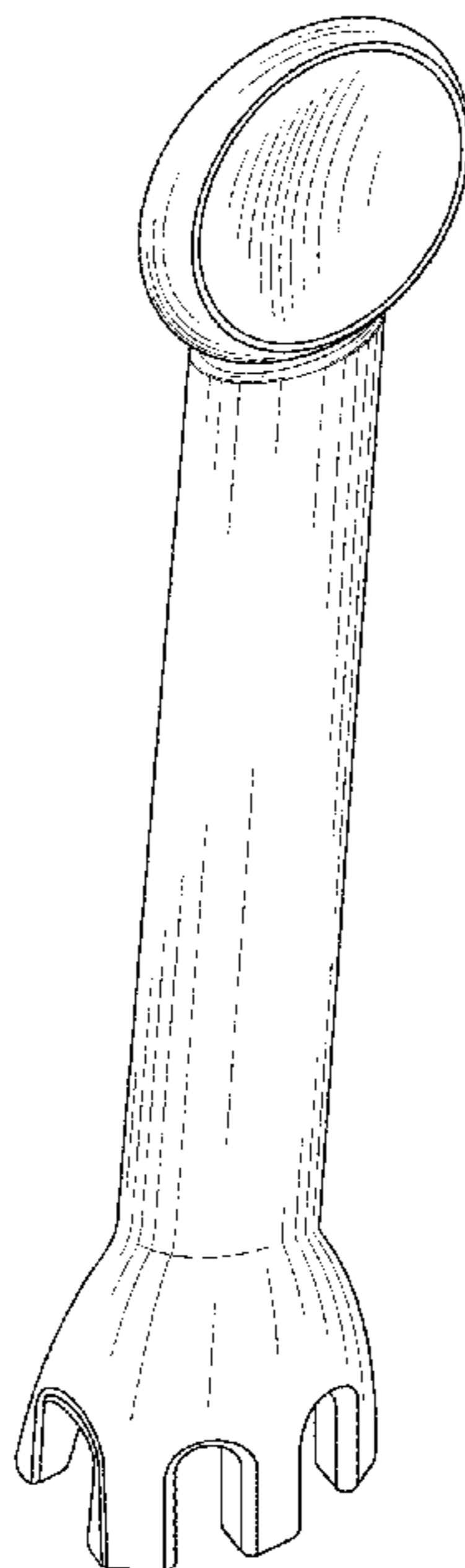

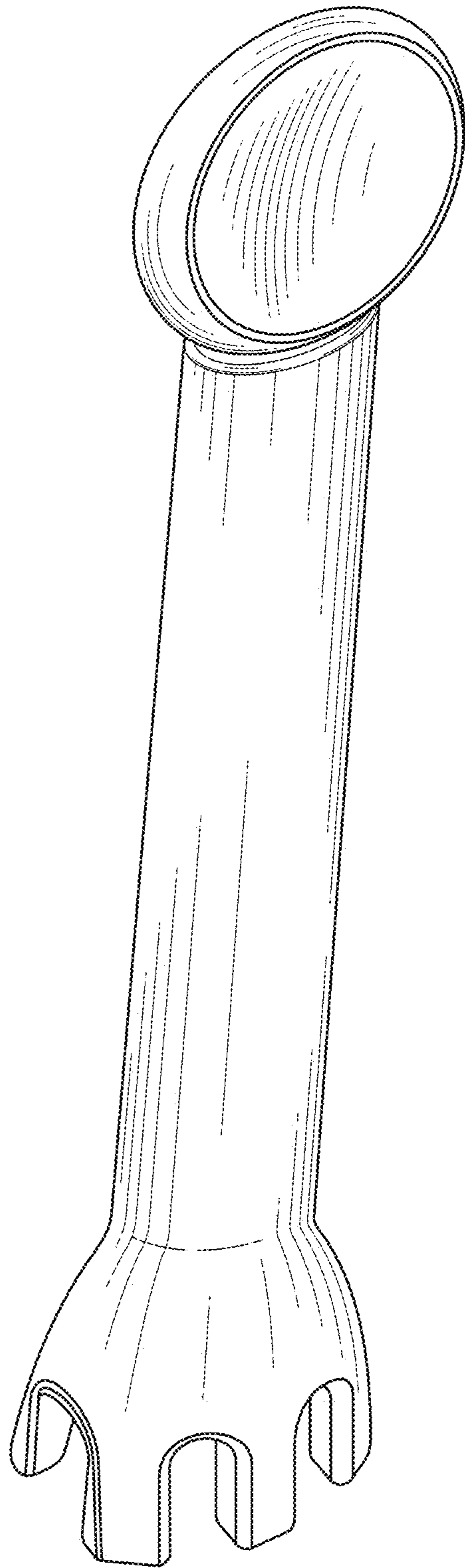

FIG. 1

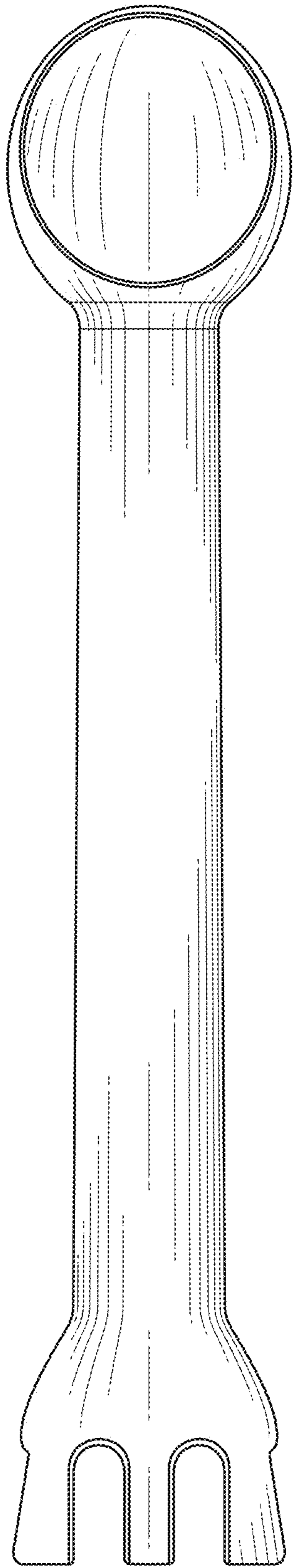

FIG. 2

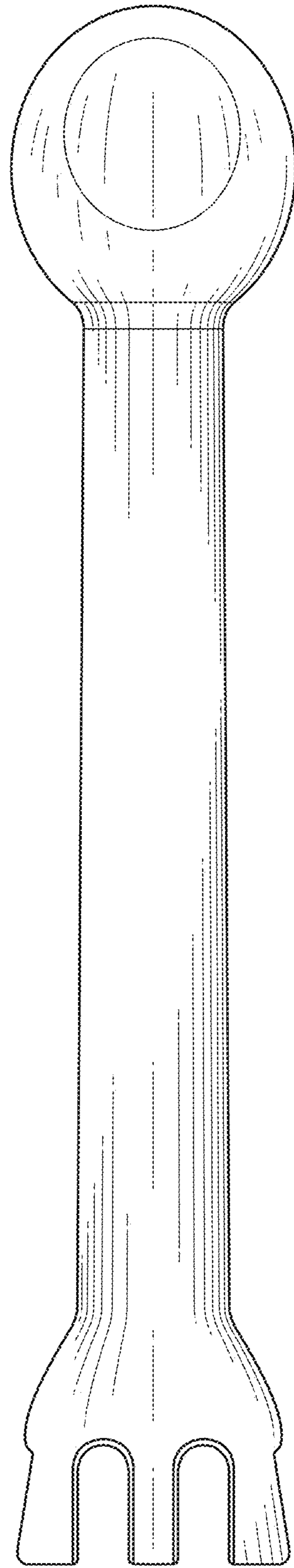

FIG. 3

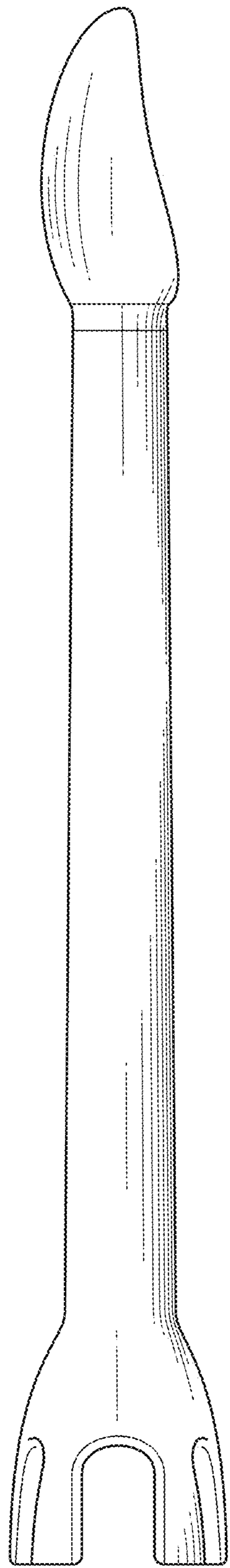

FIG. 4

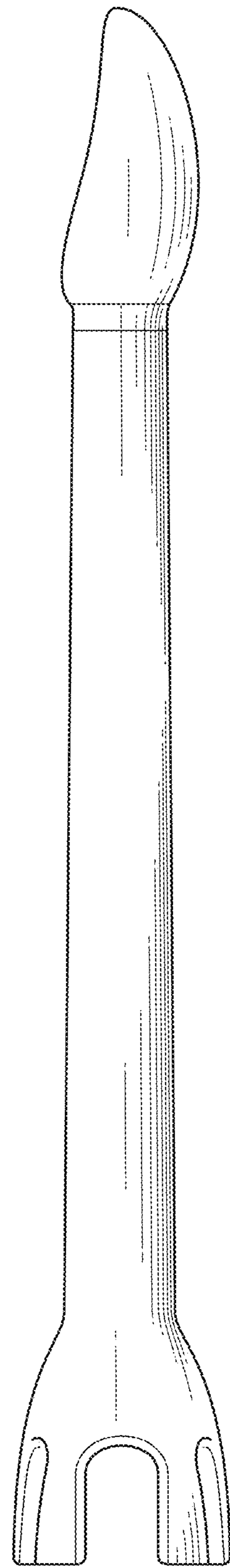

FIG. 5

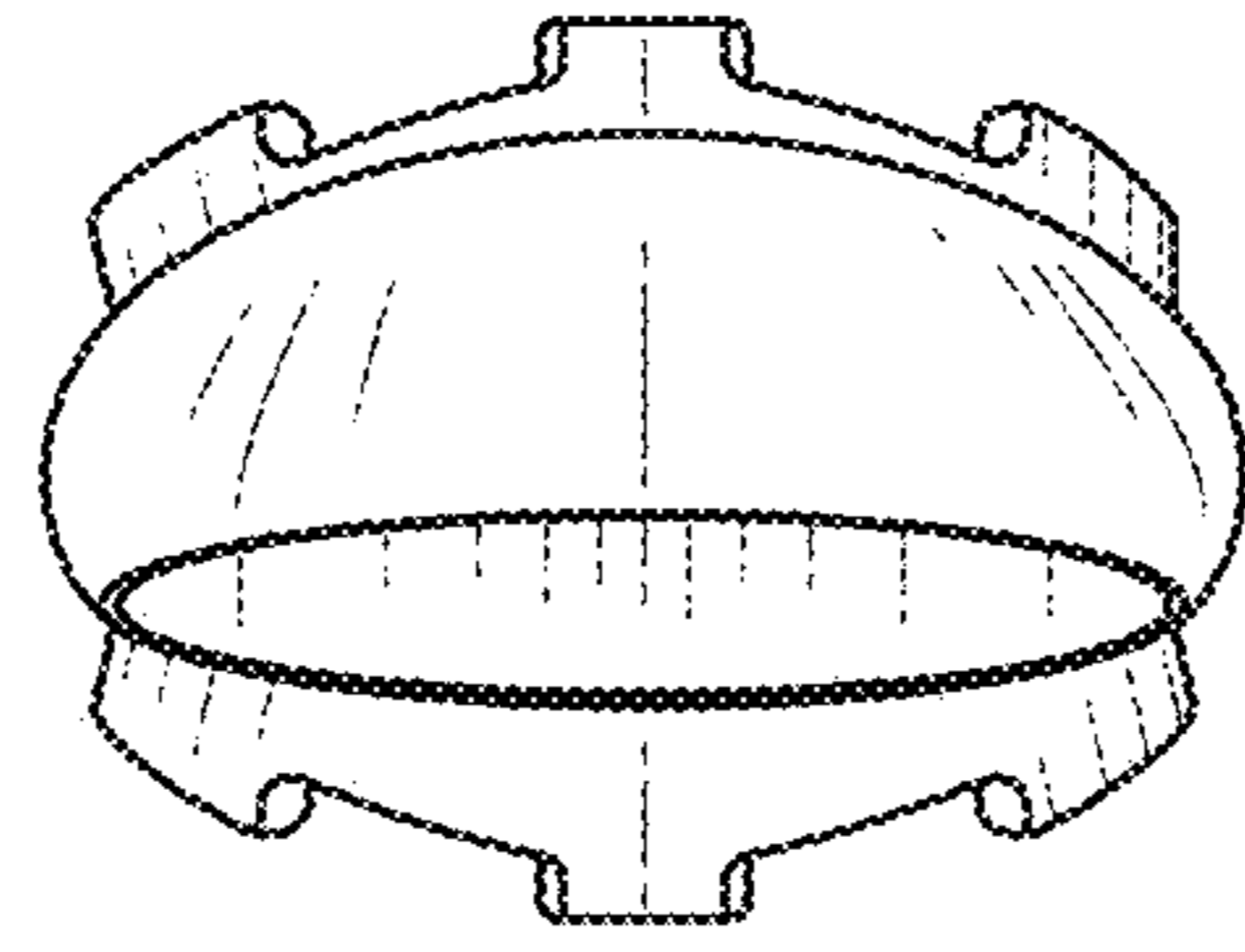

FIG. 6

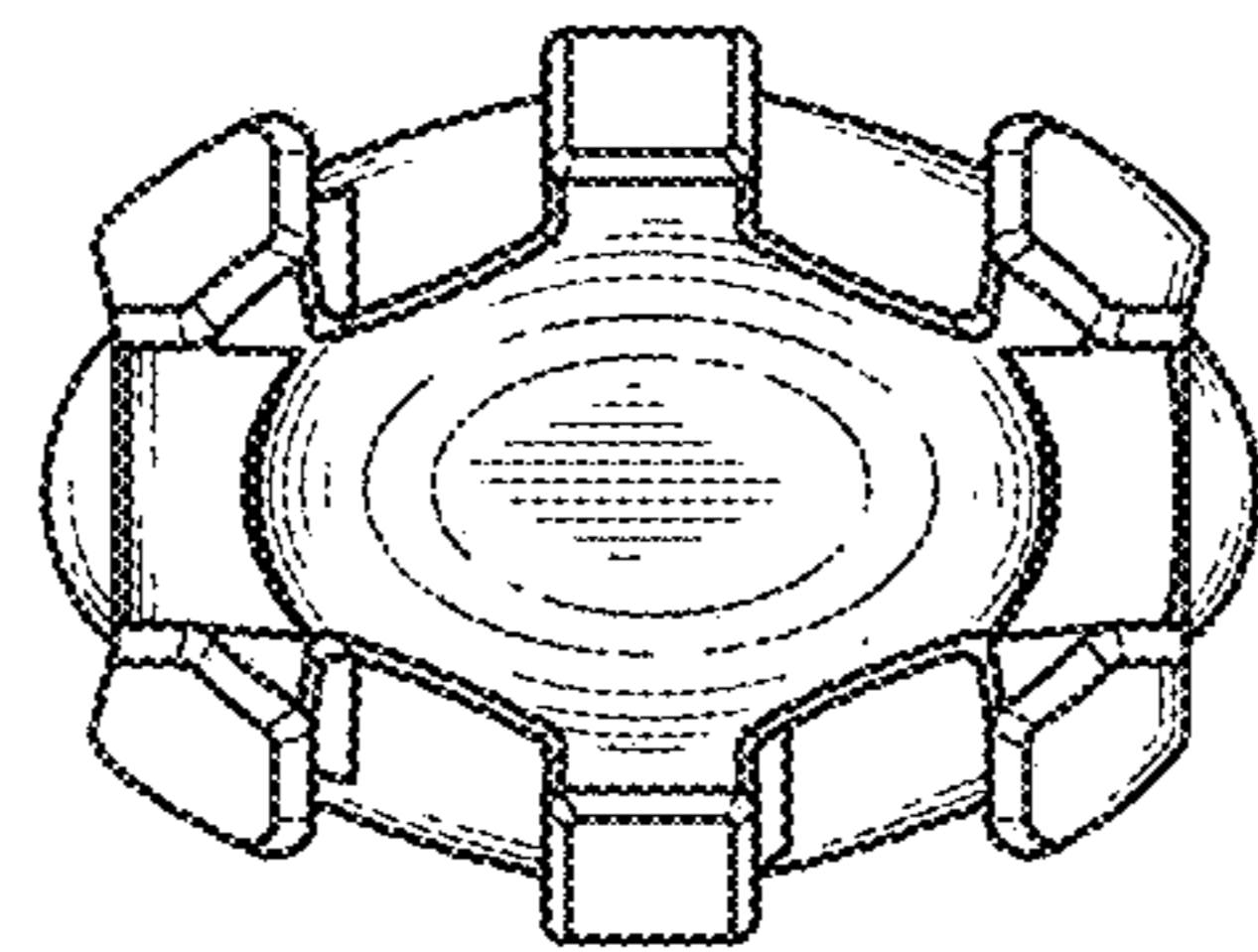

FIG. 7

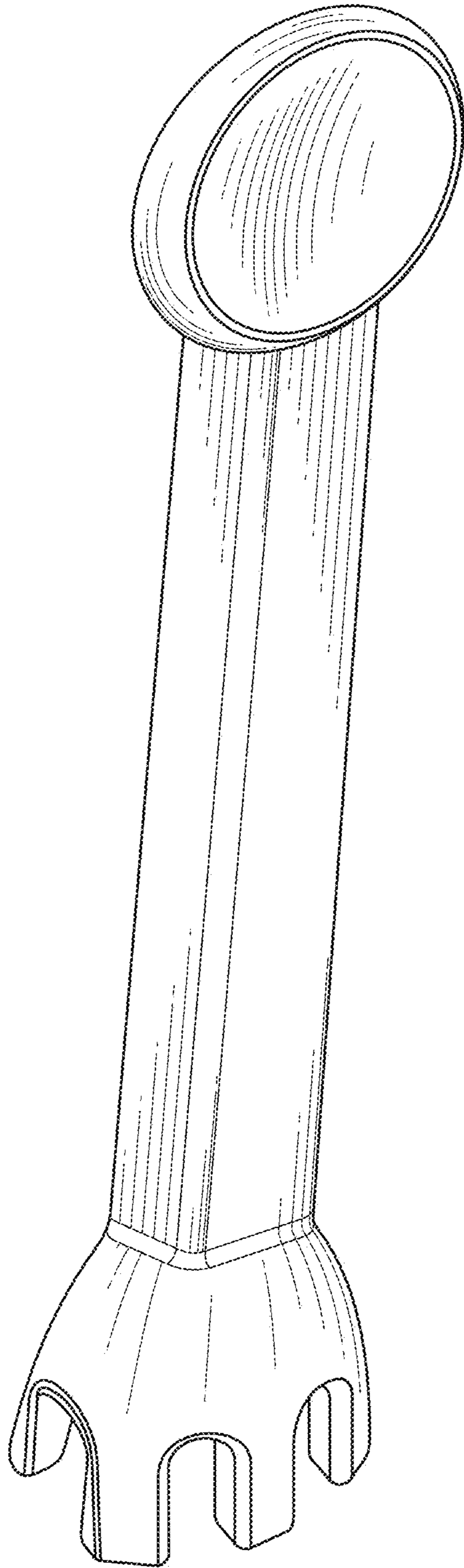

FIG. 8

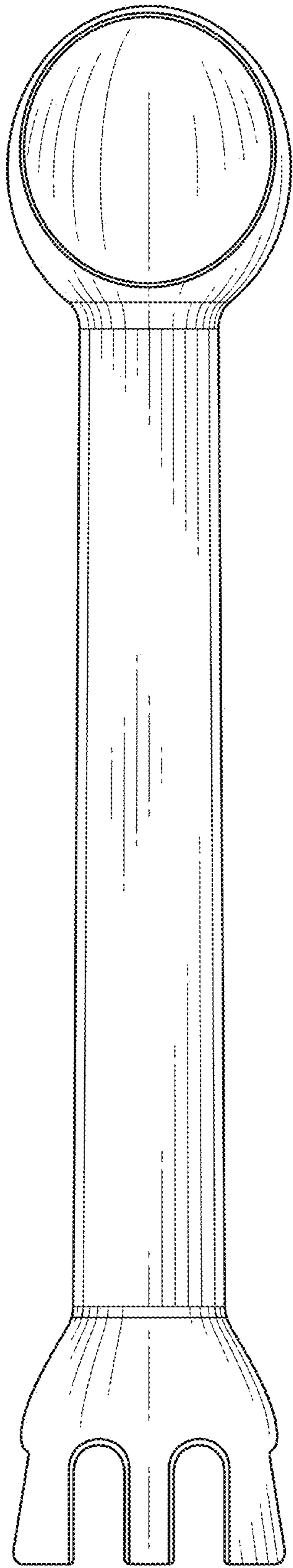

FIG. 9

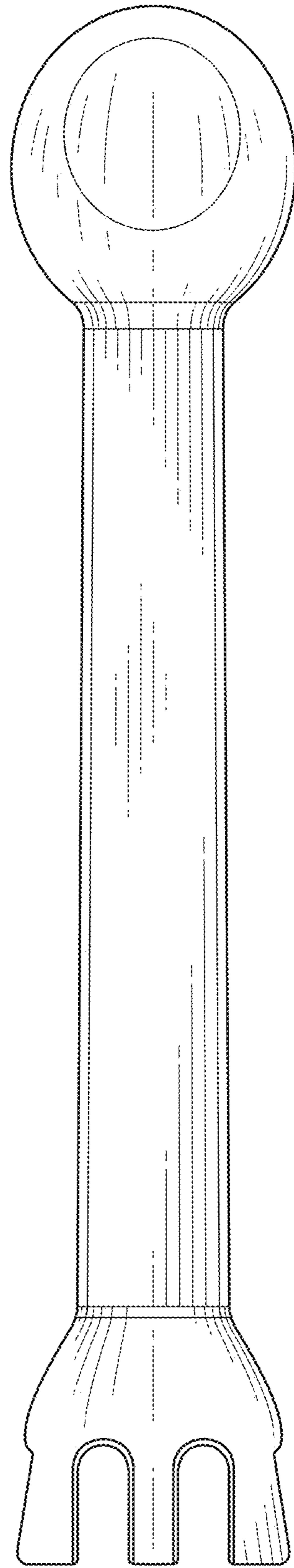

FIG. 10

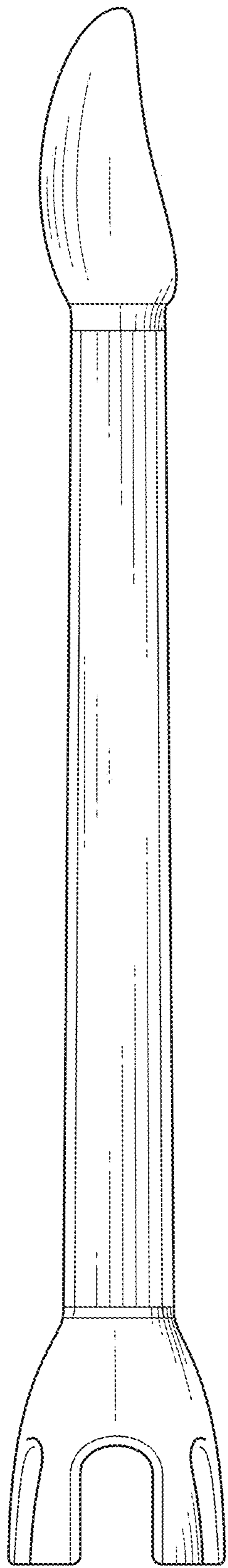

FIG. 11

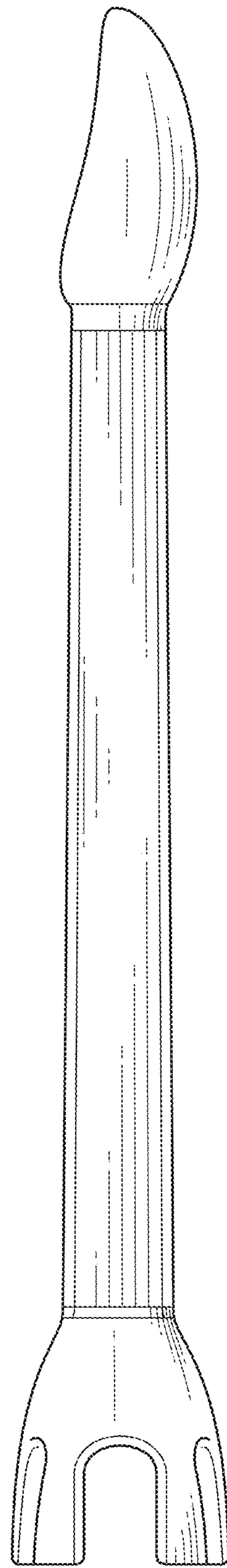

FIG. 12

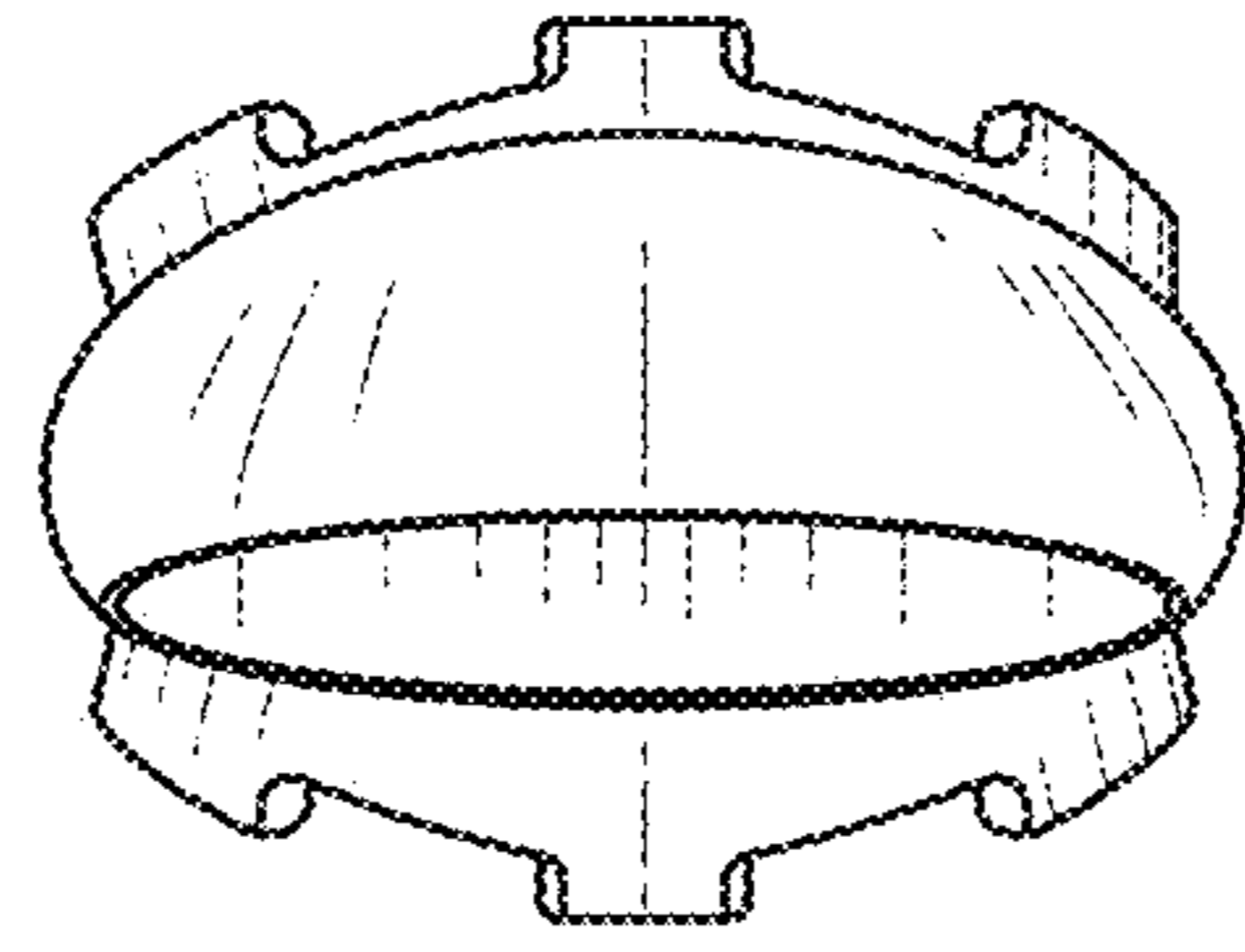

FIG. 13

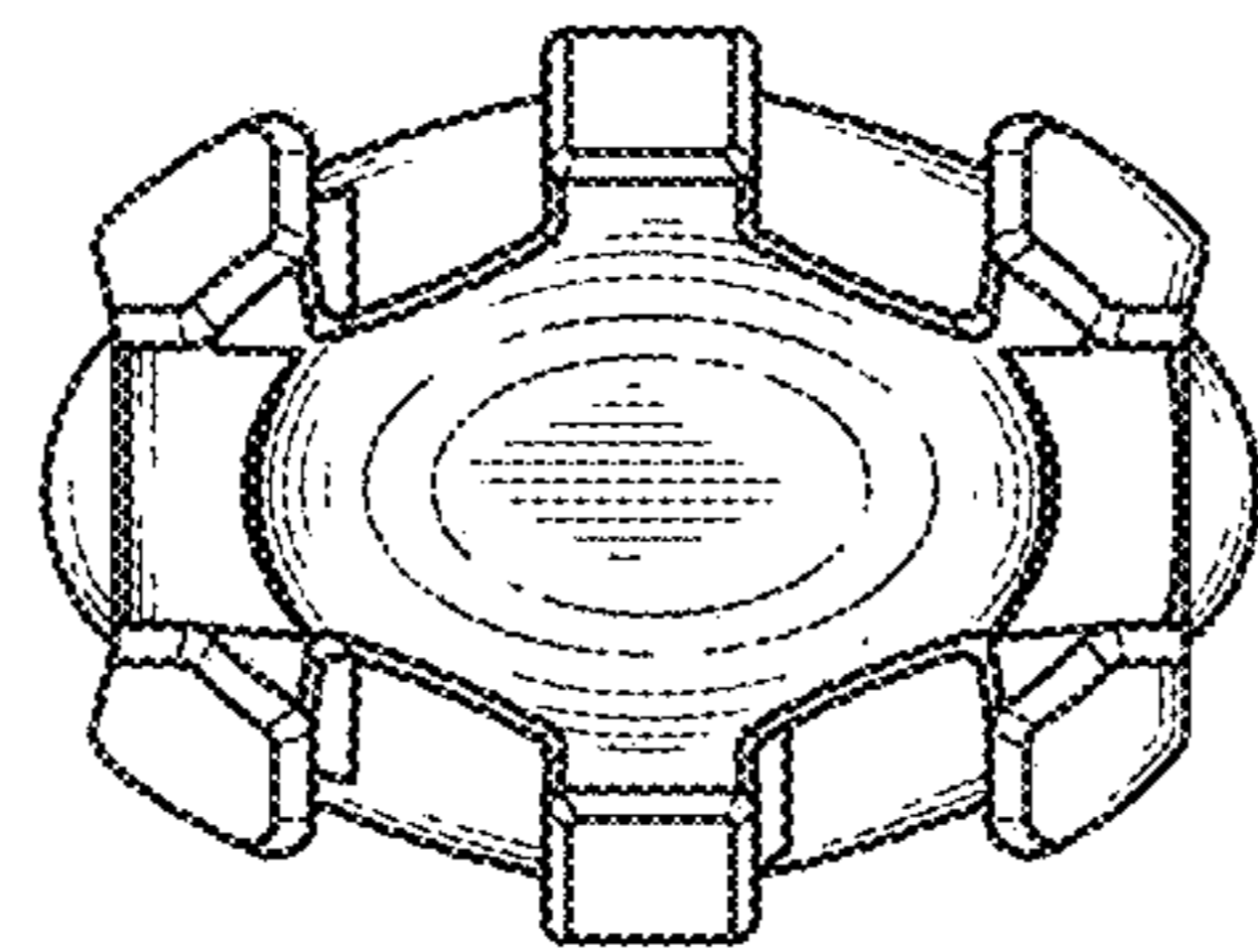

FIG. 14