



US00D897749S

(12) **United States Design Patent** (10) **Patent No.:** **US D897,749 S**  
**Hurford** (45) **Date of Patent:** **\*\* Oct. 6, 2020**

(54) **CHAIR**

(71) Applicant: **Okamura Corporation**, Yokohama-shi, Kanagawa (JP)

(72) Inventor: **Alexander Hurford**, Yokohama (JP)

(73) Assignee: **Okamura Corporation**, Yokohama-shi, Kanagawa (JP)

(\*\*) Term: **15 Years**

(21) Appl. No.: **29/701,416**

(22) Filed: **Aug. 12, 2019**

(56) **References Cited**

U.S. PATENT DOCUMENTS

|              |         |          |       |        |
|--------------|---------|----------|-------|--------|
| D138,511 S * | 8/1944  | Dreyfuss | ..... | D6/356 |
| D298,491 S * | 11/1988 | Haukvik  | ..... | D6/365 |
| D316,936 S * | 5/1991  | Ekornes  | ..... | D6/365 |
| D508,787 S * | 8/2005  | Natuzzi  | ..... | D6/364 |
| D531,420 S * | 11/2006 | Kita     | ..... | D6/364 |
| D540,572 S * | 4/2007  | Fanning  | ..... | D6/364 |
| D559,570 S * | 1/2008  | Higgs    | ..... | D6/364 |
| D600,033 S * | 9/2009  | Natuzzi  | ..... | D6/364 |
| D611,263 S * | 3/2010  | Werner   | ..... | D6/366 |
| D662,733 S * | 7/2012  | Metcalf  | ..... | D6/717 |
| D672,975 S * | 12/2012 | Rashid   | ..... | D6/335 |
| D677,918 S * | 3/2013  | Citterio | ..... | D6/366 |
| D684,785 S * | 6/2013  | Hwangbo  | ..... | D6/367 |

(Continued)

**Related U.S. Application Data**

(62) Division of application No. 29/641,901, filed on Mar. 26, 2018.

(30) **Foreign Application Priority Data**

|                    |       |             |
|--------------------|-------|-------------|
| Sep. 26, 2017 (JP) | ..... | 2017-020919 |
| Sep. 26, 2017 (JP) | ..... | 2017-020920 |
| Sep. 26, 2017 (JP) | ..... | 2017-020921 |

(51) **LOC (12) Cl.** ..... **06-06**

(52) **U.S. Cl.**  
USPC ..... **D6/716**

(58) **Field of Classification Search**  
USPC ..... D6/356, 360, 364, 365, 335, 366, 367, D6/375, 716, 719; D21/521, 533, 548  
CPC .... A61H 2201/0149; B60N 2/06; B60N 2/20; B60N 2/22; B60N 2/58; B60N 2/68; B60N 2/80; B60N 2/643; B60N 2/888; B60N 2/859; B60N 2/1615; B60N 2/7035; B60N 2/42745; B60N 2002/0272; B60N 2205/35; B60N 2/0252; B60N 2/99; B64D 11/064; B64D 11/0639; B64D 11/0646; B64D 33/0021; B64D 33/00

See application file for complete search history.

OTHER PUBLICATIONS

U.S. Appl. No. 29/701,422, filed Aug. 12, 2019.

*Primary Examiner* — Kevin K Rudzinski  
*Assistant Examiner* — Paul D Bohannon  
(74) *Attorney, Agent, or Firm* — Banner & Witcoff, Ltd.

(57) **CLAIM**

The ornamental design for a chair, as shown and described.

**DESCRIPTION**

FIG. 1 is a front perspective view of a chair showing my new design;  
FIG. 2 is a rear perspective view thereof;  
FIG. 3 is a front view thereof;  
FIG. 4 is a rear view thereof;  
FIG. 5 is a right side view thereof, the left side view being a mirror image thereof;  
FIG. 6 is a top view thereof; and,  
FIG. 7 is a bottom view thereof.  
The broken lines shown in the drawings illustrate portions of the chair that form no part of the claimed design.

**1 Claim, 7 Drawing Sheets**

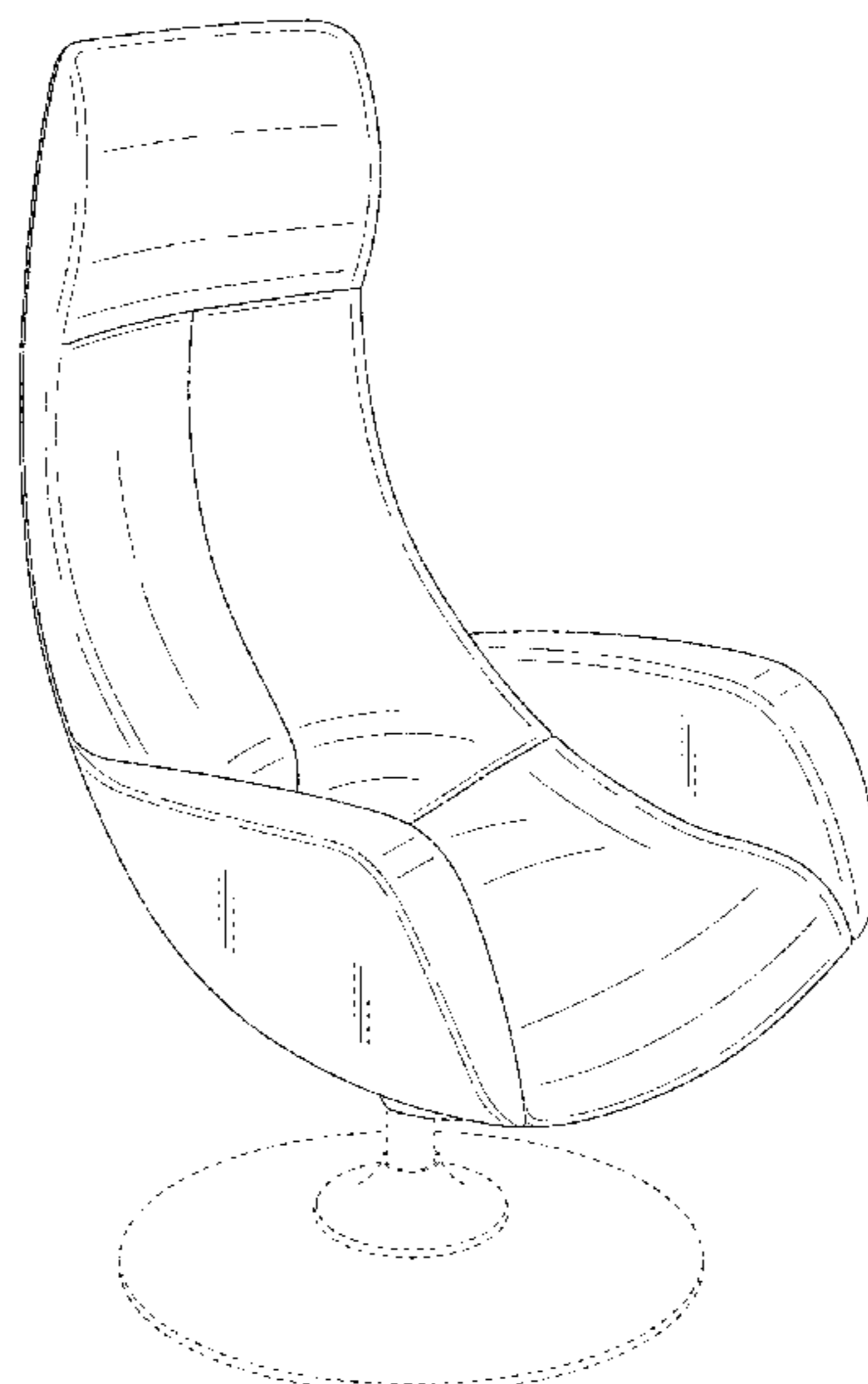

(56)

## References Cited

## U.S. PATENT DOCUMENTS

D698,162 S \* 1/2014 Kita ..... D6/335  
D701,719 S \* 4/2014 Haase ..... D6/719  
D704,465 S \* 5/2014 Massaud ..... D6/364  
D704,466 S \* 5/2014 Massaud ..... D6/364  
D704,488 S \* 5/2014 Massaud ..... D6/716  
D717,555 S \* 11/2014 Massaud ..... D6/364  
D763,589 S \* 8/2016 Mion ..... D6/375  
D799,844 S \* 10/2017 Aamodt ..... D6/366  
9,828,101 B2 11/2017 Shih  
D824,185 S \* 7/2018 Wang ..... D6/367  
D824,689 S \* 8/2018 Jongerius ..... D6/375  
10,081,285 B2 9/2018 Kaneda et al.  
10,144,312 B2 12/2018 Akaike  
D839,622 S \* 2/2019 Oyama ..... D6/356  
D848,162 S \* 5/2019 Yin ..... D6/335  
D852,527 S \* 7/2019 Heydari ..... D6/366  
2011/0254341 A1 \* 10/2011 Potter ..... A47C 4/02  
297/440.1  
2017/0096084 A1 \* 4/2017 Akaike ..... B64D 11/0639  
2017/0096085 A1 \* 4/2017 Akaike ..... B64D 11/0639  
2017/0217341 A1 \* 8/2017 Kaneda ..... B60N 2/99  
2017/0291511 A1 \* 10/2017 Akaike ..... B60N 2/4221  
2017/0297460 A1 \* 10/2017 Akaike ..... B60N 2/4235

\* cited by examiner

Fig. 1

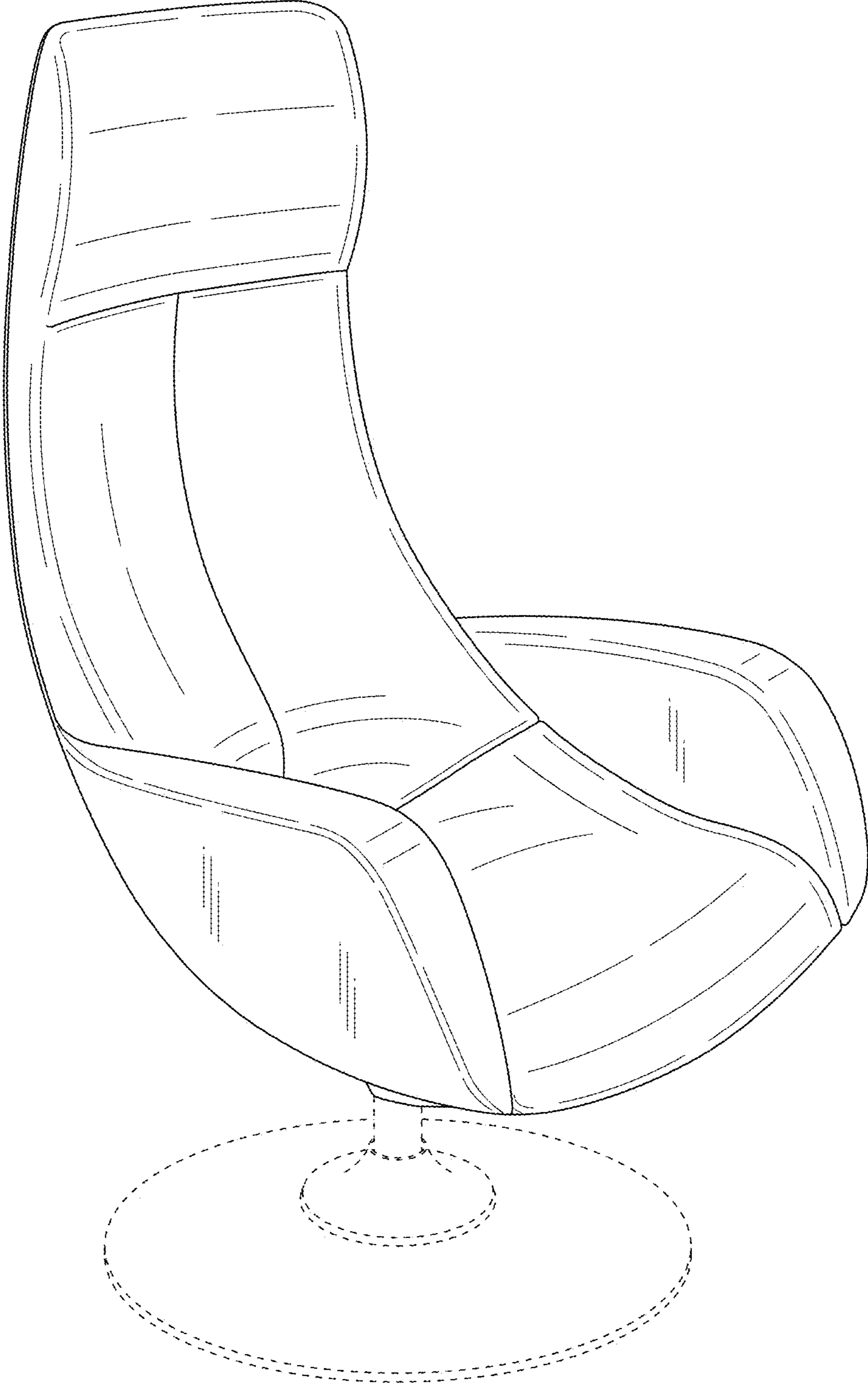

Fig. 2

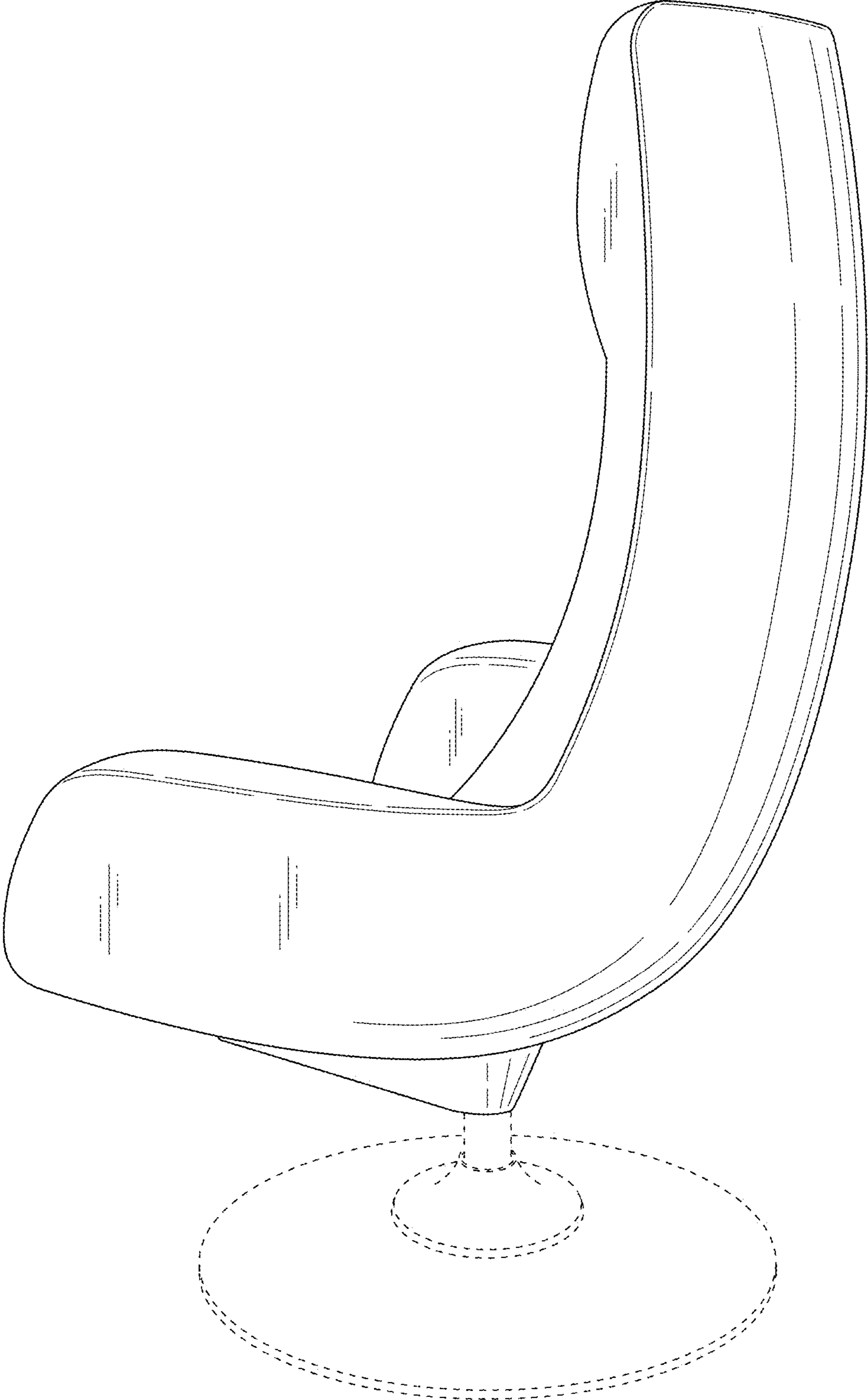

Fig. 3

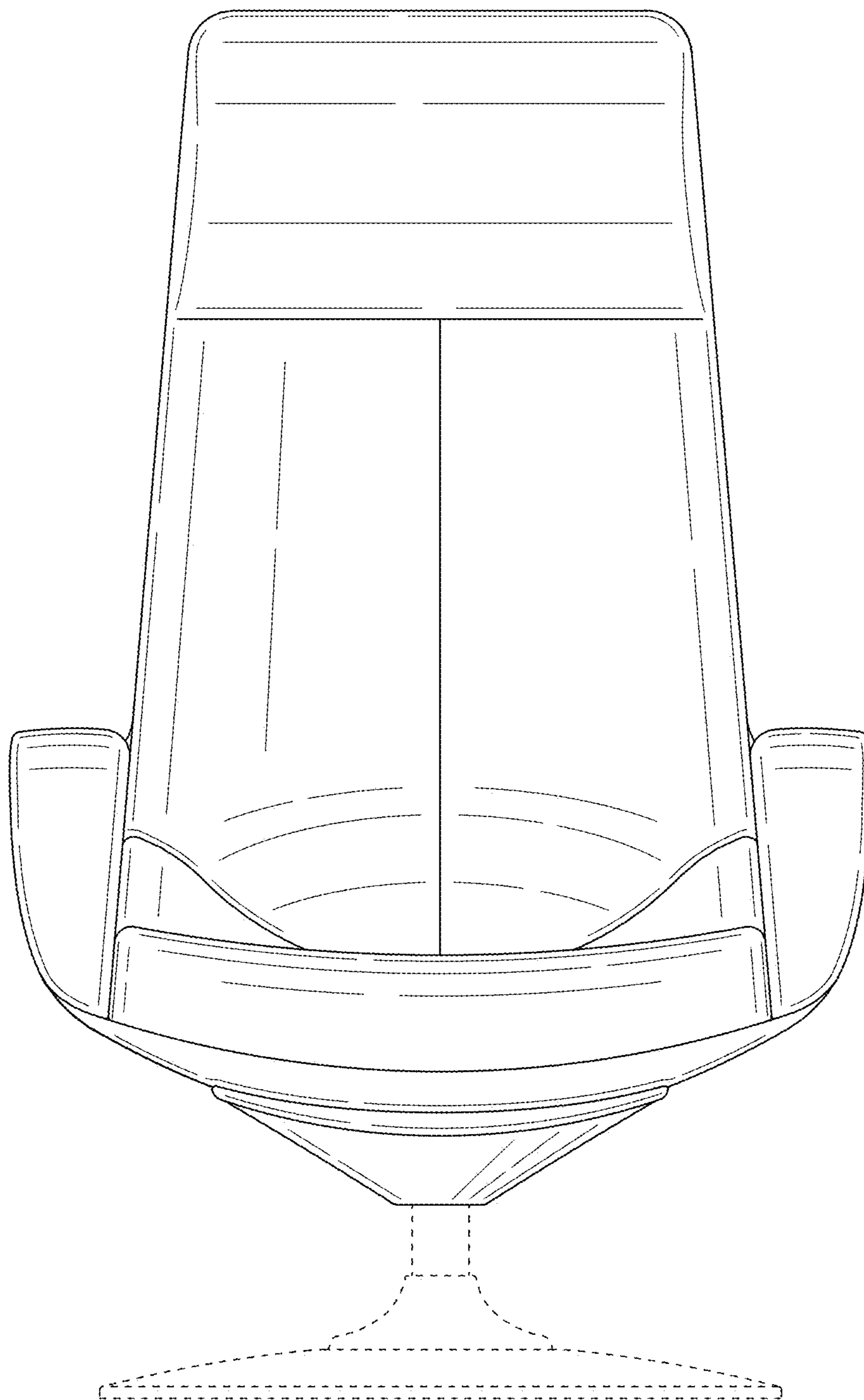

Fig. 4

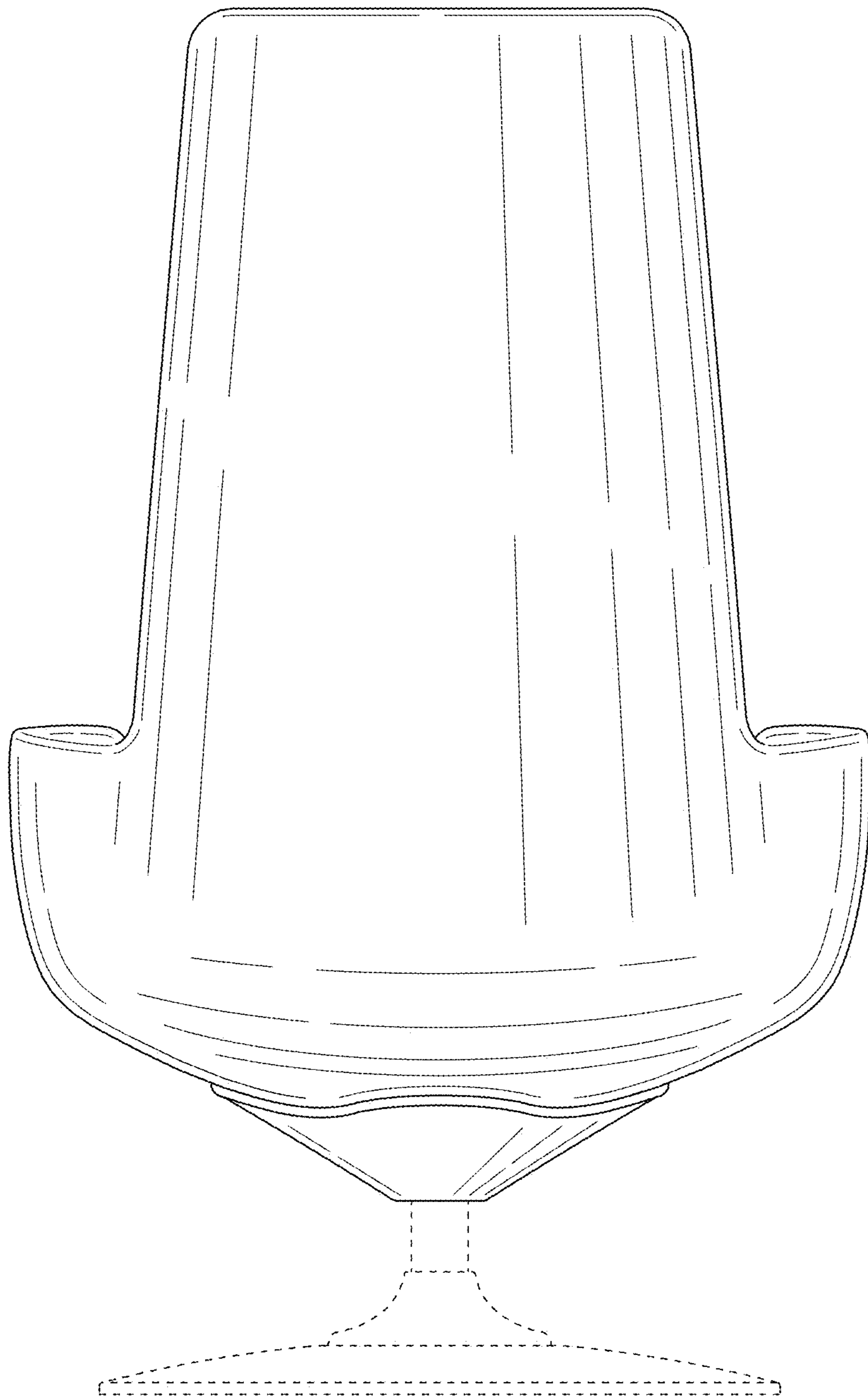

Fig. 5

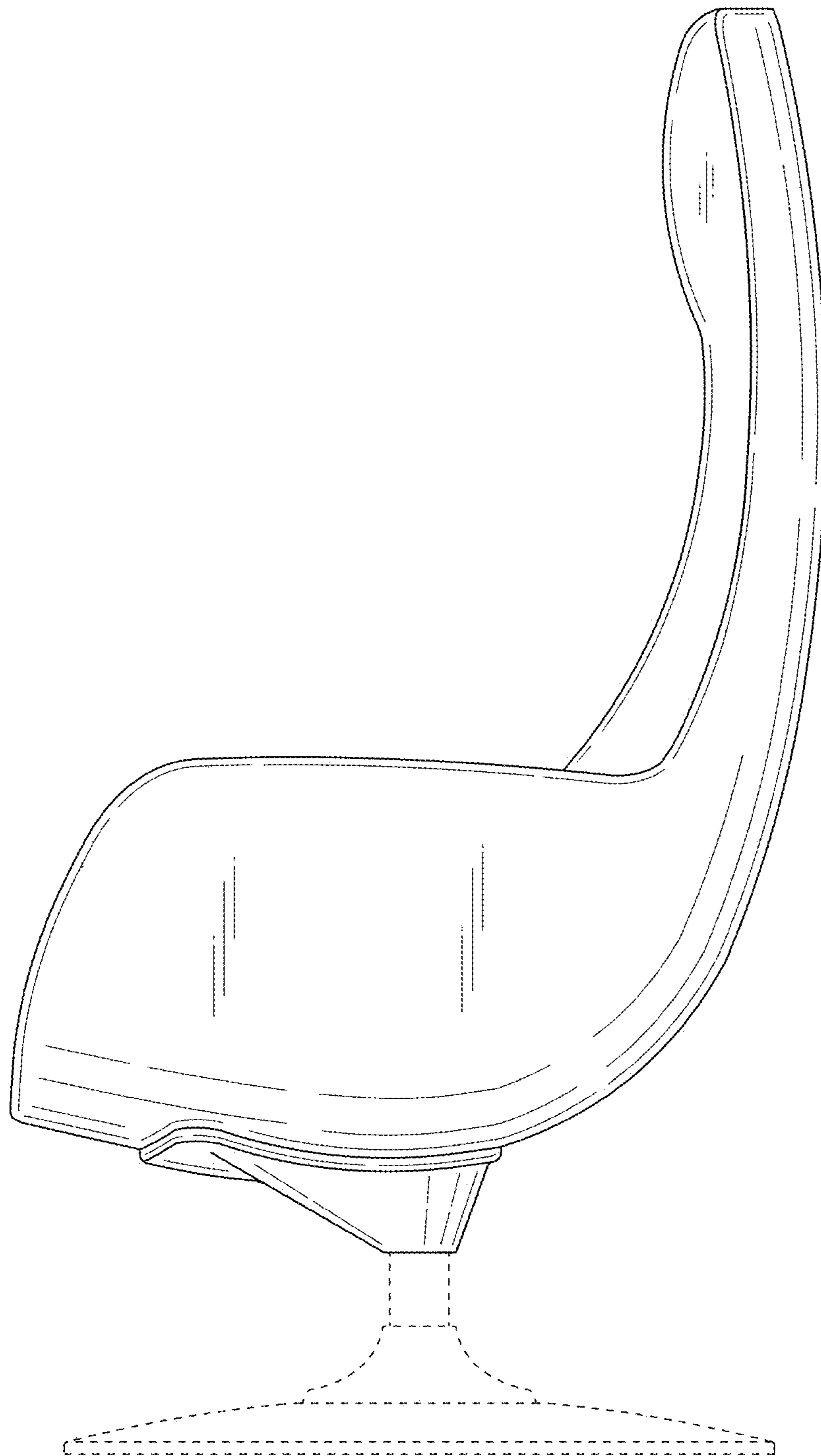

Fig. 6

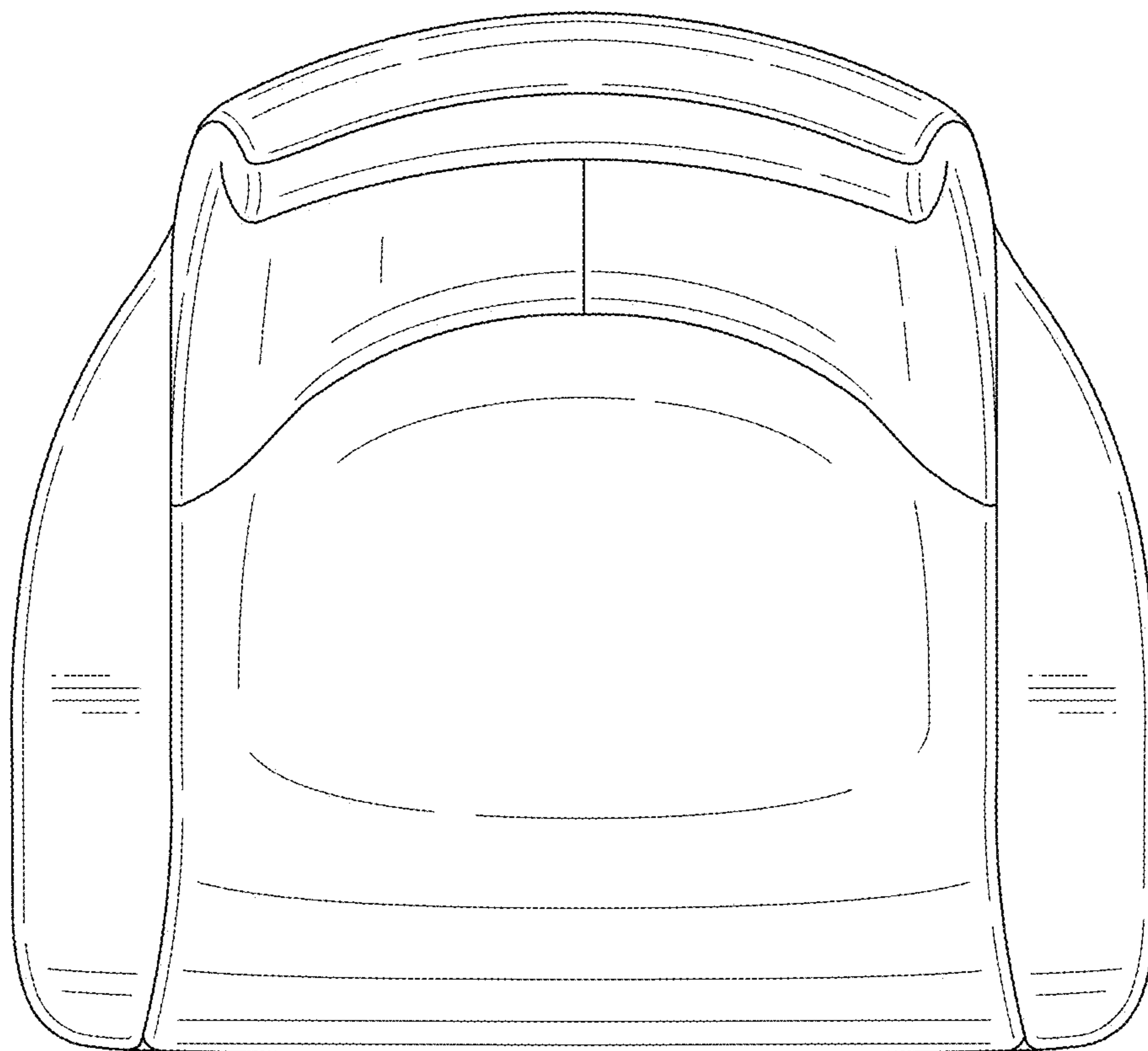



Fig. 7

