



US00D897706S

(12) **United States Design Patent**  
**Zhang et al.**

(10) **Patent No.:** **US D897,706 S**

(45) **Date of Patent:** **\*\* Oct. 6, 2020**

(54) **POLYGONAL INFLATABLE SOFA**

(71) Applicants: **Penghe Zhang**, Guangdong (CN);  
**Weijun Tang**, Guangdong (CN)

(72) Inventors: **Penghe Zhang**, Guangdong (CN);  
**Weijun Tang**, Guangdong (CN)

(73) Assignee: **Shenzhen Xinaosheng Technology Co., Ltd.**, Shenzhen, Guangdong (CN)

(\*\*) Term: **15 Years**

(21) Appl. No.: **29/696,855**

(22) Filed: **Jul. 2, 2019**

(51) **LOC (12) Cl.** ..... **06-01**

(52) **U.S. Cl.**  
USPC ..... **D6/361**

(58) **Field of Classification Search**  
USPC ..... D6/334, 349, 360, 362, 374–377, 379,  
D6/381, 716, 716.1, 719.3  
CPC .. A47C 1/00; A47C 1/02; A47C 1/024; A47C  
1/028; A47C 1/037; A47C 3/00; A47C  
3/04; A47C 3/14; A47C 3/20; A47C  
7/002; A47C 7/16; A47C 7/18; A47C  
4/04; A47C 4/08; A47C 4/18; A47C 4/28;  
A47C 4/54; A47C 11/00; A47C 9/007;  
A47C 13/00; A47C 15/002; A47C 17/02;  
A47C 31/11

See application file for complete search history.

(56) **References Cited**

U.S. PATENT DOCUMENTS

D214,623 S \* 7/1969 Williams ..... D6/377  
3,584,914 A \* 6/1971 Williams ..... A47C 4/54  
297/452.41

D240,480 S \* 7/1976 Marks ..... D6/377  
D361,215 S \* 8/1995 Honeycutt, Sr. .... D6/381  
D764,823 S \* 8/2016 Oomen ..... D6/361  
D783,300 S \* 4/2017 Pinholster, Jr. .... D6/361  
D804,208 S \* 12/2017 Lam ..... D6/361  
D819,994 S \* 6/2018 Yang ..... D6/361  
D829,460 S \* 10/2018 Schnermann ..... D6/361  
D837,552 S \* 1/2019 Schnermann ..... D6/361  
D866,210 S \* 11/2019 Zhu ..... D6/361  
2011/0272989 A1\* 11/2011 Cho ..... A47C 3/16  
297/391  
2018/0317657 A1\* 11/2018 Yang ..... A47C 3/16

\* cited by examiner

*Primary Examiner* — R. Johnson

(57) **CLAIM**

The ornamental design for a polygonal inflatable sofa, as shown and described.

**DESCRIPTION**

FIG. 1 is a perspective view of a polygonal inflatable sofa showing my new design;  
FIG. 2 is a front elevation view thereof;  
FIG. 3 is a rear elevation view thereof;  
FIG. 4 is a left side elevation view thereof;  
FIG. 5 is a right side elevation view thereof;  
FIG. 6 is a top plan view thereof; and,  
FIG. 7 is a bottom plan view thereof.  
The broken lines in the drawing figures depict stitching, which is not part of the claimed design.

**1 Claim, 7 Drawing Sheets**

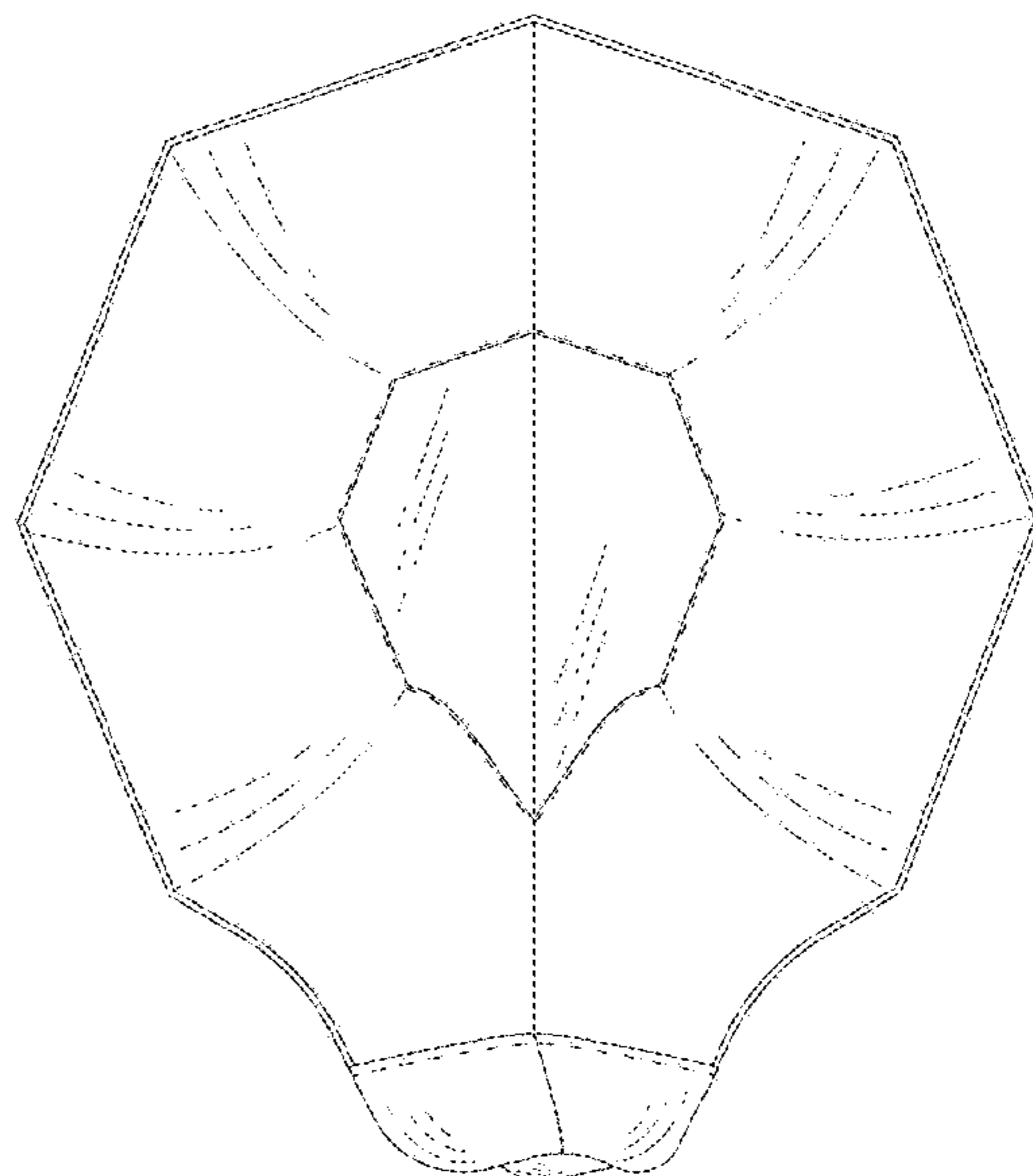
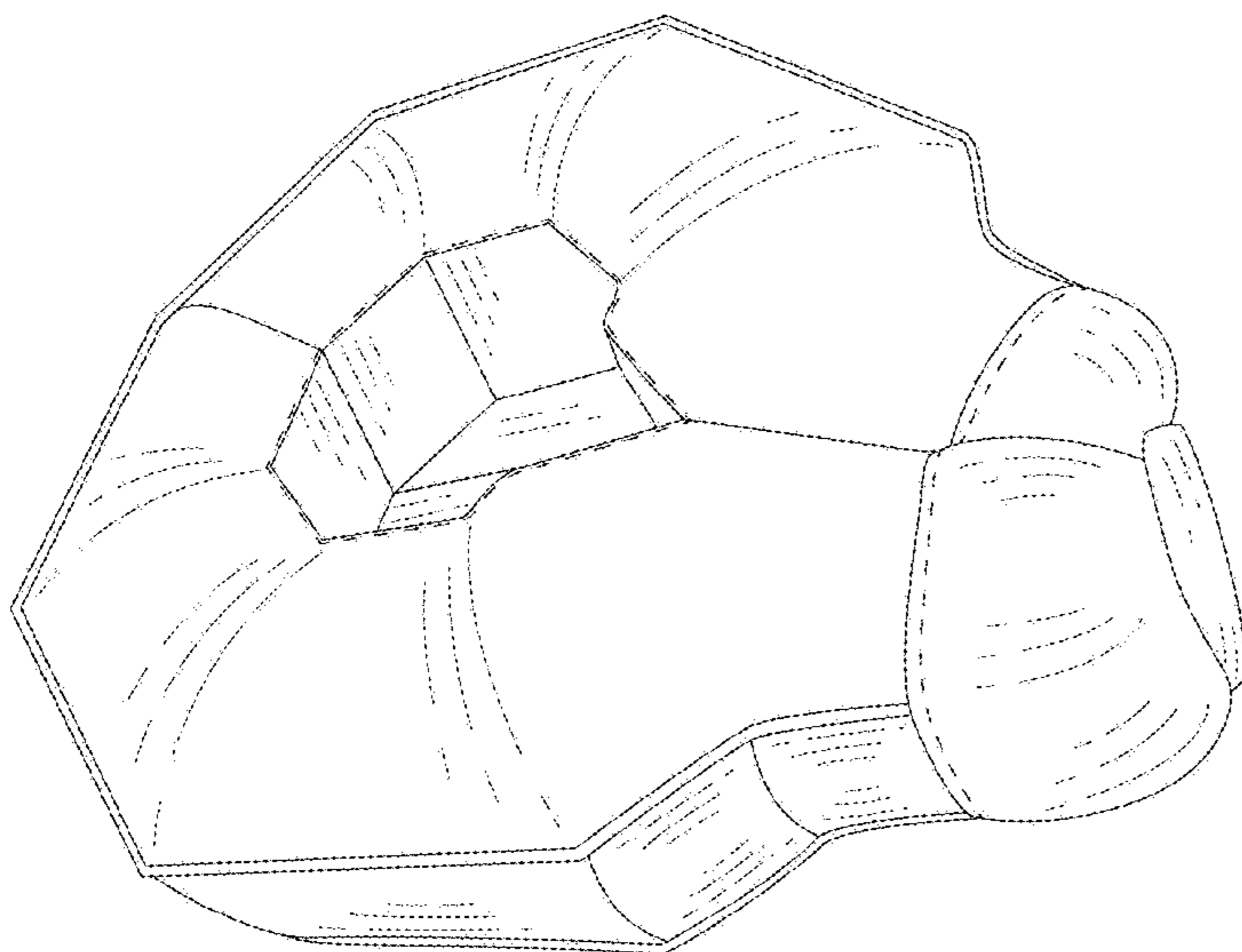

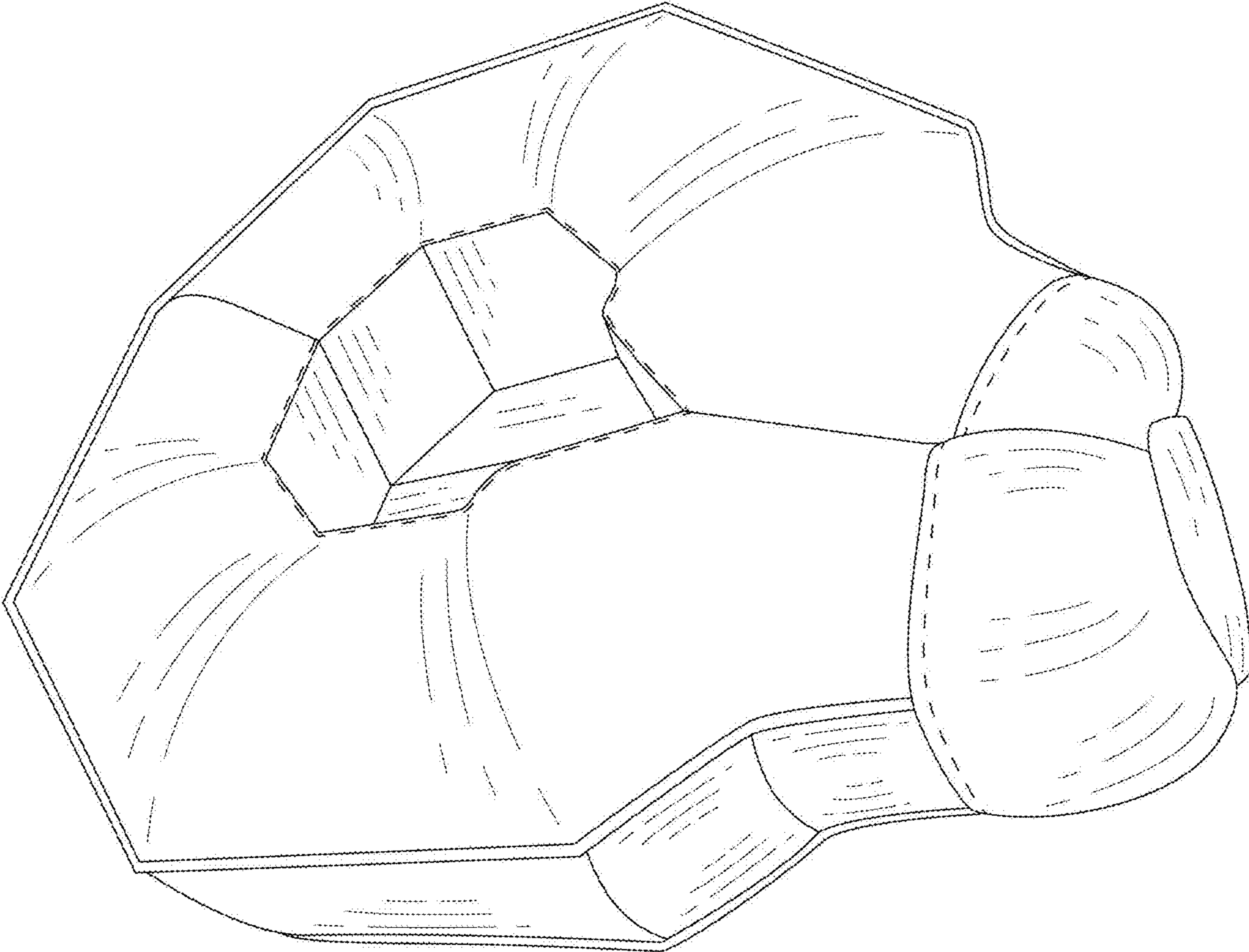

FIG.1

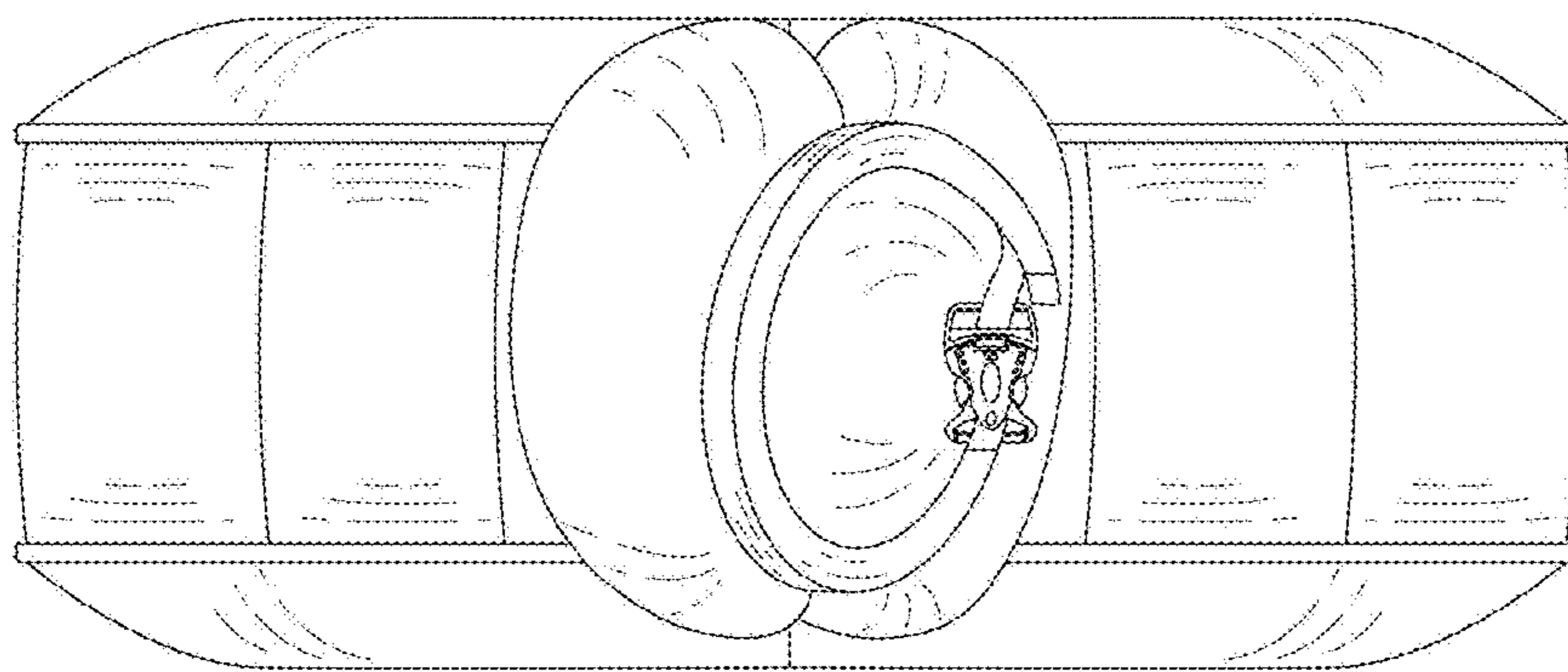

FIG.2

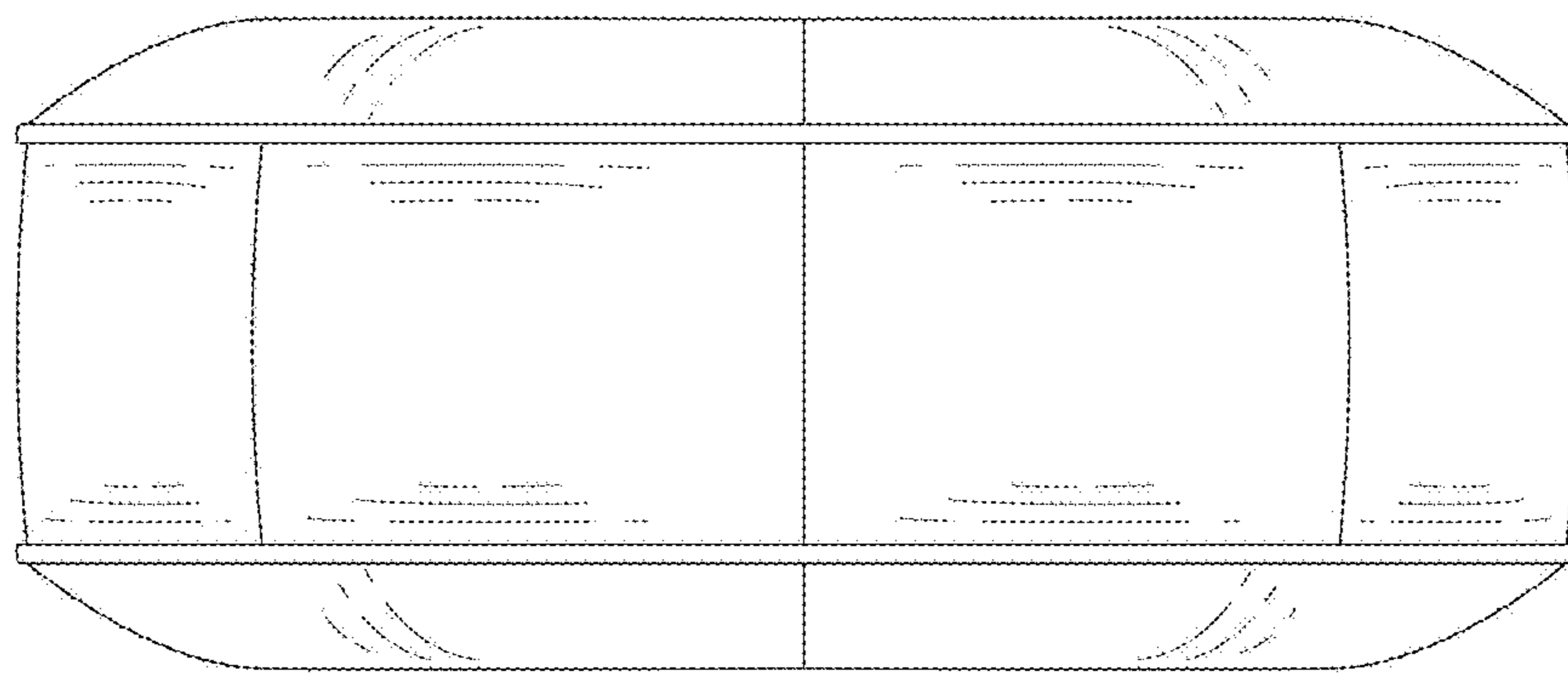

FIG.3

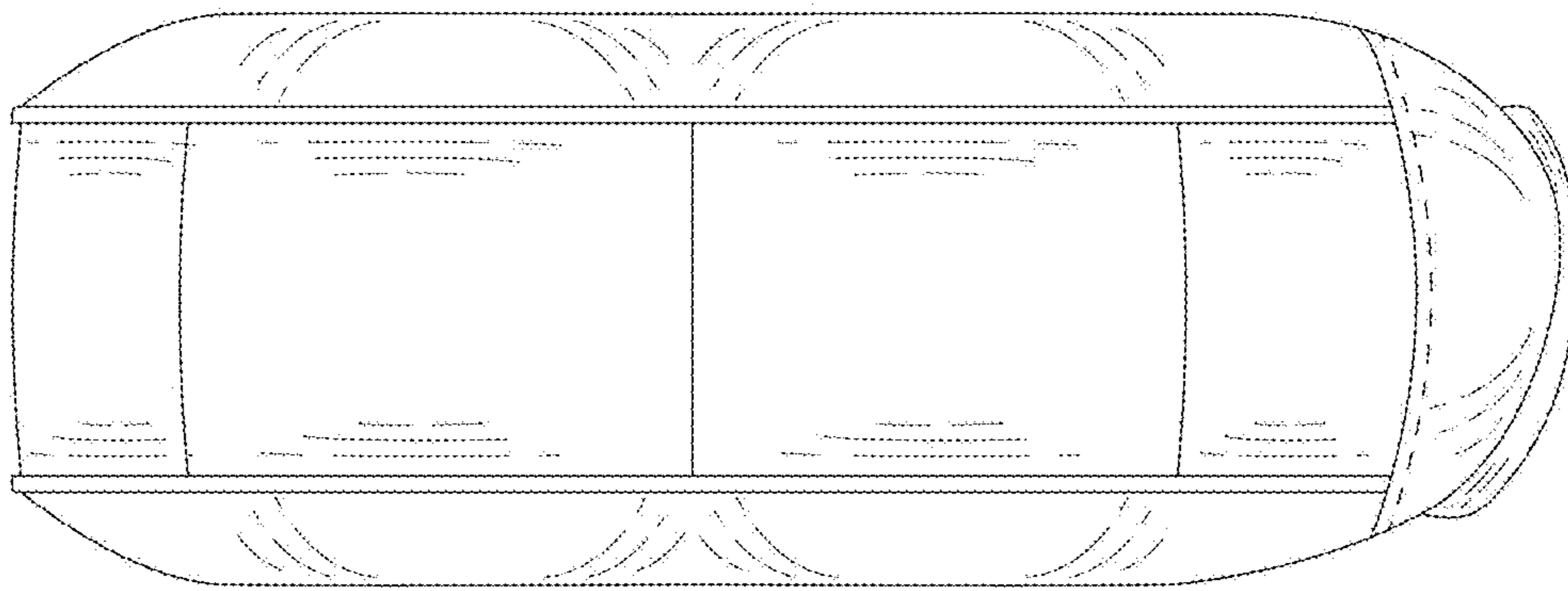

FIG.4

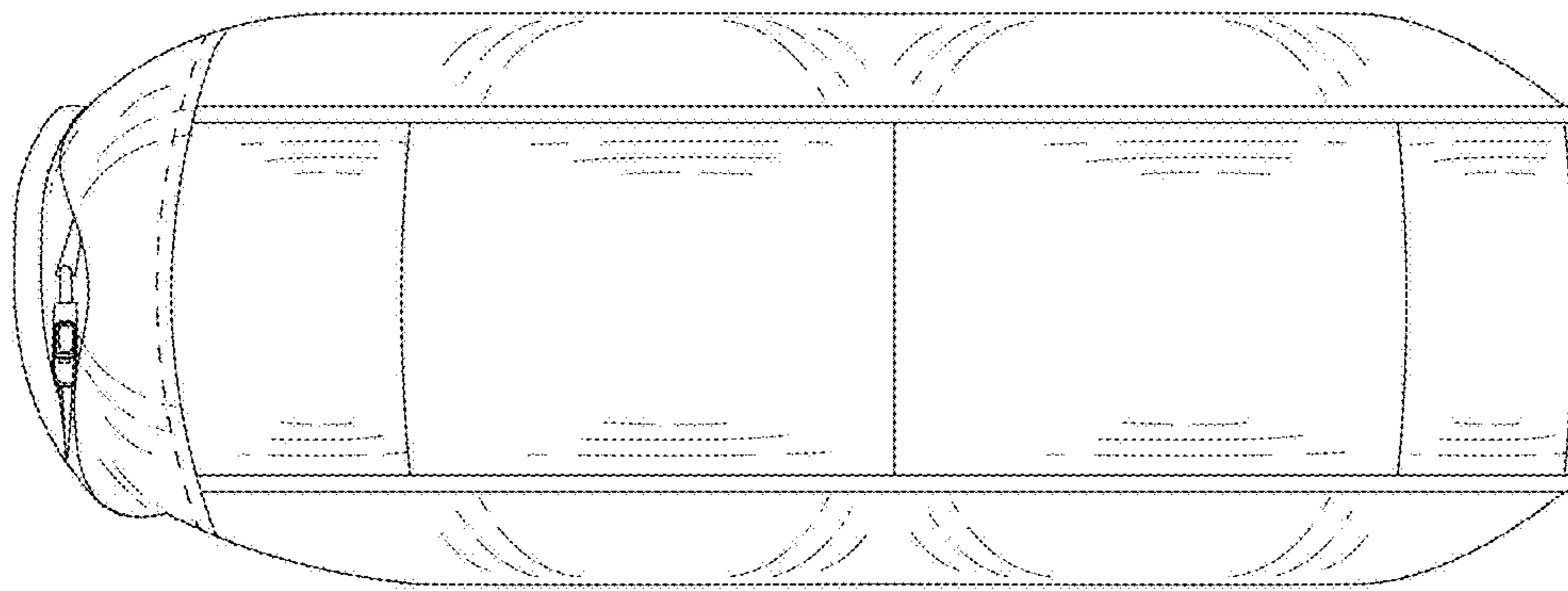

FIG. 5

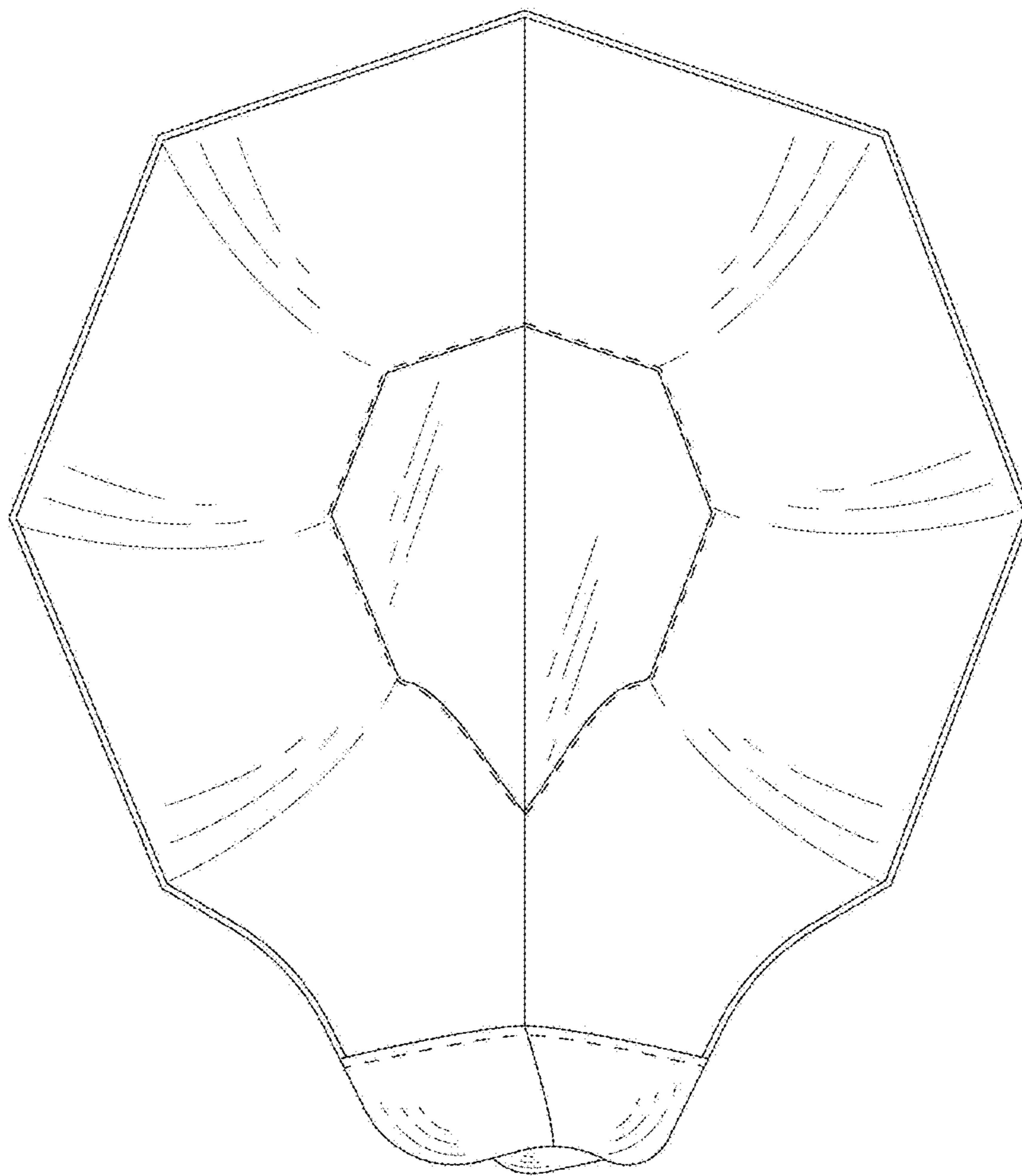

FIG. 6

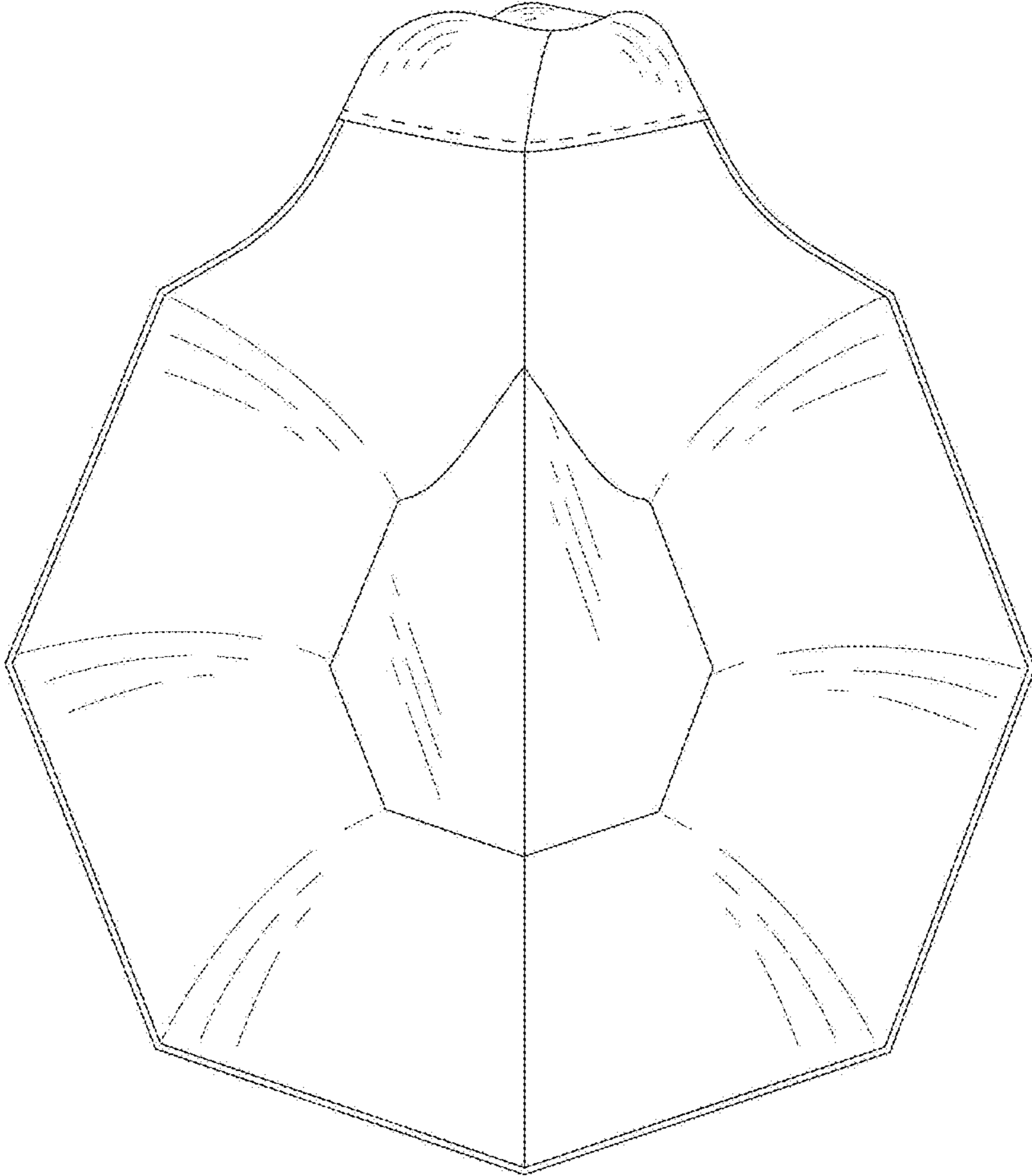

FIG. 7