



US00D897686S

(12) **United States Design Patent** (10) **Patent No.:** **US D897,686 S**  
**To** (45) **Date of Patent:** **\*\* Oct. 6, 2020**

(54) **TOOTHBRUSH**

(71) Applicant: **World Wide Daily Holdings Company Limited**, New Territories, Hong Kong (CN)

(72) Inventor: **Chun Yuen To**, Hong Kong (CN)

(73) Assignee: **World Wide Daily Holdings Company Limited**, Kwai Chung, New Territories (HK)

(\*\*) Term: **15 Years**

(21) Appl. No.: **29/673,499**

(22) Filed: **Dec. 14, 2018**

(51) **LOC (12) Cl.** ..... **04-02**

(52) **U.S. Cl.**  
USPC ..... **D4/104**

(58) **Field of Classification Search**  
USPC ..... D4/104, 105, 106, 107, 108, 109, 110,  
D4/111, 112, 113, 129, 136, 138, 199,  
D4/101, 137

(Continued)

(56) **References Cited**

**U.S. PATENT DOCUMENTS**

1,353,780 A 9/1920 Mueller  
1,452,108 A 4/1923 Carter

(Continued)

**FOREIGN PATENT DOCUMENTS**

CA 138963 11/2011  
CN 201315965 Y 9/2009

(Continued)

**OTHER PUBLICATIONS**

Ex Parte Quayle Action dated Mar. 11, 2020 in related U.S. Appl. No. 29/673,493, 4 pages.

(Continued)

*Primary Examiner* — Karen E Eldridge Powers

(74) *Attorney, Agent, or Firm* — Stinson LLP

(57) **CLAIM**

The ornamental design for a toothbrush, as shown and described.

**DESCRIPTION**

FIG. 1 is a perspective view of a toothbrush showing a handle of the toothbrush in phantom;

FIG. 2 is an enlarged fragmentary view taken from FIG. 1;

FIG. 3 is a front elevation view of the toothbrush;

FIG. 4 is a top plan view of the toothbrush;

FIG. 5 is a rear elevation view of the toothbrush;

FIG. 6 is a bottom plan view of the toothbrush;

FIG. 7 is a right side elevation view of the toothbrush;

FIG. 8 is a left side elevation view of the toothbrush;

FIG. 9 is a perspective view of another embodiment of a toothbrush showing a handle of the toothbrush in phantom;

FIG. 10 is an enlarged fragmentary view taken from FIG. 9;

FIG. 11 is a front elevation view of the toothbrush illustrated in FIG. 9;

FIG. 12 is a top plan view of the toothbrush illustrated in FIG. 9;

FIG. 13 is a rear elevation view of the toothbrush illustrated in FIG. 9;

FIG. 14 is a bottom plan view of the toothbrush illustrated in FIG. 9;

FIG. 15 is a right side elevation view of the toothbrush illustrated in FIG. 9; and,

FIG. 16 is a left side elevation view of the toothbrush illustrated in FIG. 9.

The broken-away lines indicate that any portion of the article beyond what is shown forms no part of the claimed design.

**1 Claim, 14 Drawing Sheets**

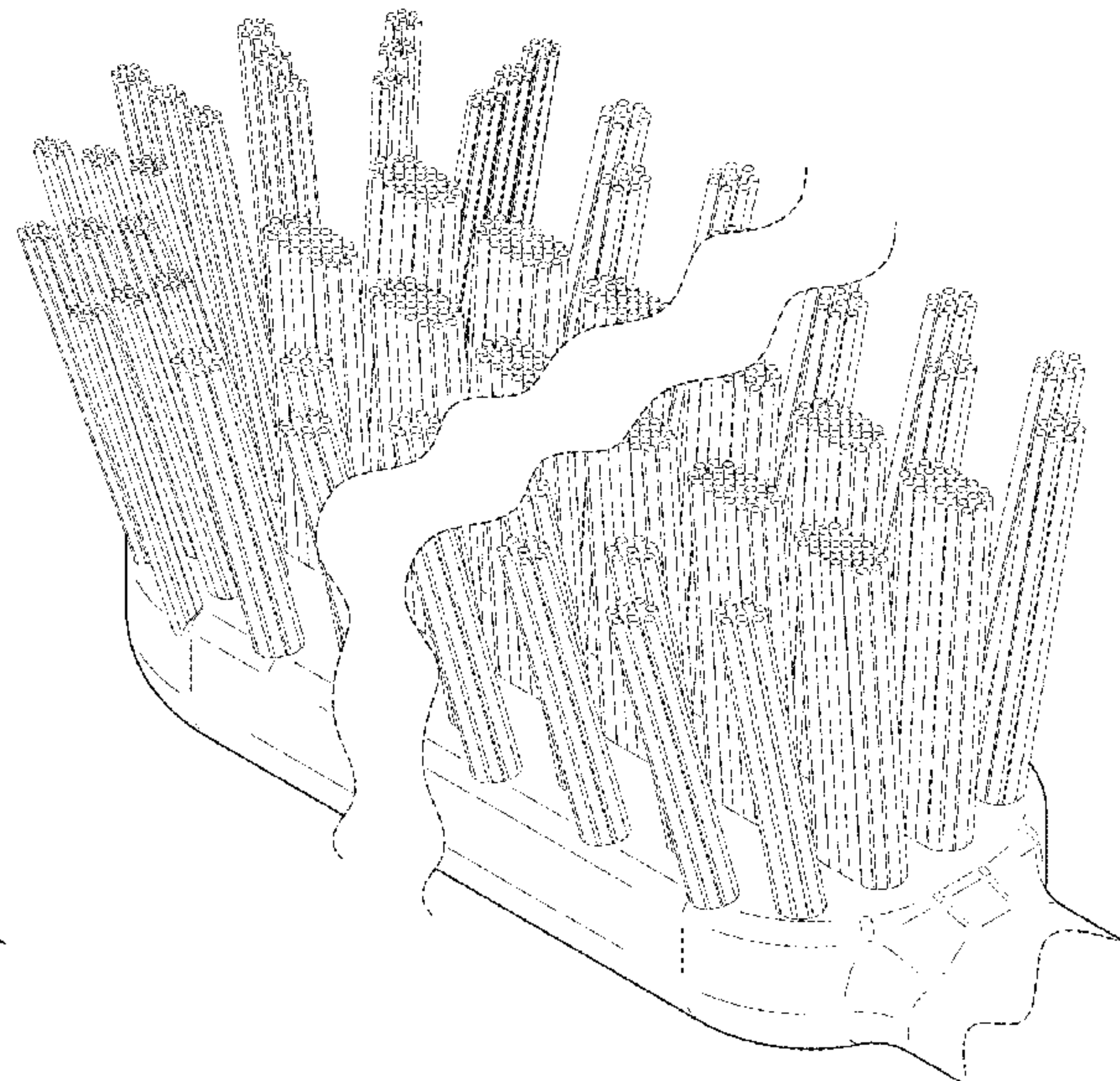
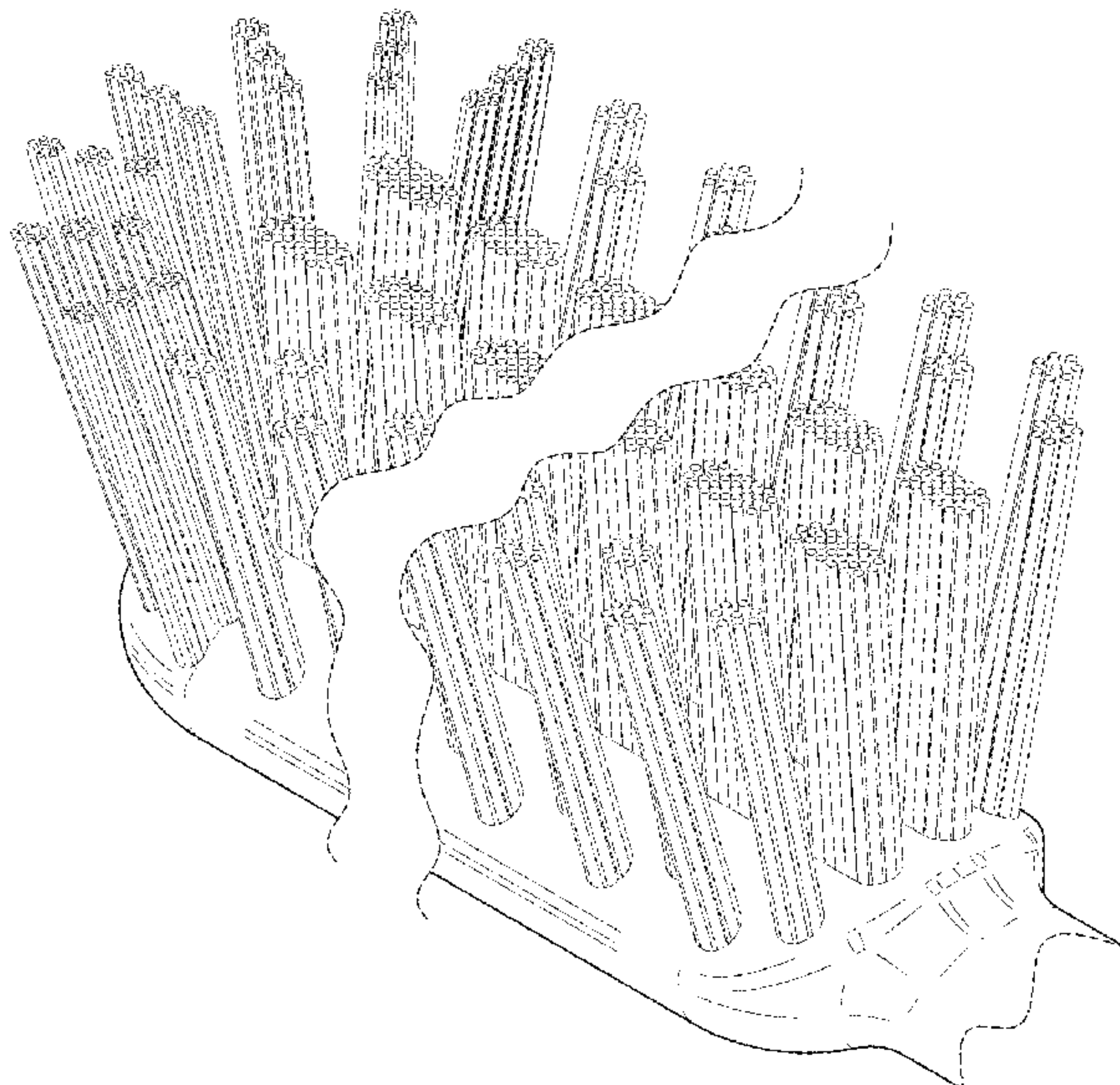



(58) **Field of Classification Search**

CPC ..... A61C 17/16; A61C 17/22; A61C 17/32;  
 A61C 17/34; A61C 17/228; A46B 9/025;  
 A46B 9/026; A46B 9/045; A46B 9/04  
 See application file for complete search history.

(56) **References Cited**

U.S. PATENT DOCUMENTS

1,900,326 A 3/1933 Beresford  
 2,360,745 A \* 10/1944 Vogel ..... A46B 5/02  
 15/167.1  
 D140,438 S 2/1945 Cohen  
 2,706,825 A 4/1955 Blakeman  
 3,103,027 A \* 9/1963 Birch ..... A46B 15/0075  
 15/110  
 3,722,020 A \* 3/1973 Hills ..... A46B 9/04  
 15/167.1  
 D239,221 S \* 3/1976 Wasserman ..... D4/104  
 D240,981 S \* 8/1976 Hill et al. .... D4/104  
 4,010,509 A \* 3/1977 Huish ..... A46B 9/045  
 15/167.1  
 D251,038 S \* 2/1979 Hill ..... D4/104  
 4,274,174 A 6/1981 Ertel  
 D321,987 S \* 12/1991 Oates ..... D4/106  
 D336,369 S \* 6/1993 Harden ..... D4/104  
 D341,254 S \* 11/1993 Knox ..... D4/106  
 5,341,537 A 8/1994 Curtis et al.  
 5,355,546 A 10/1994 Scheier et al.  
 5,392,483 A \* 2/1995 Heinzelman ..... A46B 9/04  
 15/167.1  
 D372,363 S 8/1996 Halm  
 5,544,383 A 8/1996 Gamble  
 5,570,487 A 11/1996 Schneider  
 D387,205 S \* 12/1997 Moskovich ..... D4/104  
 D399,349 S \* 10/1998 Barth ..... D4/106  
 D402,116 S 12/1998 Magloff et al.  
 D402,117 S 12/1998 Fleming et al.  
 5,845,358 A \* 12/1998 Woloch ..... A46B 15/0055  
 15/111  
 5,881,425 A 3/1999 Hudson et al.  
 D416,136 S \* 11/1999 Watanabe ..... D4/104  
 D434,565 S 12/2000 Bojar  
 D443,142 S 6/2001 Harada  
 D443,985 S \* 6/2001 Beals ..... D4/104  
 D444,629 S 7/2001 Etter et al.  
 D446,941 S 8/2001 Kraemer  
 6,493,897 B2 12/2002 Culbreth  
 6,496,999 B1 12/2002 Gleason et al.  
 D501,084 S 1/2005 Schaefer et al.  
 D513,667 S \* 1/2006 Moskovich ..... D4/104  
 D514,321 S 2/2006 Moskovich et al.  
 D514,815 S \* 2/2006 Moskovich ..... D4/104  
 D527,526 S \* 9/2006 Kling ..... D4/104  
 D528,802 S \* 9/2006 Moskovich ..... D4/104  
 D530,923 S \* 10/2006 Kling ..... D4/104  
 D531,414 S \* 11/2006 Wong ..... D4/104  
 D549,459 S 8/2007 Crossman  
 D579,664 S 11/2008 Fisher et al.  
 D596,404 S \* 7/2009 Xi ..... D4/104  
 D617,562 S \* 6/2010 Jin ..... D4/104  
 D646,490 S \* 10/2011 Pires ..... D4/136  
 8,327,492 B2 12/2012 Cann  
 D687,229 S \* 8/2013 Stebila ..... D4/108  
 D698,553 S \* 2/2014 Evans ..... D4/104

8,813,292 B2 8/2014 Driesen et al.  
 D723,807 S \* 3/2015 Wong ..... D4/104  
 9,210,995 B2 12/2015 Su et al.  
 9,357,837 B2 6/2016 Henderson et al.  
 D778,062 S 2/2017 Schmid et al.  
 D796,847 S \* 9/2017 Xi ..... D4/104  
 D798,062 S \* 9/2017 Bauernfeind ..... D4/104  
 D799,836 S \* 10/2017 Bauernfeind ..... D4/104  
 9,788,643 B2 \* 10/2017 Ji ..... A46B 9/04  
 D801,697 S \* 11/2017 Zwimpfer ..... D4/104  
 D818,274 S \* 5/2018 Bauernfeind ..... D4/105  
 D830,702 S \* 10/2018 Mu ..... D4/104  
 2011/0179594 A1 \* 7/2011 Zini ..... A46B 7/06  
 15/167.1  
 2013/0227804 A1 \* 9/2013 Fritsch ..... A61C 17/349  
 15/110  
 2014/0033457 A1 2/2014 Brown, Jr. et al.  
 2016/0157973 A1 \* 6/2016 Greco ..... A61C 15/048  
 132/309  
 2016/0174698 A1 6/2016 Huang  
 2019/0200748 A1 \* 7/2019 Gorich ..... A46B 5/0095

FOREIGN PATENT DOCUMENTS

CN 201624281 U 11/2010  
 CN 301517887 S 4/2011  
 CN 301555648 S 5/2011  
 CN 301569353 S 6/2011  
 CN 202269590 U 6/2012  
 CN 301956120 S 6/2012  
 CN 204071021 U 1/2015  
 CN 303593067 S 2/2016  
 CN 303722882 S 6/2016  
 CN 304272841 S 9/2017  
 CN 304701695 S \* 6/2018  
 DE 4317983 A 12/1994  
 DK MR-1992 00605 6/1992  
 EM 000287032-0003 3/2005  
 EM 000638028-0001 1/2007  
 EM 005227899-0002 4/2018  
 EP 1607021 A 12/2005  
 JP D1259839 1/2006  
 JP 1537381 S 11/2015  
 JP D1559412 9/2016  
 JP D1592525 12/2017  
 KR 300293393 S 3/2002  
 KR 300531343 S 6/2009  
 KR 2020170003690 U 10/2017  
 KR 2020170003692 U 10/2017  
 MX 035066 1/2011  
 MX 049087 8/2015  
 WO D065698-0006 3/2004  
 WO 2010069919 A1 6/2010  
 WO 2011084116 A1 7/2011  
 WO 2014197292 A1 12/2014  
 WO 2015042316 A1 3/2015  
 WO WO-2015/042316 A1 \* 3/2015  
 WO 2019119344 A 6/2019  
 WO WO-2019/119344 A1 \* 6/2019

OTHER PUBLICATIONS

Office Action dated Apr. 29, 2020 in related U.S. Appl. No. 29/673,495, 6 pages.

\* cited by examiner

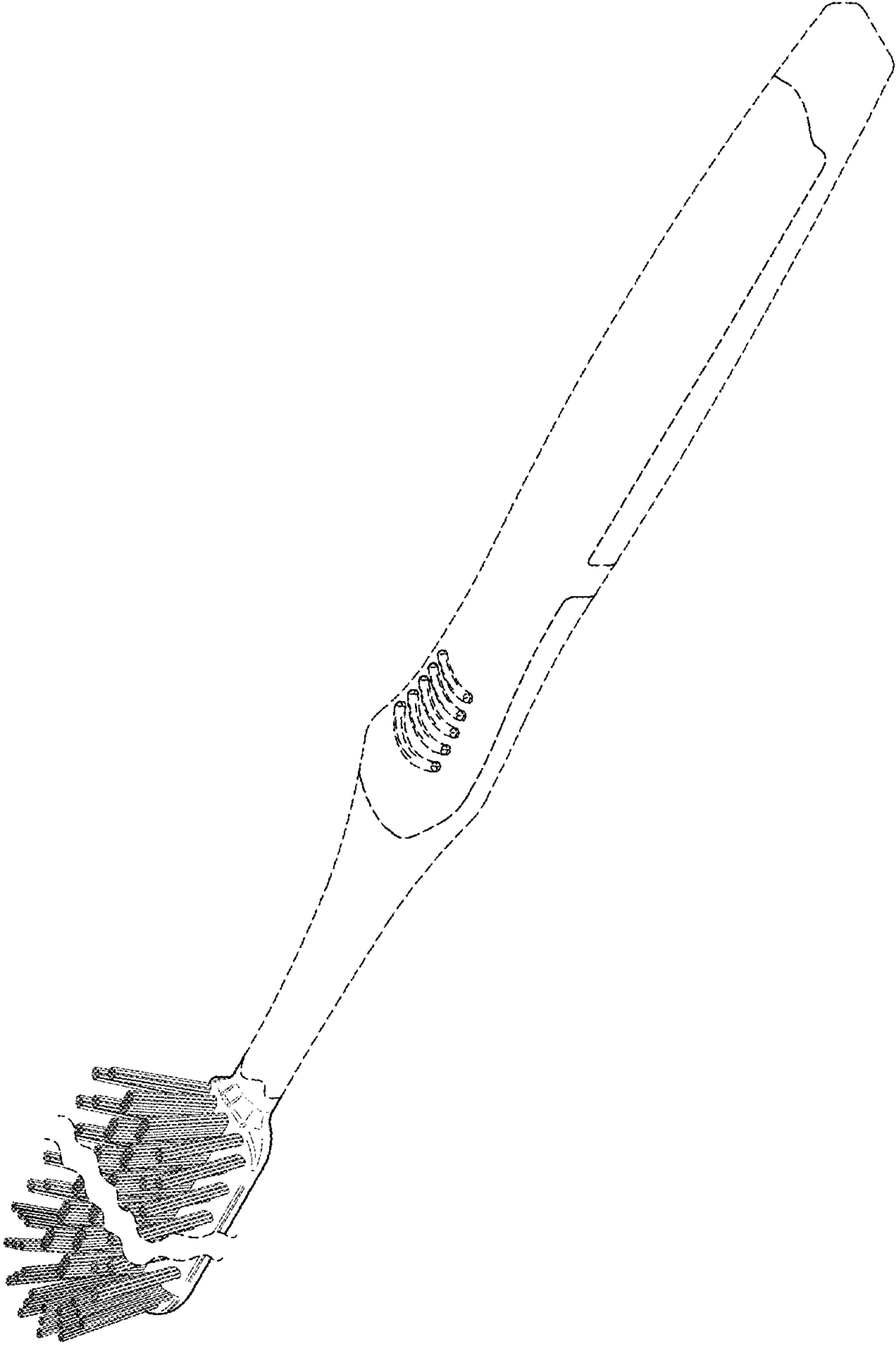

FIG. 1



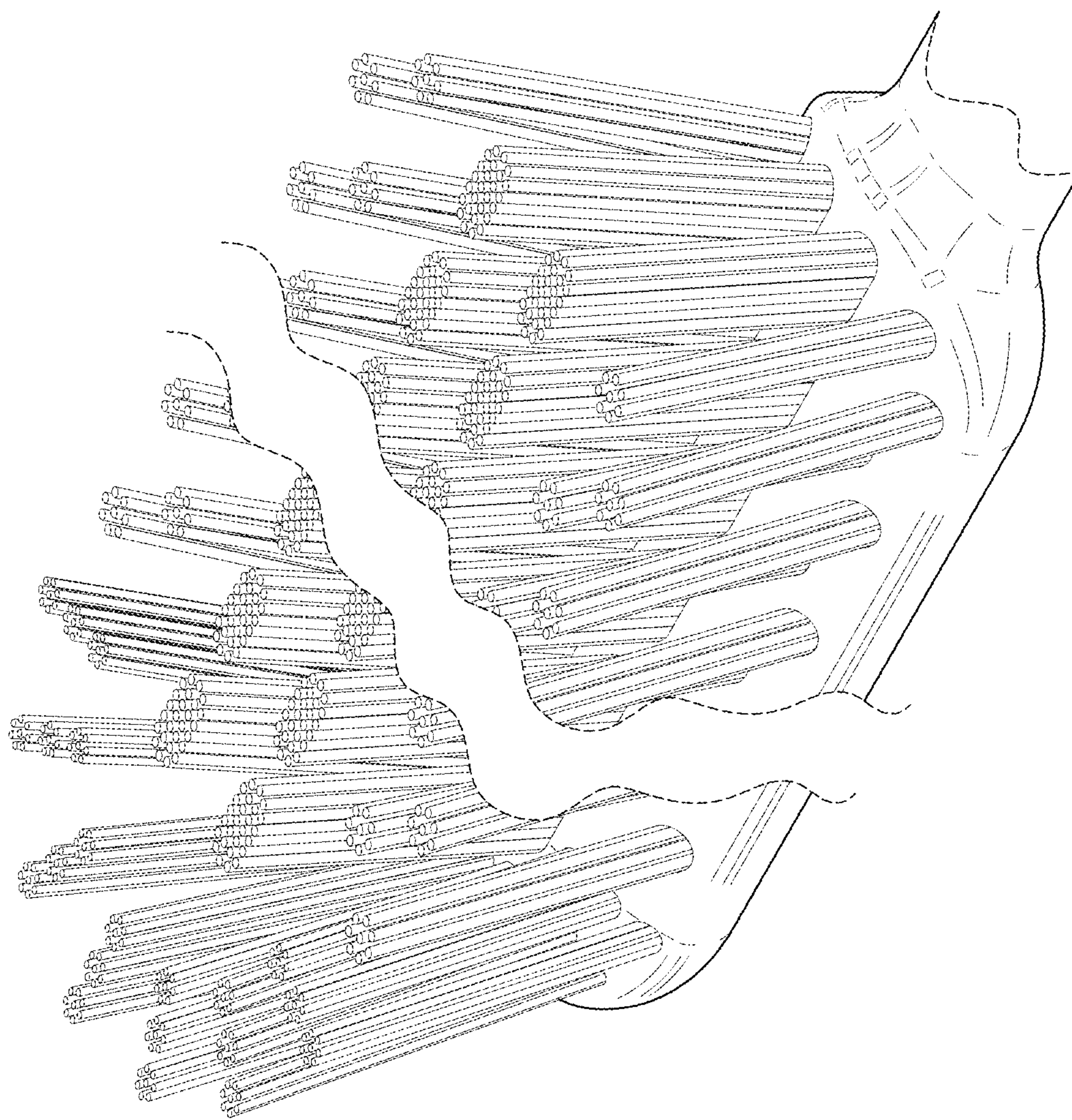
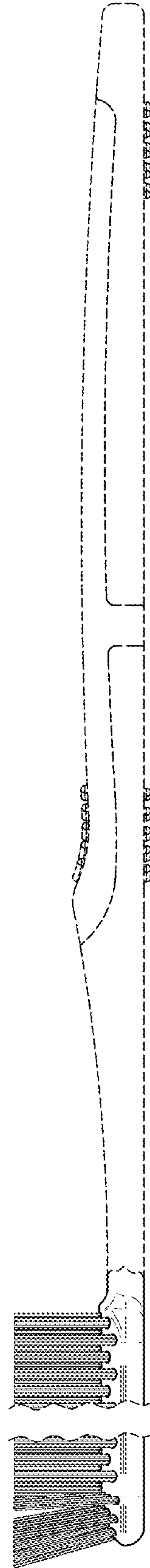

FIG. 2

FIG. 3



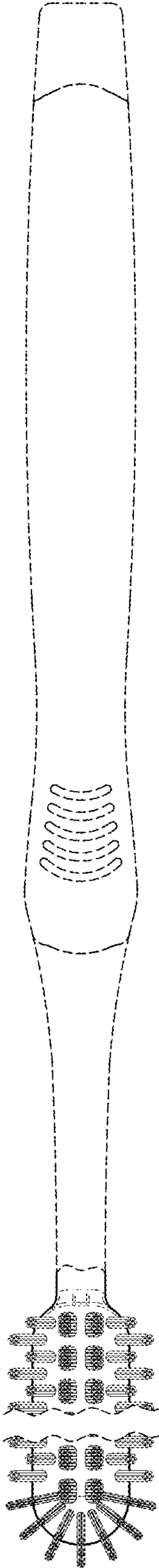

FIG. 4

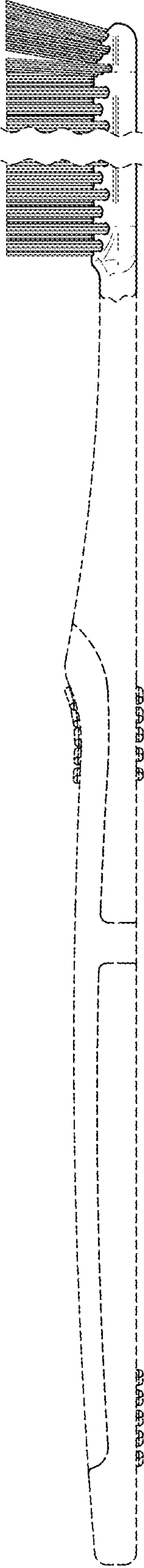

FIG. 5

FIG. 6

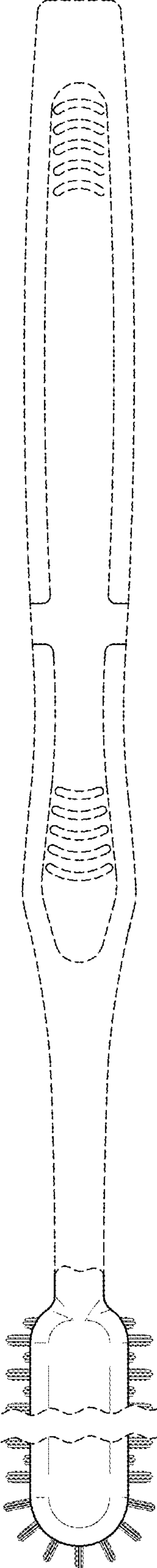



FIG. 7

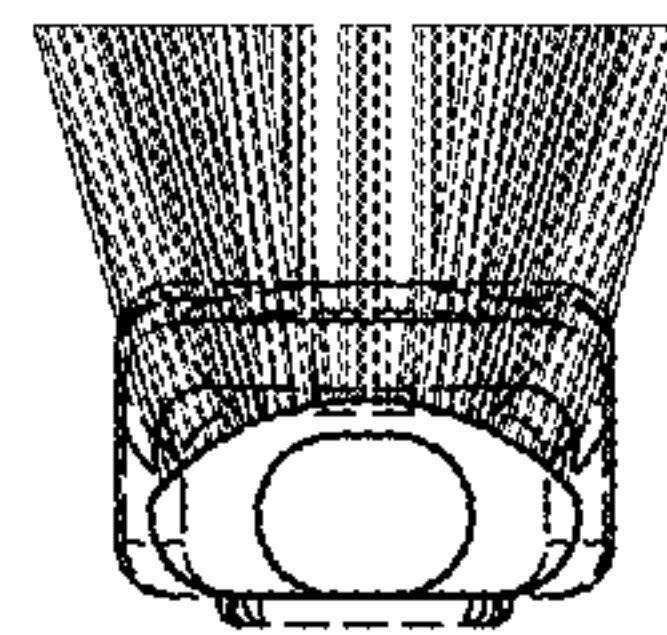
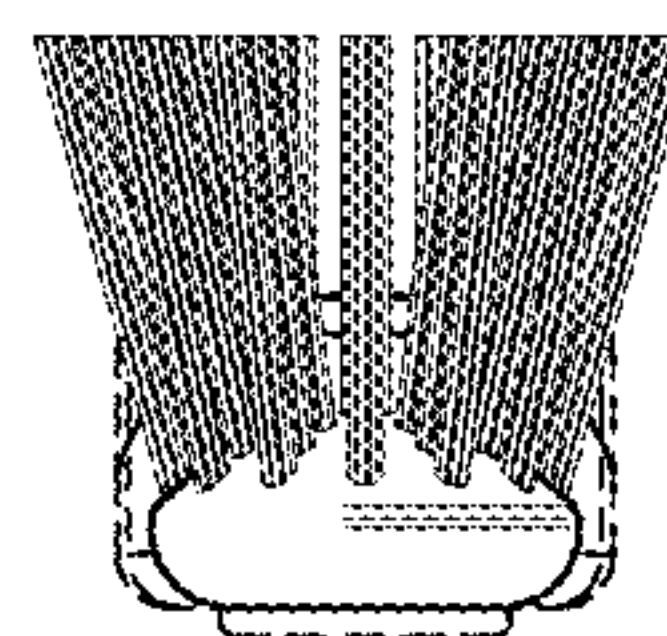

FIG. 8



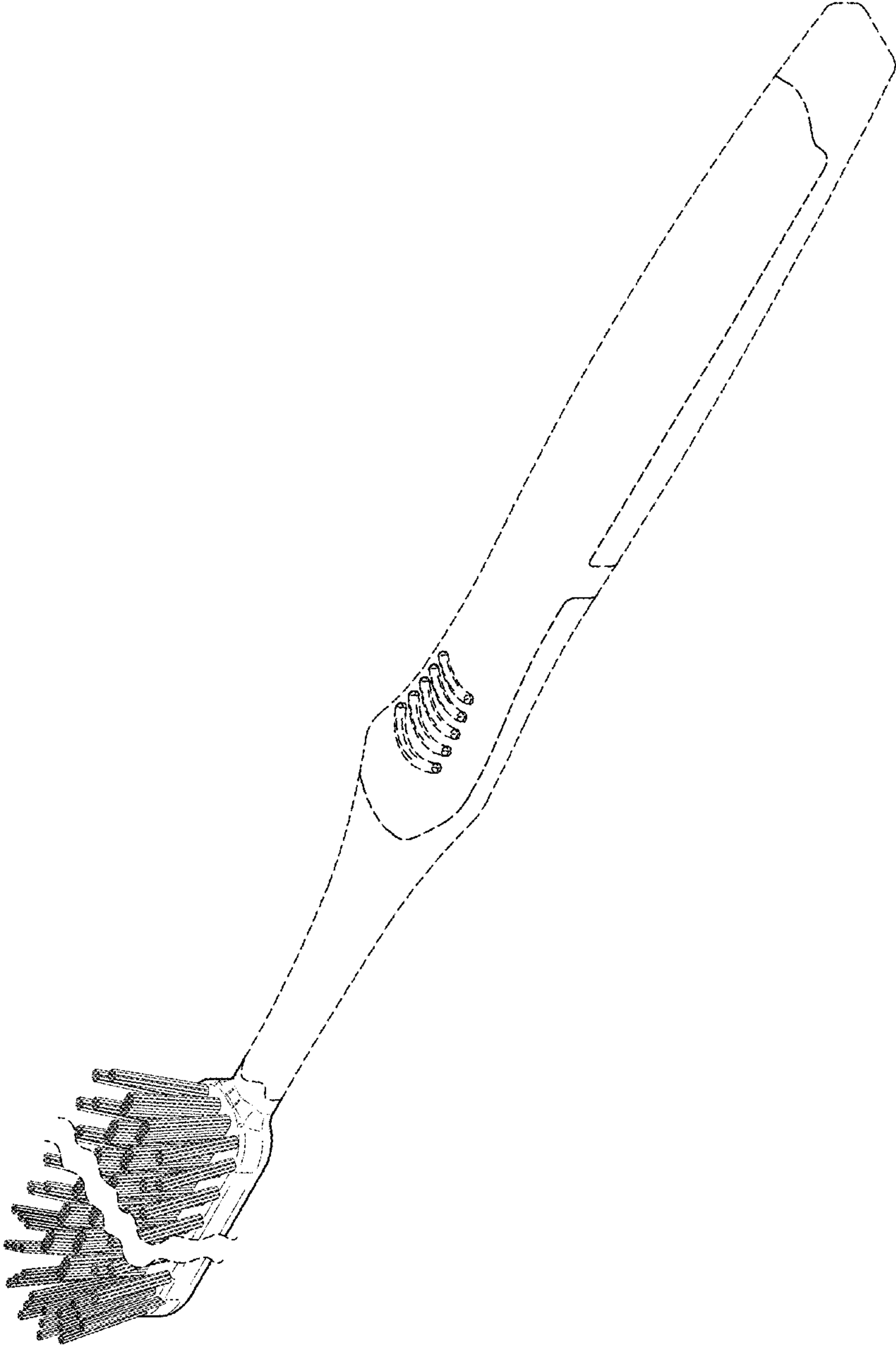

FIG. 9

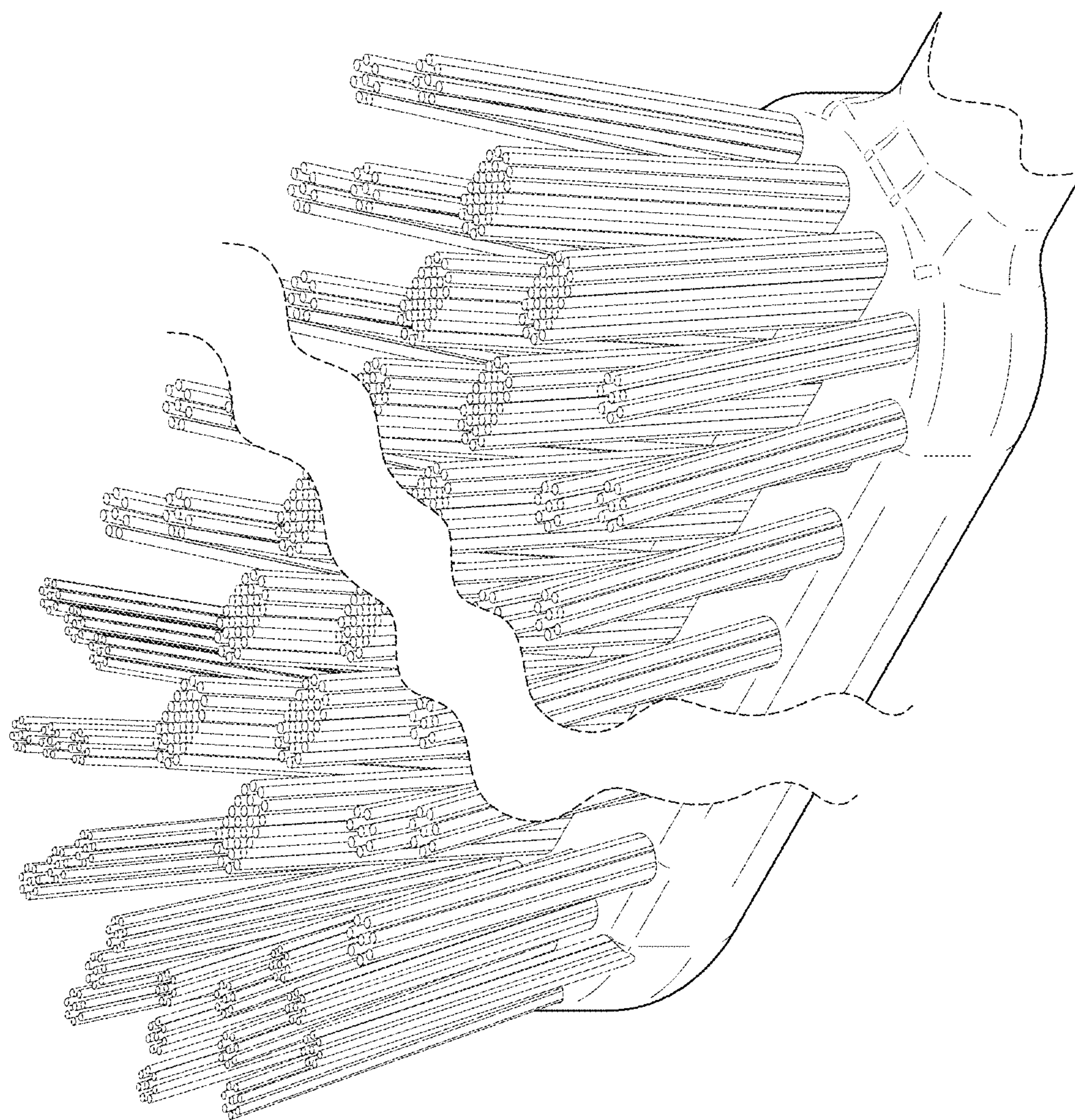

FIG. 10

FIG. 11

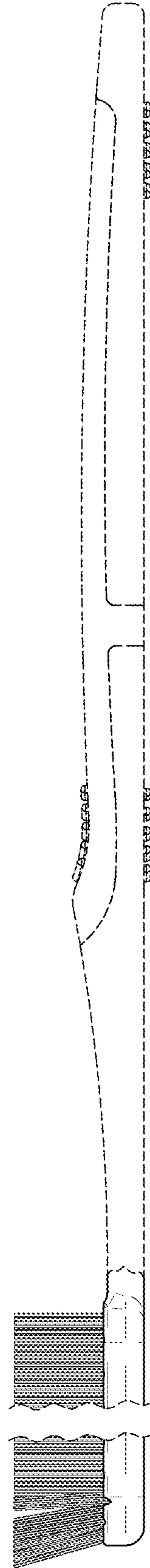



FIG. 12

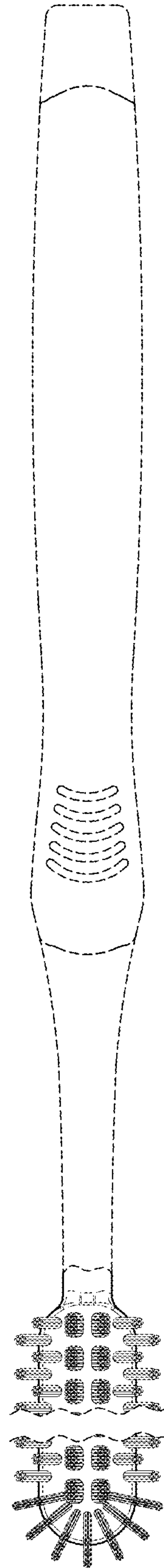

FIG. 13

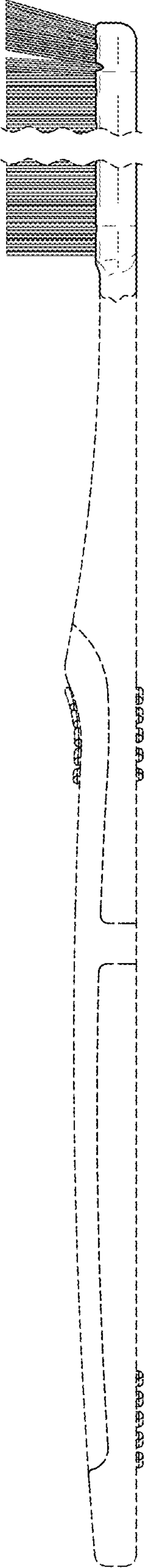

FIG. 14

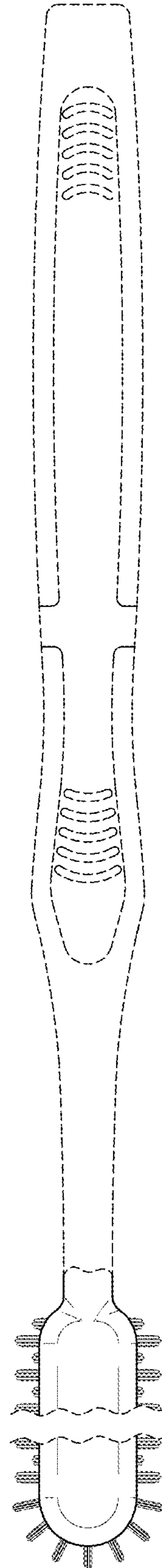

FIG. 15

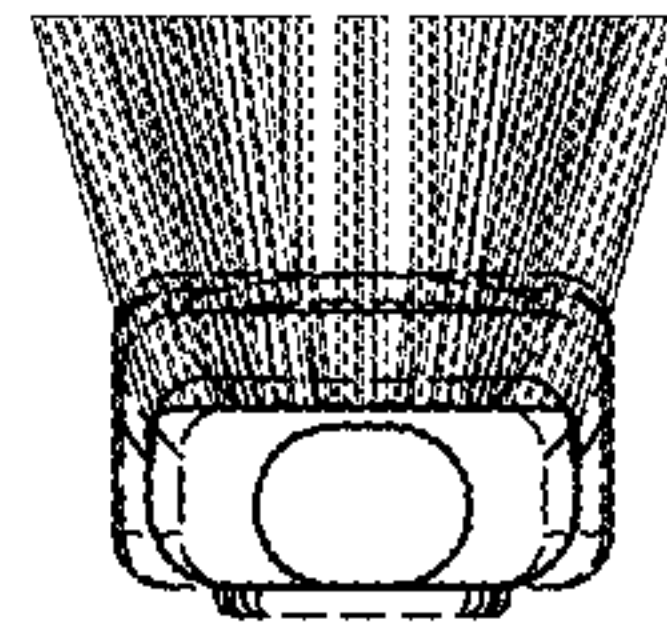

FIG. 16

