

US00D897677S

(12) **United States Design Patent** (10) **Patent No.:** **US D897,677 S**
Li (45) **Date of Patent:** **** Oct. 6, 2020**

(54) **GARMENT BAG**
(71) Applicant: **Jiangxi Banabo Trading Co., Ltd.**,
Nanchang (Jiangxi Province) (CN)
(72) Inventor: **Canghuan Li**, Nanchang (CN)
(73) Assignee: **Jiangxi Banabo Trading Co., Ltd.**,
Nanchang (CN)

D505,547 S * 5/2005 Whipple D3/278
D633,715 S * 3/2011 Berglund D3/278
D685,590 S * 7/2013 Hale D3/278
D687,633 S * 8/2013 Deutschendorf D3/278
D812,376 S * 3/2018 Cogan D3/278
2010/0224515 A1* 9/2010 Siegel A45C 3/001
206/279
2011/0168584 A1* 7/2011 Torrellas A45C 3/004
206/287
2015/0289619 A1* 10/2015 Cogan A45C 3/004
190/109

(**) Term: **15 Years**

(21) Appl. No.: **29/653,919**

(22) Filed: **Jun. 19, 2018**

(51) **LOC (12) Cl.** **03-01**

(52) **U.S. Cl.**

USPC **D3/278**

(58) **Field of Classification Search**

USPC D3/203.6, 205, 273, 274, 275, 276, 278,
D3/283, 284, 287, 289, 294, 297, 296,
D3/299, 302, 303, 901, 903, 905, 301,
D3/298

CPC .. A45D 2033/001; A45D 33/00; A45D 44/18;
A45C 11/16; A45C 3/004; A45C
2003/008; A45C 5/005; A45C 2011/002;
A45C 15/04; A45C 2200/10

See application file for complete search history.

(56) **References Cited**

U.S. PATENT DOCUMENTS

D241,986 S * 10/1976 Pelavin D3/278
D265,607 S * 8/1982 Cooper D3/278
D281,547 S * 12/1985 Bomes D3/278
D281,651 S * 12/1985 Bomes D3/278
D283,373 S * 4/1986 Bomes D3/278
4,817,791 A * 4/1989 Adams A45C 3/004
206/287.1
D385,419 S * 10/1997 Ibigbami D3/278
D479,400 S * 9/2003 Clymer D3/278
D499,548 S * 12/2004 Deutschendorf D3/278

OTHER PUBLICATIONS

Amazon, "MISSLO Breathable 40" Costume Garment Bag . . . ",
First reviewed May 4, 2018. (<https://www.amazon.com/MISSLO-Breathable-Costume-Garment-Accessories/dp/B07C1G1D5J/>) (Year:
2018).*

* cited by examiner

Primary Examiner — April Rivas

(74) *Attorney, Agent, or Firm* — Yong Chen

(57) **CLAIM**

The ornamental design for a garment bag, as shown and
described.

DESCRIPTION

FIG. 1 is a front view of a garment bag of the present
invention.

FIG. 2 is a back view thereof.

FIG. 3 is a top view thereof.

FIG. 4 is a bottom view thereof.

FIG. 5 is a left view thereof.

FIG. 6 is a right view thereof.

FIG. 7 is a front perspective view thereof; and,

FIG. 8 is a back perspective view thereof.

The broken lines illustrate portions of the garment bag and
form no part of the claimed design.

1 Claim, 8 Drawing Sheets

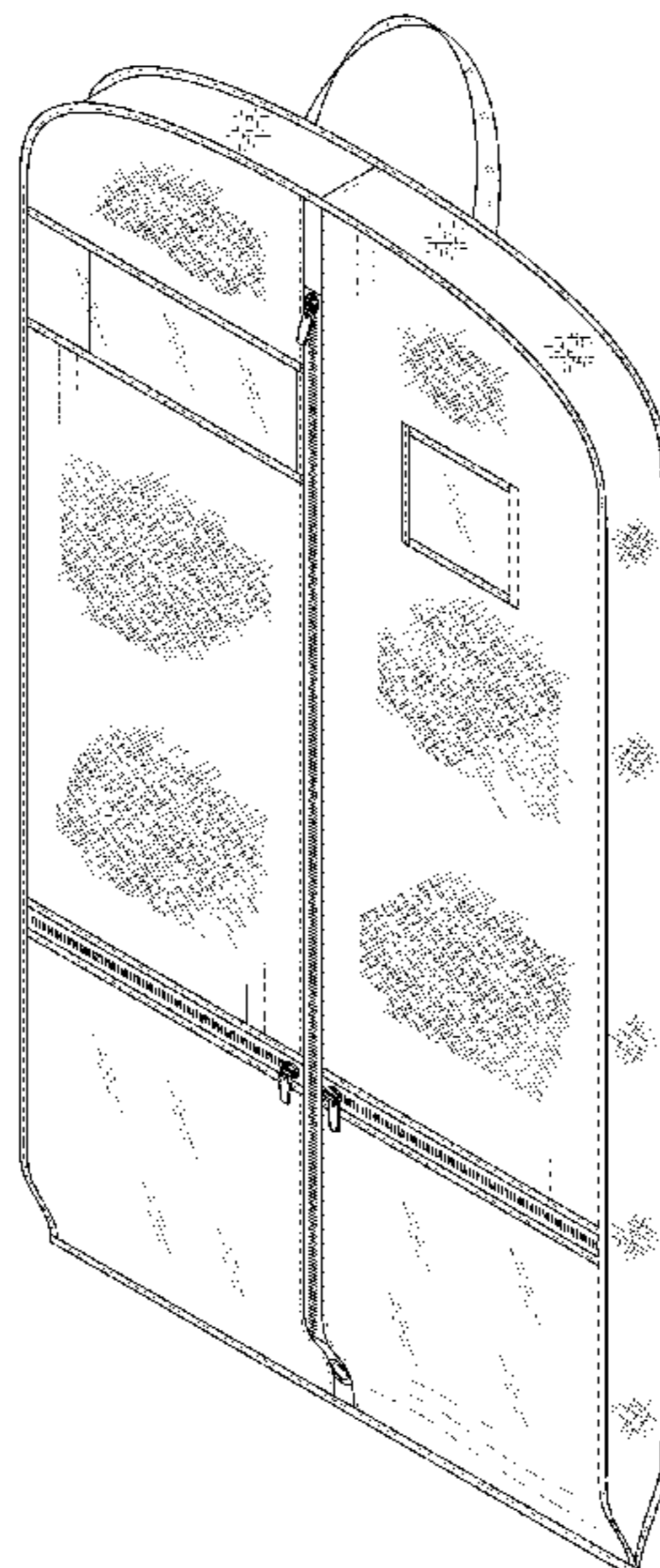

FIG. 1

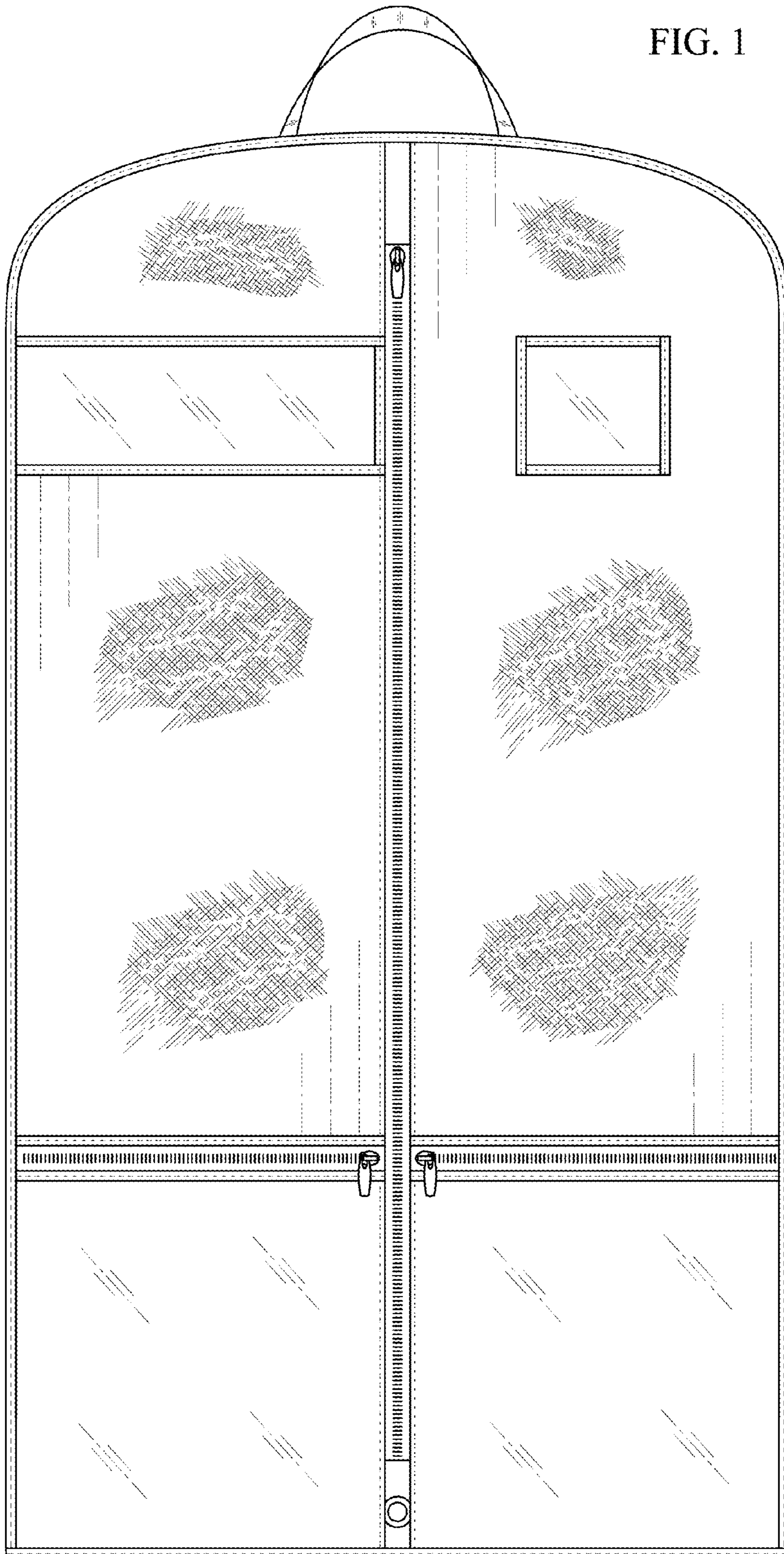
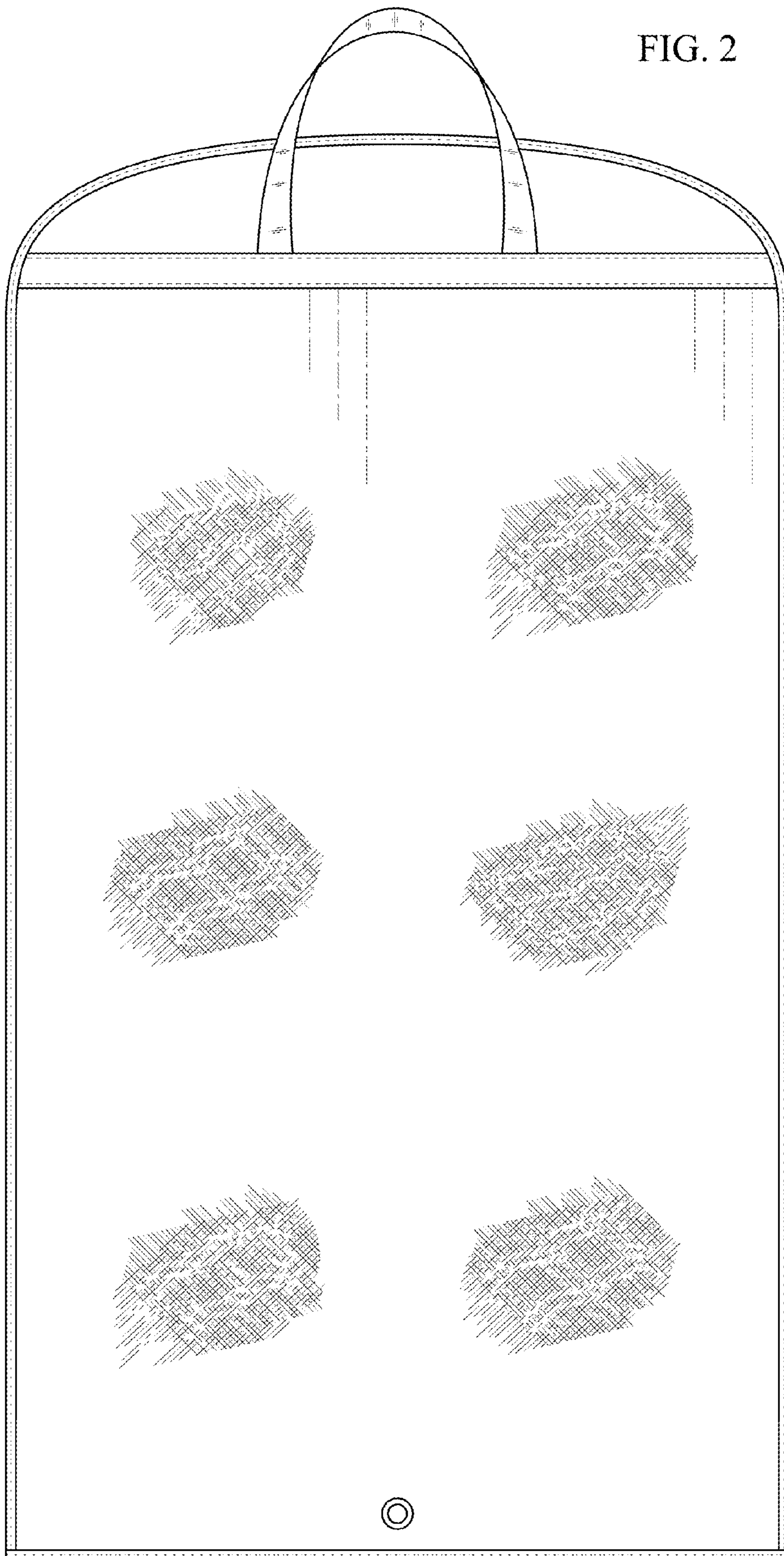

FIG. 2



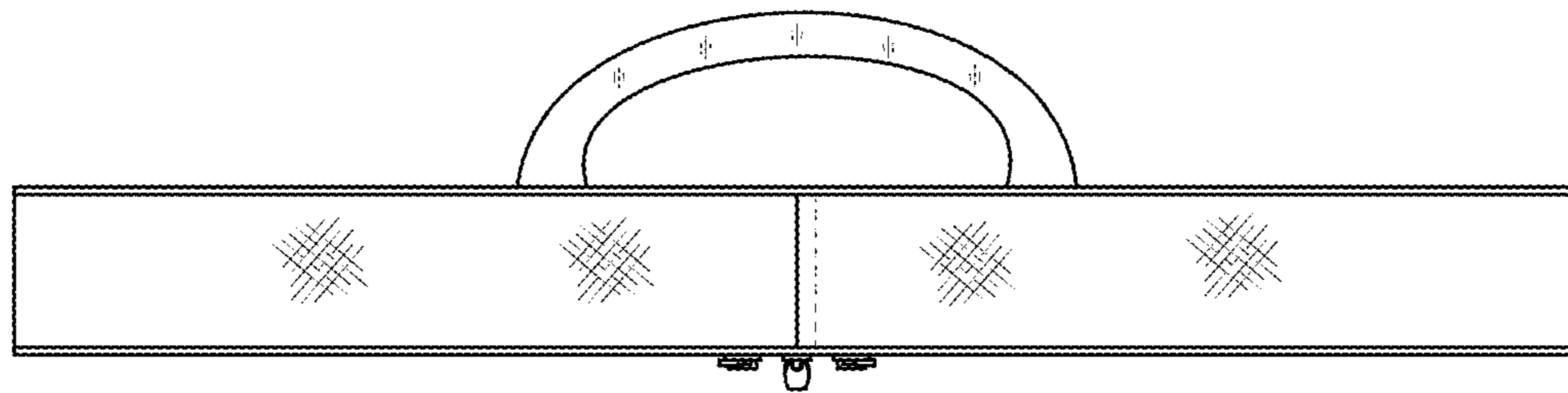

FIG. 3

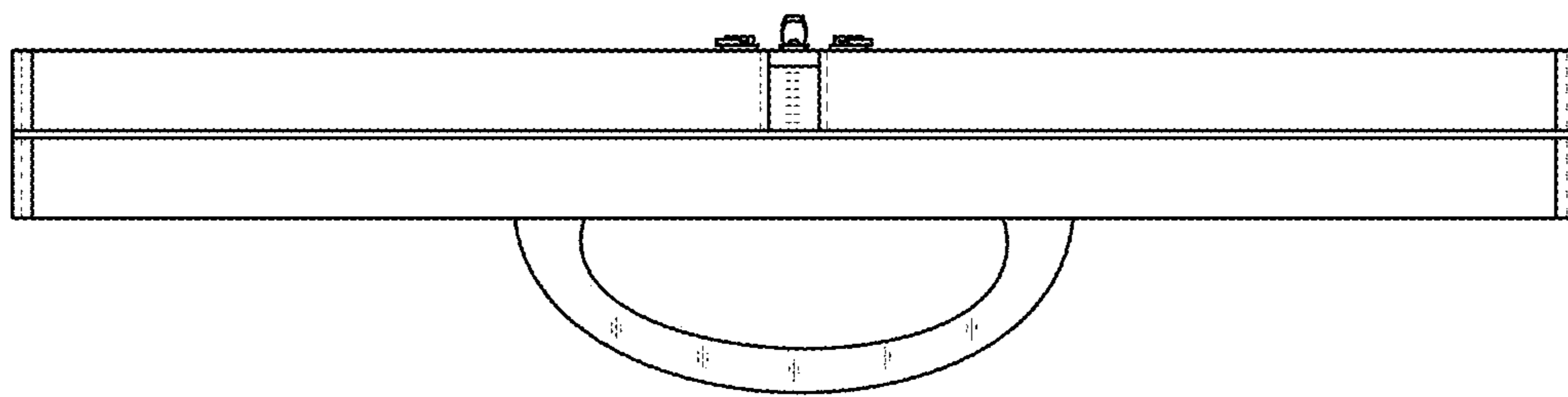

FIG. 4

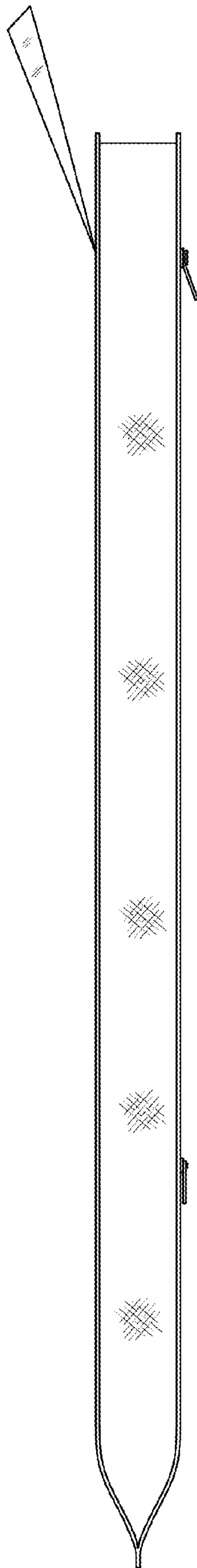

FIG. 5

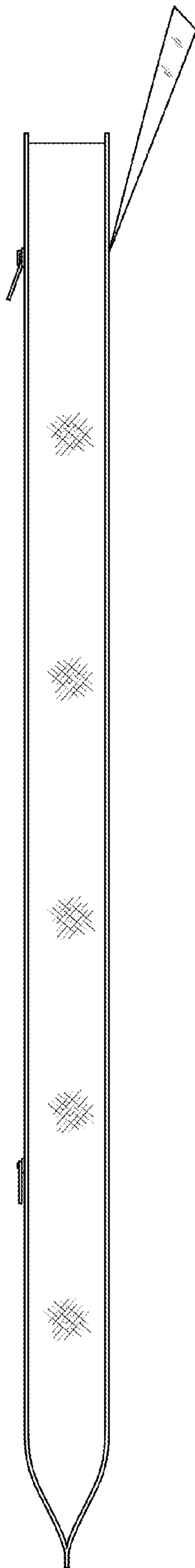

FIG. 6

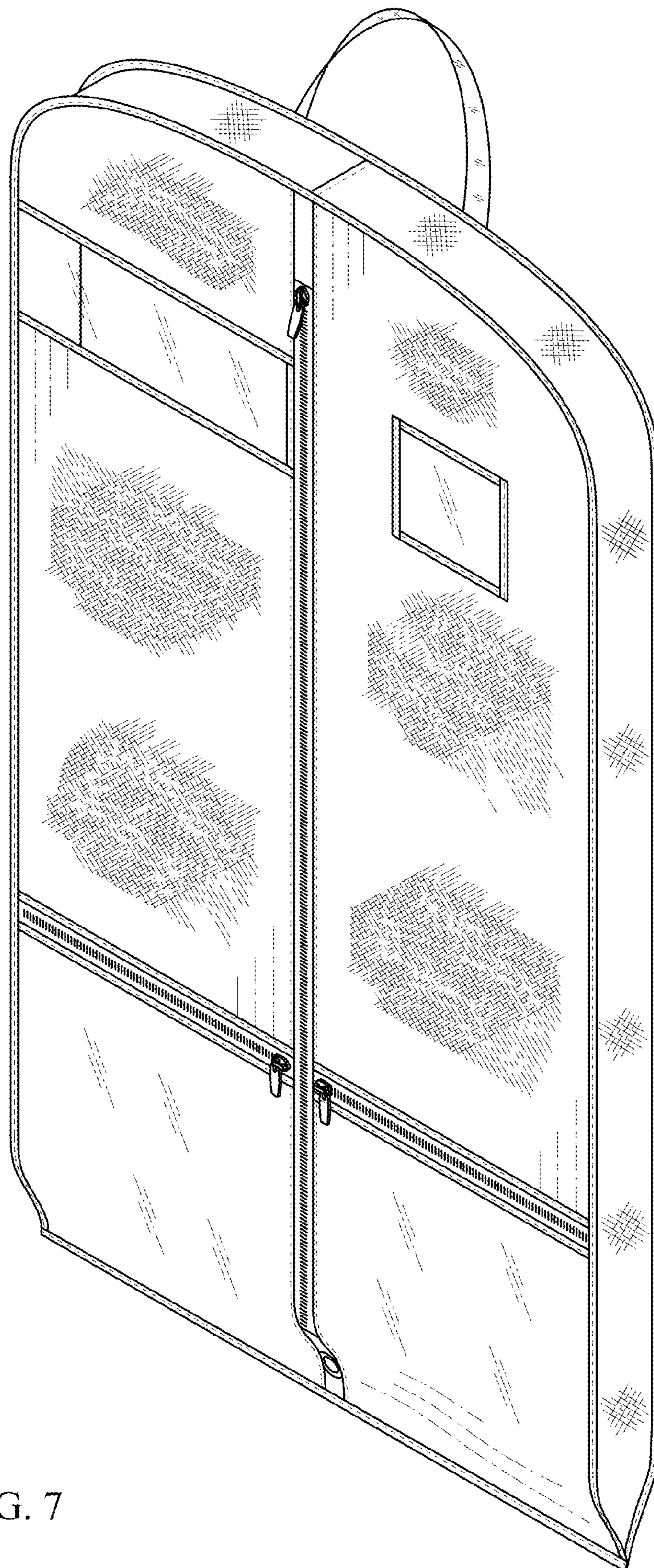

FIG. 7

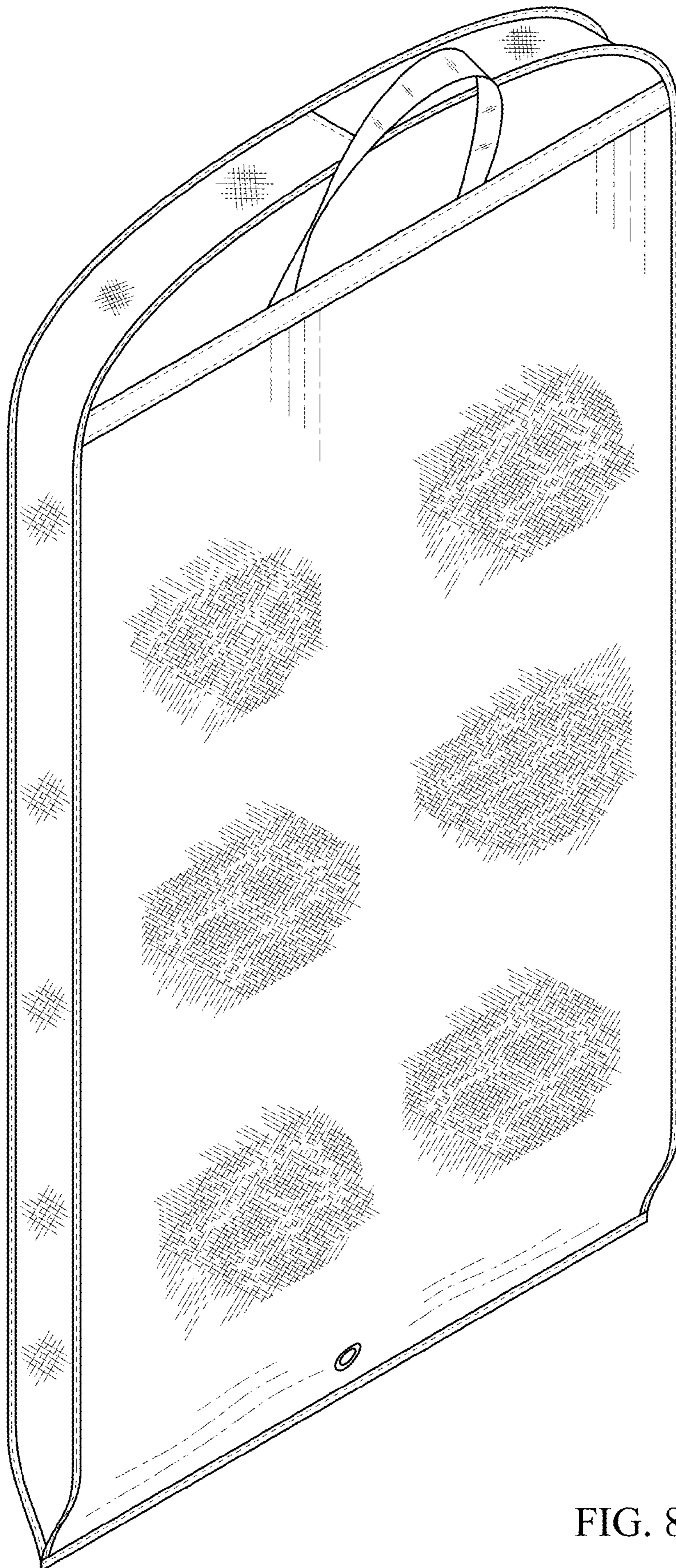

FIG. 8