

US00D897641S

(12) **United States Design Patent**  
**Martin**

(10) **Patent No.:** **US D897,641 S**

(45) **Date of Patent:** **\*\* Oct. 6, 2020**

(54) **SHOE**

(71) Applicant: **NIKE, Inc.**, Beaverton, OR (US)

(72) Inventor: **Angela N. Martin**, Lake Oswego, OR (US)

(73) Assignee: **NIKE, Inc.**, Beaverton, OR (US)

(\*\*) Term: **15 Years**

(21) Appl. No.: **29/683,801**

(22) Filed: **Mar. 15, 2019**

(51) **LOC (12) Cl.** ..... **02-04**

(52) **U.S. Cl.**  
USPC ..... **D2/902**

(58) **Field of Classification Search**  
USPC ..... D2/902, 907, 908, 910, 944, 945, 946,  
D2/969, 970, 971, 972, 973, 974, 975,  
D2/976  
CPC ..... A43B 3/14; A43B 3/0084; A43B 5/001;  
A43B 13/223; A43B 5/00; A43C 9/02;  
A43C 11/24  
See application file for complete search history.

(56) **References Cited**

U.S. PATENT DOCUMENTS

D367,162 S *	2/1996	Shea	.....	D2/908
D575,043 S *	8/2008	Hatfield	.....	D2/969
D696,847 S	1/2014	McCullagh		
D715,040 S	10/2014	Mermet		
D738,092 S	9/2015	Caron		

D863,752 S *	10/2019	Taneva	.....	D2/972
D865,345 S *	11/2019	Taneva	.....	D2/971
D869,143 S *	12/2019	de Montgolfier	.....	D2/972
D869,144 S *	12/2019	de Montgolfier	.....	D2/973
D871,746 S *	1/2020	Cin	.....	D2/973
D871,747 S *	1/2020	de Montgolfier	.....	D2/973
D878,735 S *	3/2020	Engel	.....	D2/973
D882,909 S *	5/2020	Small	.....	D2/902

\* cited by examiner

*Primary Examiner* — Kevin K Rudzinski

*Assistant Examiner* — Amber J Rabie

(74) *Attorney, Agent, or Firm* — Banner & Witcoff, Ltd.

(57) **CLAIM**

The ornamental design for a shoe, as shown and described.

**DESCRIPTION**

FIG. 1 is a front perspective view of a shoe showing my new design;  
FIG. 2 is a side view thereof;  
FIG. 3 is a rear perspective view thereof;  
FIG. 4 is rear view thereof;  
FIG. 5 is a second rear perspective view thereof;  
FIG. 6 is an opposite side view thereof; and,  
FIG. 7 is a second front perspective view thereof.  
The broken lines showing the lacing elements and openings therefor represent unclaimed subject matter. The broken line immediately adjacent to the rear bottom edge of the shaded area defines the bounds of the claimed design and forms no part thereof. The broken lines depicting the remainder of the shoe show features that form no part of the claimed design.

**1 Claim, 7 Drawing Sheets**

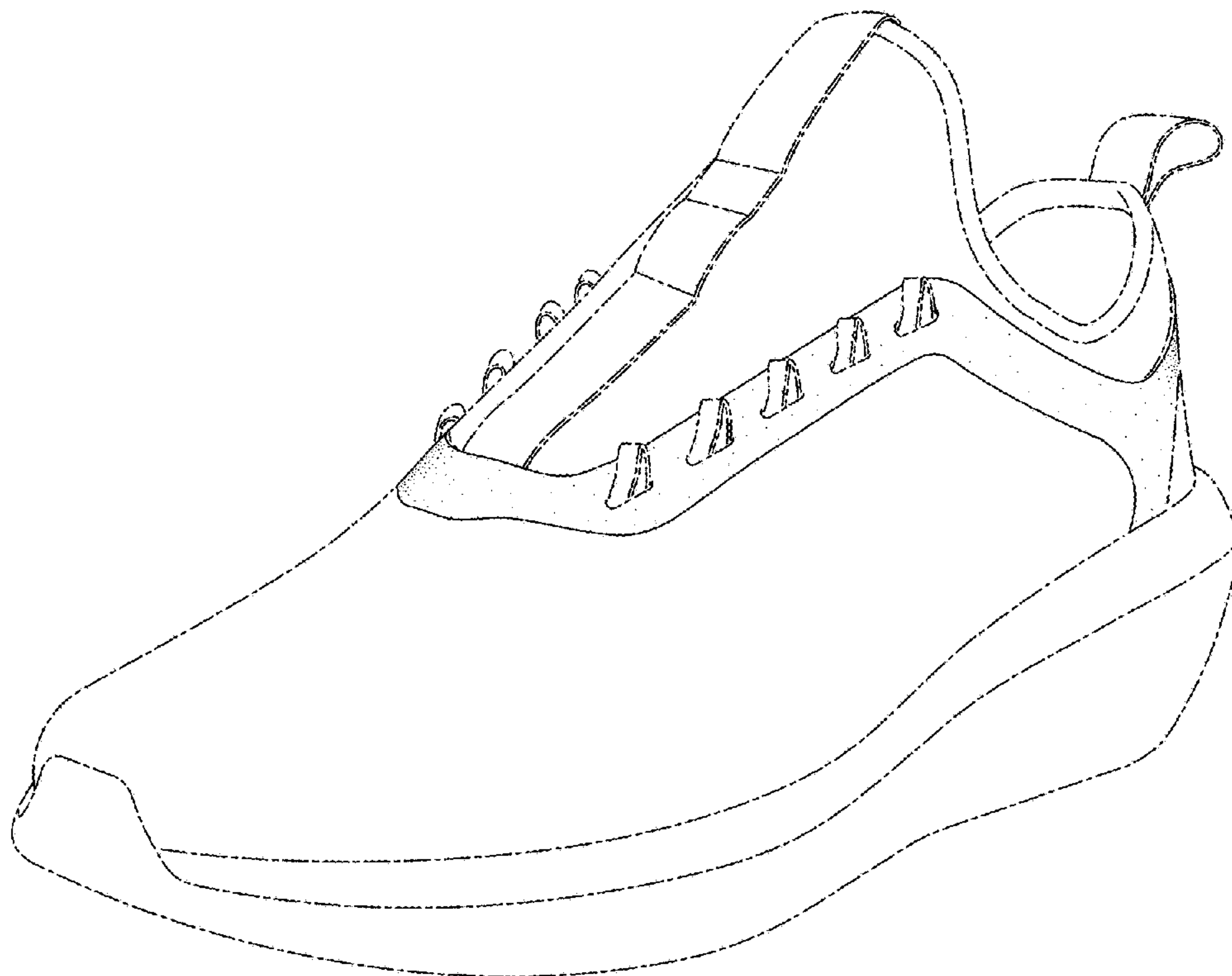

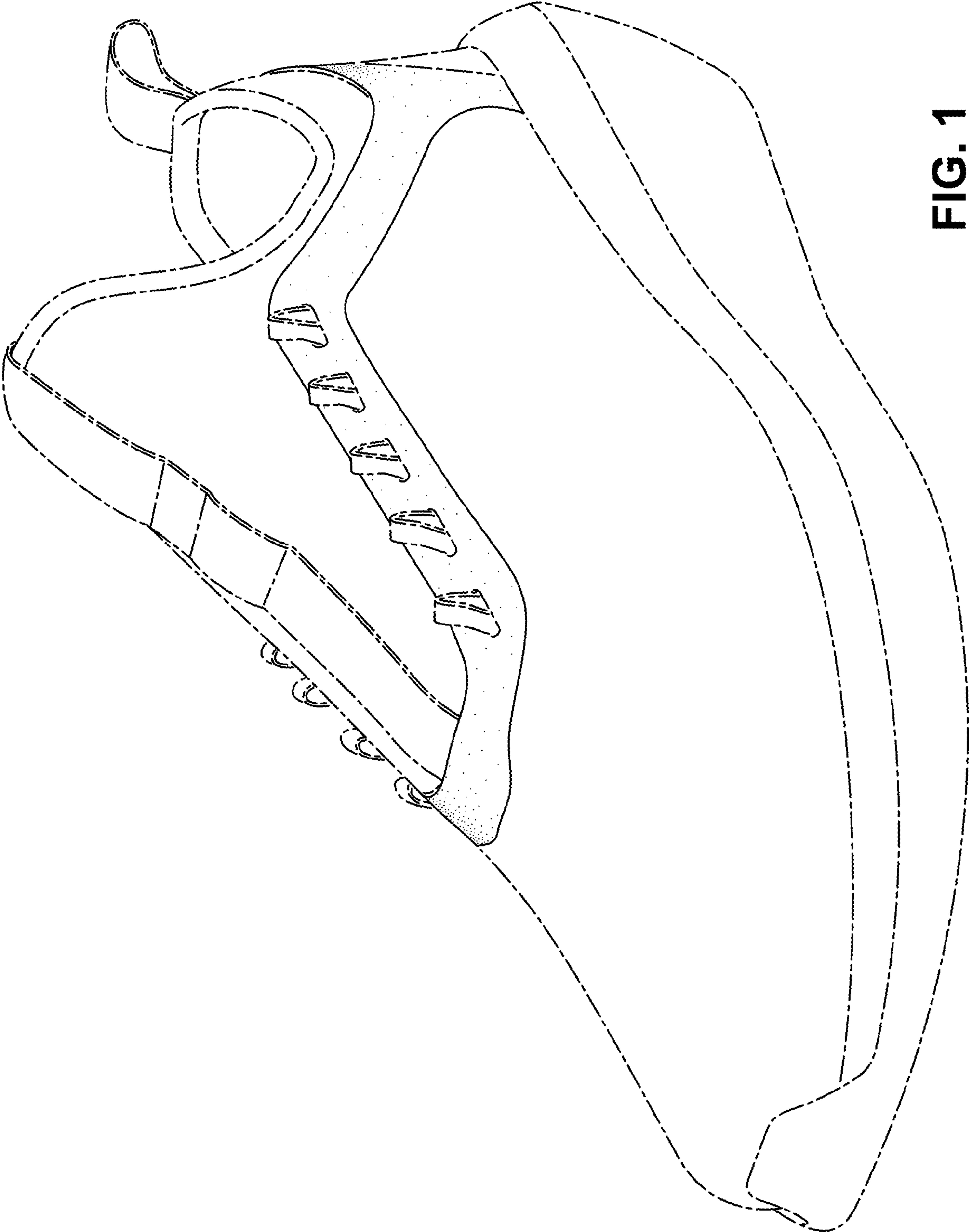

FIG. 1

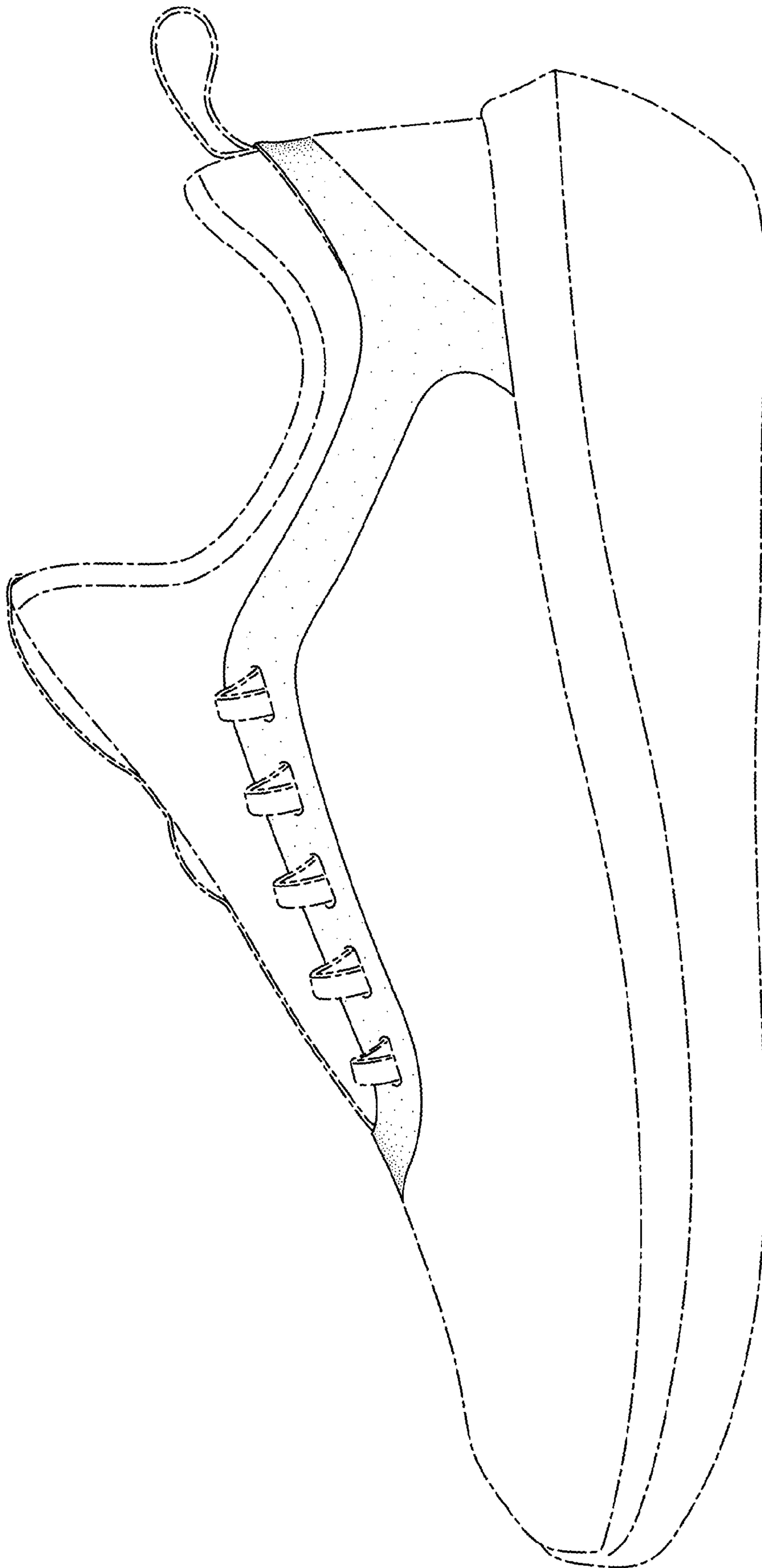

FIG. 2

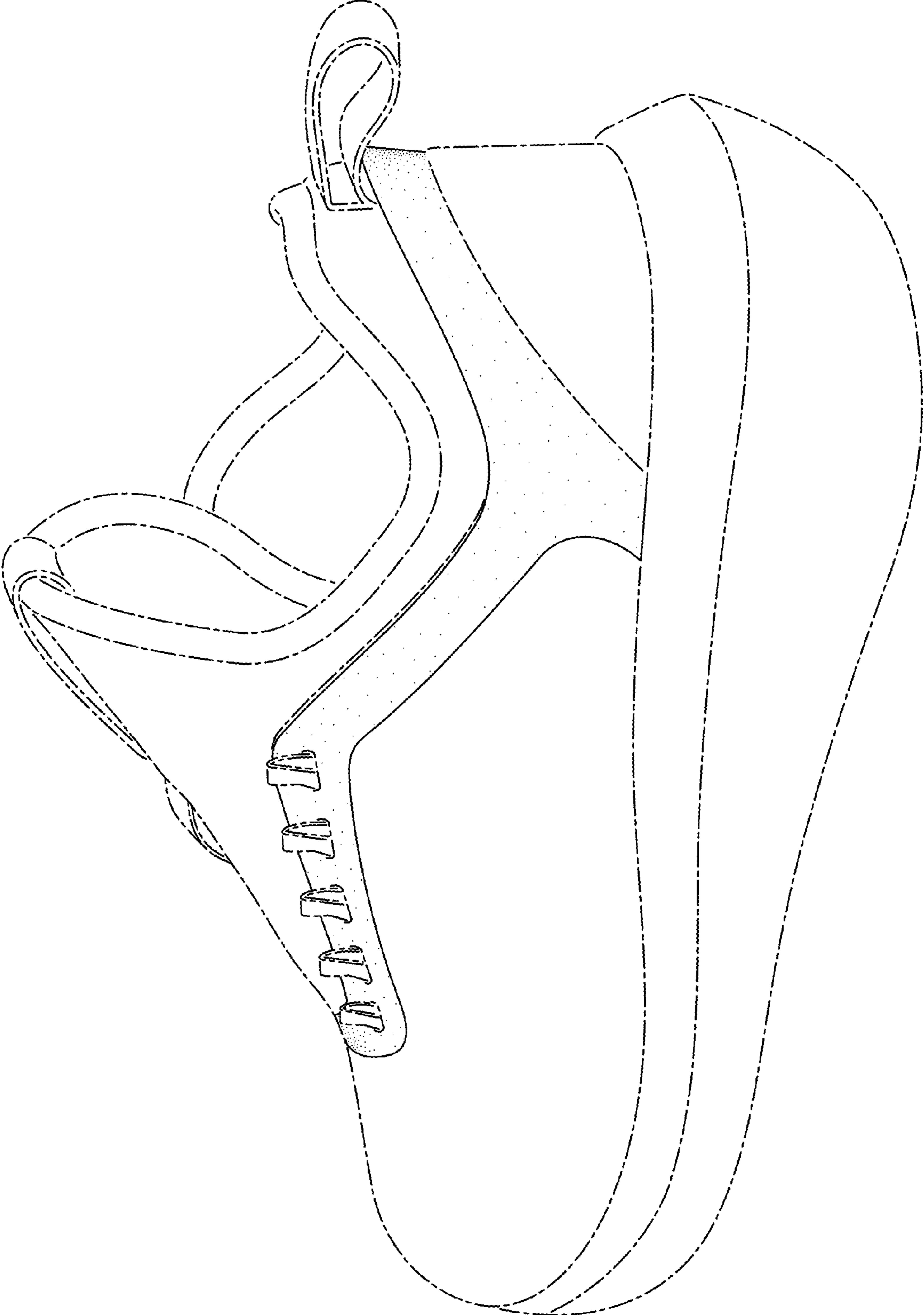
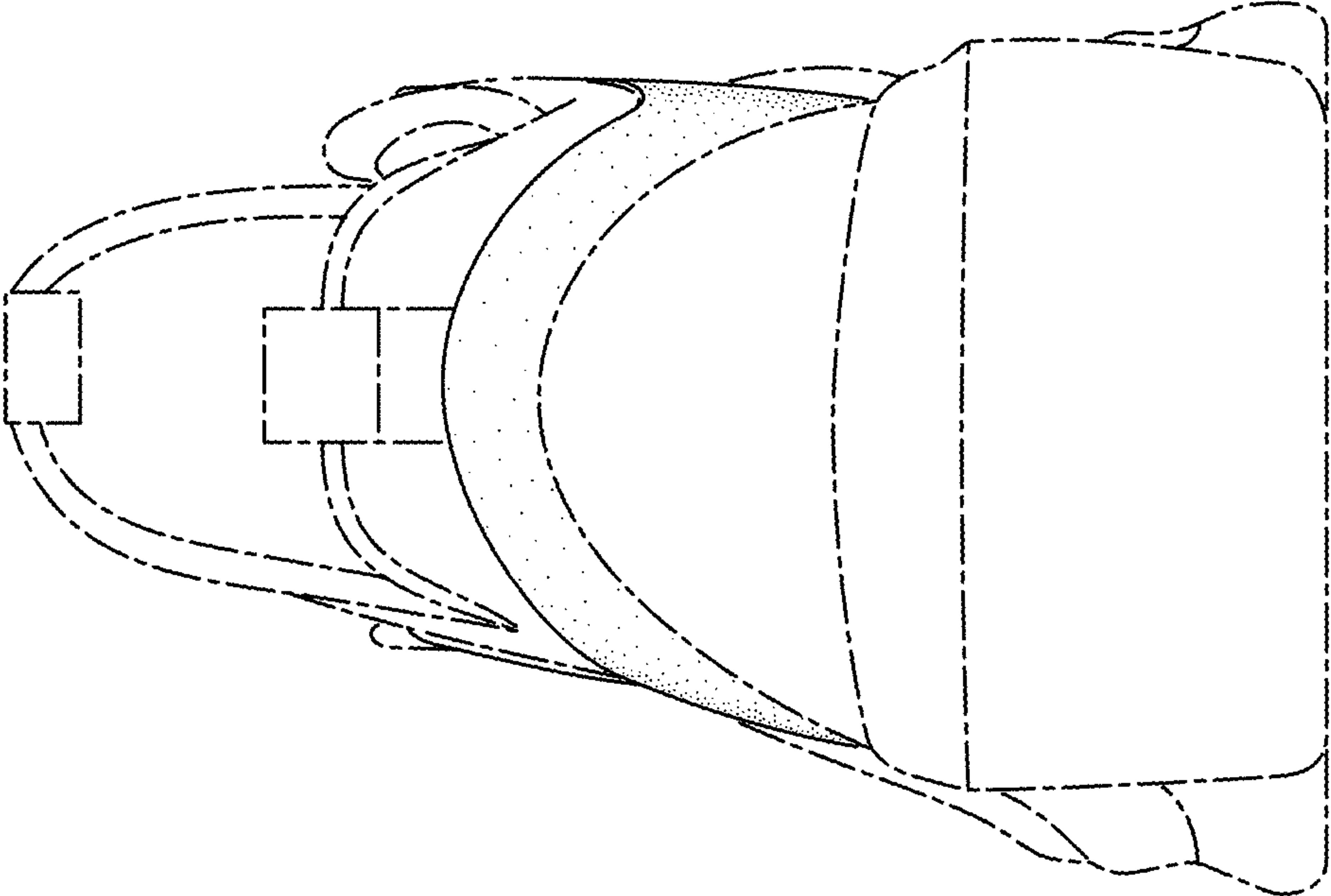

FIG. 3



**FIG. 4**



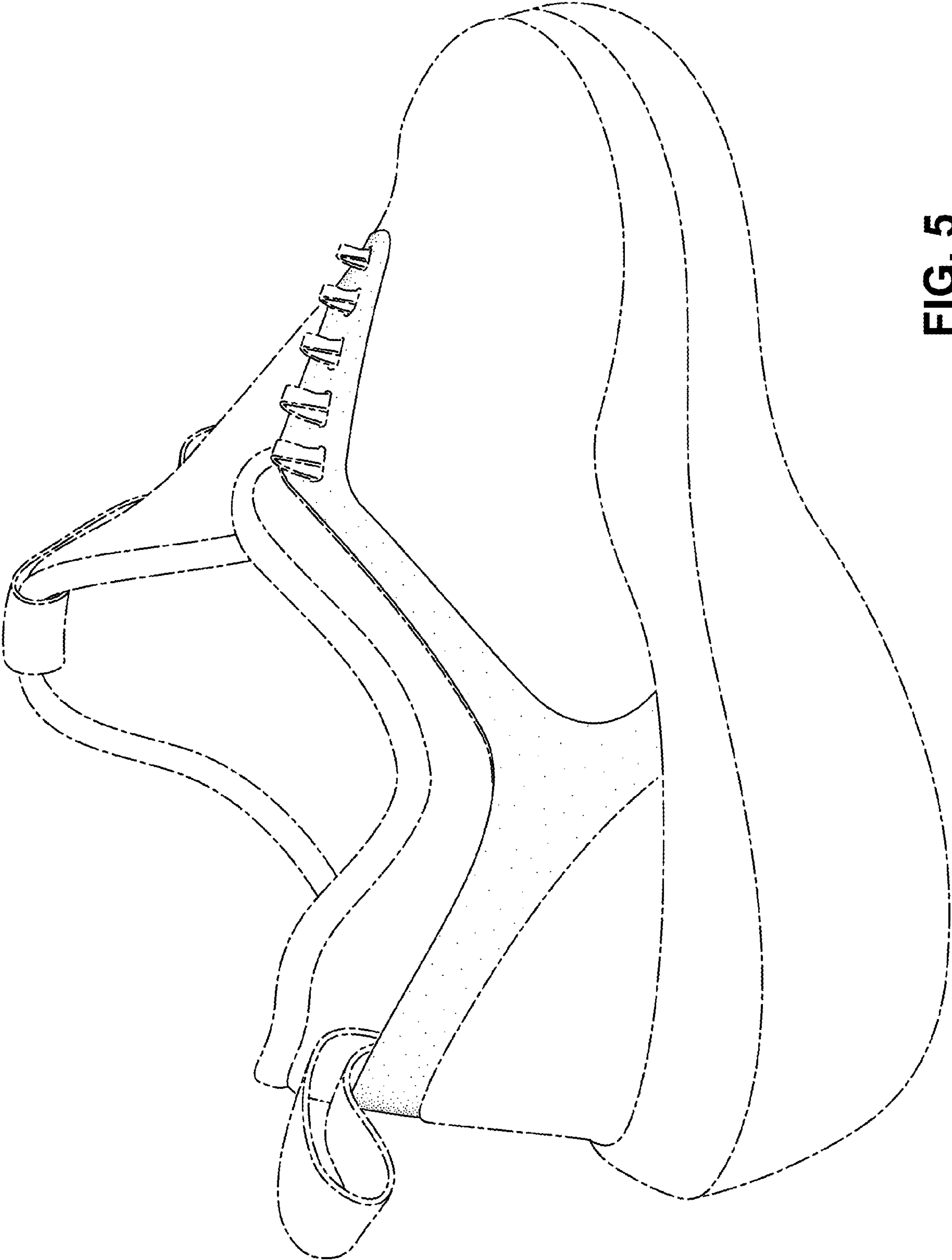

FIG. 5

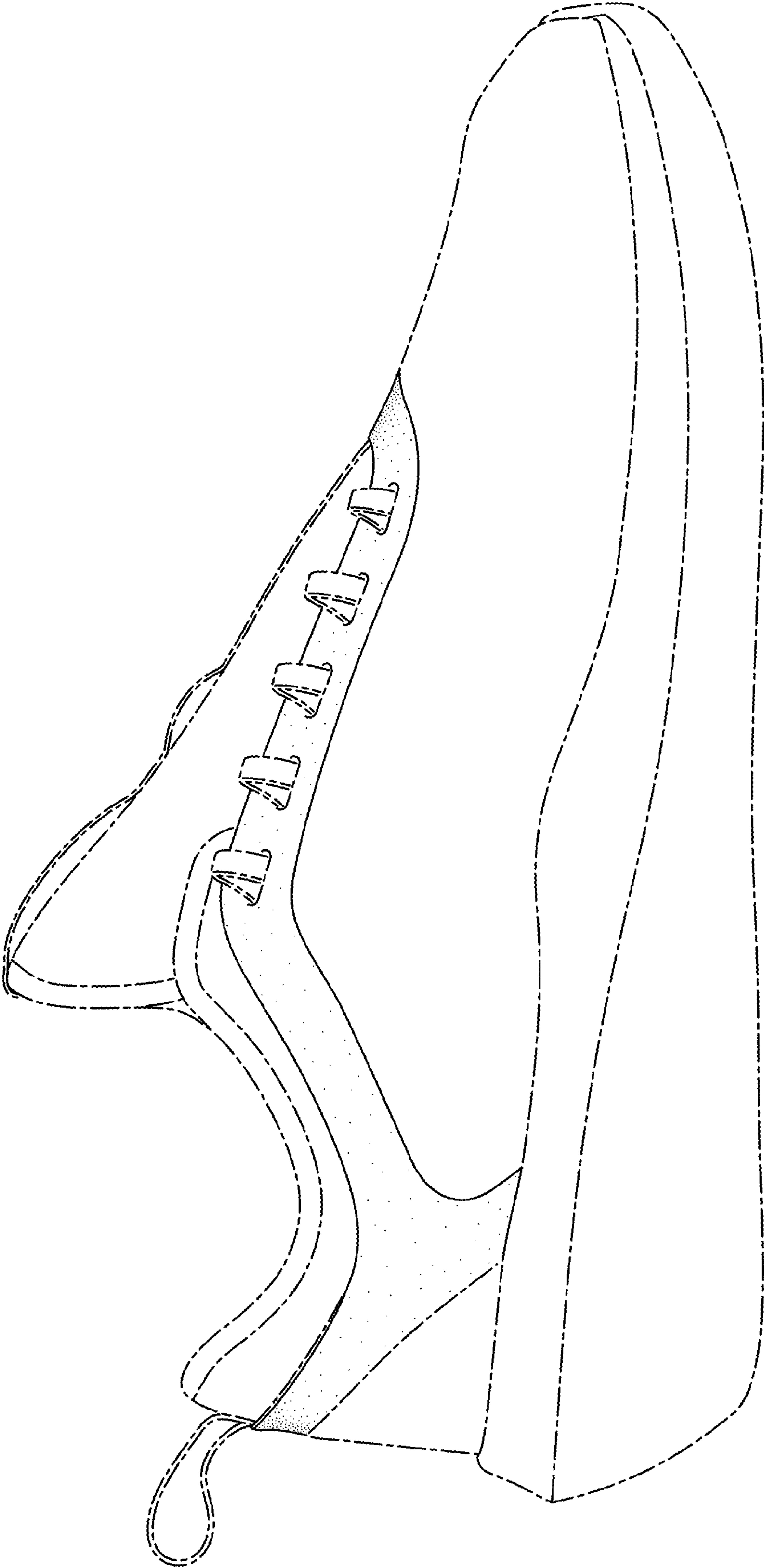

FIG. 6

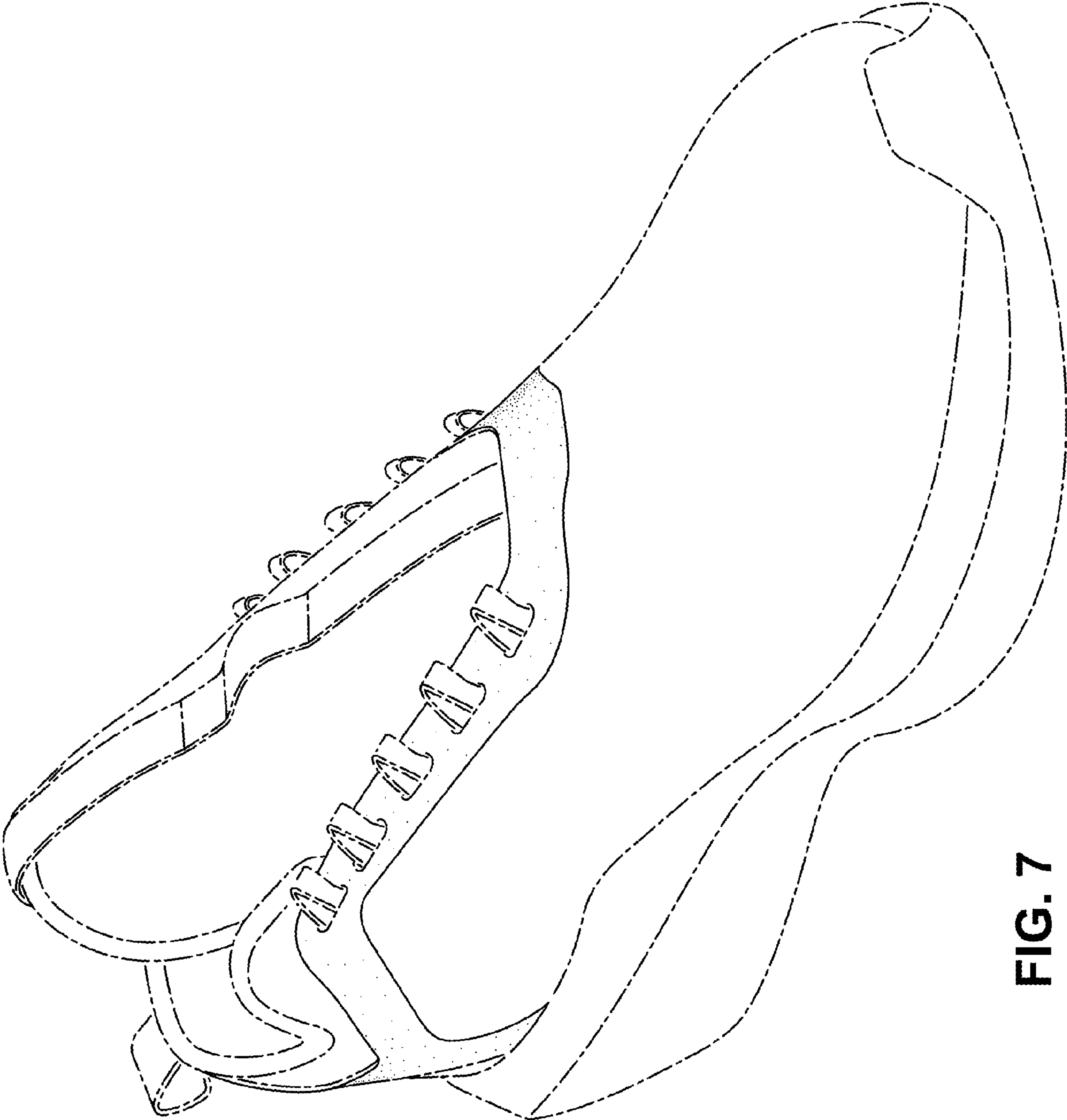

FIG. 7