



US00D897615S

(12) **United States Design Patent**  
**Nam et al.**

(10) **Patent No.:** **US D897,615 S**  
(45) **Date of Patent:** **\*\* Sep. 29, 2020**

(54) **RACK FOR DISHWASHER**

(71) Applicant: **LG ELECTRONICS INC.**, Seoul (KR)

(72) Inventors: **Bohyun Nam**, Seoul (KR); **Kyutae Park**, Seoul (KR); **Wonjun Lee**, Seoul (KR); **Seonil Yu**, Seoul (KR); **Jungkyu Son**, Seoul (KR)

(73) Assignee: **LG ELECTRONICS INC.**, Seoul (KR)

(\*\*) Term: **15 Years**

(21) Appl. No.: **35/507,546**

(22) Filed: **Mar. 13, 2019**

(80) **Hague Agreement Data**

Int. Filing Date: **Mar. 13, 2019**  
Int. Reg. No.: **DM/203510**  
Int. Reg. Date: **Mar. 13, 2019**  
Int. Reg. Pub. Date: **Oct. 25, 2019**

(30) **Foreign Application Priority Data**

Sep. 17, 2018 (KR) ..... 30-2018-0043498

(51) **LOC (12) Cl.** ..... **15-05**

(52) **U.S. Cl.**  
USPC ..... **D32/3**

(58) **Field of Classification Search**  
USPC ..... D32/2, 3, 25, 28  
CPC .... A47L 15/507; A47L 15/4257; A47L 15/22;  
A47L 15/23; A47L 15/4221; A47L 15/4285; A47L 15/4293; A47L 15/486; A47L 15/502; A47L 15/16; A47L 15/4219; A47L 15/4225; A47L 15/4259; A47L 15/4261; A47L 15/4282; A47L 15/46; A47L 15/488; A47L 15/506; A47L 15/508; A47L 2401/26; A47L 2401/30; A47L 2501/05; A47L 2501/06; A47L 2501/12; A47L 13/20; A47L 15/0018;

A47L 15/0021; A47L 15/0036; A47L 15/0044; A47L 15/0047; A47L 15/0049; A47L 15/0052; A47L 15/0063; A47L 15/0089; A47L 15/14; A47L 15/18; A47L 15/4214; A47L 15/4234; A47L 15/4236; A47L 15/4251; A47L 15/4253; A47L 15/4263; A47L 15/4278; A47L 15/4287; A47L 15/4291; A47L 15/4295; A47L 15/44; A47L 15/48; A47L 15/483; A47L 15/50; A47L 15/501; A47L 15/504; A47L 15/505; A47L 2301/00; A47L 2401/04; A47L 2401/06; A47L 2401/09; A47L 2401/12; A47L 2401/14; A47L 2401/18; A47L 2401/19; A47L 2401/20; A47L 2401/24;

(Continued)

(56) **References Cited**

U.S. PATENT DOCUMENTS

D306,786 S \* 3/1990 Ling ..... D32/3  
D383,880 S \* 9/1997 Good ..... D32/3  
(Continued)

*Primary Examiner* — Khawaja Anwar

(74) *Attorney, Agent, or Firm* — Birch, Stewart, Kolasch & Birch, LLP

(57) **CLAIM**

The ornamental design for rack for dishwasher, as shown and described.

**DESCRIPTION**

- 1. Rack for dishwasher
- 1.1 : Perspective
- 1.2 : Front
- 1.3 : Back
- 1.4 : Left
- 1.5 : Right
- 1.6 : Top

(Continued)

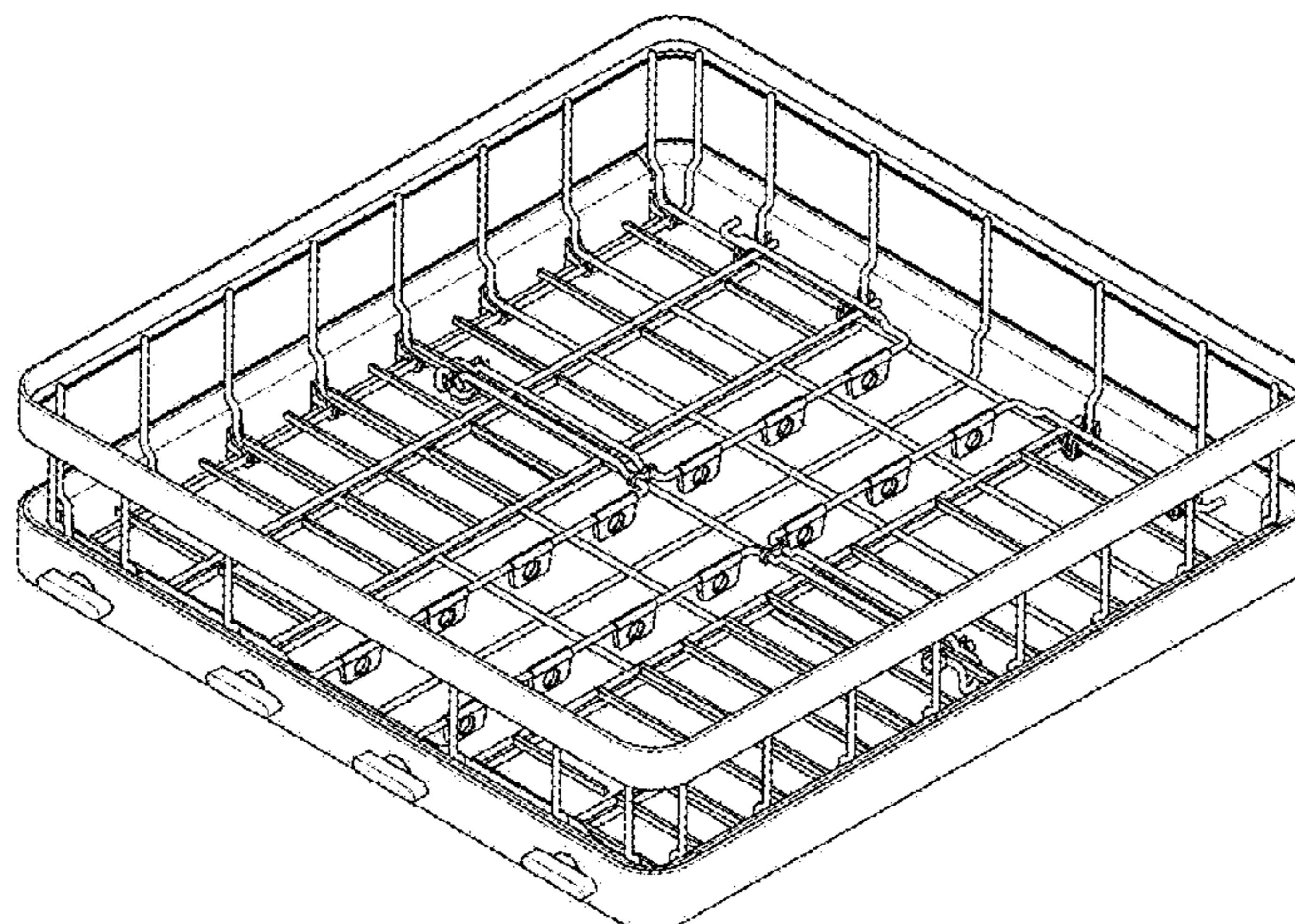

- 1.7 : Bottom
- 1.8 : Reference
- 1.9 : Reference

**1 Claim, 9 Drawing Sheets**

**(58) Field of Classification Search**

CPC ..... A47L 2401/34; A47L 2501/01; A47L  
2501/02; A47L 2501/03; A47L 2501/07;  
A47L 2501/10; A47L 2501/26; A47L  
2501/30; A47L 2501/36; A47L 2601/06;  
A47L 2601/10

See application file for complete search history.

**(56) References Cited**

U.S. PATENT DOCUMENTS

D393,505	S	*	4/1998	Good	.....	D32/3
D506,855	S	*	6/2005	Compagnucci	.....	D32/3
D640,842	S	*	6/2011	Eng	.....	D32/3
D683,504	S	*	5/2013	Clores	.....	D32/3
D688,426	S	*	8/2013	Clores	.....	D32/3
D725,325	S	*	3/2015	Lee	.....	D32/3
D725,851	S	*	3/2015	Lee	.....	D32/3
D752,299	S	*	3/2016	Clores	.....	D32/3
D762,019	S	*	7/2016	Ferencevich	.....	D32/3
D773,751	S	*	12/2016	Hederstierna	.....	D32/3
D827,223	S	*	8/2018	Lee	.....	D32/3
D833,691	S	*	11/2018	Chavez	.....	D32/3
D838,062	S	*	1/2019	Lee	.....	D32/3
D850,031	S	*	5/2019	Han	.....	D32/3
D858,007	S	*	8/2019	Chavez	.....	D32/3

\* cited by examiner

1.1

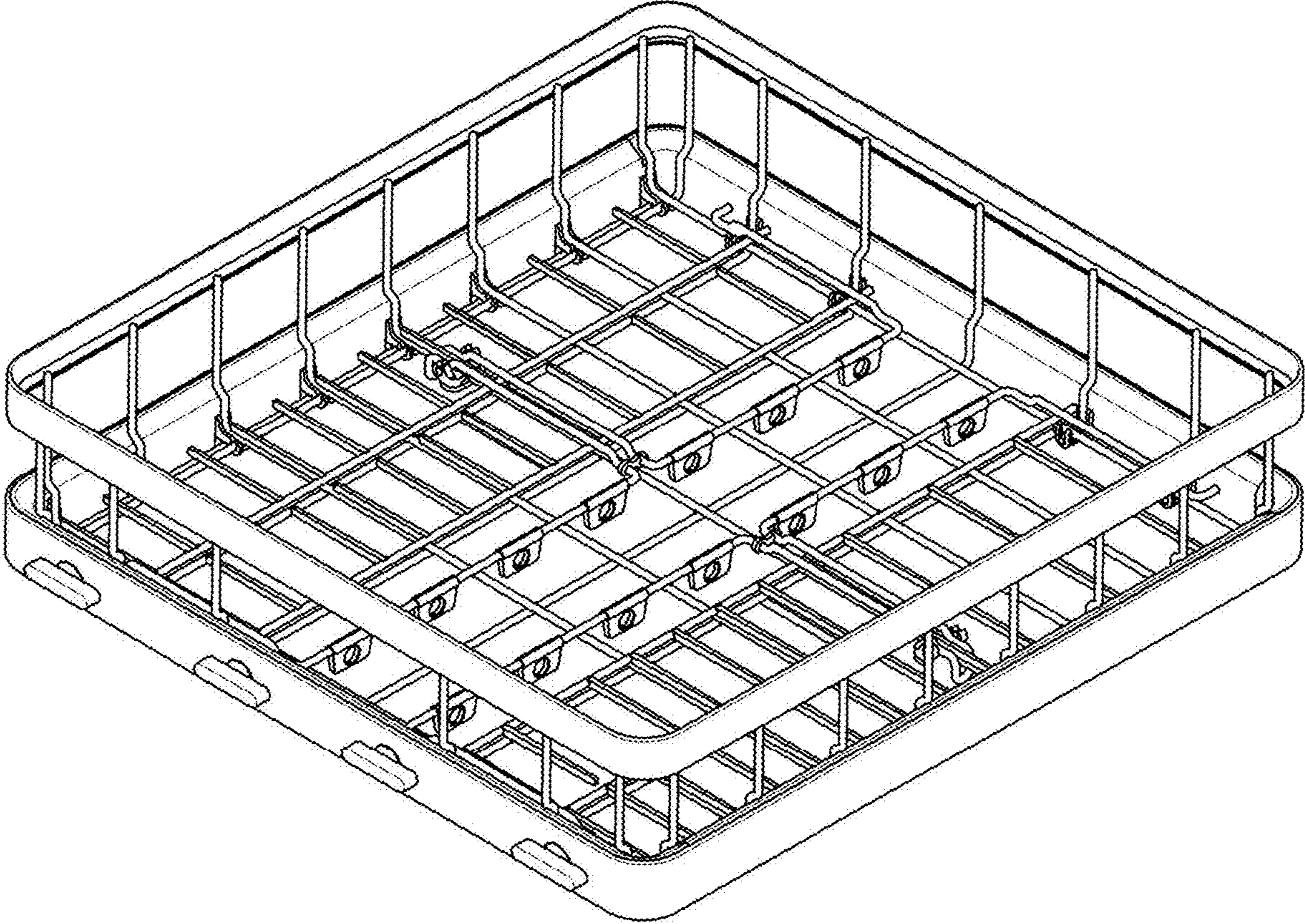

1.2

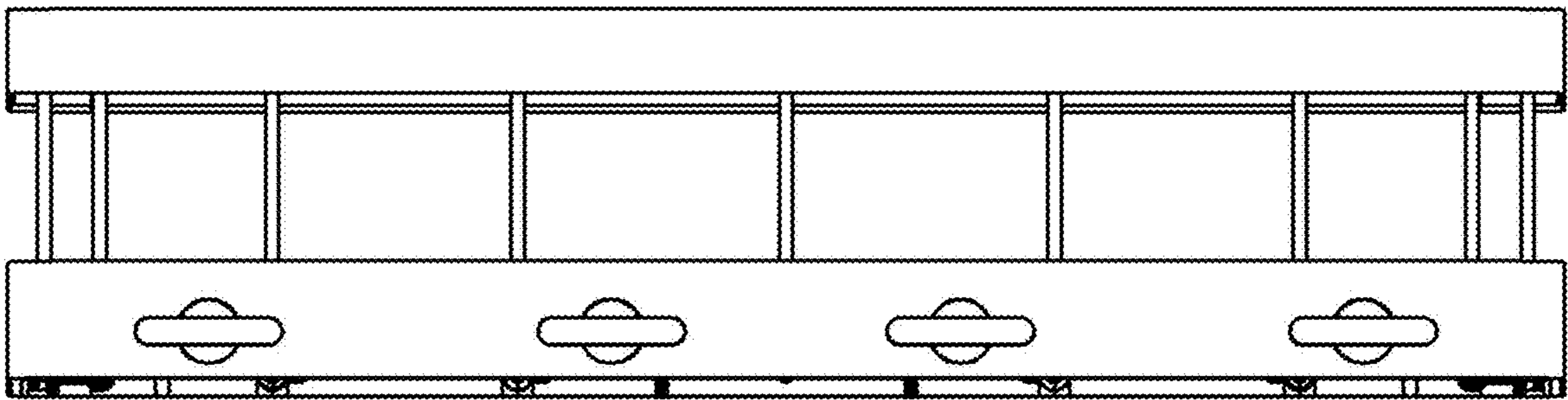

1.3

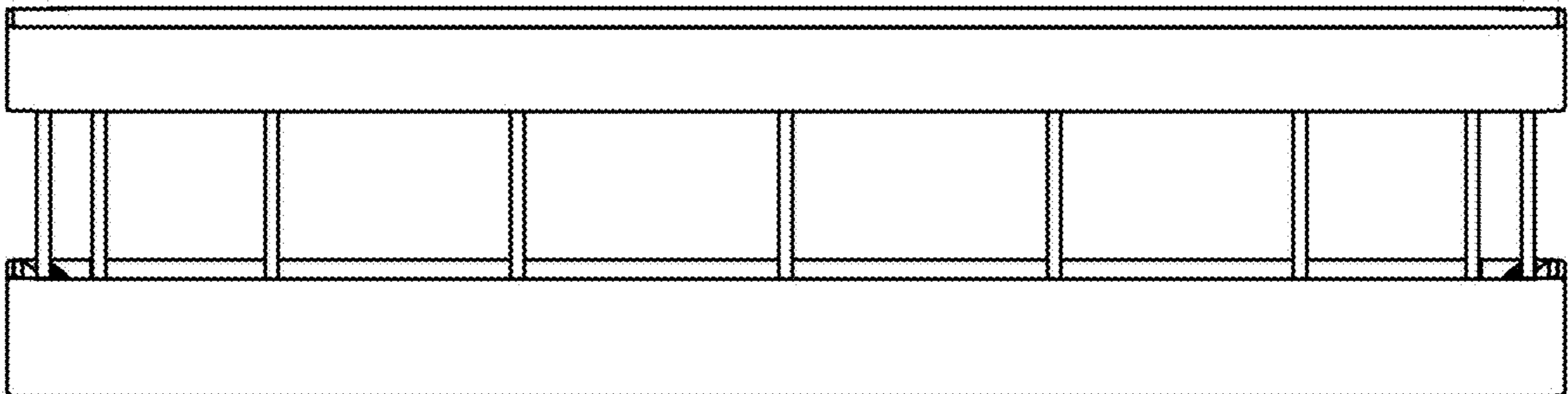

1.4

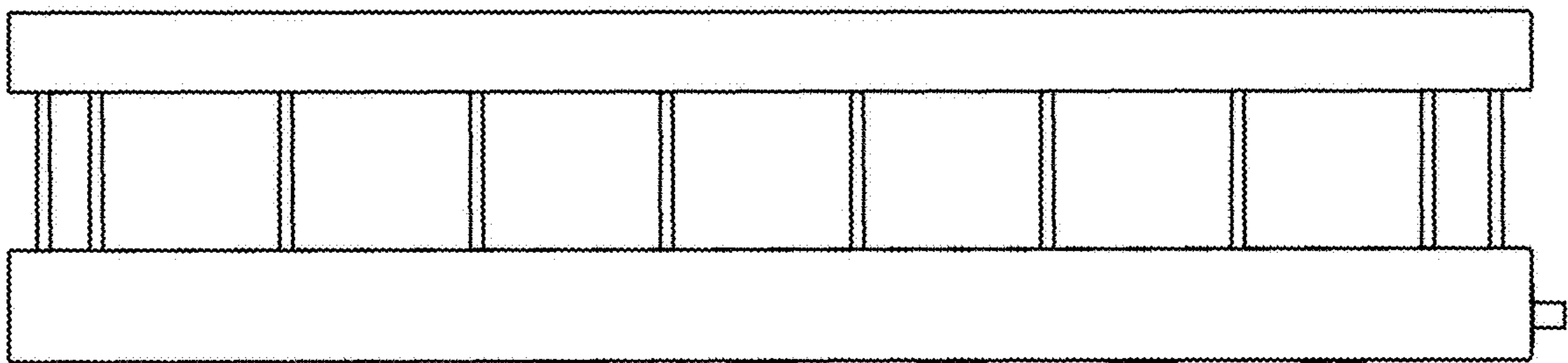

1.5

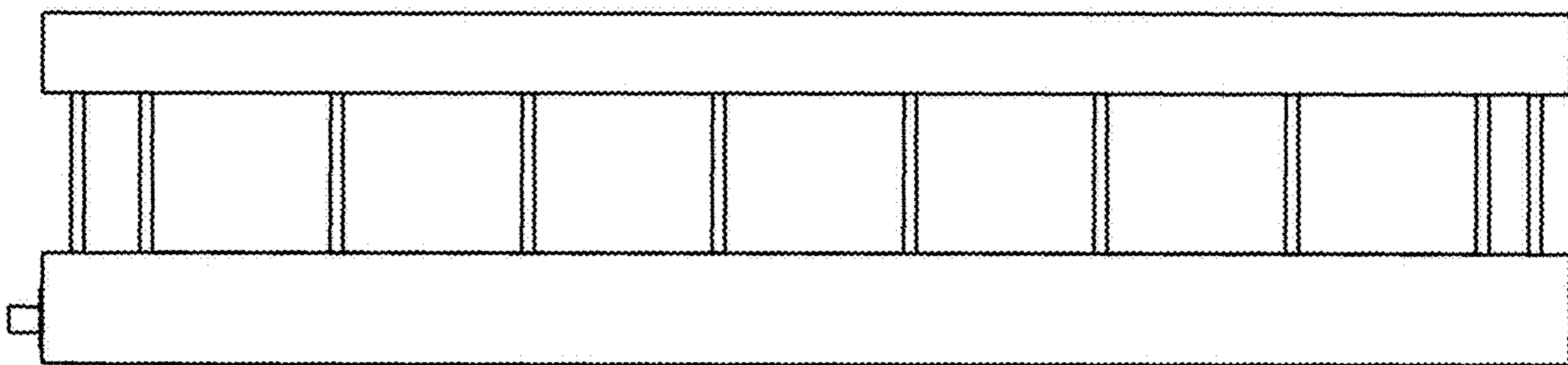

1.6

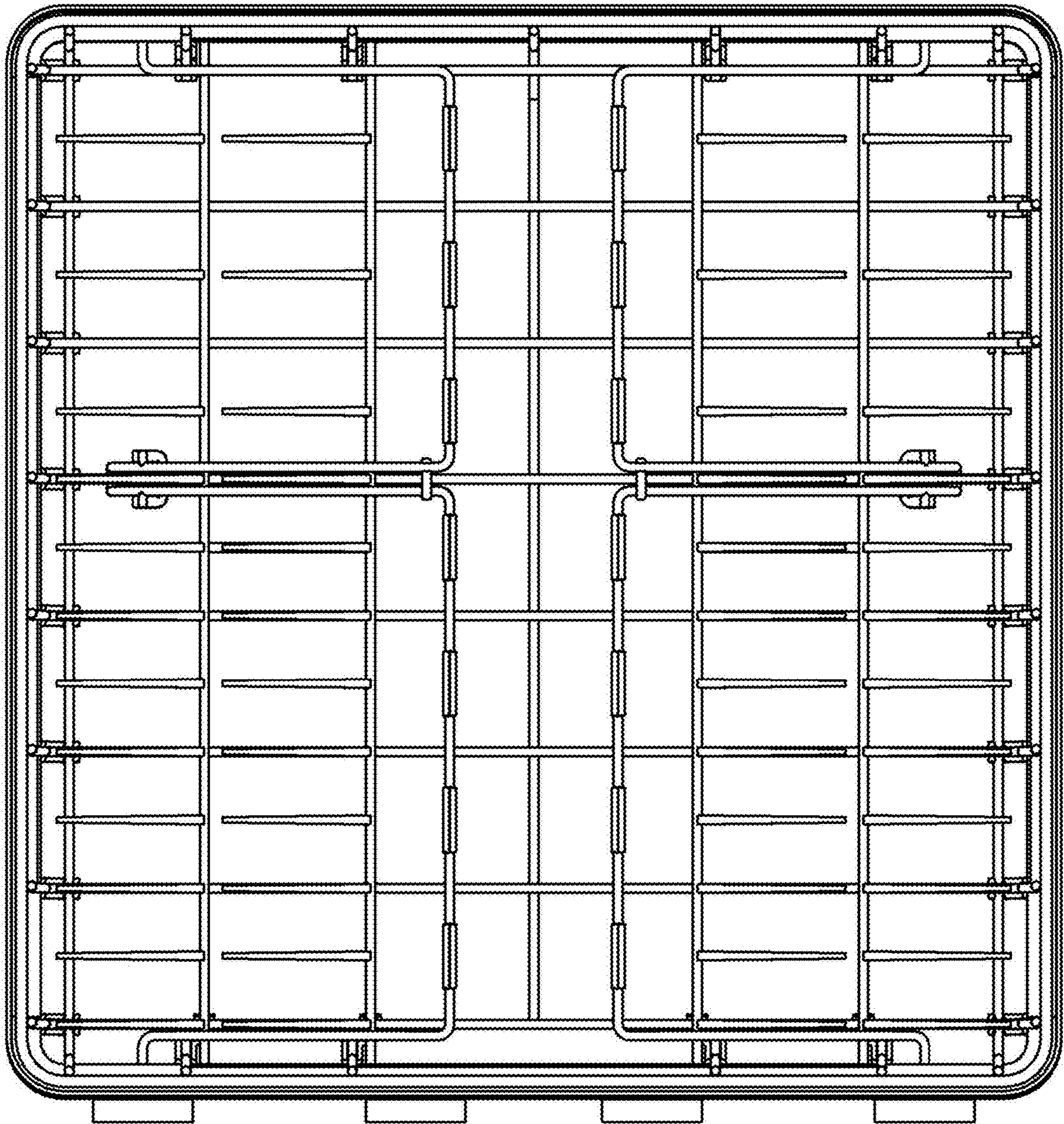



1.7

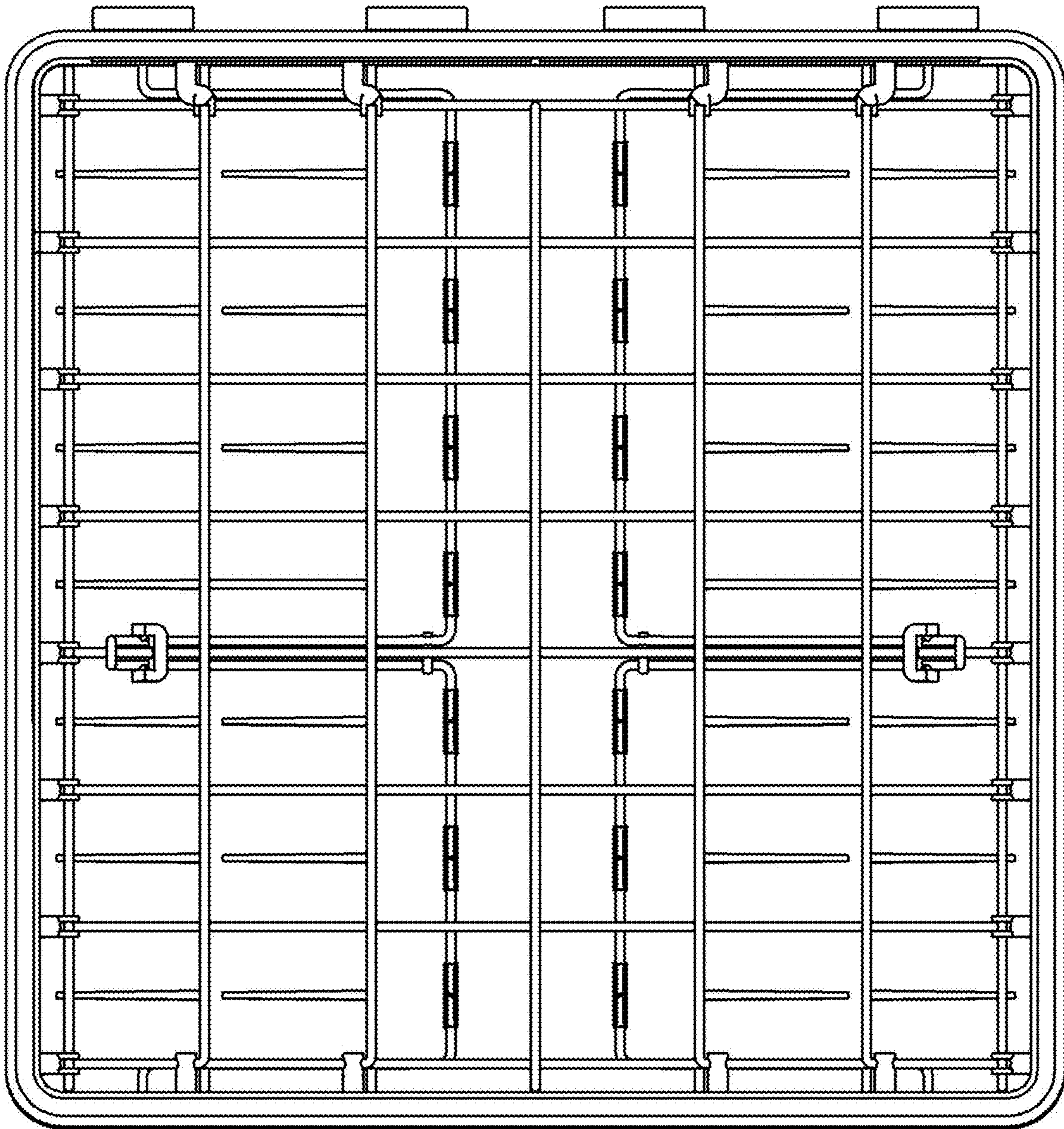

1.8

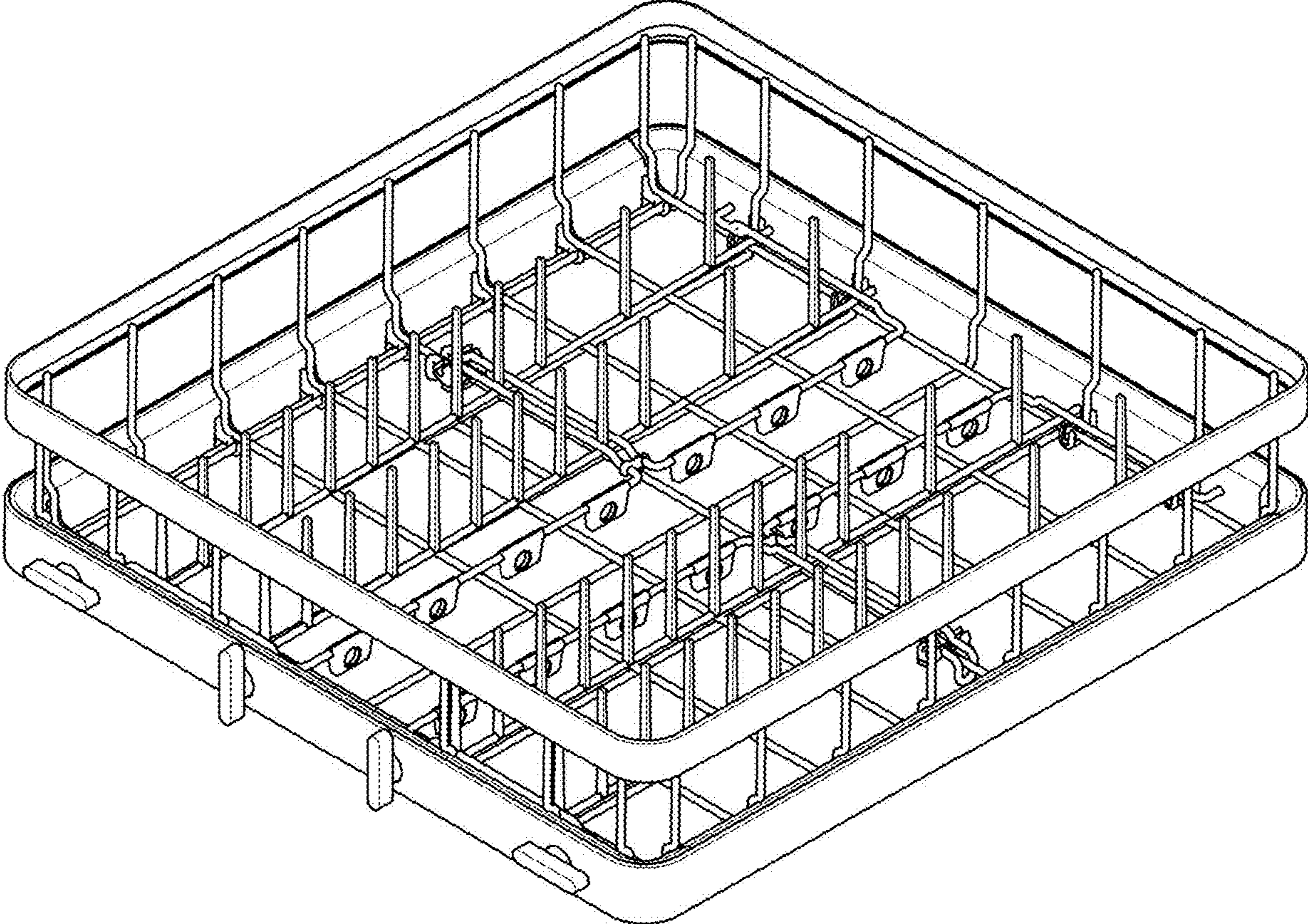

1.9

