



US00D897548S

(12) **United States Design Patent**  
**Liu**

(10) **Patent No.:** **US D897,548 S**

(45) **Date of Patent:** **\*\* Sep. 29, 2020**

(54) **HAIR GROWTH HELMET**

(71) Applicant: **DONGGUAN LESCOLTON INTELLIGENT ELECTRICAL APPLIANCE CO., LTD**, Dongguan (CN)

(72) Inventor: **Jianwen Liu**, Ji'an (CN)

(73) Assignee: **DONGGUAN LESCOLTON INTELLIGENT ELECTRICAL APPLIANCE CO., LTD**, Dongguan (CN)

(\*\*) Term: **15 Years**

(21) Appl. No.: **29/730,350**

(22) Filed: **Apr. 3, 2020**

(51) **LOC (12) Cl.** ..... **28-03**

(52) **U.S. Cl.**  
USPC ..... **D24/200**

(58) **Field of Classification Search**  
USPC ..... D24/200, 215; D29/102-103, 122; D2/870; 607/50, 54, 59, 72-74, 89, 91  
CPC ..... A61N 5/0617; A61N 5/0616; A61N 2005/0645; A61N 2005/0647; A61N 2005/067; A61D 13/05; A42B 3/00  
See application file for complete search history.

(56) **References Cited**

**U.S. PATENT DOCUMENTS**

D456,908 S \* 5/2002 Cunningham ..... D24/200  
D585,994 S \* 2/2009 Mulhauser ..... D24/200  
8,192,473 B2 \* 6/2012 Tucker ..... A61N 5/0616  
606/9  
9,833,633 B2 \* 12/2017 Hamid ..... A61N 5/0617

2010/0242155 A1\* 9/2010 Carullo, Jr. .... A61N 5/0617  
2/171.2  
2011/0022132 A1\* 1/2011 Kim ..... A61N 5/0617  
607/91  
2012/0059440 A1 3/2012 Hamid  
2014/0296946 A1\* 10/2014 Malek ..... A61N 5/0617  
607/89  
2018/0008839 A1 1/2018 Hamid  
2019/0269935 A1\* 9/2019 Kurata ..... A61N 5/0617

**FOREIGN PATENT DOCUMENTS**

CN 303778715 \* 12/2015  
KR 300895978.0000 \* 1/2016

\* cited by examiner

*Primary Examiner* — Wan Laymon

(57) **CLAIM**

The ornamental design for a hair growth helmet, as shown and described.

**DESCRIPTION**

FIG. 1 is a perspective view of a hair growth helmet showing my new design;  
FIG. 2 is another perspective view thereof;  
FIG. 3 is another perspective view thereof;  
FIG. 4 is a front elevational view thereof  
FIG. 5 is a rear elevational view thereof;  
FIG. 6 is a left side elevational view thereof;  
FIG. 7 is a right side elevational view thereof;  
FIG. 8 is a top plan view thereof; and,  
FIG. 9 is a bottom plan view thereof.

The broken lines in the drawings depict boundaries of the hair growth helmet that form no part of the claimed design.

**1 Claim, 9 Drawing Sheets**

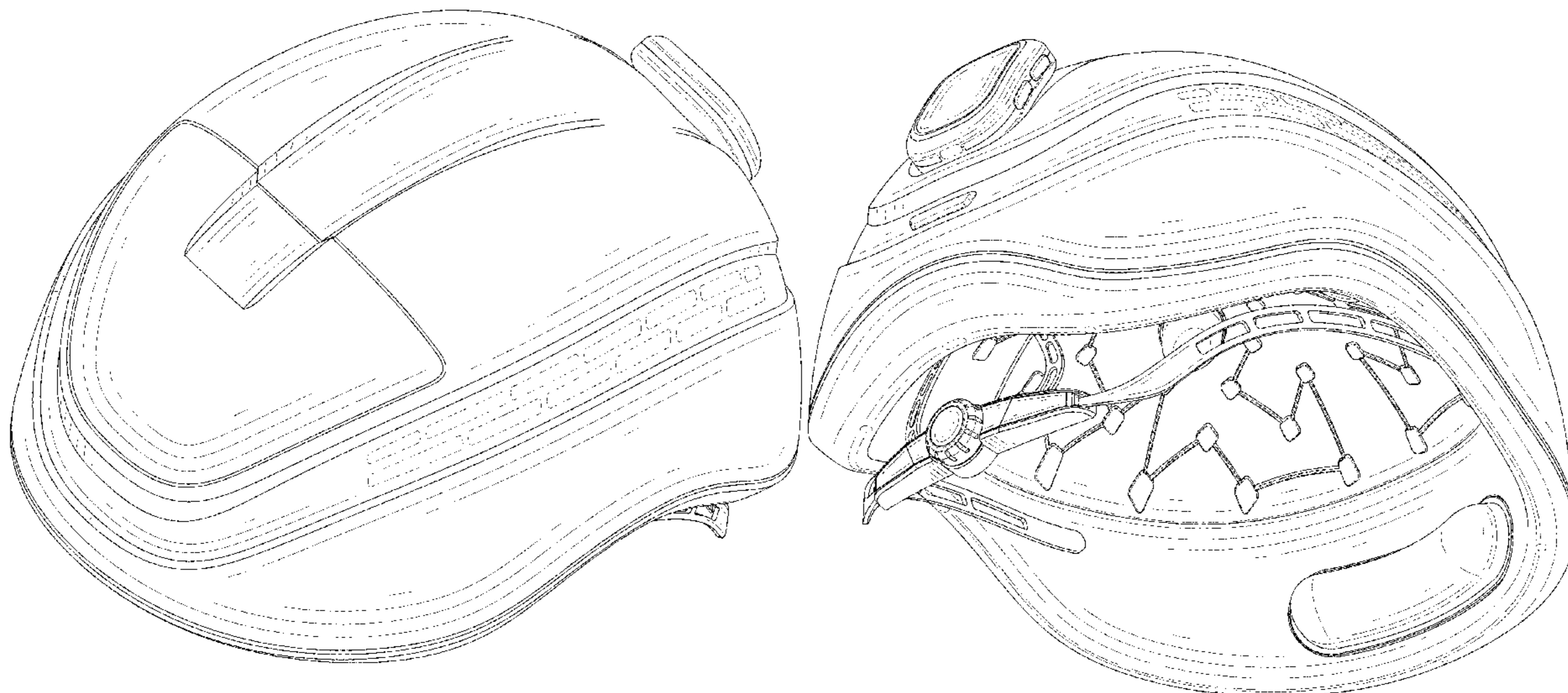

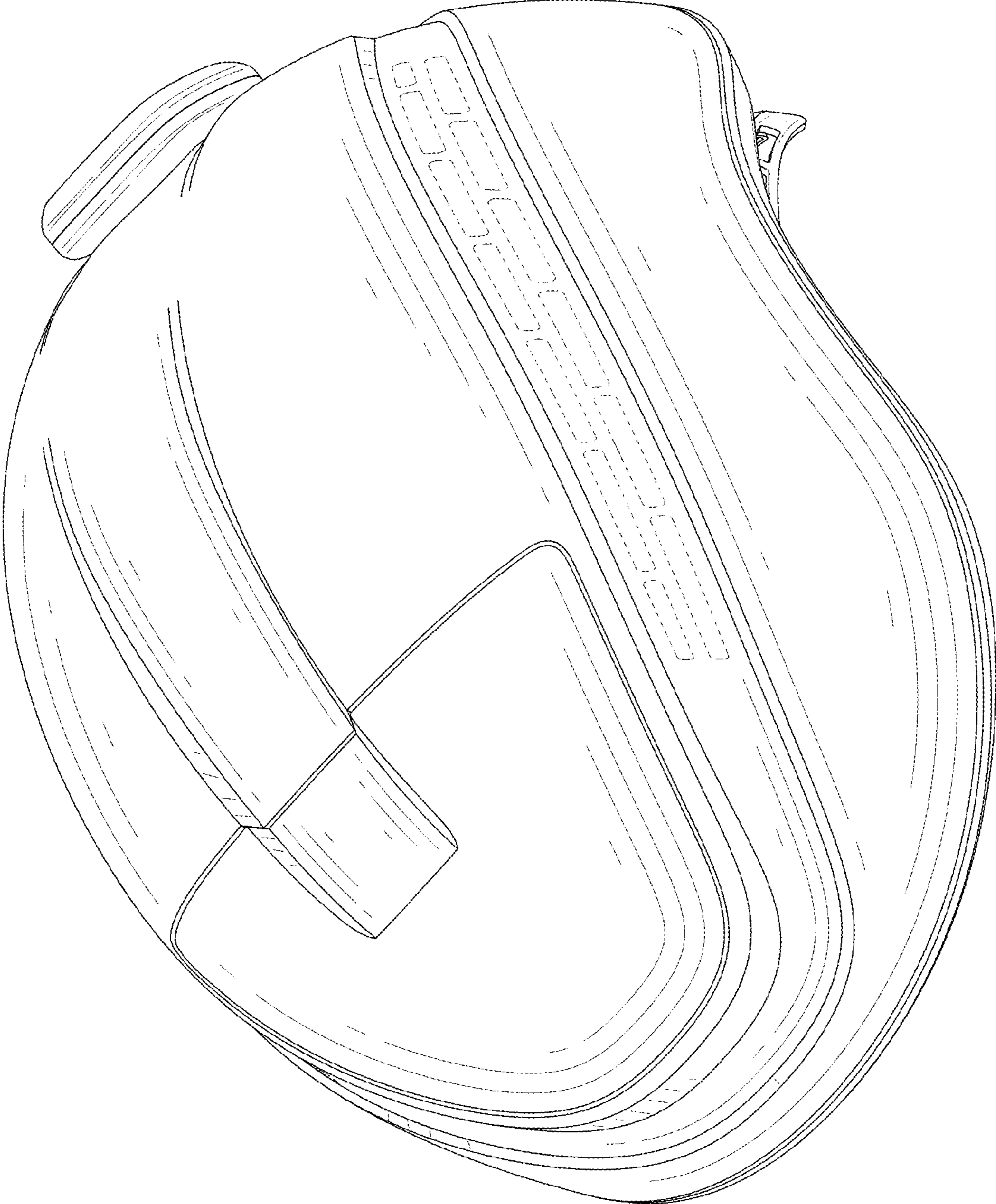

FIG. 1

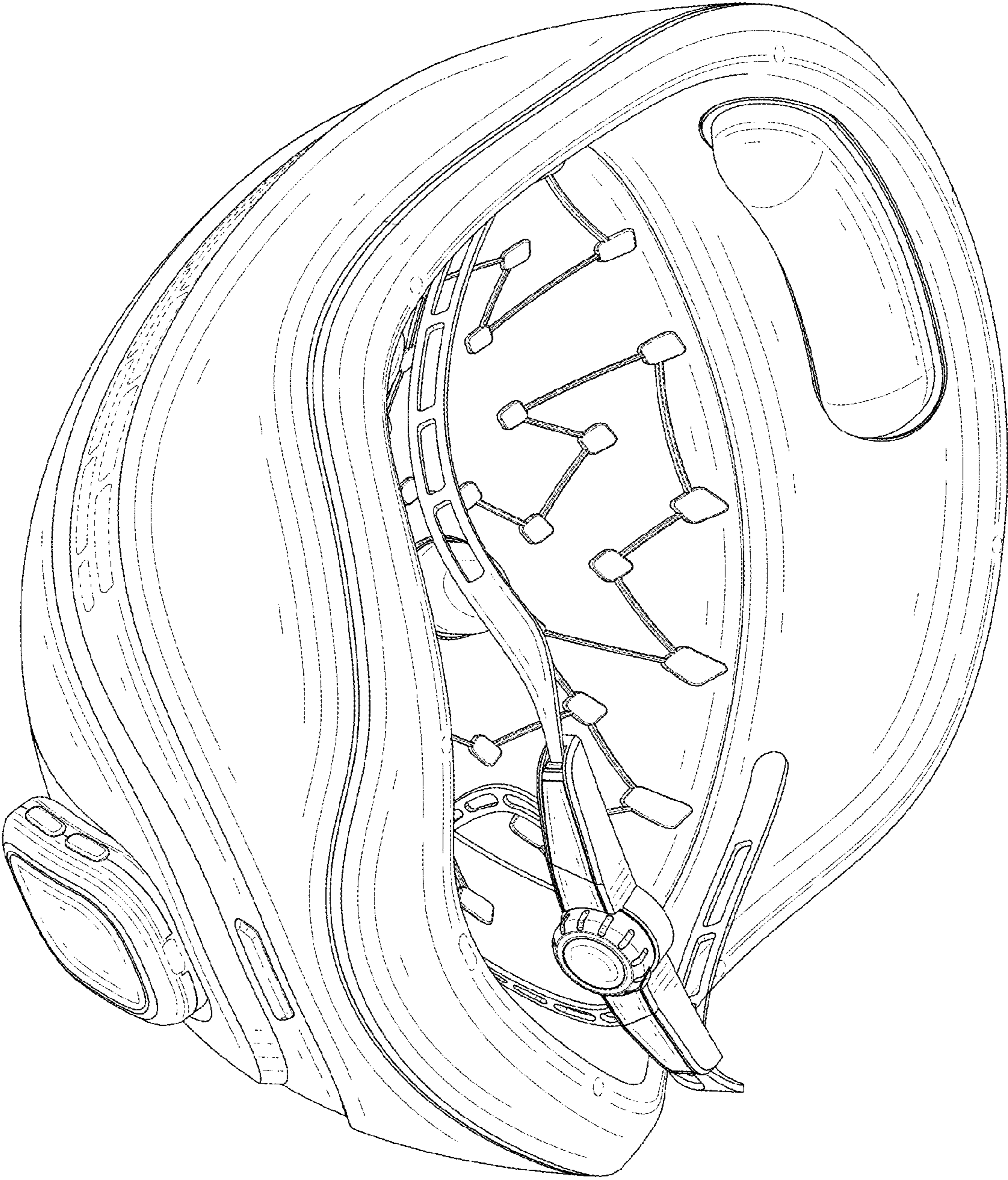

FIG. 2

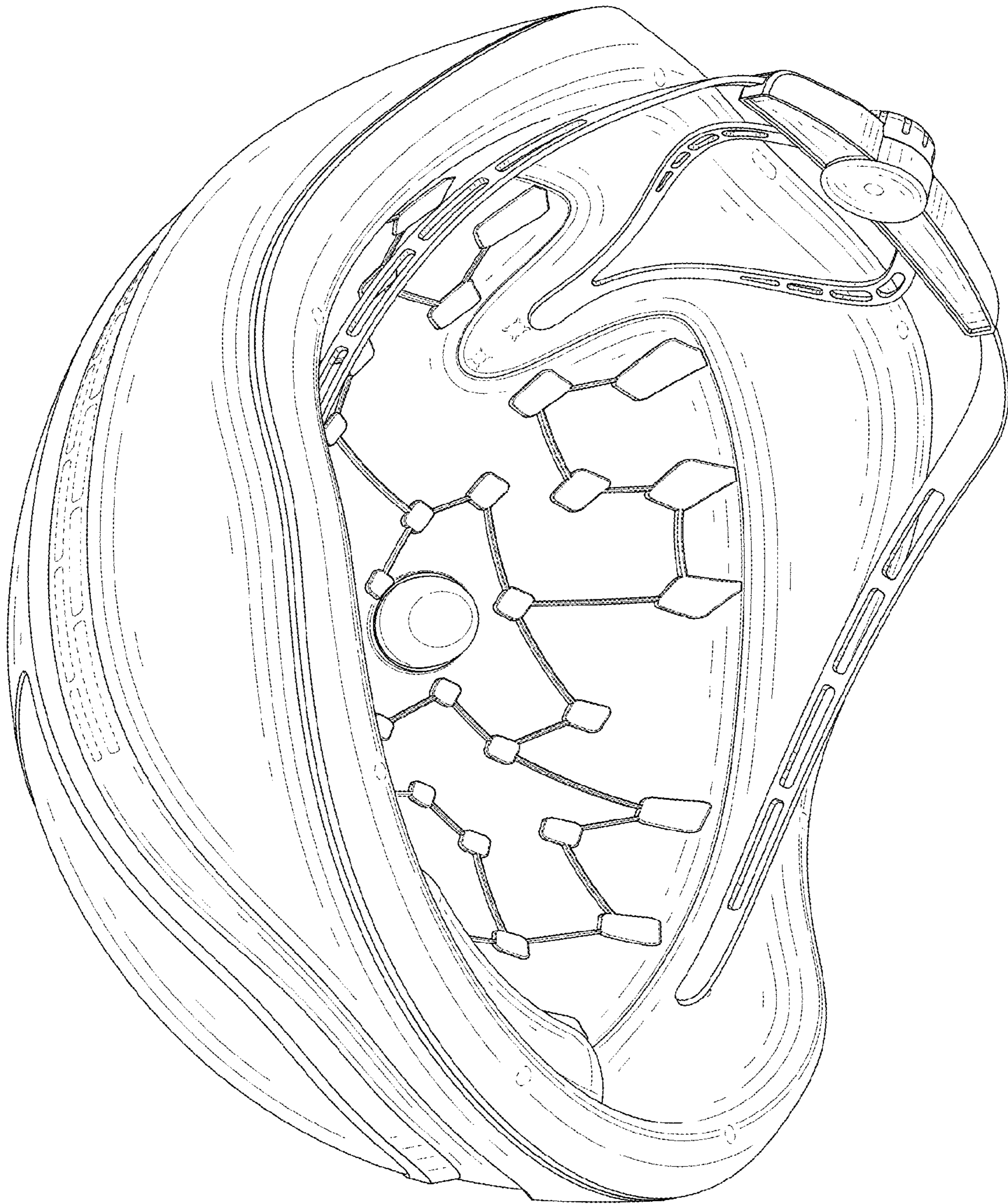

FIG. 3

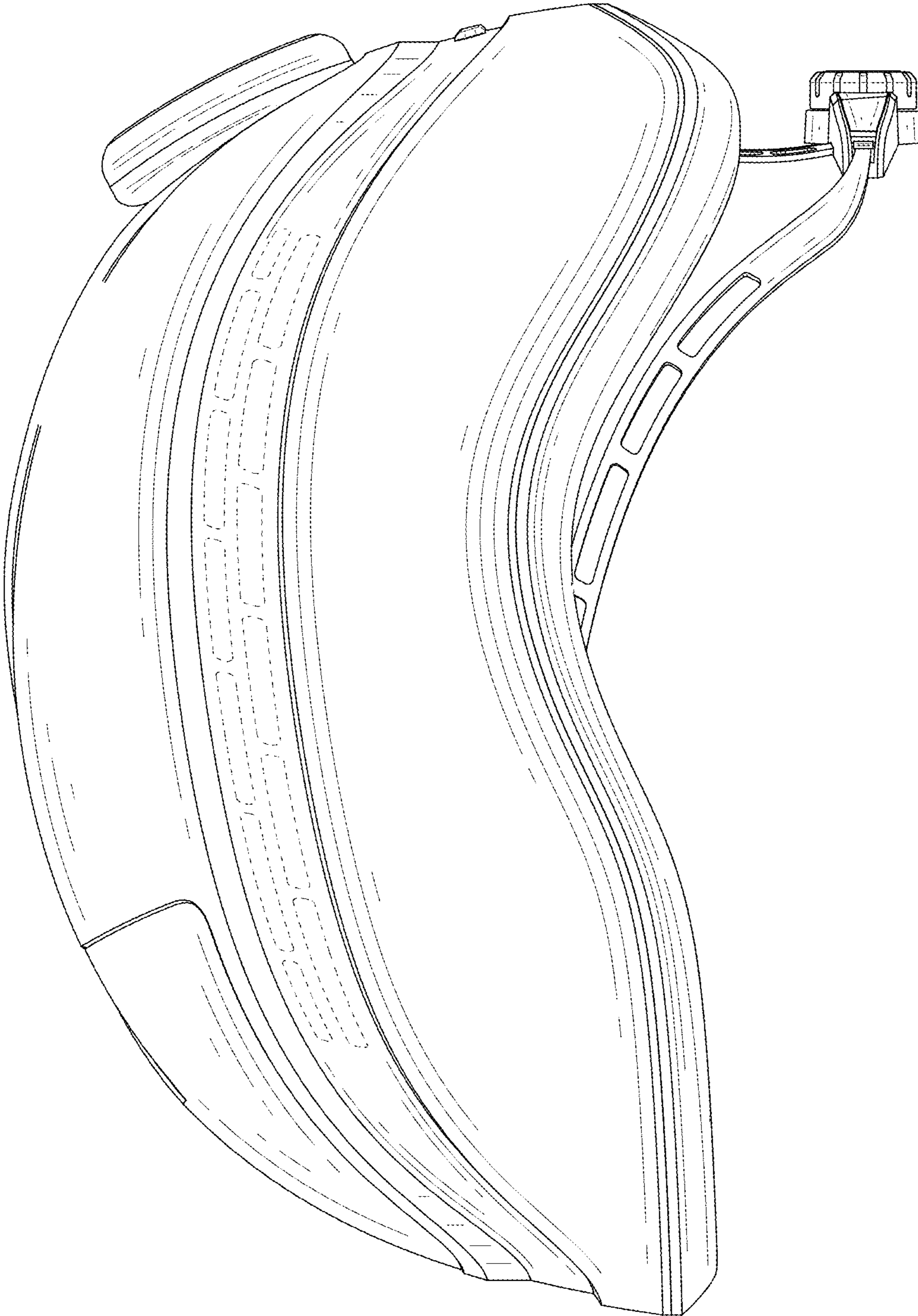

FIG. 4

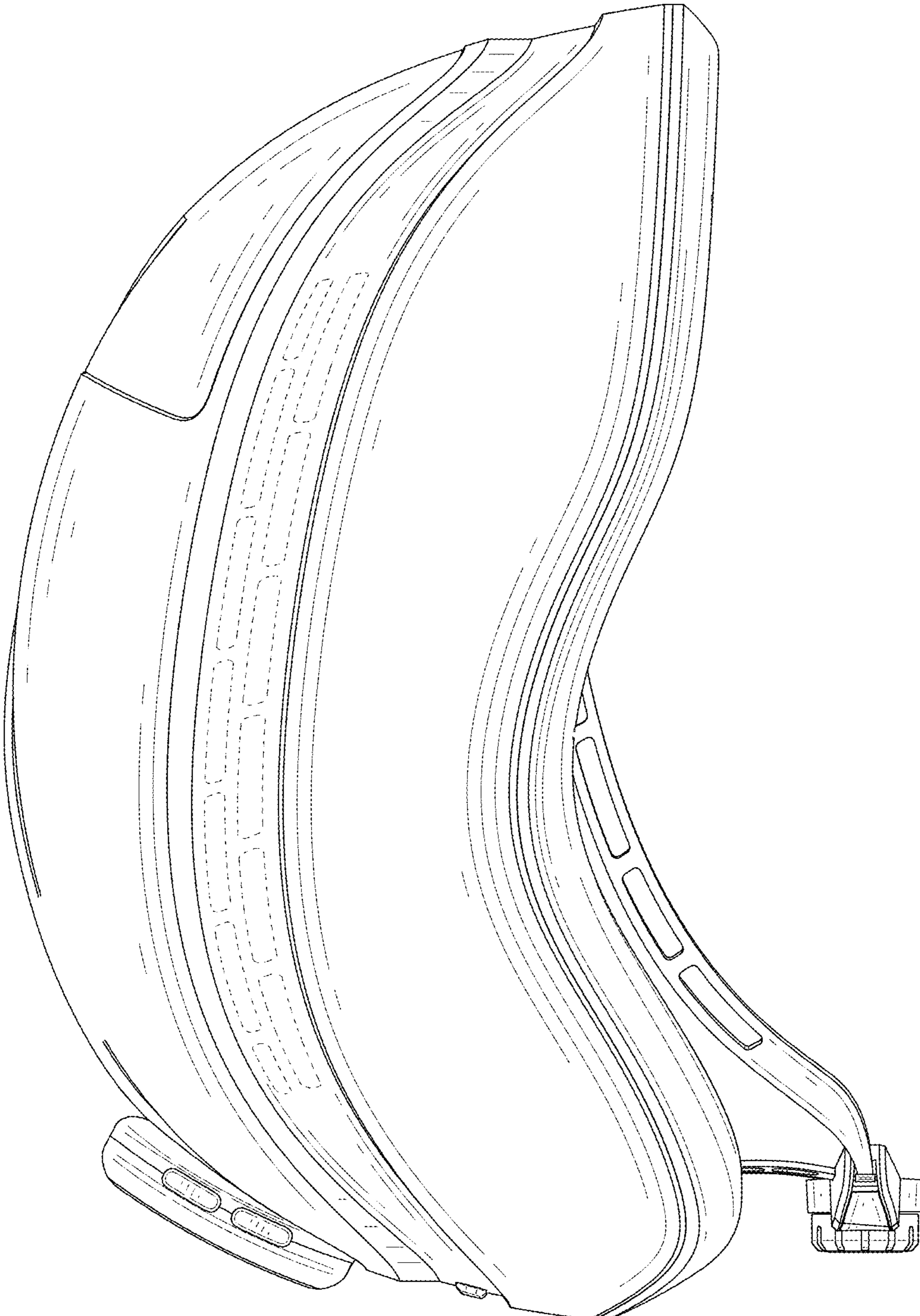

FIG. 5

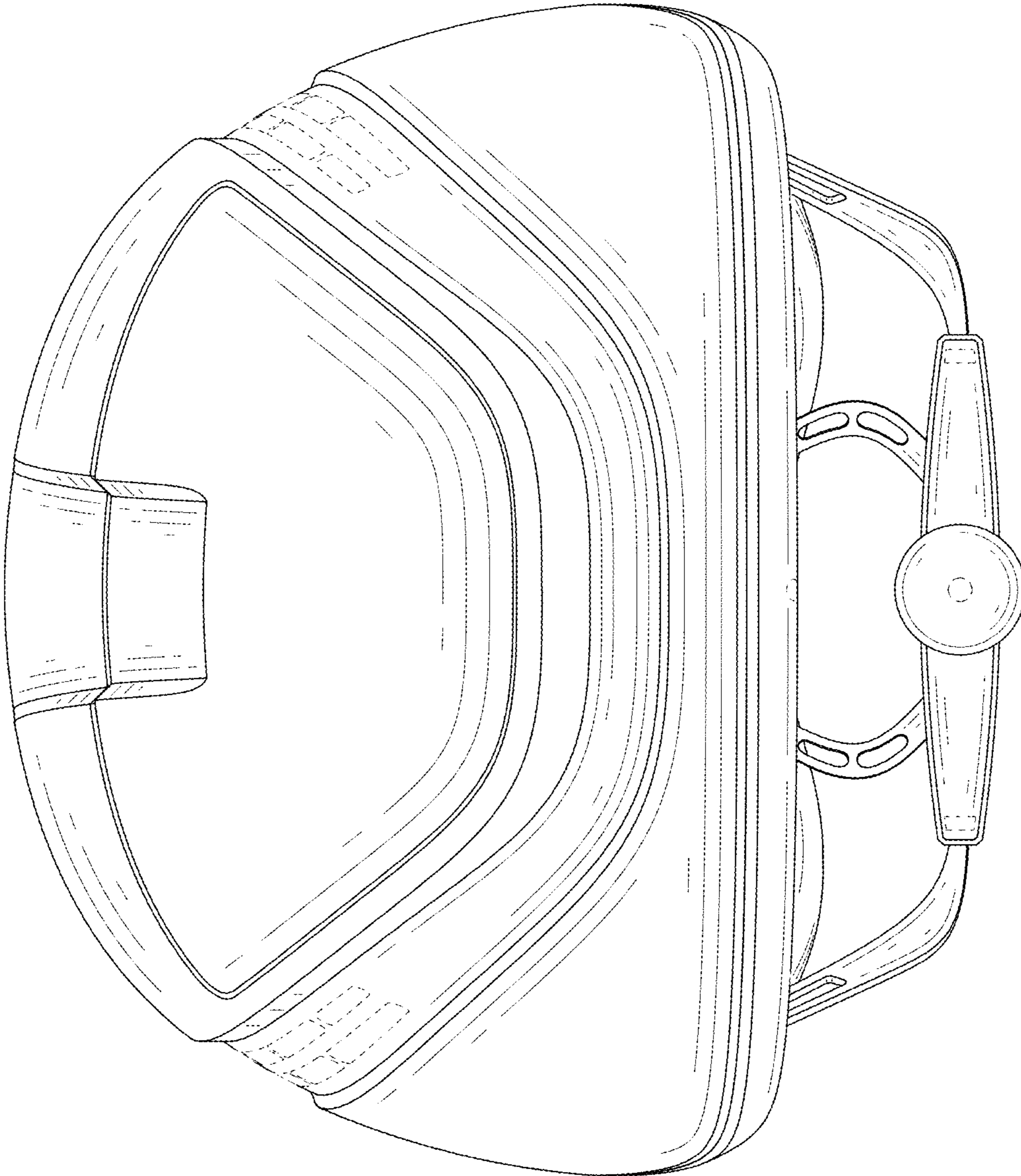

FIG. 6

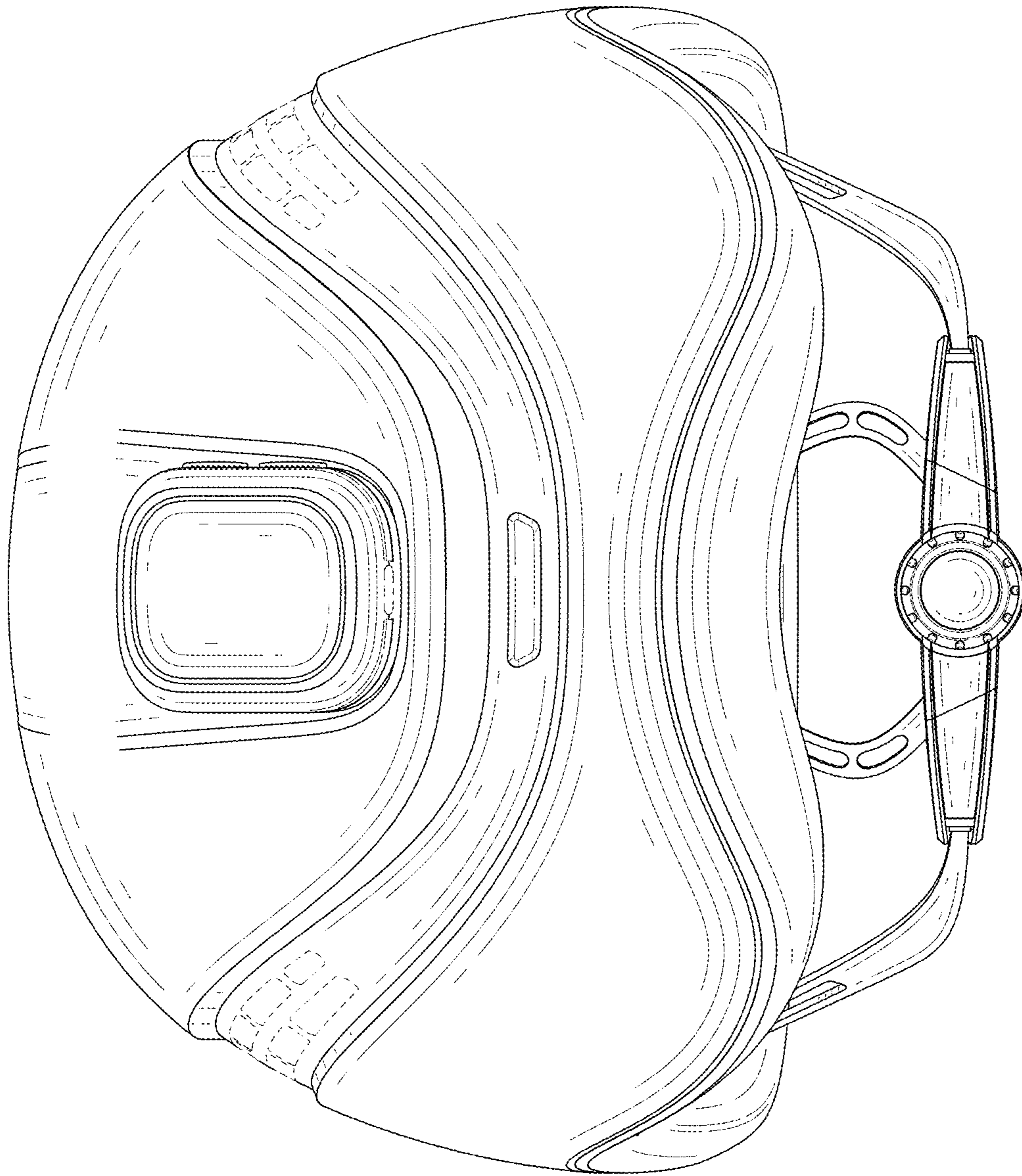

FIG. 7



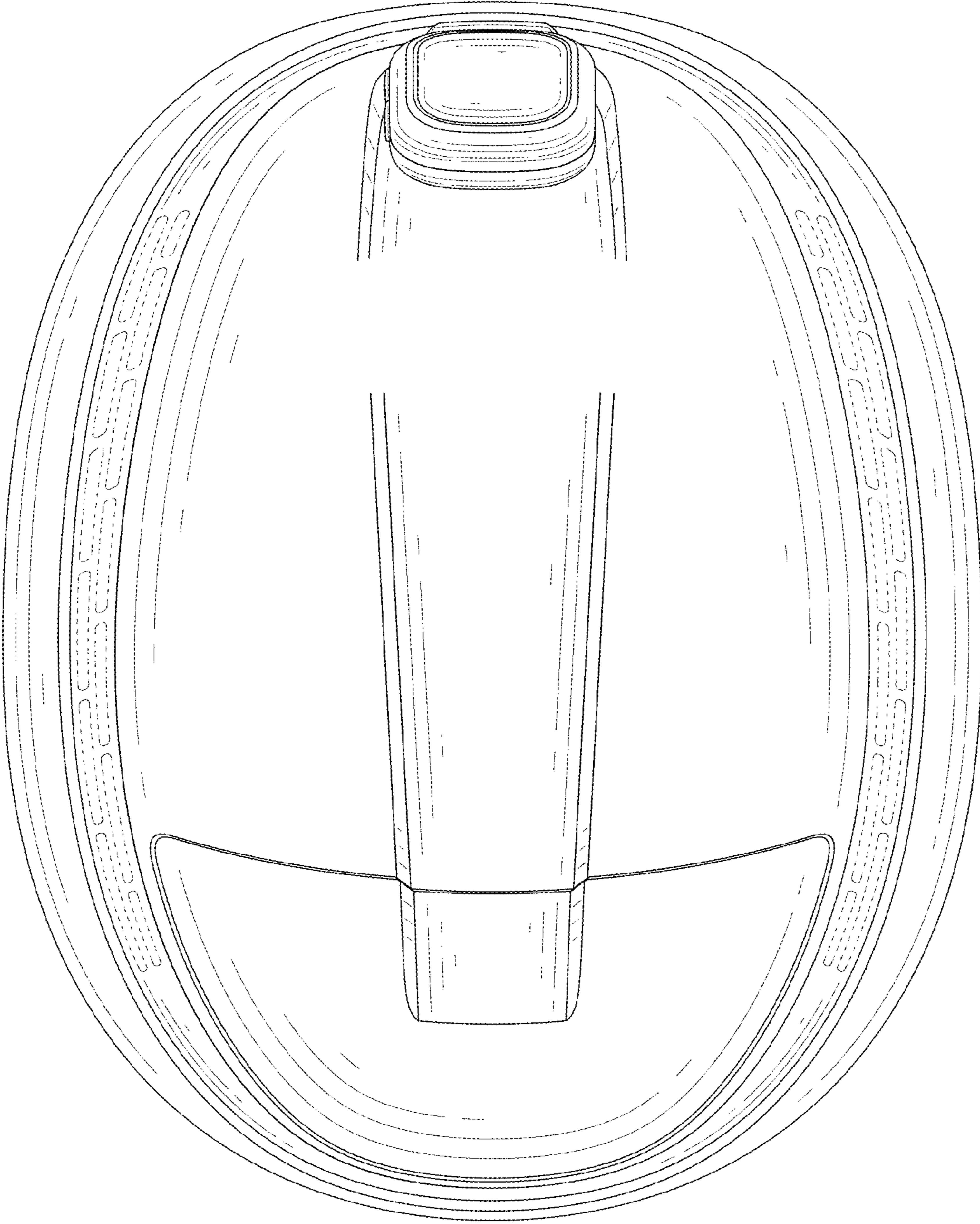

FIG. 8

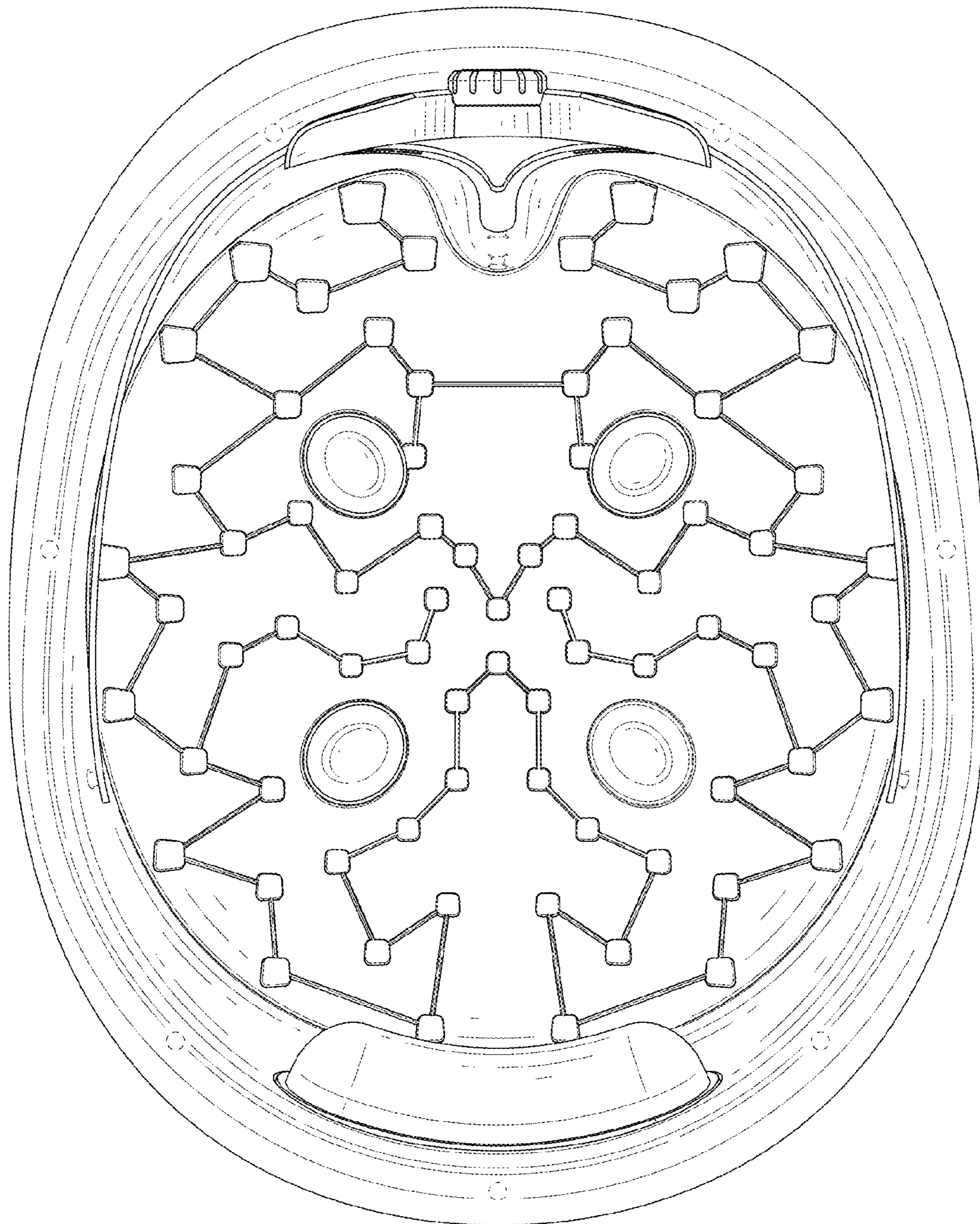

FIG. 9