



US00D897542S

(12) **United States Design Patent** (10) **Patent No.:** **US D897,542 S**
Klock et al. (45) **Date of Patent:** **** *Sep. 29, 2020**

(54) **MEDICAL DEVICE WITH INDICATOR LIGHT**

(71) Applicant: **Bruin Biometrics, LLC**, Los Angeles, CA (US)

(72) Inventors: **Paul J. Klock**, Carlsbad, CA (US);
Martin F. Burns, Los Angeles, CA (US)

(73) Assignee: **Bruin Biometrics, LLC**, Los Angeles, CA (US)

(*) Notice: This patent is subject to a terminal disclaimer.

(**) Term: **15 Years**

(21) Appl. No.: **29/662,461**

(22) Filed: **Sep. 5, 2018**

(51) **LOC (12) Cl.** **24-01**

(52) **U.S. Cl.**
USPC **D24/186**

(58) **Field of Classification Search**
USPC D24/137, 146, 152, 158, 160, 176, 186,
D24/187, 200, 209–215

(Continued)

(56) **References Cited**

U.S. PATENT DOCUMENTS

D356,641 S * 3/1995 Stewart D24/176
D659,840 S * 5/2012 Cheng D24/137

(Continued)

FOREIGN PATENT DOCUMENTS

JP D1154585 * 9/2002

OTHER PUBLICATIONS

Design U.S. Appl. No. 29/662,454, filed Sep. 5, 2018.

(Continued)

Primary Examiner — Lilyana Bekic

Assistant Examiner — Mary Shannon Malley

(74) *Attorney, Agent, or Firm* — Arnold & Porter Kaye Scholer LLP

(57) **CLAIM**

The ornamental design for a medical device with indicator light, as shown and described.

DESCRIPTION

The patent or application file contains at least one drawing executed in color. Copies of this patent or patent application publication with color drawings will be provided by the Office upon request and payment of the necessary fee.

FIG. 1 is a first perspective view of a medical device with indicator light.

FIG. 2 is a second perspective view of the medical device with indicator light of FIG. 1.

FIG. 3 is a front view of the medical device with indicator light of FIG. 1.

FIG. 4 is a rear view of the medical device with indicator light of FIG. 1.

FIG. 5 is a left-hand-side view of the medical device with indicator light of FIG. 1.

FIG. 6 is a right-hand-side view of the medical device with indicator light of FIG. 1.

FIG. 7 is a bottom view of the medical device with indicator light of FIG. 1.

FIG. 8 is a top view of the medical device with indicator light of FIG. 1.

FIG. 9 is a first perspective view of a second embodiment of a medical device with indicator light.

FIG. 10 is a second perspective view of the medical device with indicator light of FIG. 9.

FIG. 11 is a front view of the medical device with indicator light of FIG. 9.

FIG. 12 is a rear view of the medical device with indicator light of FIG. 9.

FIG. 13 is a left-hand-side view of the medical device with indicator light of FIG. 9.

FIG. 14 is a right-hand-side view of the medical device with indicator light of FIG. 9.

(Continued)

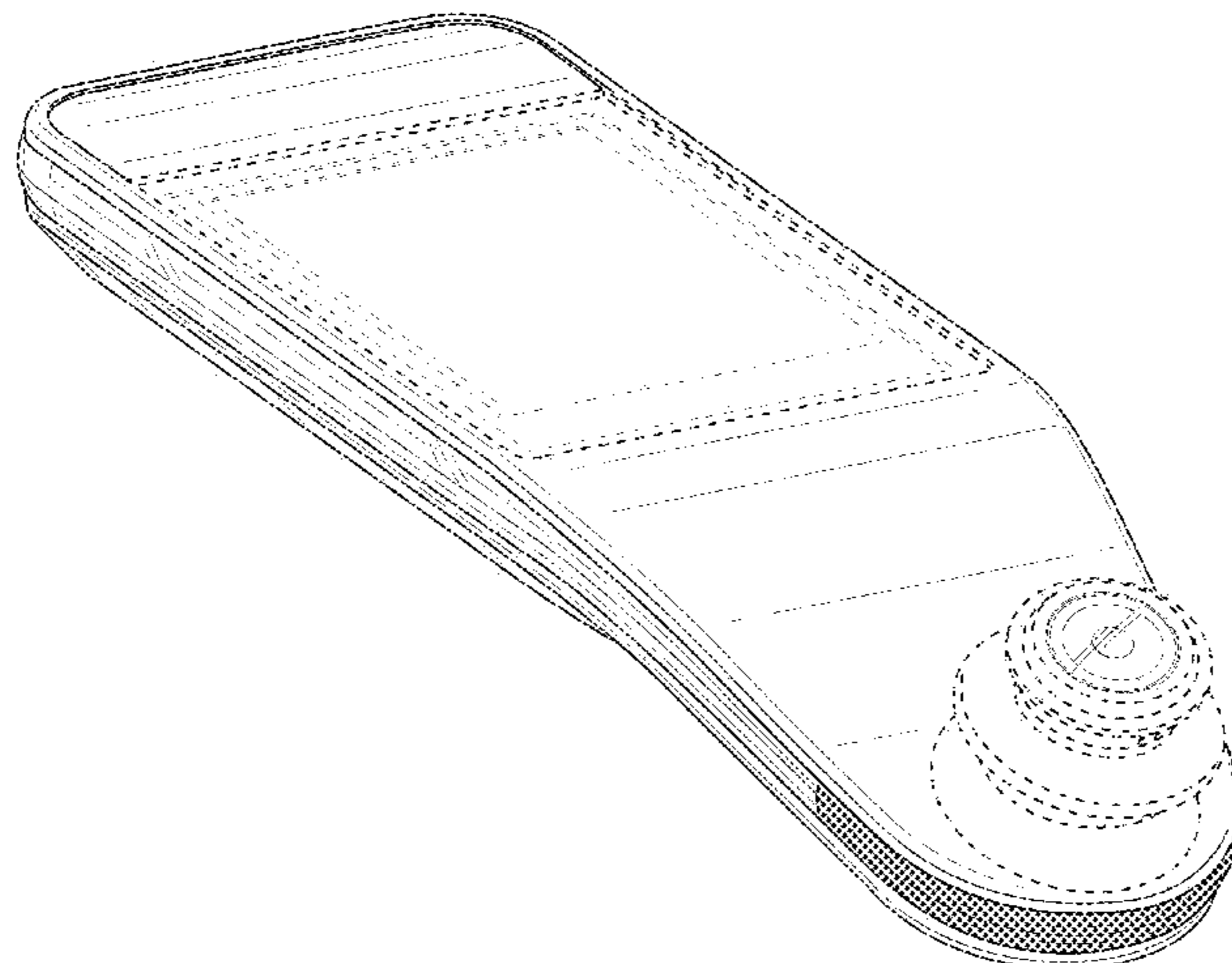

FIG. 15 is a bottom view of the medical device with indicator light of FIG. 9; and, FIG. 16 is a top view of the medical device with indicator light of FIG. 9. The broken lines depict portions of the medical device with indicator light that form no part of the claim.

**1 Claim, 14 Drawing Sheets
(14 of 14 Drawing Sheet(s) Filed in Color)**

(58) **Field of Classification Search**

CPC A61B 5/0537; A61B 5/0531; A61B 5/445;
A61B 5/447; A61B 5/4875; A61B
5/6801; A61B 5/7278; A61B 5/741; A61B
5/746; A61B 5/6843; A61B 2560/0468;
A61B 2562/046

See application file for complete search history.

(56)

References Cited

U.S. PATENT DOCUMENTS

| | | | | | | |
|-----------|----|---|---------|---------|-------|------------|
| D673,681 | S | * | 1/2013 | Boudier | | D24/158 |
| D742,518 | S | * | 11/2015 | Barak | | D24/158 |
| D789,545 | S | * | 6/2017 | Pippel | | D24/186 |
| 9,763,596 | B2 | * | 9/2017 | Tonar | | A61B 5/445 |
| D834,713 | S | * | 11/2018 | Myers | | D24/137 |
| D850,626 | S | * | 6/2019 | Gardner | | D24/186 |
| D857,911 | S | * | 8/2019 | Huang | | D24/215 |
| D863,574 | S | * | 10/2019 | Yan | | D24/200 |

OTHER PUBLICATIONS

Design U.S. Appl. No. 29/677,160, filed Jan. 17, 2019.
Design U.S. Appl. No. 29/677,186, filed Jan. 17, 2019.
Design U.S. Appl. No. 29/679,908, filed Feb. 11, 2019.

* cited by examiner

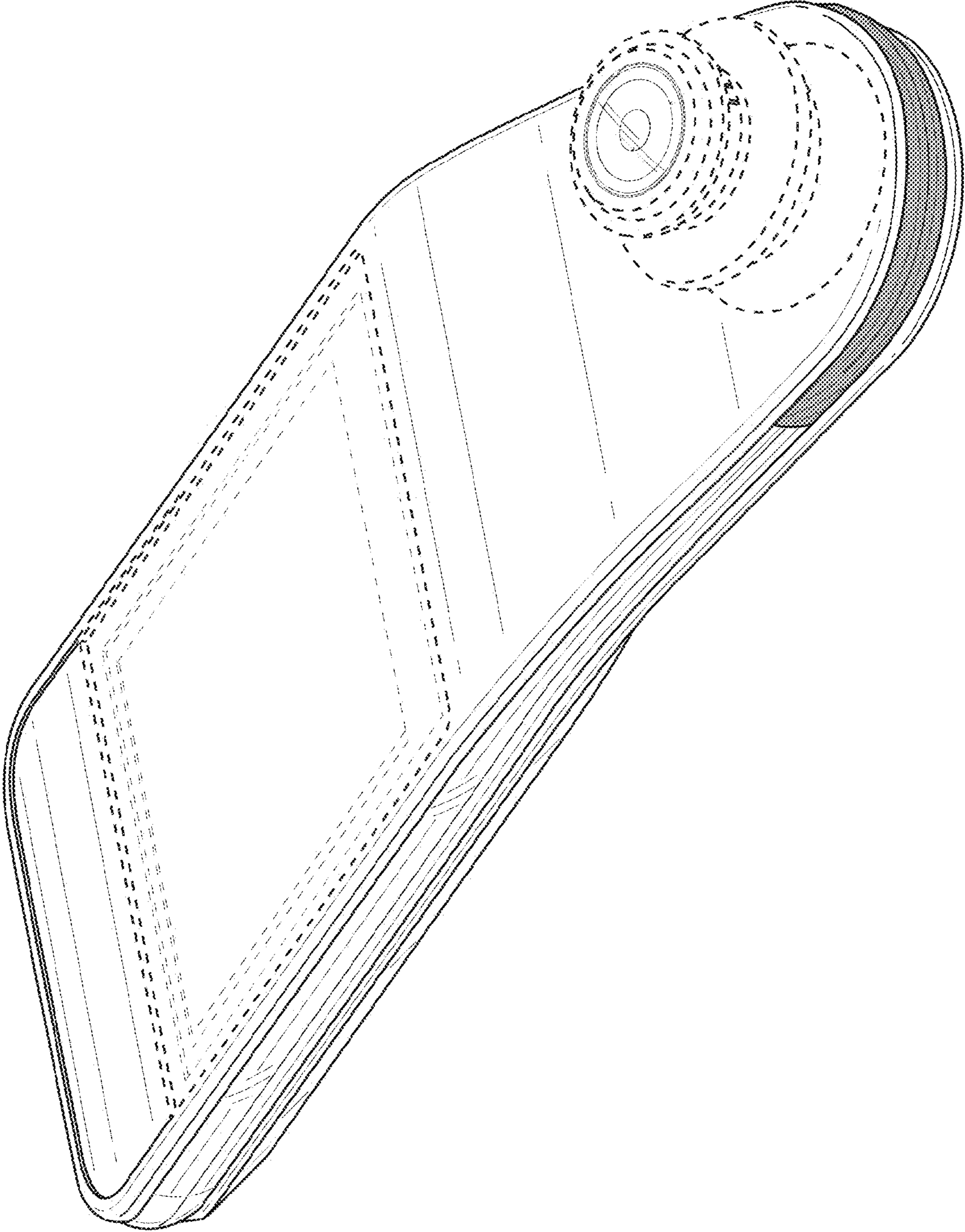

FIG. 1

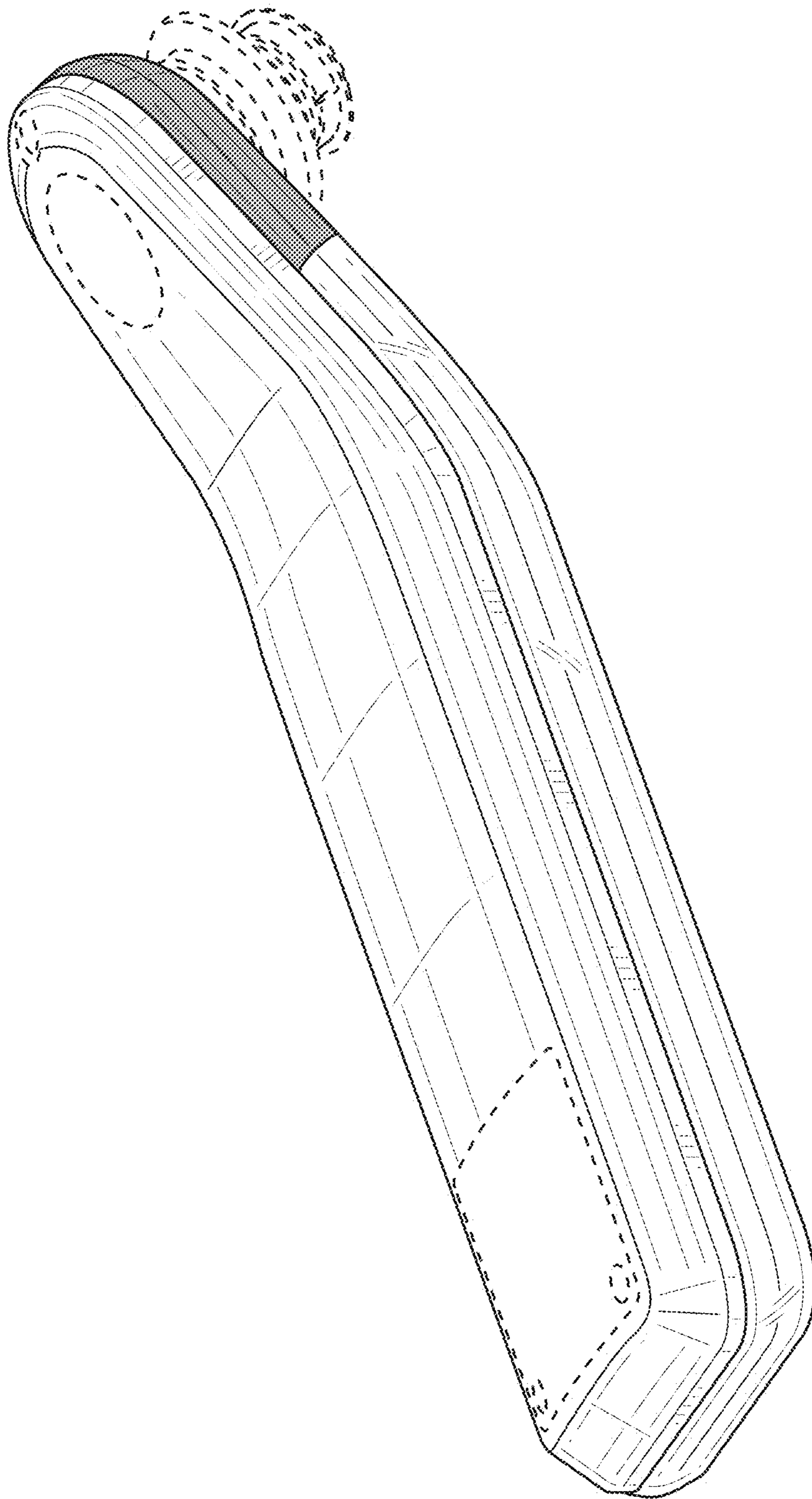

FIG. 2

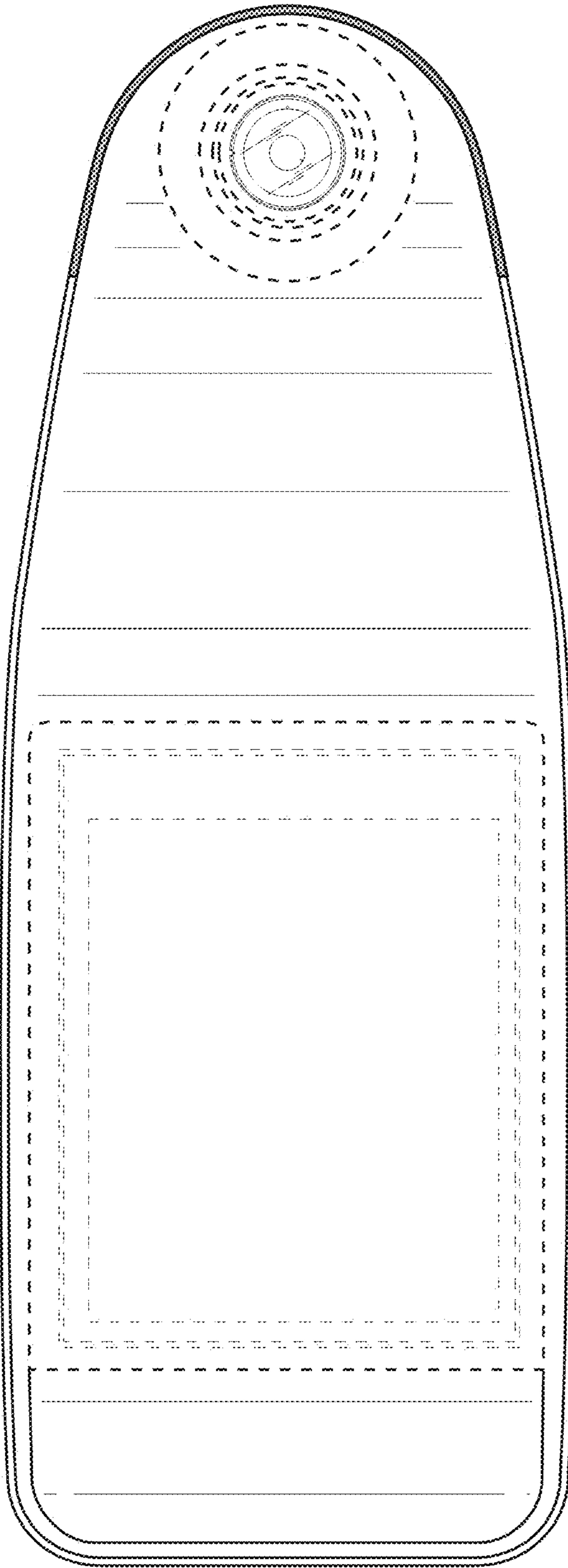

FIG. 3

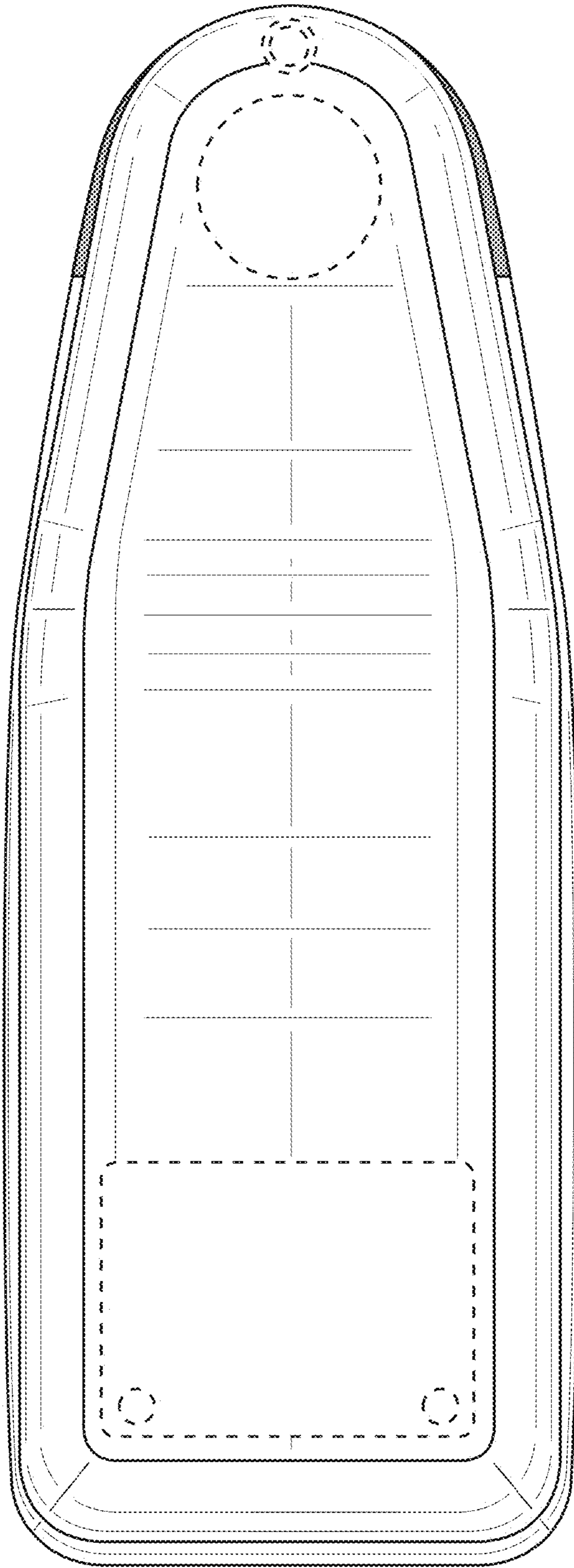

FIG. 4

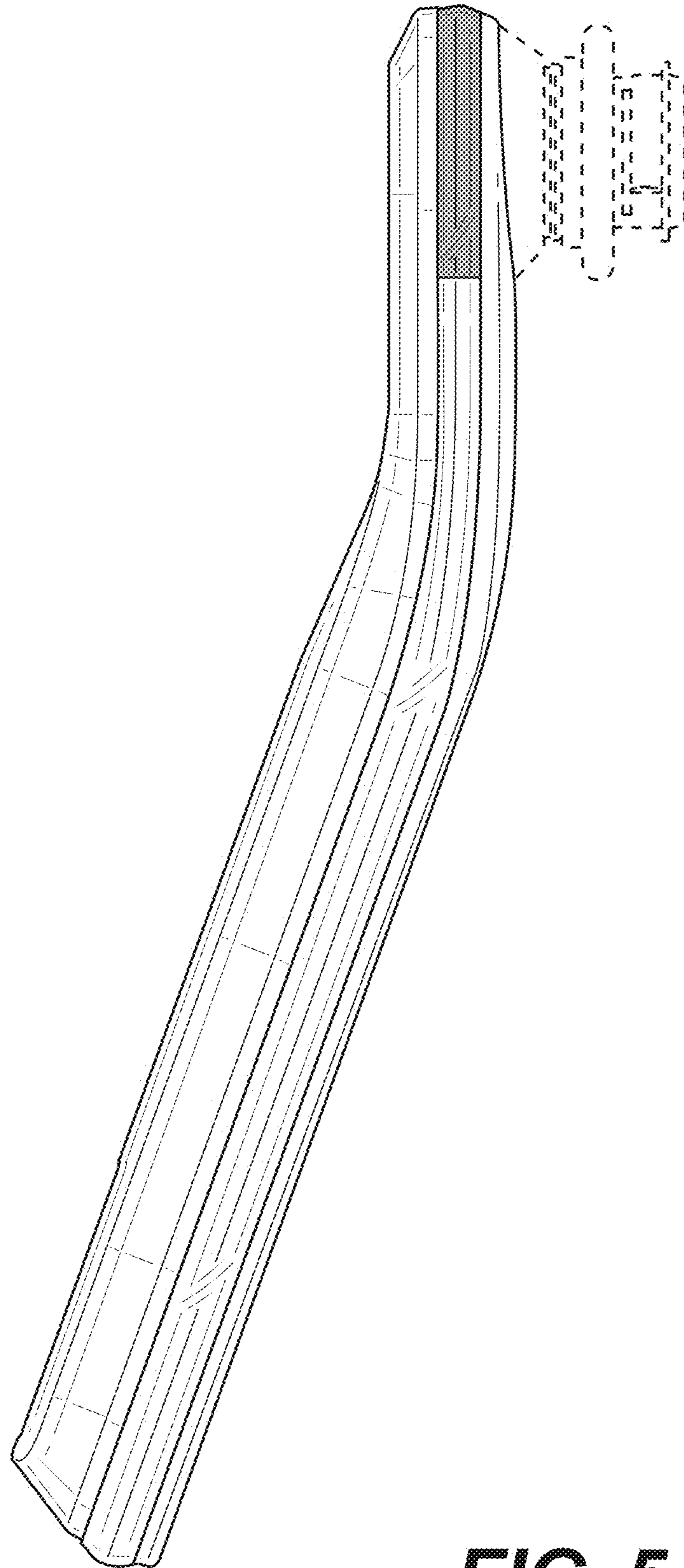

FIG. 5

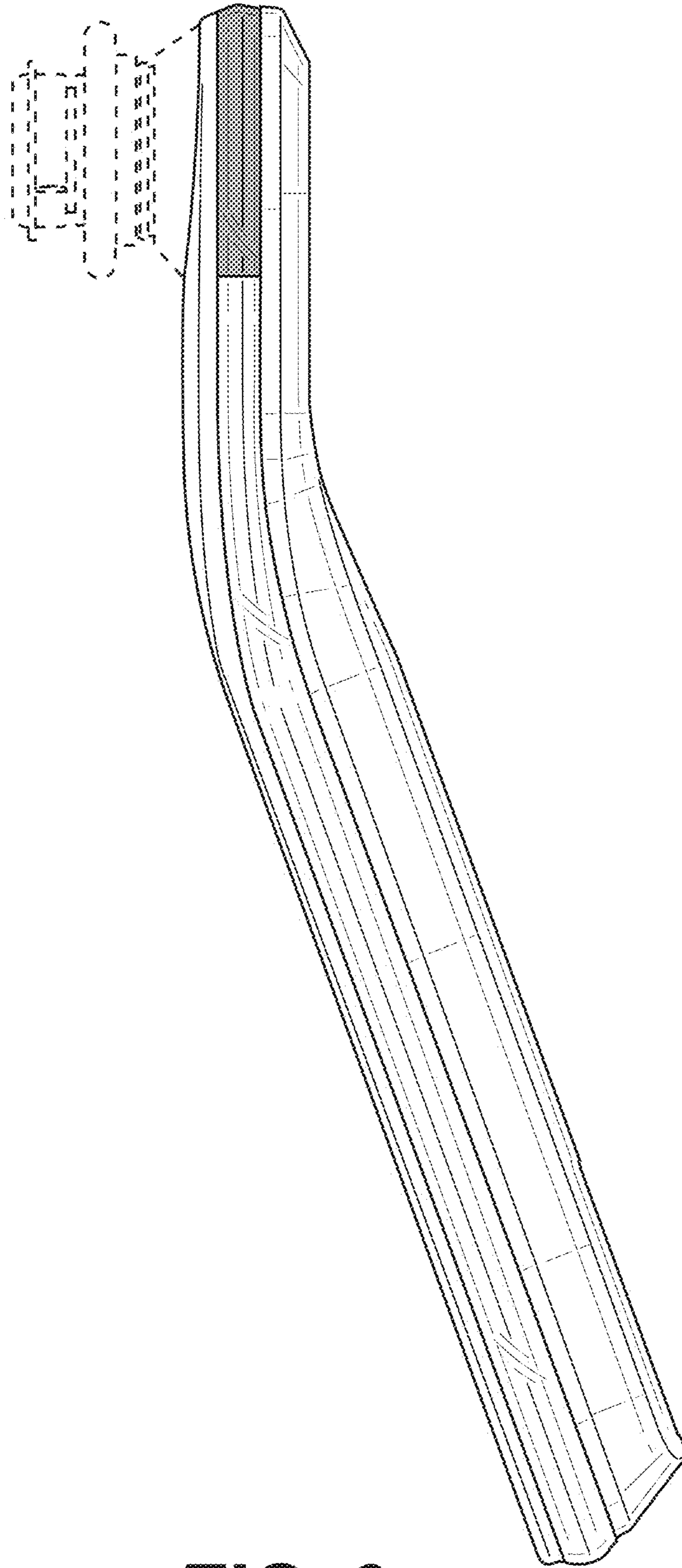

FIG. 6

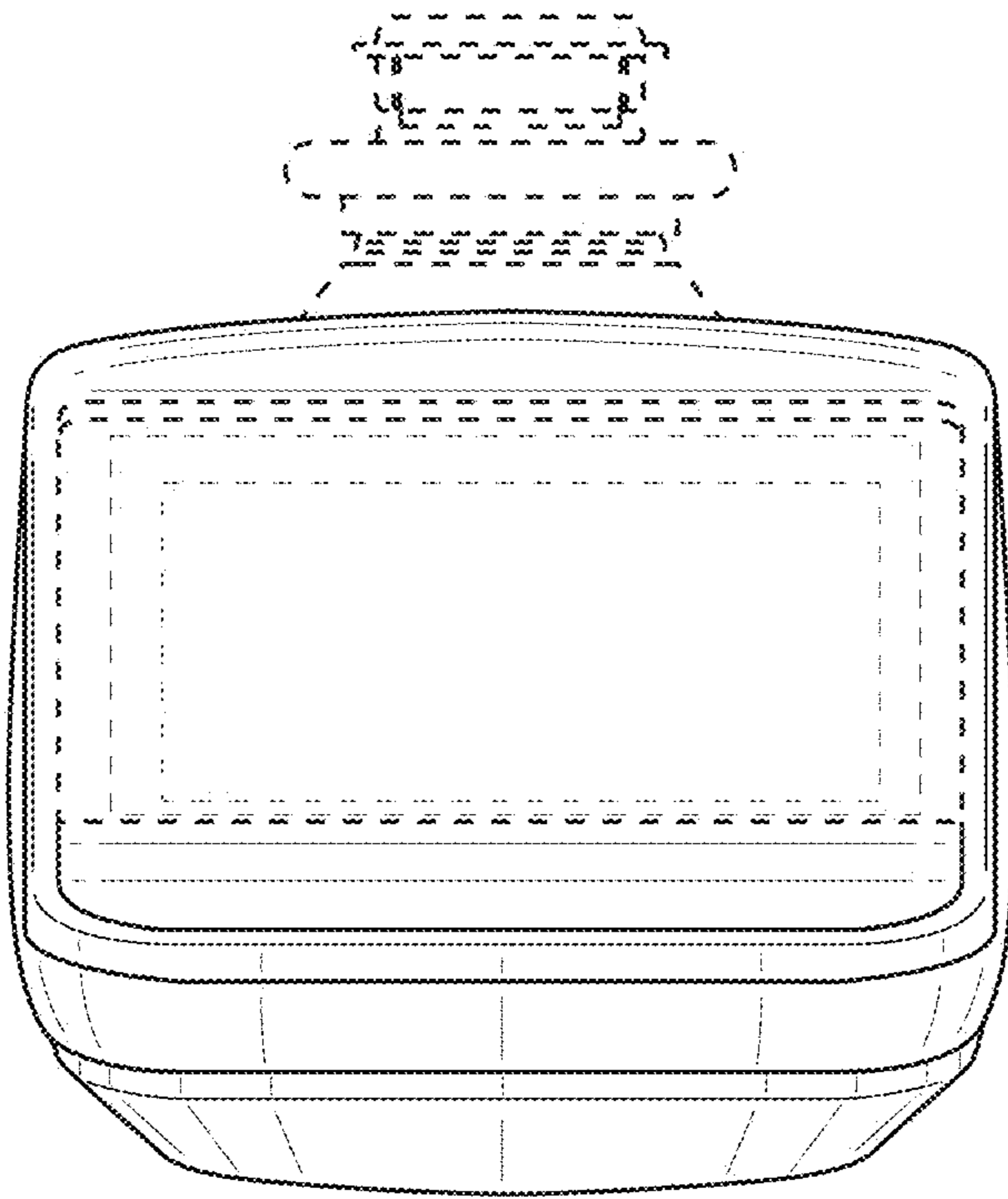

FIG. 7

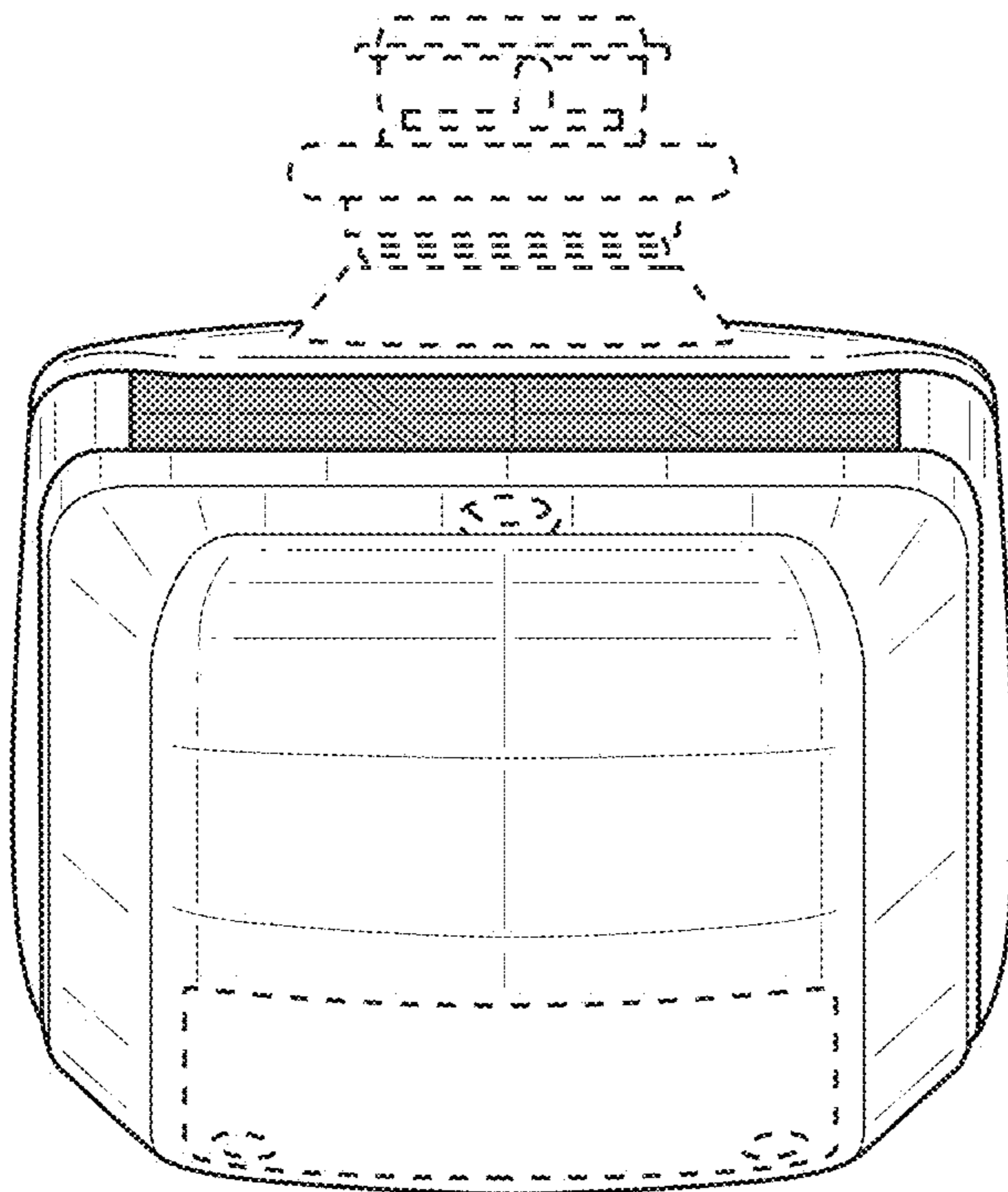

FIG. 8

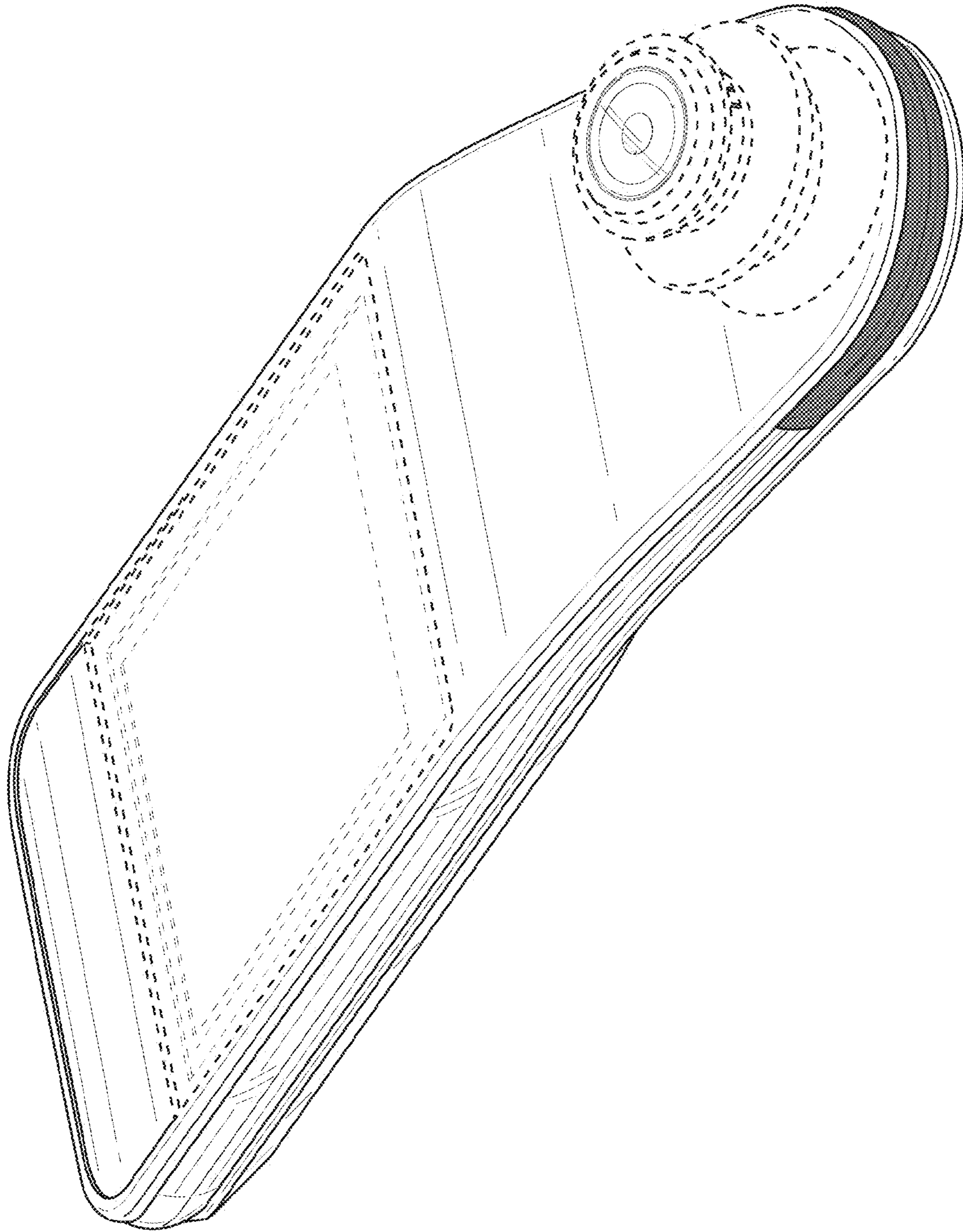

FIG. 9

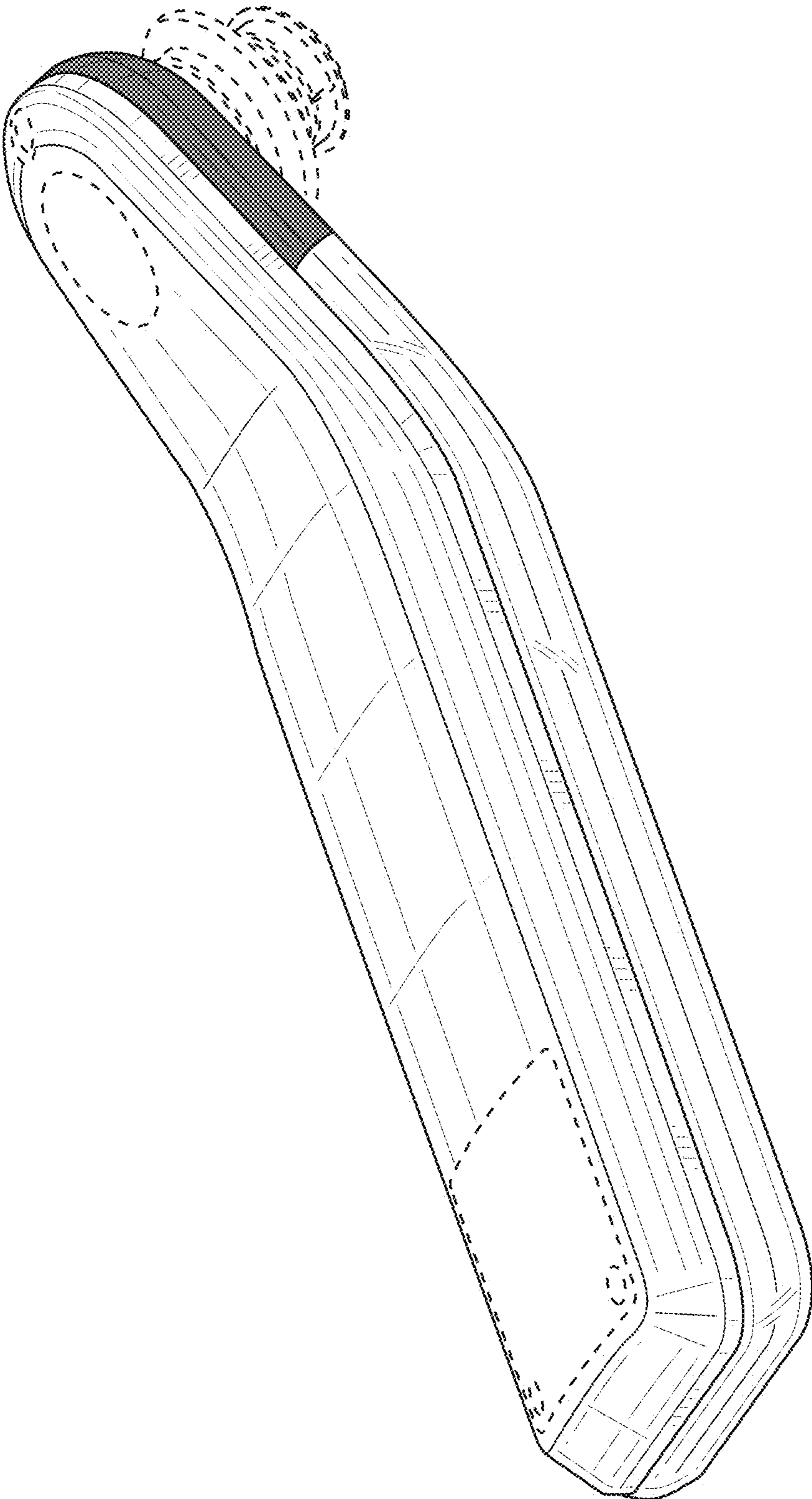

FIG. 10

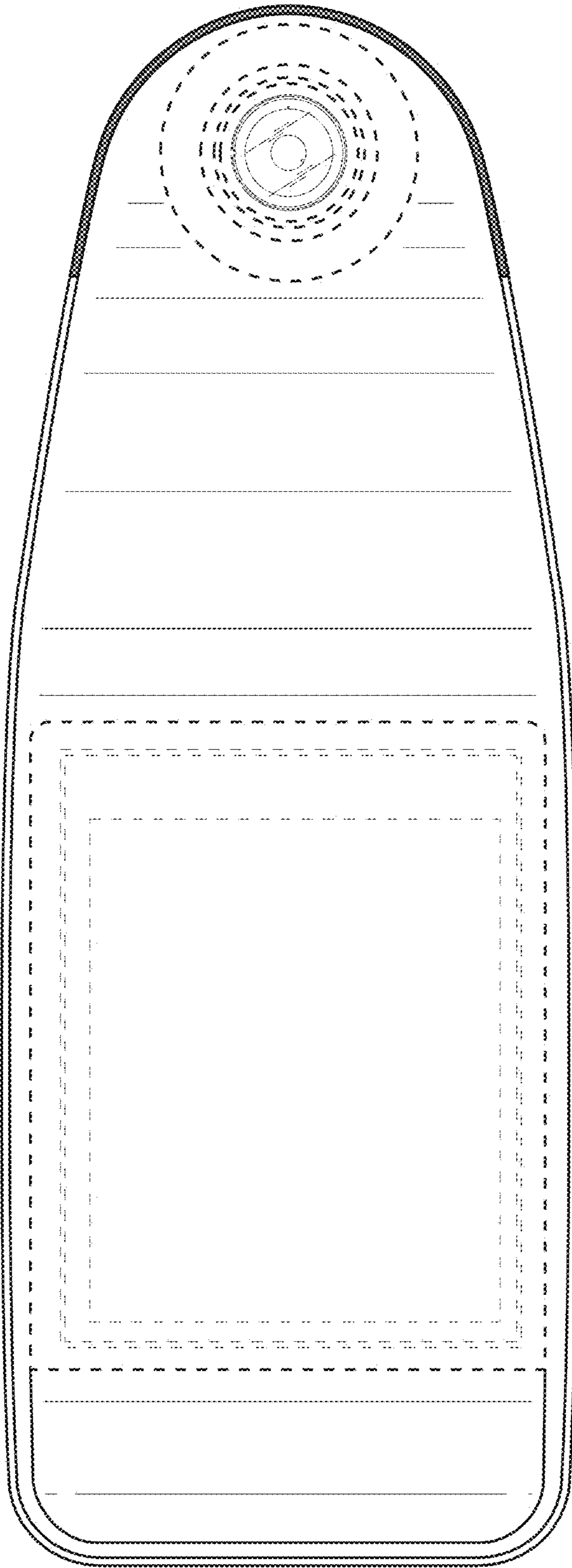

FIG. 11

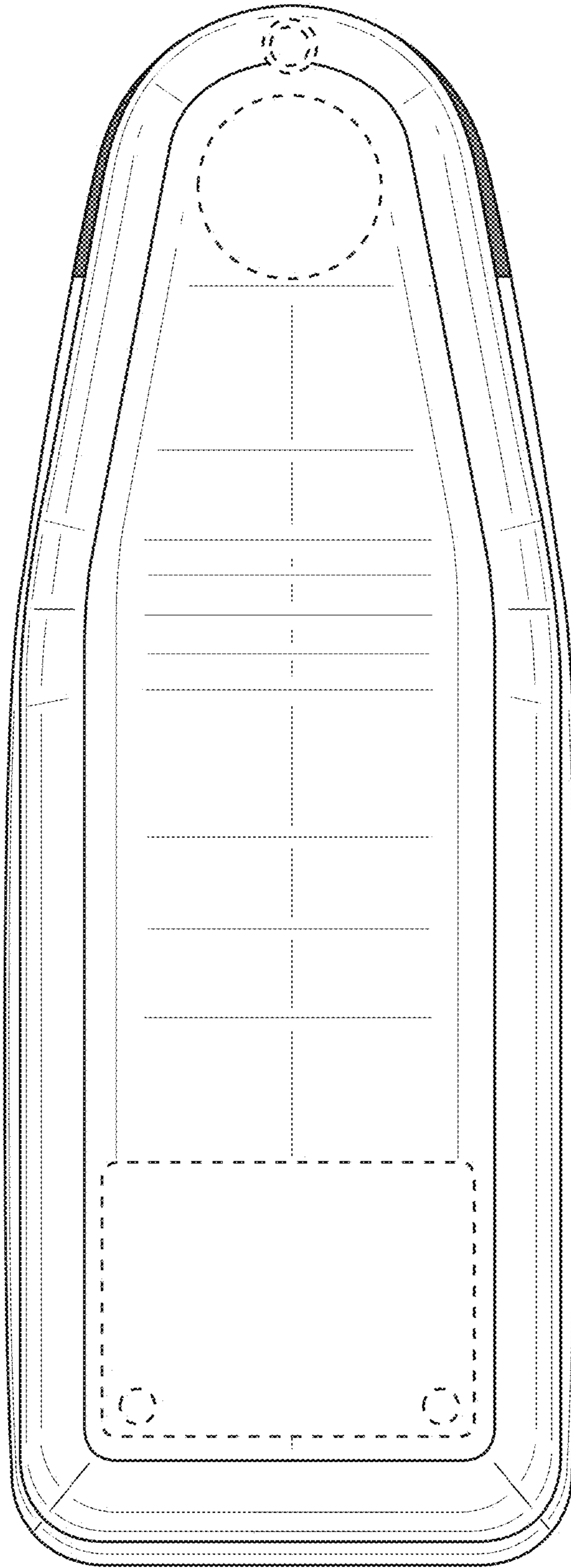

FIG. 12

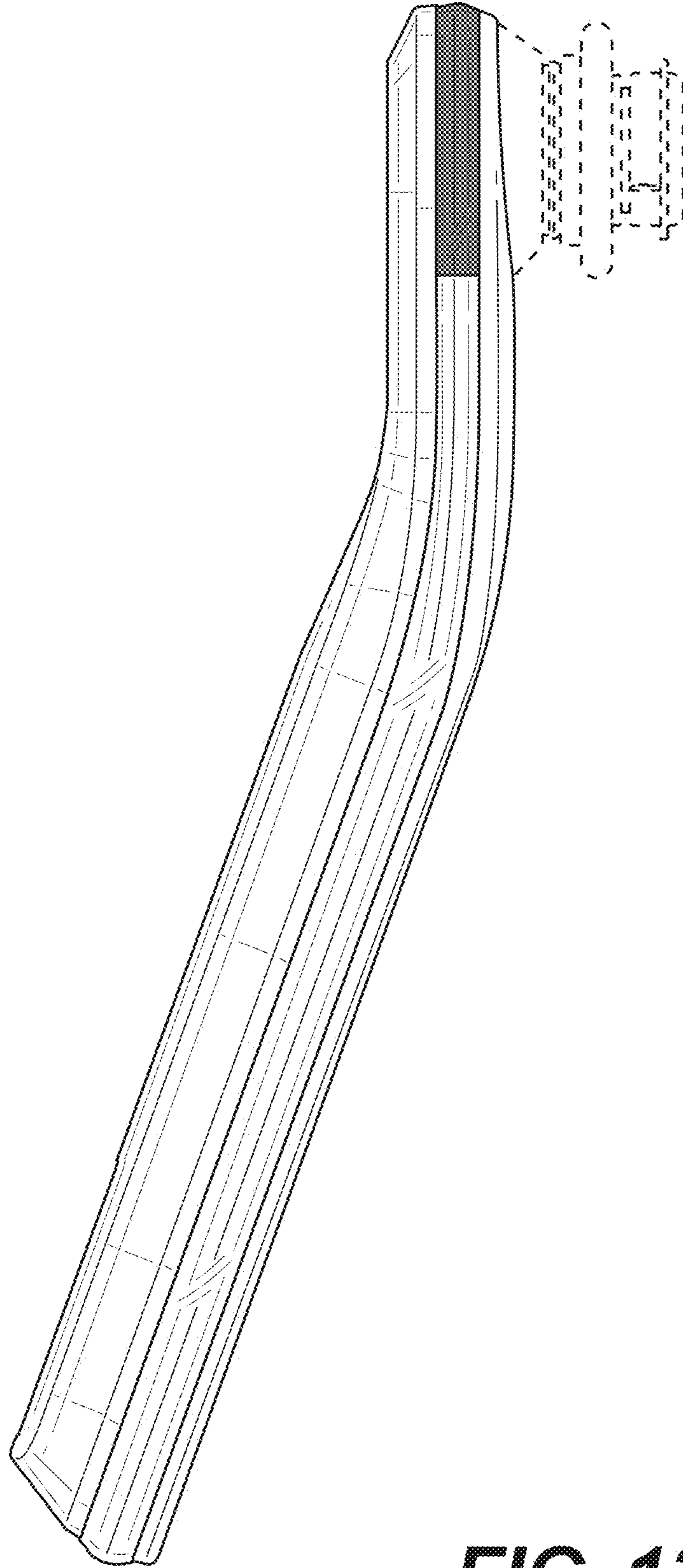

FIG. 13

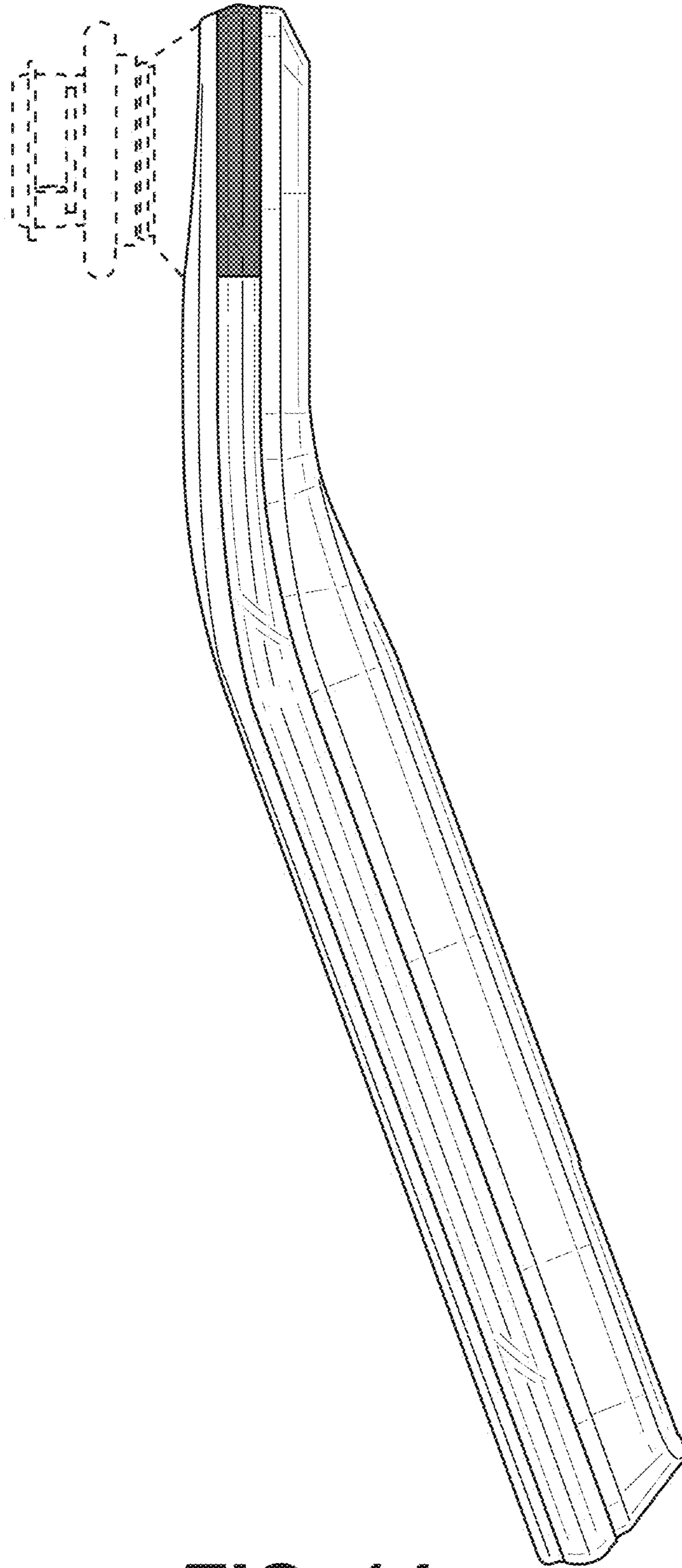

FIG. 14

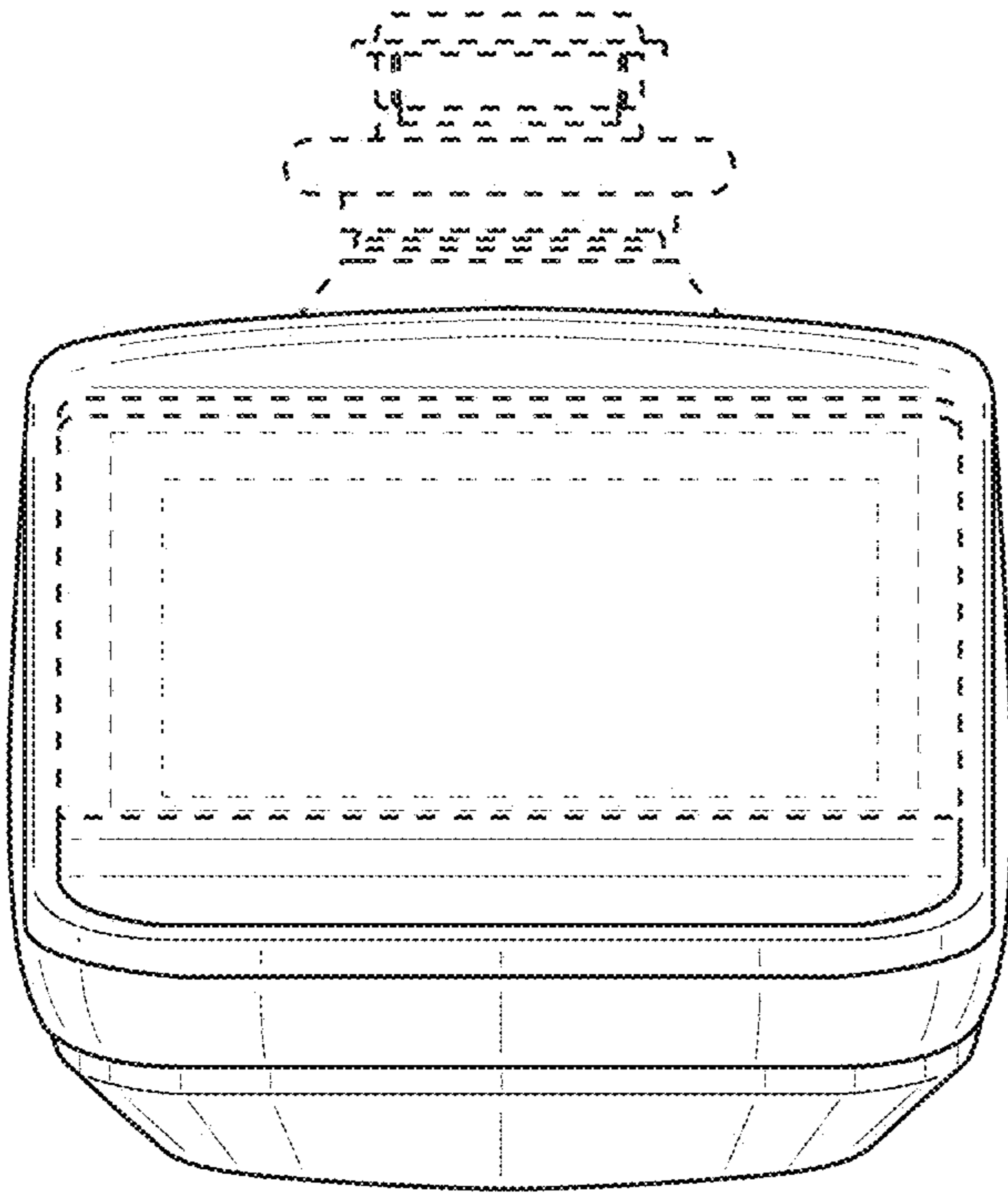

FIG. 15

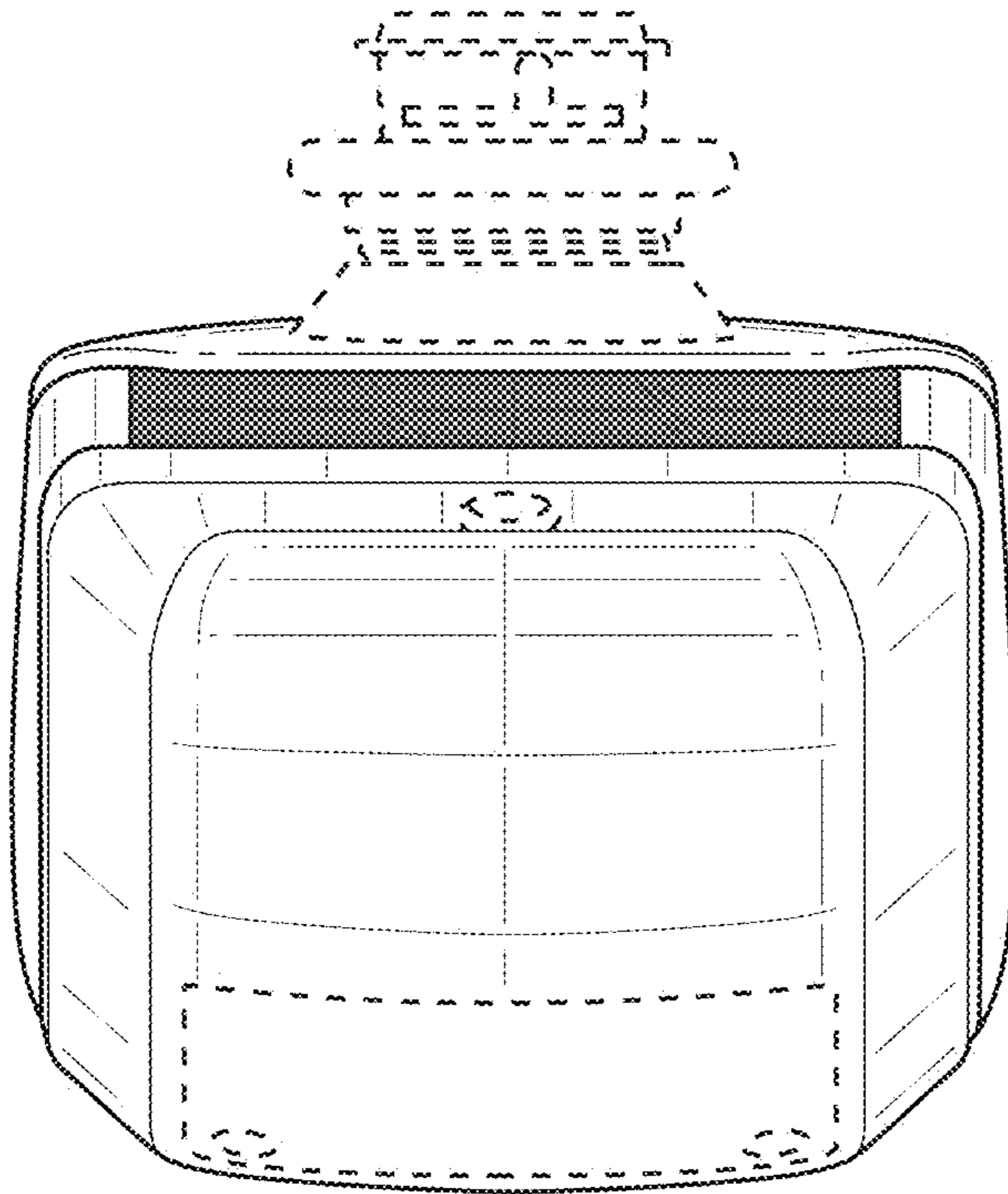

FIG. 16