



US00D897513S

(12) **United States Design Patent**
Huang

(10) **Patent No.:** **US D897,513 S**

(45) **Date of Patent:** **** Sep. 29, 2020**

- (54) **DIFFUSER AND HUMIDIFIER**
- (71) Applicant: **SHENZHEN VISION TECHNOLOGY CO., LTD**, Shenzhen (CN)
- (72) Inventor: **Xuepeng Huang**, Shanwei (CN)
- (73) Assignee: **SHENZHEN VISION TECHNOLOGY CO., LTD**, Shenzhen (CN)

D724,714 S *	3/2015	Benson	D23/332
D734,679 S *	7/2015	Liu	D10/53
D803,375 S *	11/2017	Wu	D23/366
D837,355 S *	1/2019	Gunnefur	D23/364
D855,784 S *	8/2019	Seo	D23/358
D860,424 S *	9/2019	Seo	D23/358
D869,629 S *	12/2019	Li	D23/366
D875,229 S *	2/2020	Clemmer	D23/366
D881,364 S *	4/2020	Li	D23/355
D882,744 S *	4/2020	Li	D23/355
D888,922 S *	6/2020	Zhong	D23/364

* cited by examiner

(**) Term: **15 Years**

Primary Examiner — David G Muller

(21) Appl. No.: **29/706,255**

(22) Filed: **Sep. 19, 2019**

(51) **LOC (12) Cl.** **23-04**

(52) **U.S. Cl.**
USPC **D23/356**

(58) **Field of Classification Search**
 USPC D23/355–366, 352, 369, 332, 333, 335,
 D23/336, 342, 351; 422/120, 122;
 55/356, 473, 504; 96/97; 261/DIG. 17,
 261/DIG. 65, DIG. 88, DIG. 31
 CPC .. A61L 9/16; A61L 9/22; B01D 47/00; B01D
 47/027; B01D 2221/02; B01D 2259/4508;
 B03C 3/155; B03C 3/368; F24F 3/16;
 F24F 13/20; F24F 13/28; F24F
 2001/0096

See application file for complete search history.

(56) **References Cited**

U.S. PATENT DOCUMENTS

D653,744 S *	2/2012	Li	D23/366
D665,893 S *	8/2012	Li	D23/366

(57) **CLAIM**

The ornamental design for a diffuser and humidifier, as shown and described.

DESCRIPTION

FIG. 1 is a perspective view of a diffuser and humidifier showing my new design;
 FIG. 2 is another perspective view thereof;
 FIG. 3 is a front elevational view thereof;
 FIG. 4 is a rear elevational view thereof;
 FIG. 5 is a left side elevational view thereof;
 FIG. 6 is a right side elevational view thereof;
 FIG. 7 is a top plan view thereof;
 FIG. 8 is a bottom plan view thereof; and,
 FIG. 9 is an enlarged view of portion 9 shown in FIG. 1.
 The broken lines in the drawings depict portions of the diffuser and humidifier that form no part of the claimed design.

1 Claim, 9 Drawing Sheets

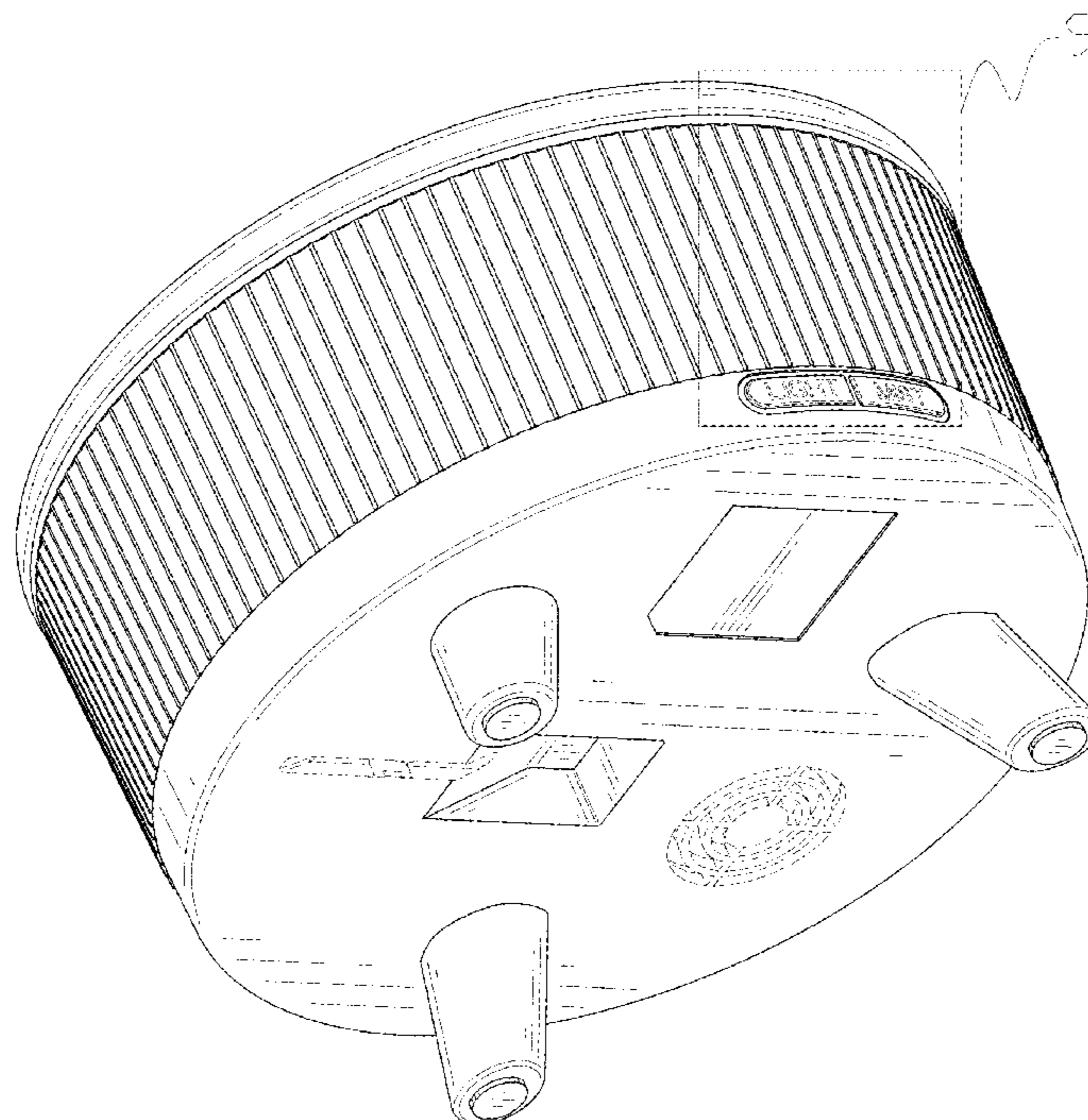

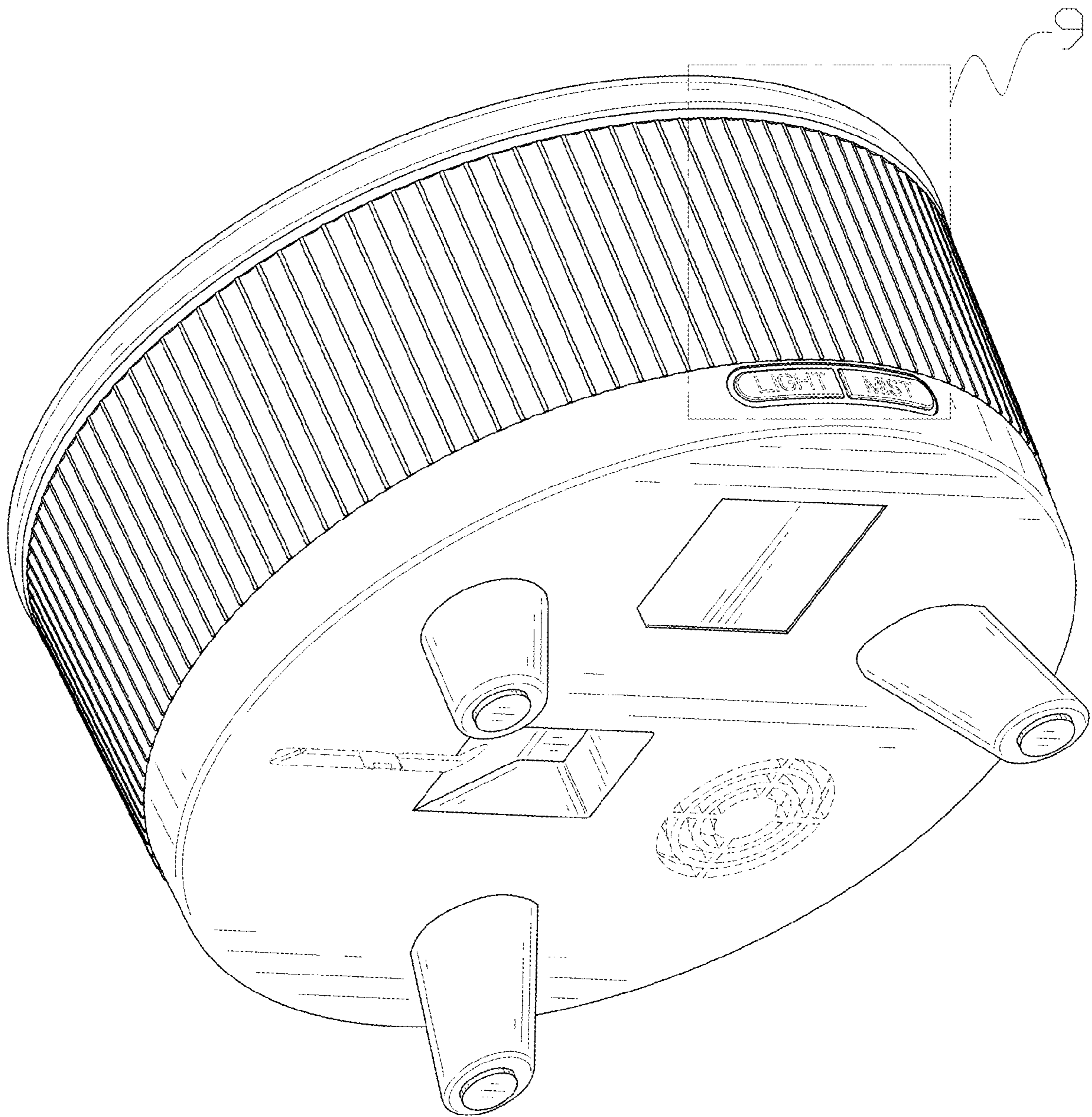

FIG. 1

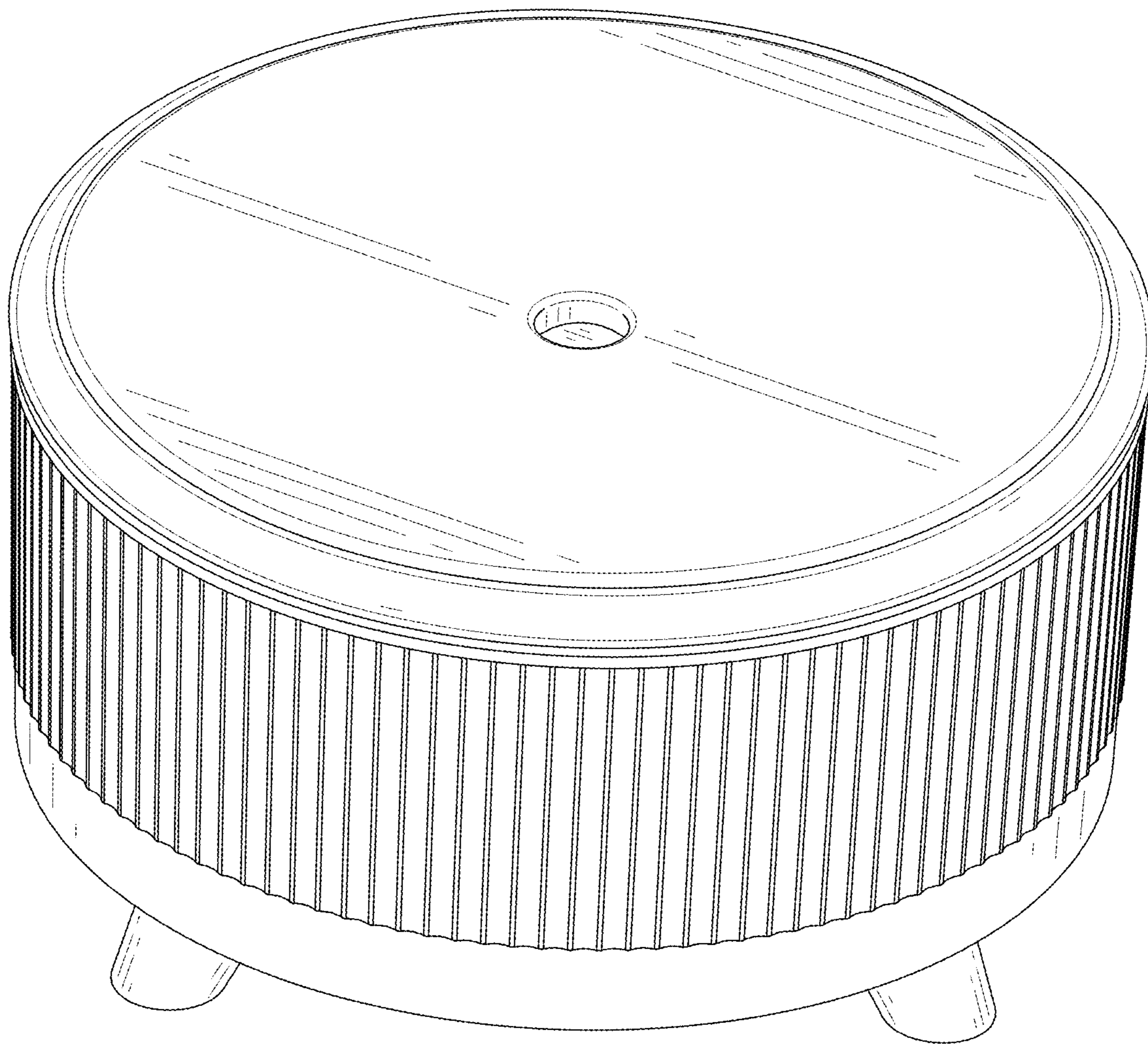

FIG. 2

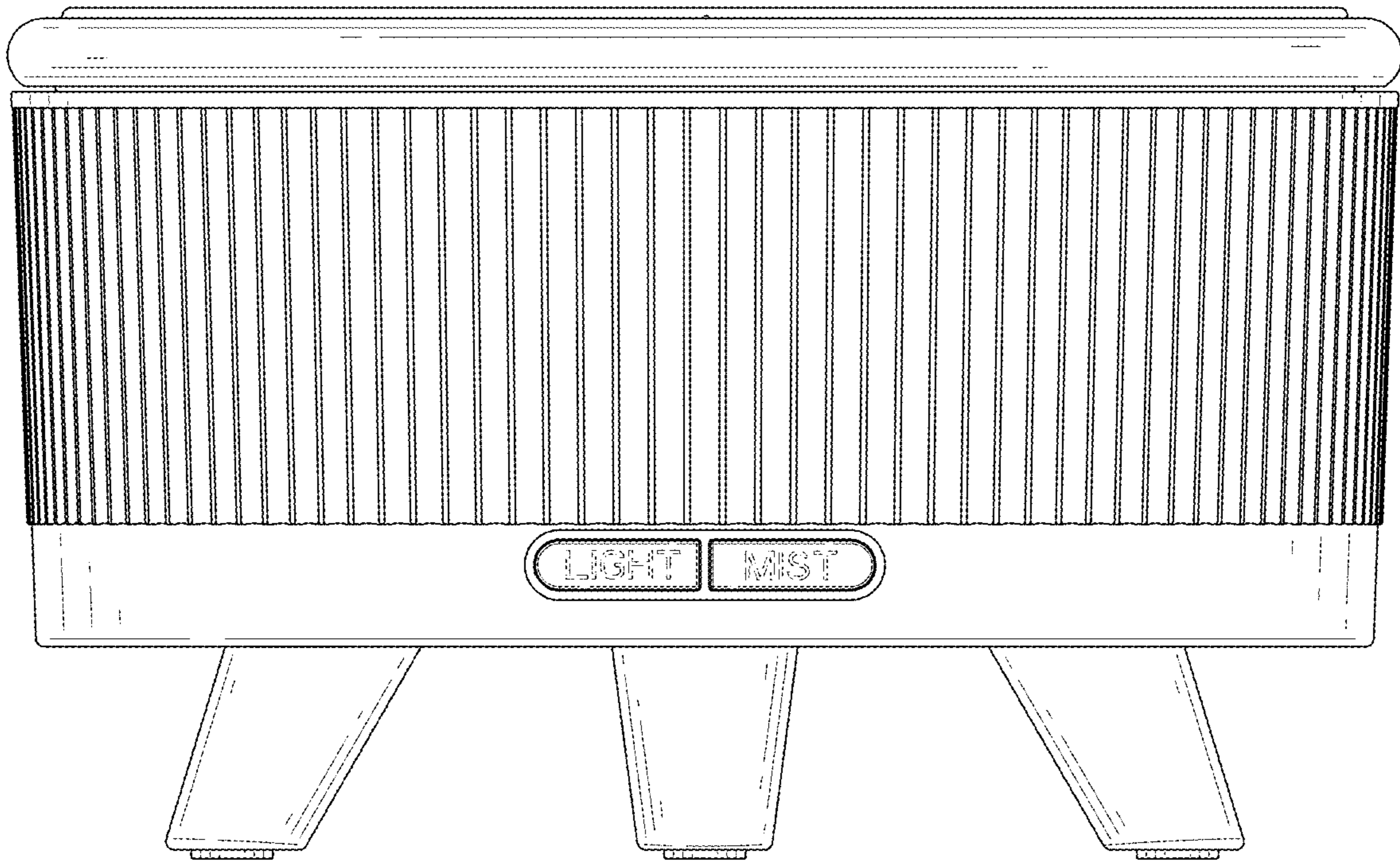

FIG. 3

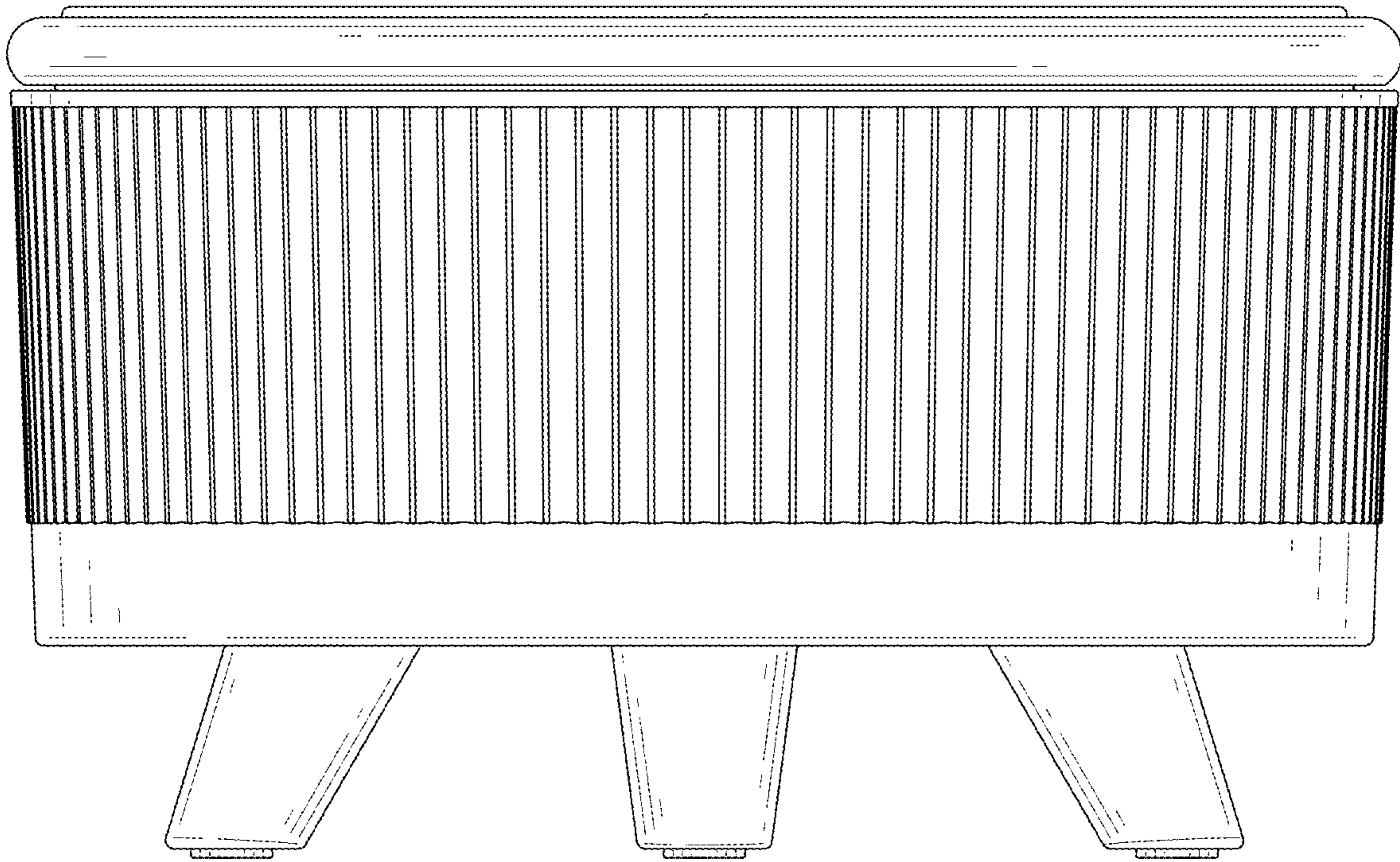

FIG. 4

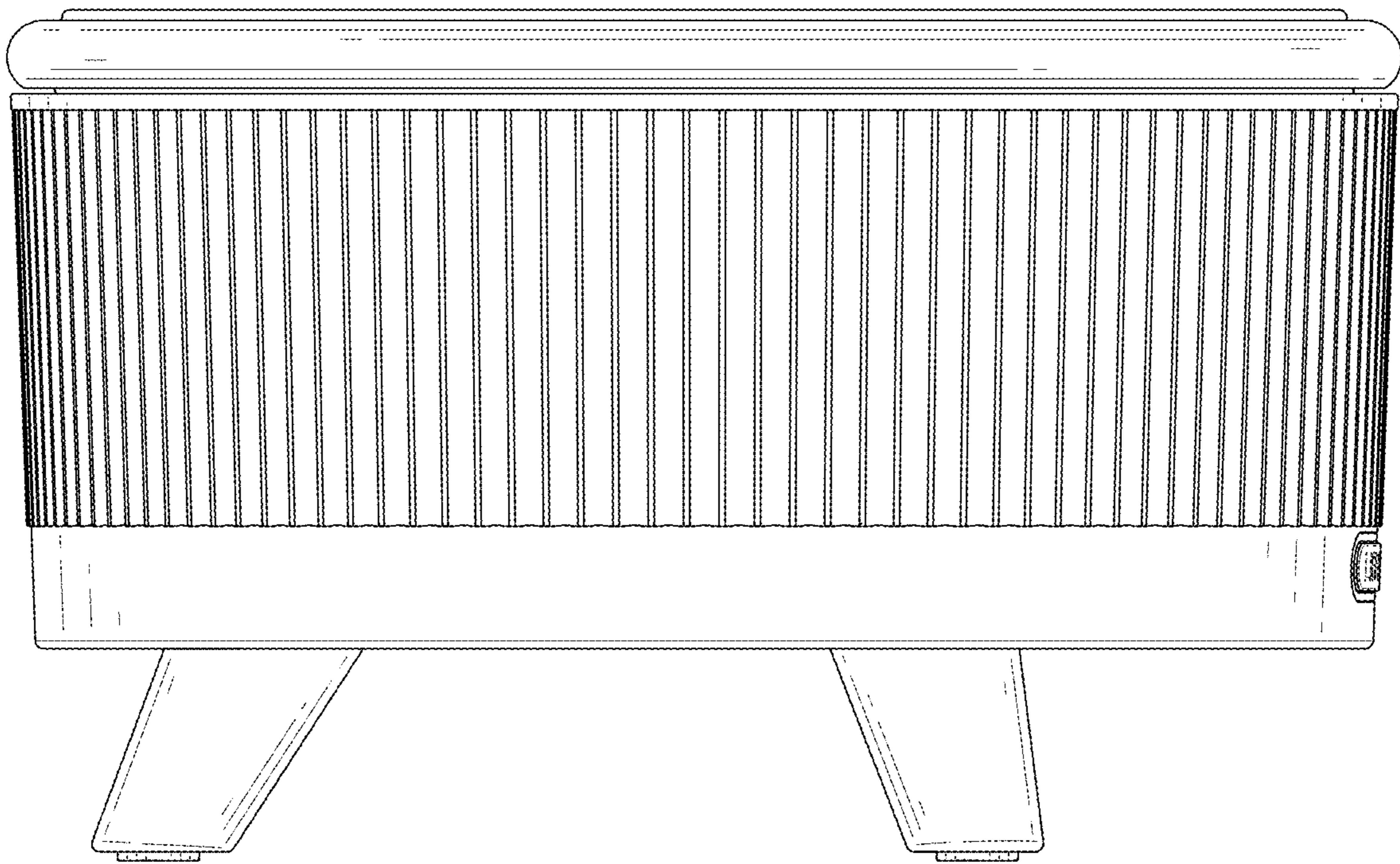

FIG. 5

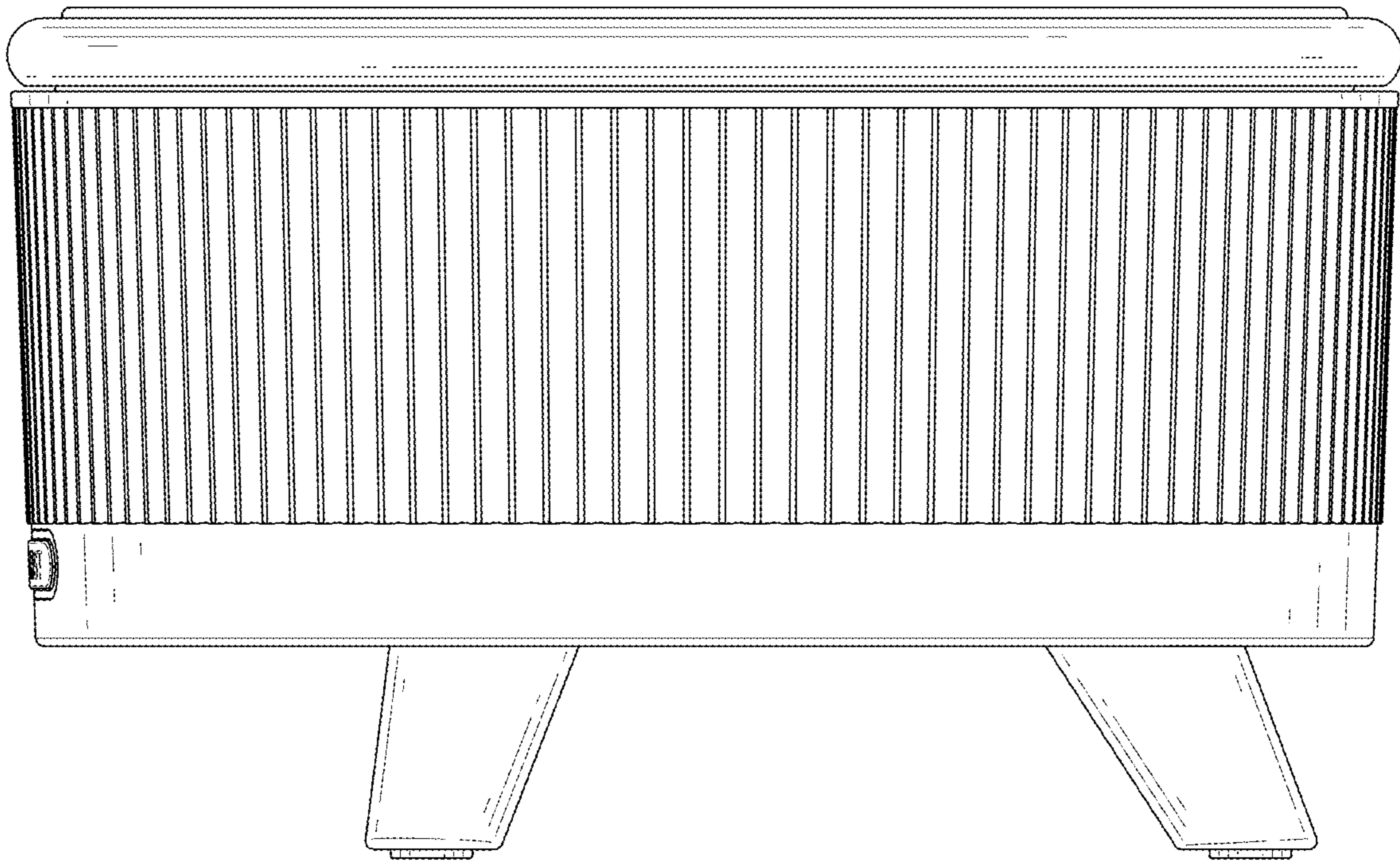

FIG. 6

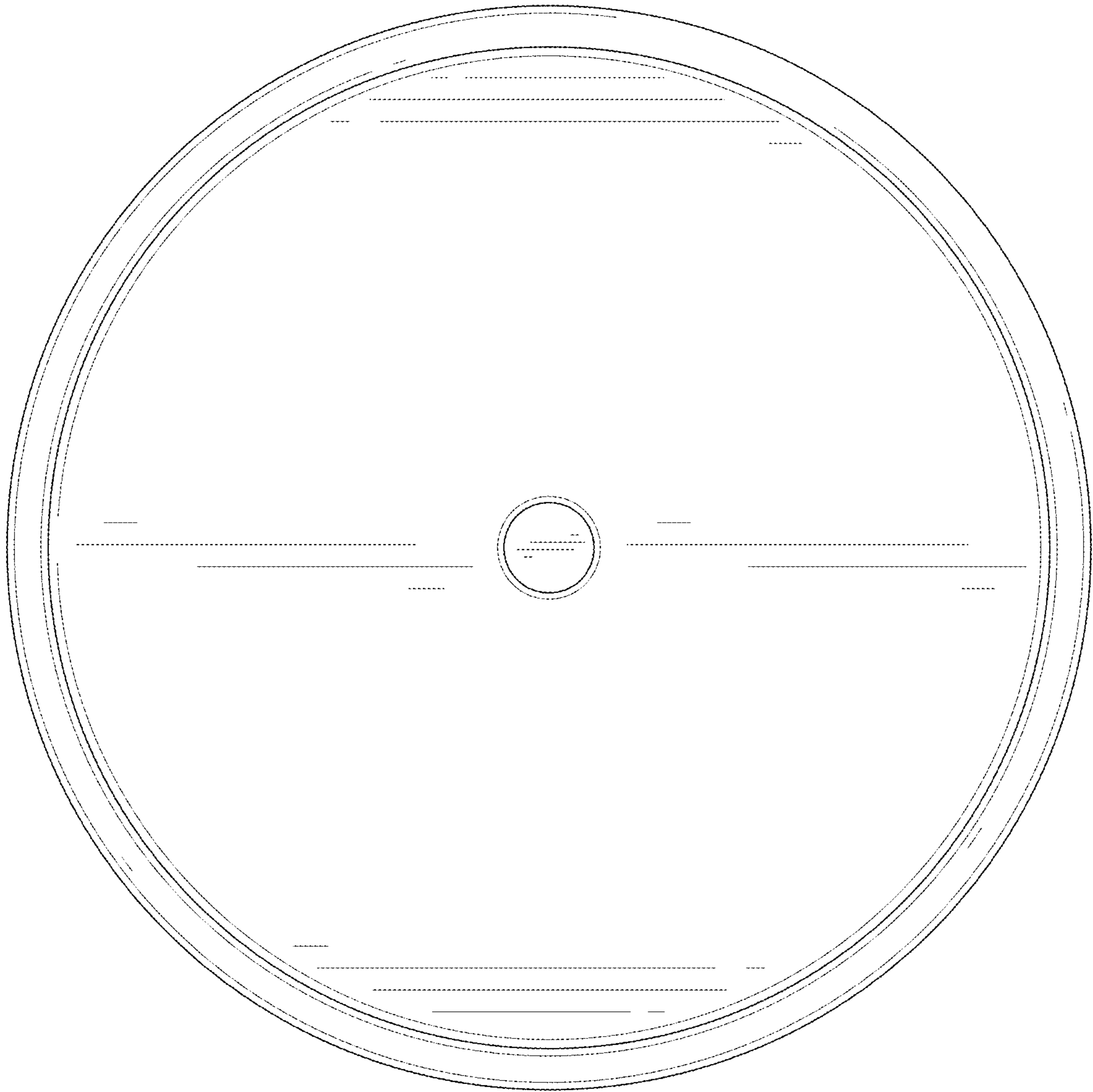

FIG. 7

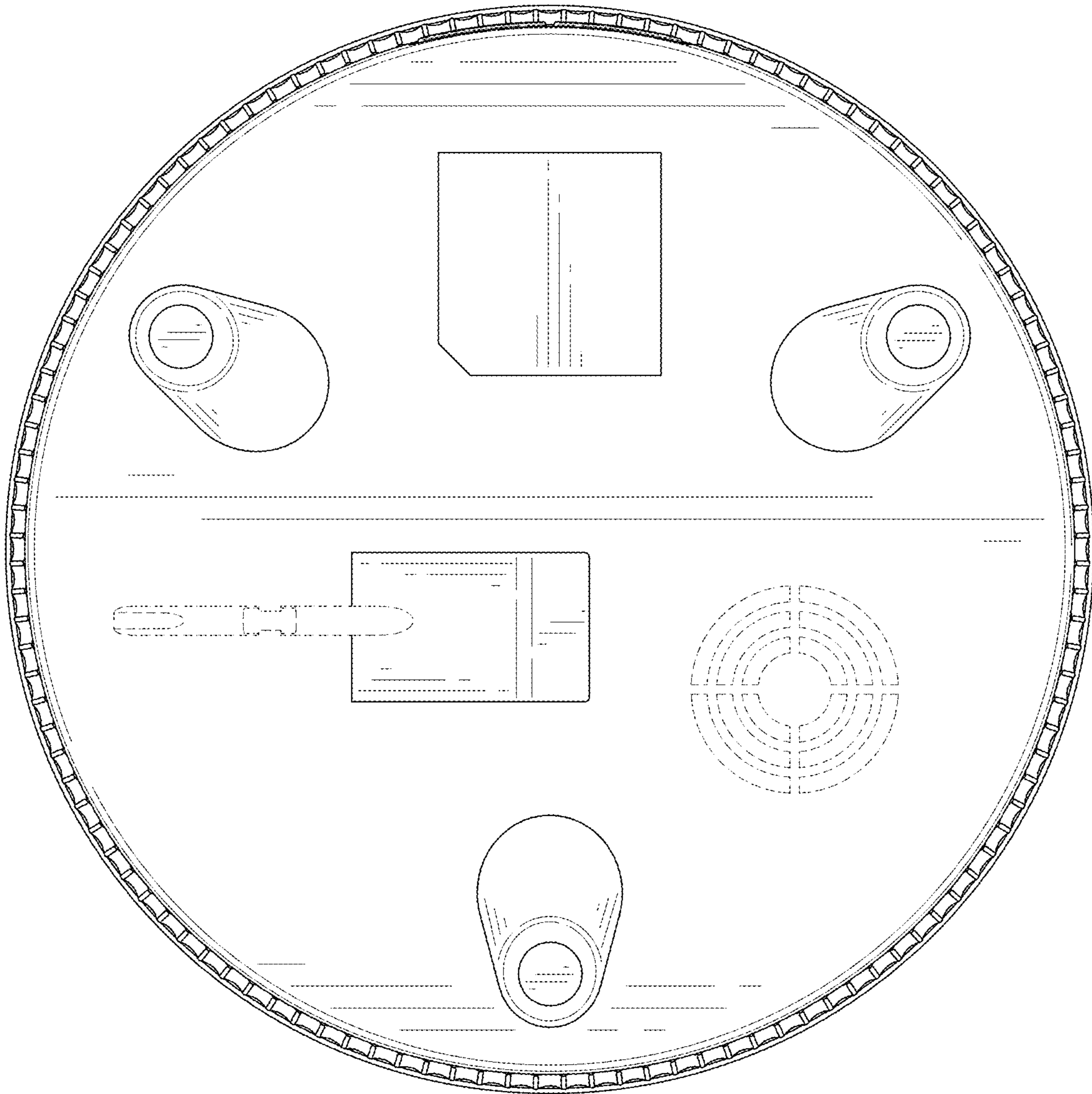

FIG. 8

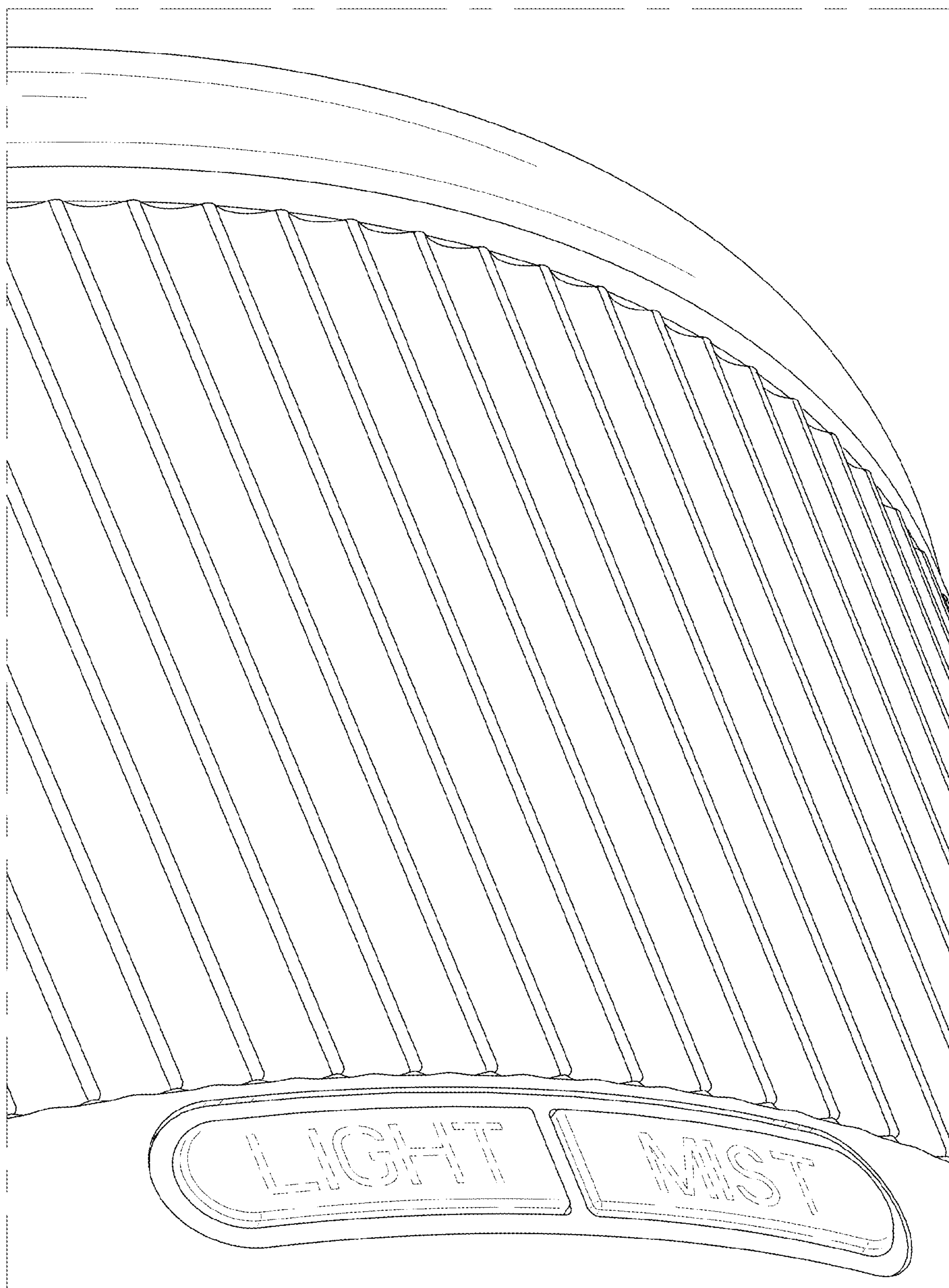

FIG. 9