



US00D897462S

(12) **United States Design Patent**  
**Parsons et al.**

(10) **Patent No.:** **US D897,462 S**  
(45) **Date of Patent:** **\*\* Sep. 29, 2020**

- (54) **GOLF CLUB HEAD**
- (71) Applicant: **PARSONS XTREME GOLF, LLC**,  
Scottsdale, AZ (US)
- (72) Inventors: **Robert R. Parsons**, Scottsdale, AZ  
(US); **Bradley D. Schweigert**, Anthem,  
AZ (US); **Michael R. Nicolette**,  
Scottsdale, AZ (US); **Caleb S. Kroloff**,  
Phoenix, AZ (US)
- (73) Assignee: **PARSONS XTREME GOLF, LLC**,  
Scottsdale, AZ (US)
- (\*\*) Term: **15 Years**
- (21) Appl. No.: **29/682,918**
- (22) Filed: **Mar. 8, 2019**

**Related U.S. Application Data**

- (63) Continuation-in-part of application No. 29/669,944,  
filed on Nov. 13, 2018, now abandoned, and a  
continuation-in-part of application No. 29/665,649,  
filed on Oct. 5, 2018, now abandoned, and a  
continuation-in-part of application No. 29/674,360,  
filed on Dec. 20, 2018, now abandoned.
- (51) **LOC (12) Cl.** ..... **21-02**
- (52) **U.S. Cl.**  
USPC ..... **D21/752**
- (58) **Field of Classification Search**  
USPC ..... D21/733, 752, 759  
CPC ..... A63B 53/00; A63B 53/04; A63B 53/0466;  
A63B 2053/002; A63B 2053/0445; A63B  
2053/0433; A63B 2053/0491; A63B  
2053/0437; A63B 60/00; A63B 60/46  
See application file for complete search history.

(56) **References Cited**

**U.S. PATENT DOCUMENTS**

1,133,129 A 3/1915 Govan  
1,269,745 A 6/1918 Robertson  
1,306,029 A 6/1919 Robertson

D55,867 S 7/1920 Mattern  
1,509,429 A 9/1924 Hillerich  
1,534,600 A \* 4/1925 Mattern ..... A63B 53/08  
473/337  
1,538,312 A 5/1925 Beat  
1,543,691 A 6/1925 Beat  
1,774,590 A 9/1930 Buhrke  
D94,549 S 2/1935 Jansky  
D94,550 S 2/1935 Jansky  
D136,437 S 8/1944 Link  
D138,437 S \* 8/1944 Link ..... D21/752  
D138,438 S 8/1944 Link  
D138,439 S 8/1944 Link  
D138,441 S 8/1944 Link  
D138,442 S 8/1944 Link  
D164,469 S 9/1951 Behrendt  
D185,177 S 5/1959 Smith  
3,020,048 A 2/1962 Carroll  
D203,936 S 3/1966 Long  
D215,101 S 9/1969 Sabat  
3,556,553 A 1/1971 Kolbe  
3,652,094 A 3/1972 Glover  
D229,431 S 11/1973 Baker  
D234,609 S 3/1975 Raymont  
D234,610 S 3/1975 Raymont  
D234,963 S 4/1975 Hirata  
D239,550 S 4/1976 Timbrook  
D240,054 S 5/1976 Meissler  
D240,748 S 7/1976 Bock  
D241,956 S 10/1976 Timbrook  
4,085,934 A 4/1978 Churchward  
D253,778 S \* 12/1979 Madison ..... D21/752  
D261,167 S 10/1981 Swanson  
4,332,388 A 6/1982 Crow  
D285,954 S 9/1986 Hasegawa  
D294,617 S 3/1988 Perkins  
4,754,977 A 7/1988 Sahn  
4,824,116 A 4/1989 Nagamoto  
D307,783 S 5/1990 Iinuma  
4,988,104 A 1/1991 Shiotani  
D326,885 S 6/1992 Paul  
5,158,296 A 10/1992 Lee  
5,176,384 A 1/1993 Sata  
5,213,328 A 5/1993 Long  
5,213,329 A 5/1993 Okumoto  
D336,672 S 6/1993 Gorman  
D338,935 S 8/1993 Antonious  
D344,561 S 2/1994 Gorman  
D351,883 S \* 10/1994 Solheim ..... D21/752  
D353,862 S 12/1994 Saito  
D357,520 S 4/1995 Schmidt  
5,419,560 A 5/1995 Bamber  
5,425,535 A 6/1995 Gee

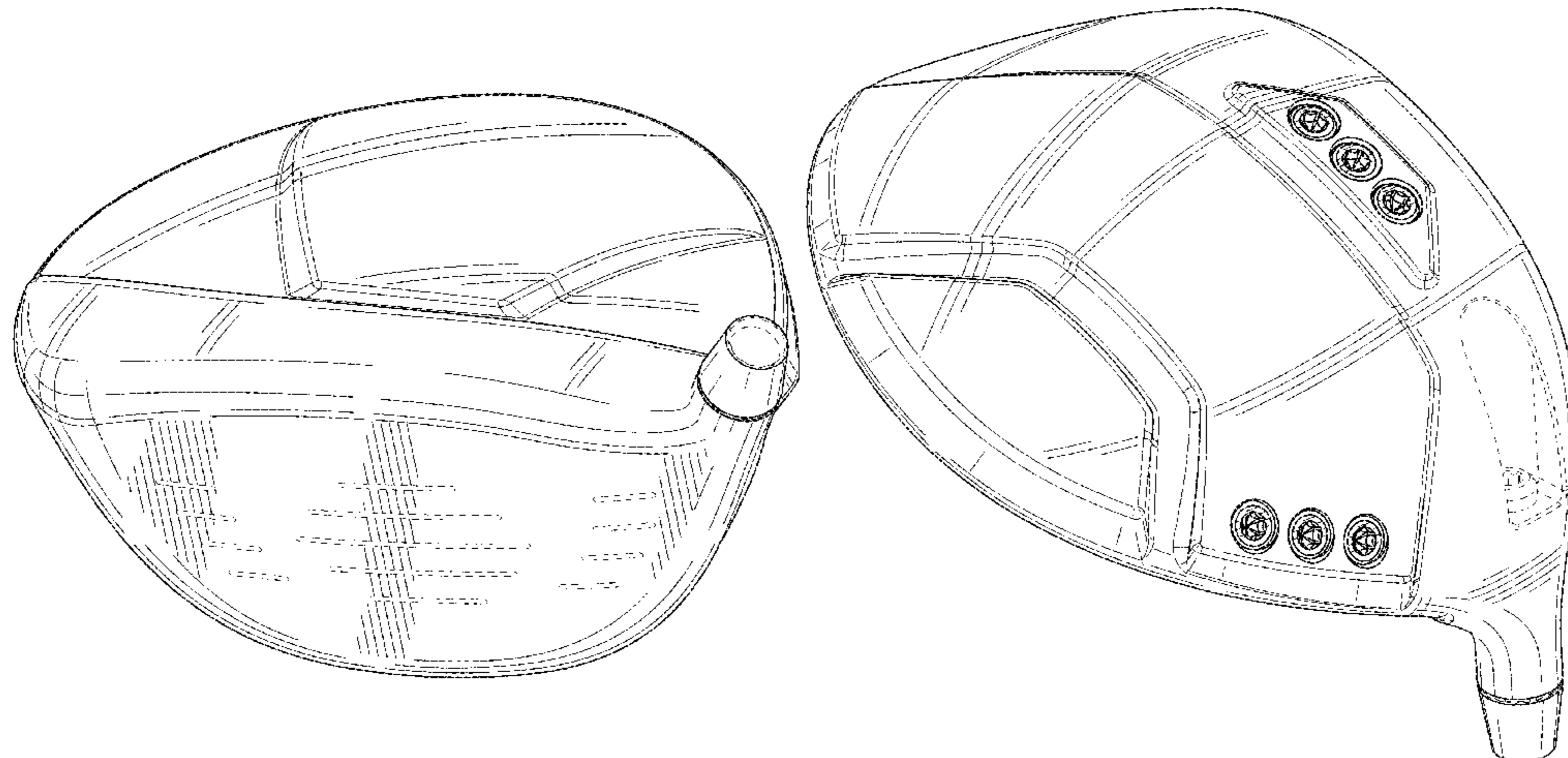

# US D897,462 S

D361,358 S	8/1995	Simmons		D524,889 S	7/2006	Kim
5,447,311 A	9/1995	Viollaz		D526,372 S	8/2006	Kohno
5,451,056 A	9/1995	Manning		D526,694 S	8/2006	Jertson
D362,884 S	10/1995	Sheeley		7,121,956 B2	10/2006	Lo
D362,885 S	10/1995	Sheeley		7,128,663 B2	10/2006	Bamber
D362,887 S	10/1995	Sheeley		D534,595 S	1/2007	Hasebe
5,518,243 A *	5/1996	Redman	..... A63B 53/04	D534,599 S	1/2007	Beach
			473/334	7,156,751 B2	1/2007	Wahl
D370,514 S	6/1996	Sheeley		7,166,040 B2	1/2007	Hoffman
D371,816 S	7/1996	Yoshioka		D536,401 S	2/2007	Kawami
5,540,437 A	7/1996	Bamber		D536,402 S	2/2007	Kawami
D378,111 S	2/1997	Parente		D536,403 S	2/2007	Kawami
5,637,045 A	6/1997	Igarashi		D537,495 S	2/2007	Nicolette
D384,120 S	9/1997	Parente		7,182,698 B2	2/2007	Tseng
5,669,830 A	9/1997	Bamber		D538,363 S	3/2007	Nicolette
D389,541 S	1/1998	Huan-Chiang		D538,371 S	3/2007	Kawami
D395,476 S	6/1998	Pond et al.		7,186,190 B1	3/2007	Beach
5,766,091 A	6/1998	Humphrey		7,207,900 B2	4/2007	Nicolette
5,766,092 A	6/1998	Mimeur		D543,601 S	5/2007	Kawami
5,788,564 A	8/1998	Parente		7,223,180 B2	5/2007	Willett
D399,277 S	10/1998	Ezaki		D552,198 S	10/2007	Nicolette
5,827,132 A	10/1998	Bamber		D555,219 S	11/2007	Lin
D400,625 S	11/1998	Nicolette		D557,363 S	12/2007	Serrano
D400,627 S	11/1998	Nicolette		D558,287 S	12/2007	Serrano
D405,489 S	2/1999	Nicolette		D558,288 S	12/2007	Serrano
D405,492 S	2/1999	Nicolette		7,303,486 B2	12/2007	Imamoto
D408,485 S	4/1999	Sasaki		D559,932 S	1/2008	Belmont
5,899,821 A	5/1999	Hsu		D561,284 S	2/2008	Nagai
5,935,016 A	8/1999	Antonious		D562,421 S	2/2008	Serrano
D414,535 S	9/1999	Mertens		D563,498 S	3/2008	Jertson
D421,080 S	2/2000	Chen		D564,054 S	3/2008	Jertson
D426,276 S	6/2000	Besnard et al.		D564,055 S	3/2008	Jertson
6,077,171 A	6/2000	Yoneyama		7,338,388 B2	3/2008	Schweigert
D442,659 S	5/2001	Solheim		7,347,794 B2	3/2008	Schweigert
D443,008 S	5/2001	Kubica		D567,317 S	4/2008	Jertson et al.
D444,830 S	7/2001	Nicolette		7,351,164 B2	4/2008	Schweigert
D445,862 S	7/2001	Ford		D569,933 S	5/2008	Jertson
6,290,609 B1	9/2001	Takeda		D569,934 S	5/2008	Jertson et al.
D448,824 S	10/2001	Koizumi et al.		D569,935 S	5/2008	Chen
D449,866 S	10/2001	Miller		D569,936 S	5/2008	Chen
D457,211 S	5/2002	Bakke		D569,942 S	5/2008	Jertson
D469,833 S	2/2003	Roberts		D570,937 S	6/2008	Chen
D473,604 S	4/2003	Antonious		D570,938 S	6/2008	Jertson
D473,605 S	4/2003	Petersen		7,407,447 B2	6/2008	Beach
D475,107 S	5/2003	Madore		7,396,299 B2	7/2008	Nicolette
D476,048 S	6/2003	Cleveland		7,410,425 B2	8/2008	Willett
D476,949 S	8/2003	De La Cruz		7,410,426 B2	8/2008	Willett
D478,140 S	8/2003	Burrows		7,419,441 B2	9/2008	Hoffman
D481,087 S	10/2003	Antonious		D579,507 S	10/2008	Llewellyn
6,638,182 B2	10/2003	Kosmatka		7,448,963 B2	11/2008	Beach
6,695,714 B1	2/2004	Bliss		7,448,964 B2	11/2008	Schweigert
6,702,693 B2	3/2004	Bamber		D584,370 S	1/2009	Cleveland
6,773,360 B2	8/2004	Willett		7,530,904 B2	5/2009	Beach
6,780,123 B2	8/2004	Hasebe		D594,518 S	6/2009	Schweigert
D497,963 S	11/2004	Toulon		D594,520 S	6/2009	Chen
6,811,496 B2	11/2004	Wahl		D594,521 S	6/2009	Jertson
D499,779 S	12/2004	Mahaffey		D594,919 S	6/2009	Chen
D502,975 S	3/2005	Schweigert et al.		7,540,811 B2	6/2009	Beach
D503,204 S	3/2005	Nicolette et al.		D597,620 S	8/2009	Toulon
D507,320 S	7/2005	Roberts et al.		7,568,985 B2	8/2009	Beach
D508,545 S	8/2005	Roberts et al.		7,578,753 B2	8/2009	Beach
D508,969 S	8/2005	Hasebe		D600,297 S	9/2009	Jertson
6,923,733 B2	8/2005	Chen		7,584,531 B2	9/2009	Schweigert
6,939,247 B1	9/2005	Schweigert		7,588,502 B2	9/2009	Nishino
D513,051 S	12/2005	Lorenz, Jr.		7,591,738 B2	9/2009	Beach
D514,179 S	1/2006	Chen		D603,472 S	11/2009	Chen
D514,183 S	1/2006	Schweigert		D604,783 S	11/2009	Solheim
D514,185 S	1/2006	Barez et al.		7,611,424 B2	11/2009	Nagai
D515,642 S	2/2006	Antonious		7,621,823 B2	11/2009	Beach
D516,650 S	3/2006	Stone		D605,715 S	12/2009	Toulon
D518,863 S	4/2006	Nishitani		D606,605 S	12/2009	Ban
D520,585 S	5/2006	Hasebe		D607,070 S	12/2009	Ban
D520,586 S	5/2006	Bingman		D607,071 S	12/2009	Ban
D522,077 S	5/2006	Jertson		7,632,194 B2	12/2009	Beach
D522,601 S	6/2006	Schweigert et al.		7,658,686 B2	2/2010	Soracco
D523,104 S	6/2006	Hasebe		D612,438 S	3/2010	Carlyle
D523,498 S	6/2006	Chen et al.		D612,439 S	3/2010	Carlyle
D523,501 S	6/2006	Schweigert		7,713,142 B2	5/2010	Hoffman
D523,917 S	6/2006	Roberts		7,717,804 B2	5/2010	Beach

# US D897,462 S

7,717,805 B2	5/2010	Beach	D729,892 S *	5/2015	Nicolette	D21/752
D617,406 S	6/2010	Carlyle	D733,234 S *	6/2015	Nicolette	D21/752
D618,293 S	6/2010	Foster et al.	9,199,140 B1 *	12/2015	Schweigert	A63B 53/0466
D618,746 S	6/2010	Jertson	9,199,143 B1	12/2015	Parsons	
D618,747 S	6/2010	Chen	D746,927 S *	1/2016	Parsons	D21/752
D618,753 S	6/2010	Jertson	D748,214 S	1/2016	Nicolette et al.	
D618,754 S	6/2010	Schweigert et al.	D748,749 S	2/2016	Nicolette et al.	
7,744,484 B1	6/2010	Chao	D753,251 S *	4/2016	Schweigert	D21/759
D621,893 S	8/2010	Nicolette	D755,319 S *	5/2016	Nicolette	D21/759
7,798,203 B2	9/2010	Schweigert	D756,471 S	5/2016	Schweigert	
7,798,917 B2	9/2010	Nguyen	9,352,197 B2 *	5/2016	Parsons	A63B 53/0466
7,815,521 B2	10/2010	Ban	D759,178 S *	6/2016	Nicolette	D21/759
7,846,040 B2	12/2010	Ban	D760,334 S *	6/2016	Schweigert	D21/752
7,846,041 B2	12/2010	Beach	9,427,634 B2	6/2016	Parsons	
D633,967 S	3/2011	Carlyle	9,399,158 B2 *	7/2016	Parsons	A63B 53/047
D635,626 S	4/2011	Nicolette	9,421,437 B2	8/2016	Parsons	
7,927,229 B2	4/2011	Jertson	D767,696 S *	9/2016	Parsons	D21/752
D638,893 S	5/2011	Schweigert et al.	D776,216 S *	1/2017	Schweigert	D21/752
D638,896 S	5/2011	Schweigert et al.	D777,858 S *	1/2017	Schweigert	D21/752
7,938,738 B2	5/2011	Roach	9,550,096 B2 *	1/2017	Parsons	A63B 53/0466
7,963,861 B2	6/2011	Beach	9,555,295 B2 *	1/2017	Schweigert	A63B 53/0466
D643,490 S	8/2011	Ban	9,630,070 B2 *	4/2017	Parsons	A63B 53/0466
8,012,038 B1	9/2011	Beach	D786,377 S *	5/2017	Parsons	D21/752
D647,585 S	10/2011	Jertson et al.	D795,978 S *	8/2017	Parsons	D21/759
8,062,150 B2	11/2011	Gilbert	9,782,643 B2 *	10/2017	Parsons	A63B 53/0466
8,088,025 B2	1/2012	Wahl	D802,069 S *	11/2017	Parsons	D21/752
8,092,319 B1	1/2012	Cackett	D802,070 S *	11/2017	Parsons	D21/752
8,105,180 B1	1/2012	Cackett	9,833,667 B1 *	12/2017	Parsons	A63B 53/0466
D658,248 S	4/2012	Toulon	D807,976 S *	1/2018	Parsons	D21/752
D661,751 S	6/2012	Jertson	9,861,867 B2 *	1/2018	Parsons	A63B 53/0466
D661,756 S	6/2012	Jertson	9,895,583 B2 *	2/2018	Parsons	A63B 53/04
8,221,262 B1	7/2012	Cackett	9,981,160 B2 *	5/2018	Parsons	A63B 53/0475
8,246,487 B1	8/2012	Cackett	D822,134 S *	7/2018	Parsons	D21/752
8,257,196 B1	9/2012	Abbott	D827,067 S	8/2018	Becktor	
8,257,197 B2	9/2012	Schweigert	D827,745 S *	9/2018	Schweigert	D21/752
8,262,506 B2	9/2012	Watson	D839,372 S *	1/2019	Schweigert	D21/752
8,328,662 B2	12/2012	Nakamura	10,293,221 B2 *	5/2019	Parsons	A63B 53/0466
D673,630 S	1/2013	Schweigert	D850,551 S *	6/2019	Parsons	D21/759
D673,632 S	1/2013	Chen	D852,303 S *	6/2019	Parsons	D21/752
8,371,957 B2	2/2013	Schweigert	D852,304 S *	6/2019	Parsons	D21/752
8,376,878 B2	2/2013	Bennett	D852,305 S *	6/2019	Parsons	D21/752
D680,179 S	4/2013	Chen	D865,886 S *	11/2019	Parsons	D21/752
D681,142 S	4/2013	Fossum et al.	2002/0107087 A1	8/2002	Fagot	
8,414,422 B2	4/2013	Peralta	2003/0139226 A1	7/2003	Cheng	
8,485,919 B2	7/2013	Rice	2003/0176231 A1	9/2003	Hasebe	
8,506,420 B2	8/2013	Hocknell	2004/0204263 A1	10/2004	Fagot	
D689,156 S	9/2013	Schweigert	2005/0009632 A1	1/2005	Schweigert	
D691,230 S	10/2013	Jertson	2005/0014573 A1	1/2005	Lee	
8,545,343 B2	10/2013	Boyd	2005/0119066 A1	6/2005	Stites	
8,562,457 B2	10/2013	Beach	2005/0239569 A1	10/2005	Best	
8,574,094 B2	11/2013	Nicolette	2005/0277485 A1	12/2005	Hou	
8,608,587 B2	12/2013	Henrikson	2006/0105856 A1	5/2006	Lo	
8,628,431 B2	1/2014	Schweigert	2006/0111200 A1	5/2006	Poynor	
8,657,700 B2	2/2014	Nicolette	2007/0032308 A1	2/2007	Fagot	
8,663,026 B2	3/2014	Blowers	2007/0225084 A1	9/2007	Schweigert	
8,690,710 B2	4/2014	Nicolette	2007/0293344 A1	12/2007	Davis	
D707,316 S	6/2014	Brunski	2008/0004133 A1	1/2008	Schweigert	
D707,317 S	6/2014	Brunski	2008/0058113 A1	3/2008	Nicolette	
8,753,230 B2	6/2014	Stokke	2008/0188322 A1	8/2008	Anderson	
8,777,778 B2	7/2014	Solheim	2008/0300065 A1	12/2008	Schweigert	
8,784,232 B2	7/2014	Jertson	2009/0029790 A1	1/2009	Nicolette	
8,790,196 B2	7/2014	Solheim	2009/0029795 A1	1/2009	Schweigert	
8,808,108 B2	8/2014	Schweigert	2010/0130306 A1	5/2010	Schweigert	
D712,989 S	9/2014	Gillig	2010/0144461 A1 *	6/2010	Ban	A63B 53/0466
8,626,512 B2	9/2014	Schweigert				473/338
8,827,832 B2	9/2014	Breier	2010/0178999 A1	7/2010	Nicolette	
8,827,833 B2	9/2014	Amano	2011/0111883 A1	5/2011	Cackett	
8,845,455 B2	9/2014	Ban	2011/0143858 A1	6/2011	Peralta	
D714,894 S	10/2014	Tang	2011/0165963 A1	7/2011	Cackett	
D716,387 S	10/2014	Brunski	2011/0269567 A1	11/2011	Ban	
D716,388 S	10/2014	Brunski	2011/0294596 A1	12/2011	Ban	
8,858,362 B1	10/2014	Leposky	2012/0202615 A1 *	8/2012	Beach	A63B 53/0466
D721,544 S	1/2015	Hollander				473/338
D722,352 S	2/2015	Nicolette et al.	2013/0137532 A1	5/2013	Deshmukh	
D723,120 S	2/2015	Nicolette	2013/0225319 A1	8/2013	Kato	
8,961,336 B1	2/2015	Parsons	2013/0281226 A1	10/2013	Ban	
D724,164 S *	3/2015	Schweigert	2013/0288823 A1	10/2013	Hebreo	D21/752
8,979,671 B1	3/2015	Demille	2013/0303303 A1	11/2013	Ban	
D726,265 S	4/2015	Nicolette	2013/0303304 A1	11/2013	Sato	

2013/0310192	A1	11/2013	Wahl
2014/0080621	A1	3/2014	Nicolette
2014/0128175	A1	5/2014	Jertson
2014/0274441	A1	9/2014	Greer
2014/0274451	A1	9/2014	Knight
2015/0231454	A1	8/2015	Parsons
2015/0231806	A1	8/2015	Parsons

OTHER PUBLICATIONS

International Search Report and Written Opinion Received in Connection With the Corresponding Application No. PCT/US2015/016666, dated May 14, 2015 (8 Pages).

International Search Report and Written Opinion Received in Connection With the Corresponding Application No. PCT/US15/42484, dated Oct. 19, 2015 (12 Pages).

International Search Report and Written Opinion Received in Connection With the Corresponding Application No. PCTUS2015042282, dated Oct. 13, 2015 (12 Pages).

Kozuchowski, Zak, "Callaway Mack Daddy 2 PM Grind Wedges" (<http://golfwrz.com/276203/callaway-mack-daddy-2-pm-grind-wedges/>), www.golfwrz.com, Golfwrz Holdings, LLC, Published Jan. 21, 2015.

Wall, Jonathan, "Details: Phil's Prototype Mack Daddy PM-Grind Wedge," (<http://www.pgatour.com/equipmentreport/2015/01/21/callaway-wedge.html>), www.pgatour.com, PGA Tour, Inc., Published Jan. 21, 2015.

U.S. Appl. No. 29/512,313, Nicolette, "Golf Club Head," filed Dec. 18, 2018.

\* cited by examiner

Primary Examiner — Mitchell I. Siegel

(57) CLAIM

The ornamental design for a golf club head, as shown and described.

DESCRIPTION

FIG. 1 is a top perspective view of a golf club head;  
 FIG. 2 is a bottom perspective view of the golf club head of FIG. 1;  
 FIG. 3 is a front elevational view of the golf club head of FIG. 1;  
 FIG. 4 is a rear elevational view of the golf club head of FIG. 1;  
 FIG. 5 is a top view of the golf club head of FIG. 1;  
 FIG. 6 is a bottom view of the golf club head of FIG. 1;  
 FIG. 7 is a left side view of the golf club head of FIG. 1;  
 FIG. 8 is a right side view of the golf club head of FIG. 1;  
 FIG. 9 is a top perspective view of a golf club head;

FIG. 10 is a bottom perspective view of the golf club head of FIG. 9;  
 FIG. 11 is a front elevational view of the golf club head of FIG. 9;  
 FIG. 12 is a rear elevational view of the golf club head of FIG. 9;  
 FIG. 13 is a top view of the golf club head of FIG. 9;  
 FIG. 14 is a bottom view of the golf club head of FIG. 9;  
 FIG. 15 is a left side view of the golf club head of FIG. 9;  
 FIG. 16 is a right side view of the golf club head of FIG. 9;  
 FIG. 17 is a top perspective view of a golf club head;  
 FIG. 18 is a bottom perspective view of the golf club head of FIG. 17;  
 FIG. 19 is a front elevational view of the golf club head of FIG. 17;  
 FIG. 20 is a rear elevational view of the golf club head of FIG. 17;  
 FIG. 21 is a top view of the golf club head of FIG. 17;  
 FIG. 22 is a bottom view of the golf club head of FIG. 17;  
 FIG. 23 is a left side view of the golf club head of FIG. 17;  
 FIG. 24 is a right side view of the golf club head of FIG. 17;  
 FIG. 25 is a top perspective view of a golf club head;  
 FIG. 26 is a bottom perspective view of the golf club head of FIG. 25;  
 FIG. 27 is a front elevational view of the golf club head of FIG. 25;  
 FIG. 28 is a rear elevational view of the golf club head of FIG. 25;  
 FIG. 29 is a top view of the golf club head of FIG. 25;  
 FIG. 30 is a bottom view of the golf club head of FIG. 25;  
 FIG. 31 is a left side view of the golf club head of FIG. 25;  
 FIG. 32 is a right side view of the golf club head of FIG. 25;  
 FIG. 33 is a top perspective view of a golf club head;  
 FIG. 34 is a bottom perspective view of the golf club head of FIG. 33;  
 FIG. 35 is a front elevational view of the golf club head of FIG. 33;  
 FIG. 36 is a rear elevational view of the golf club head of FIG. 33;  
 FIG. 37 is a top view of the golf club head of FIG. 33;  
 FIG. 38 is a bottom view of the golf club head of FIG. 33;  
 FIG. 39 is a left side view of the golf club head of FIG. 33;  
 and,  
 FIG. 40 is a right side view of the golf club head of FIG. 33.  
 The broken line showing is included for the purpose of illustrating unclaimed subject matter and forms no part of the claimed design.

1 Claim, 35 Drawing Sheets

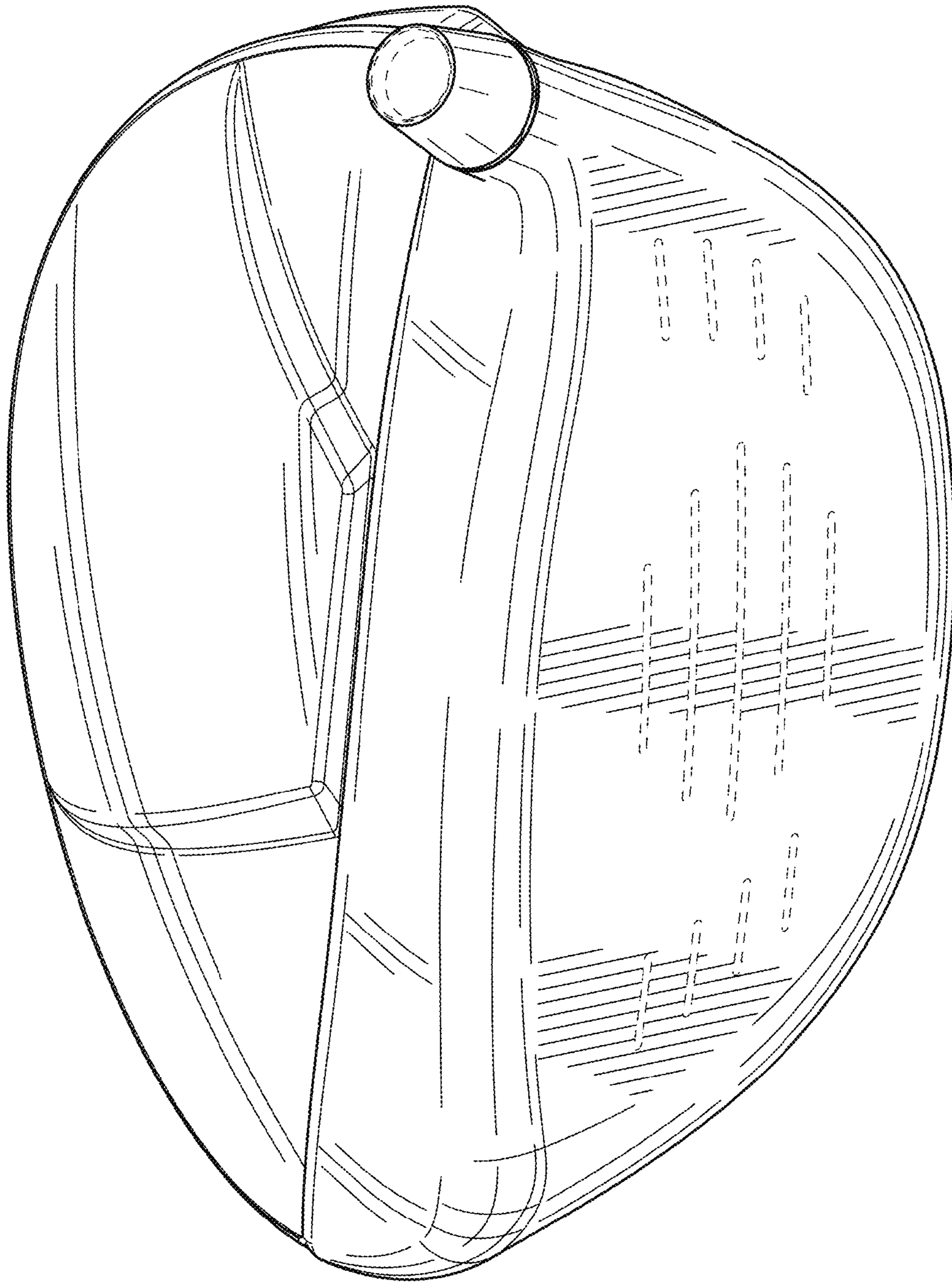

FIG. 1

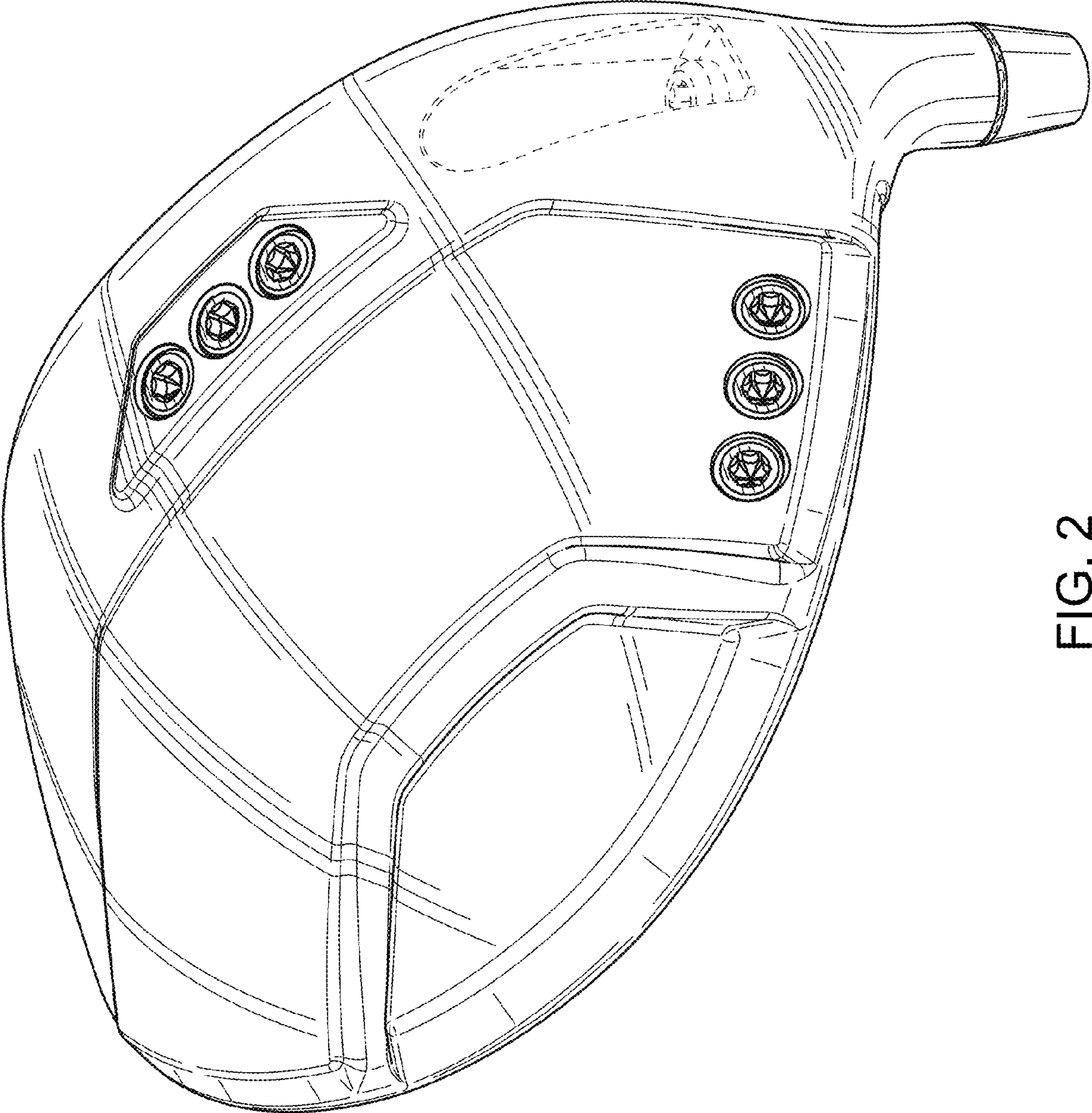

FIG. 2

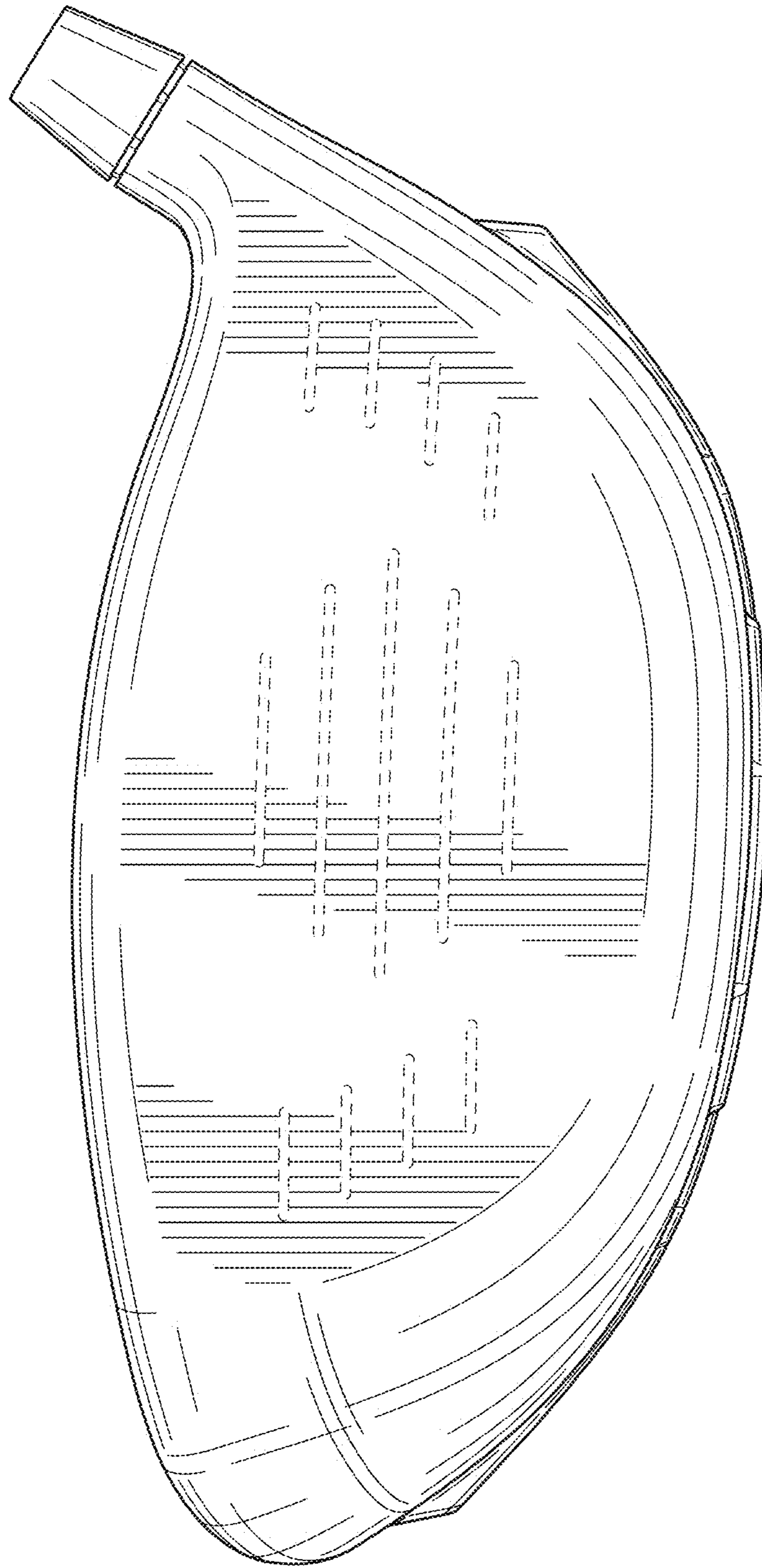

FIG. 3

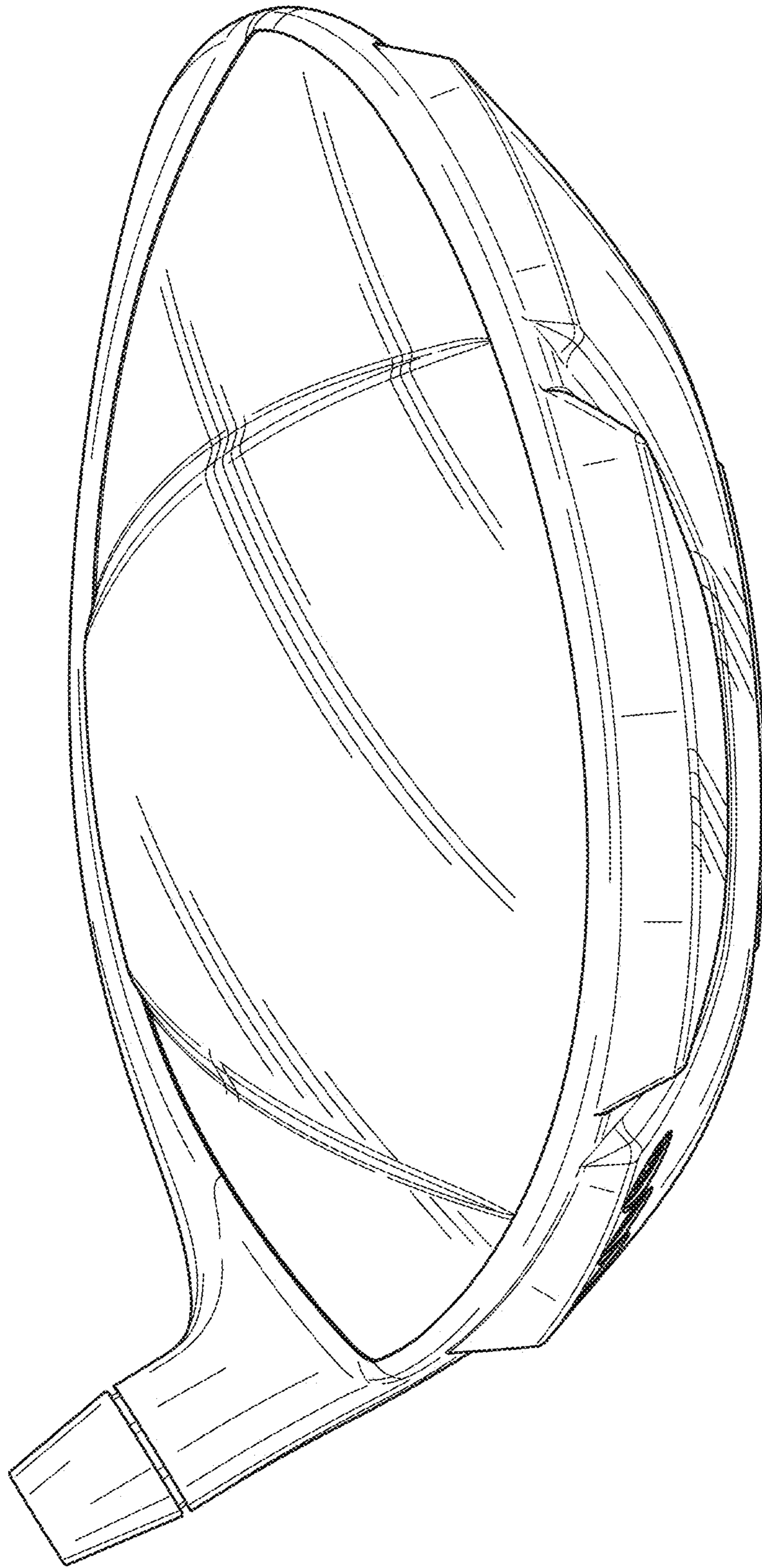

FIG. 4



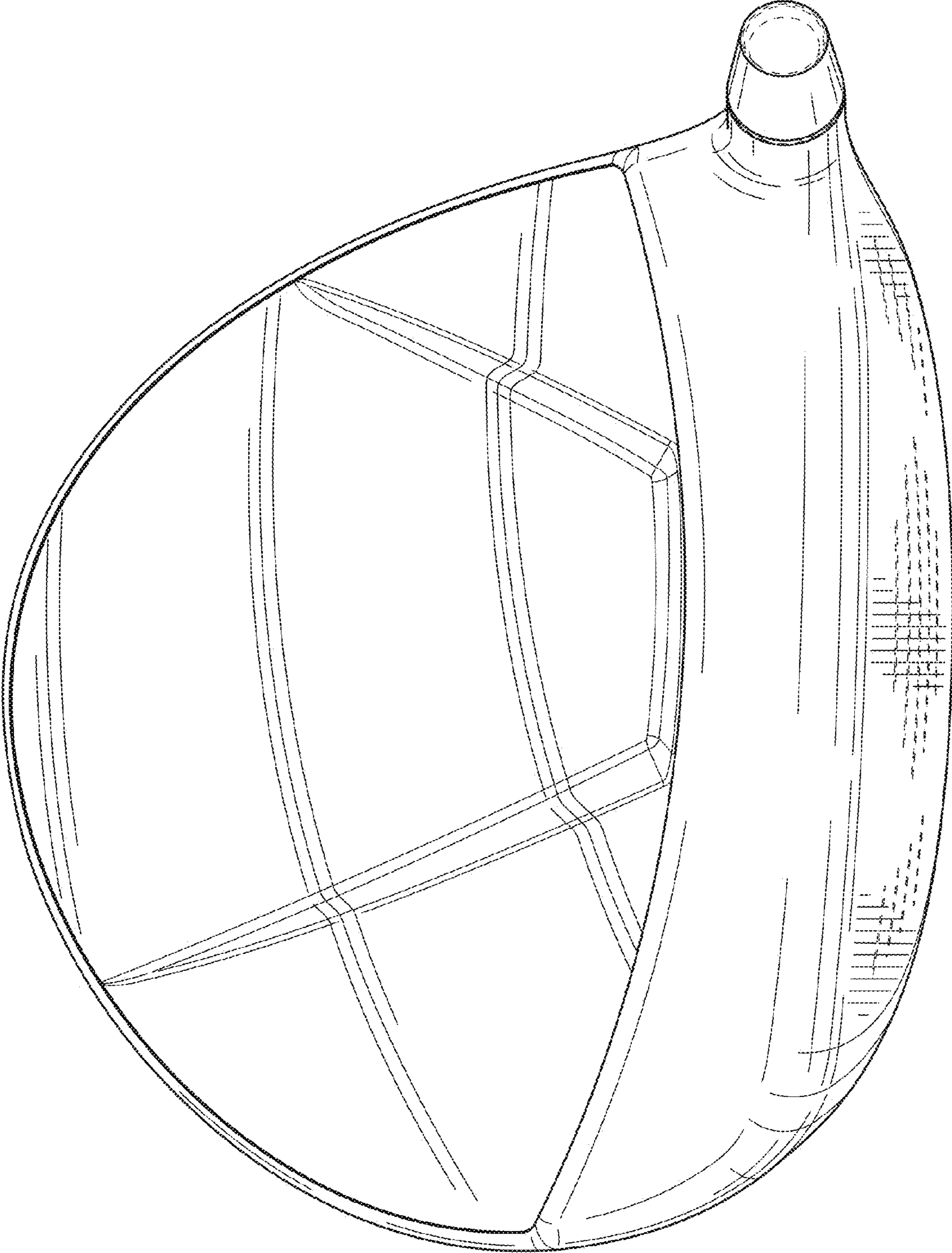

FIG. 5

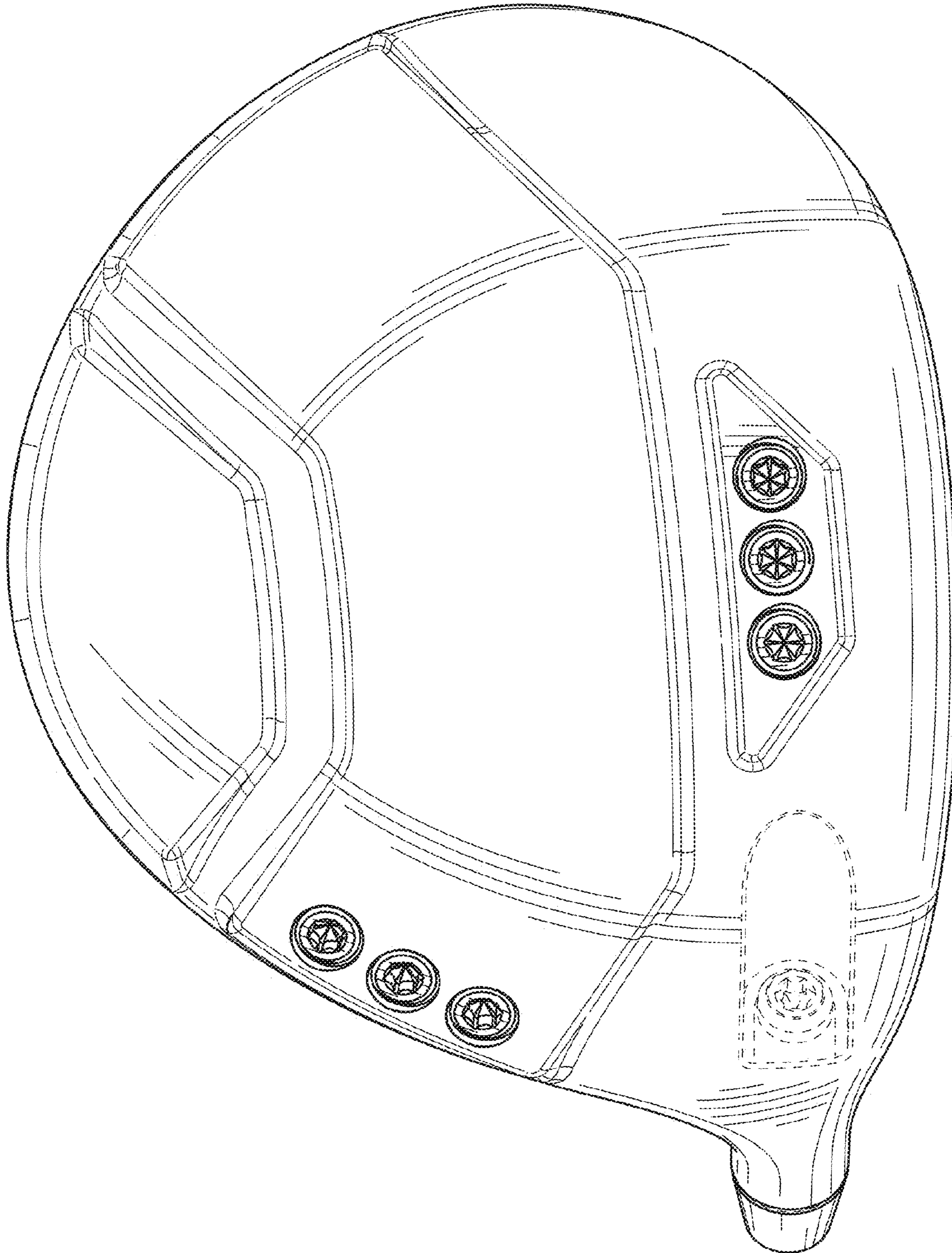

FIG. 6

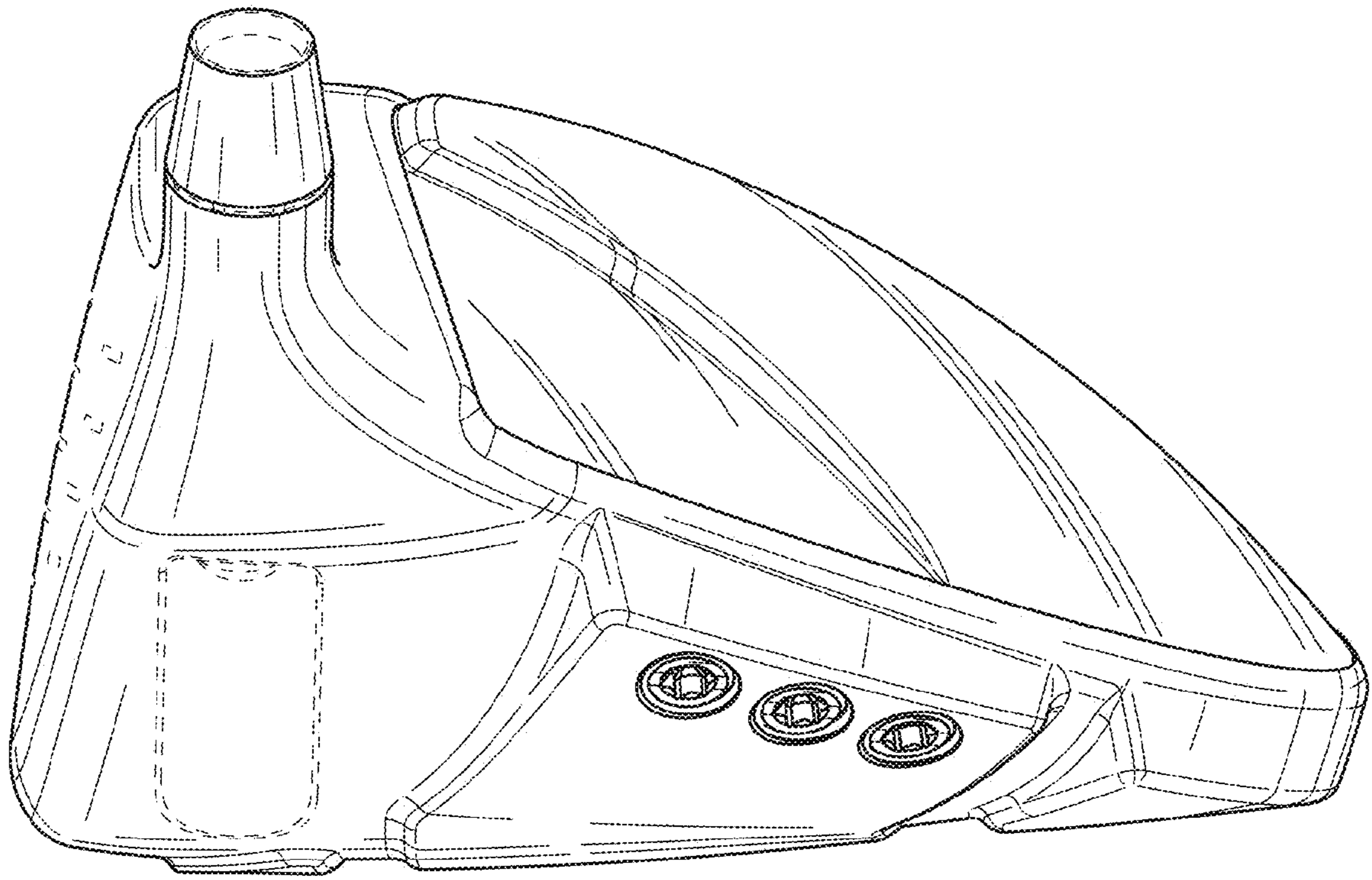

FIG. 7

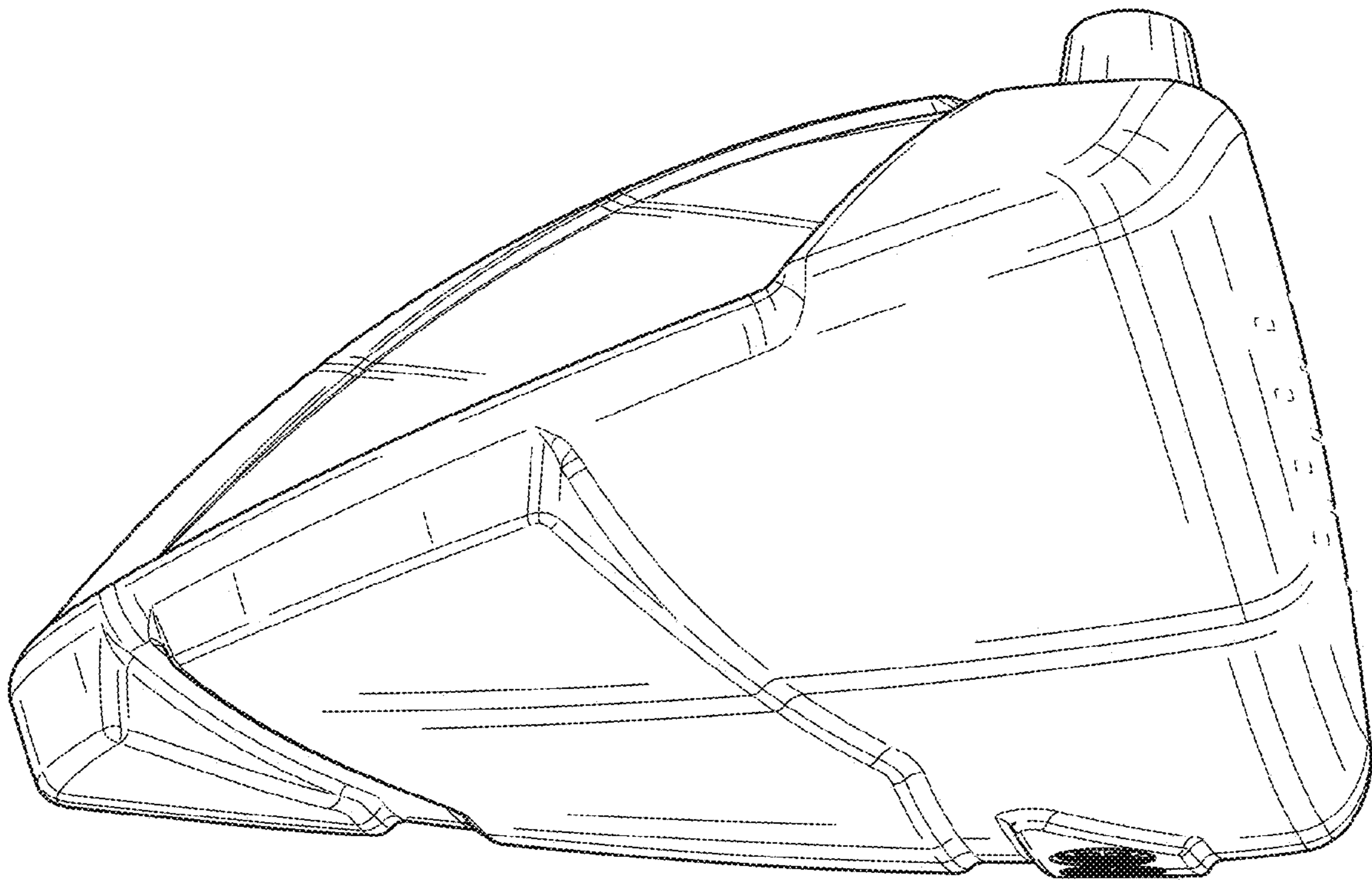

FIG. 8

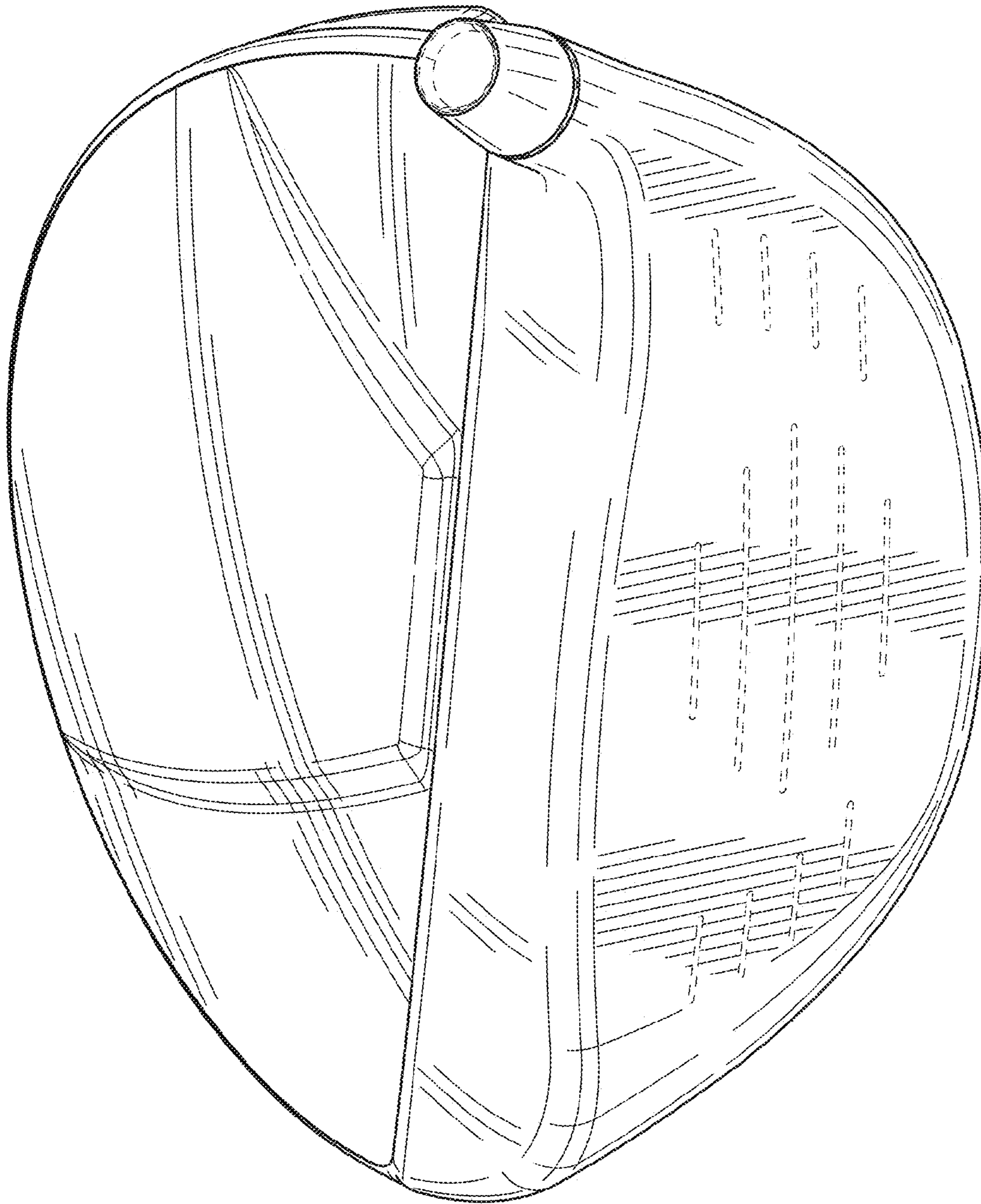

FIG. 9

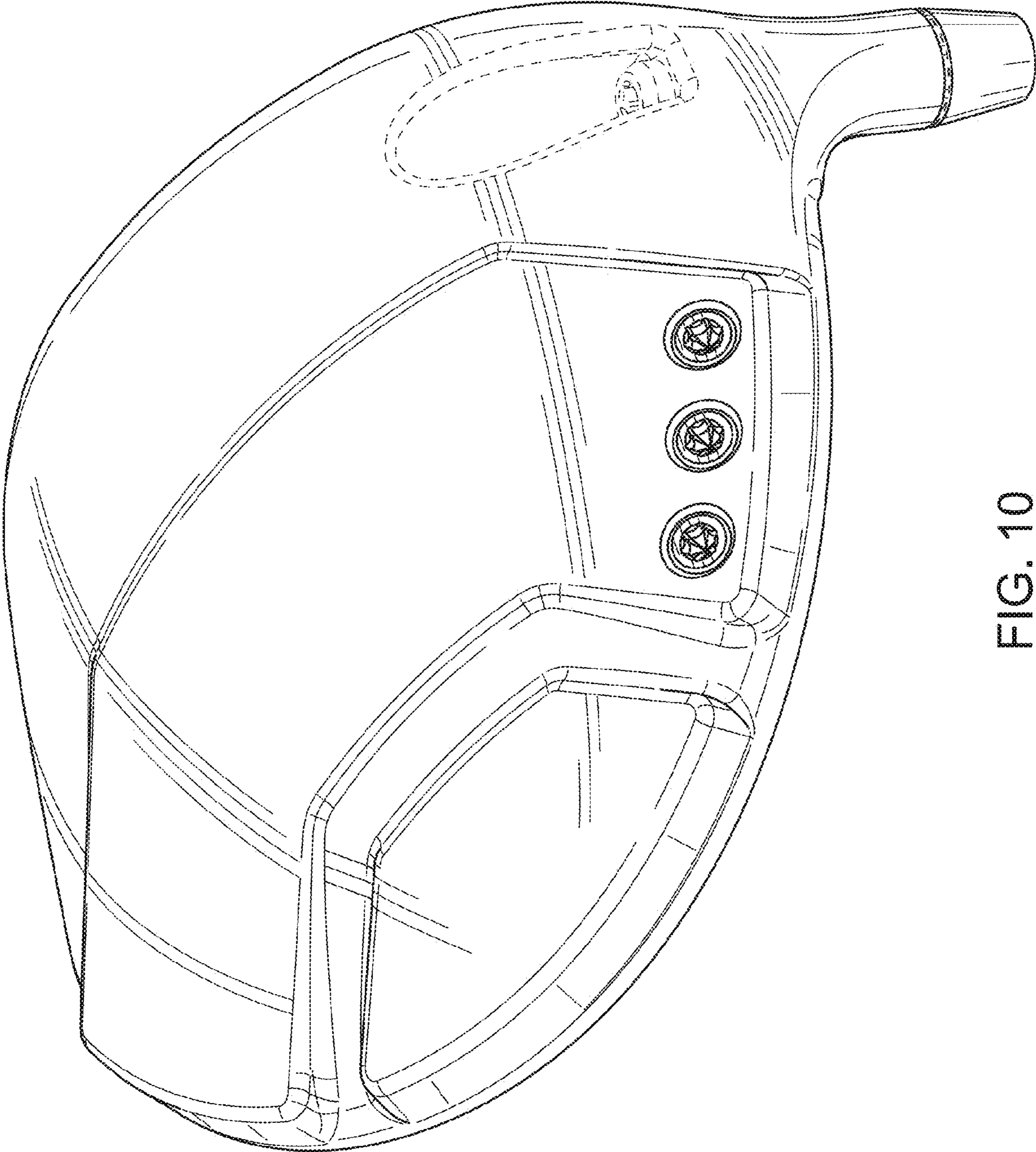

FIG. 10

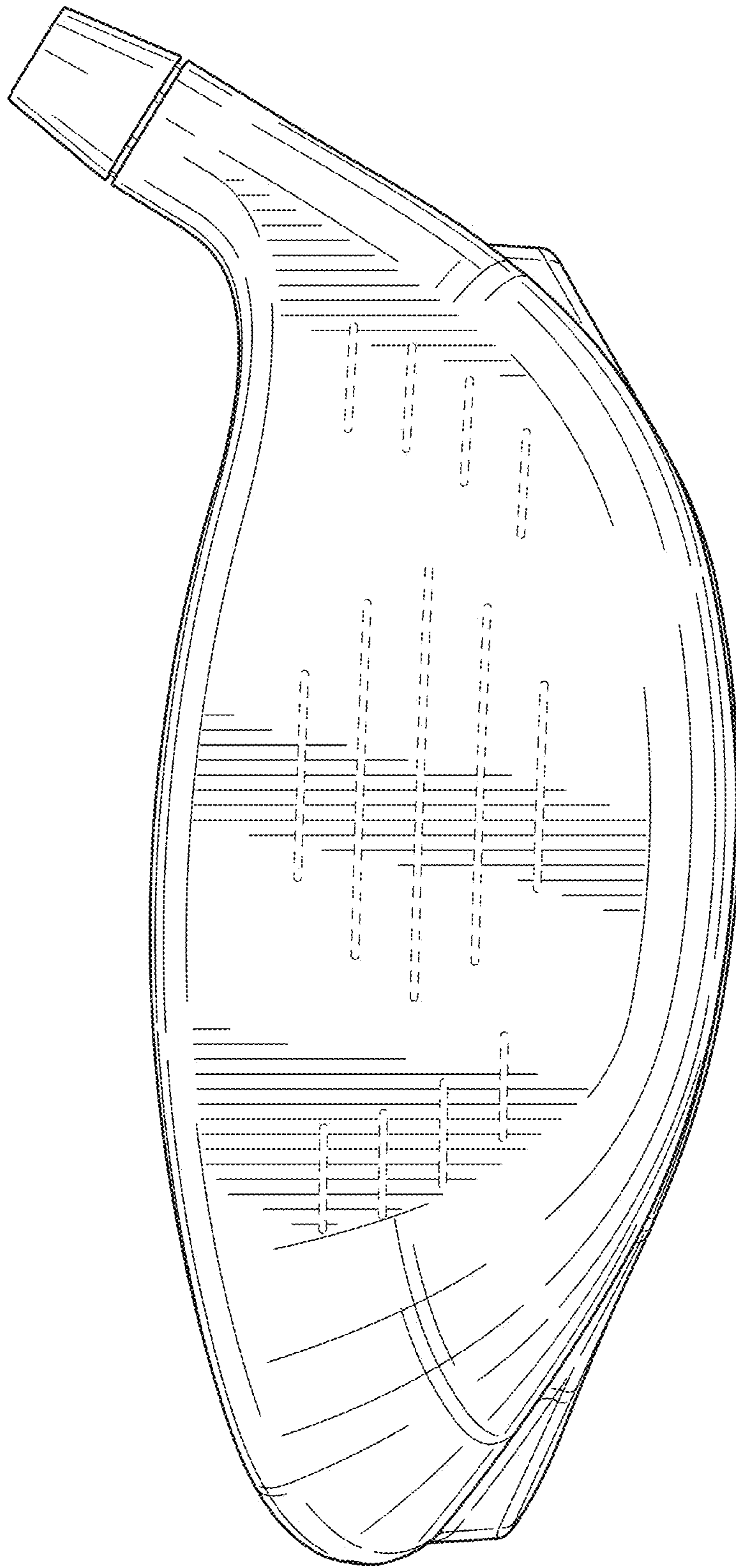

FIG. 11

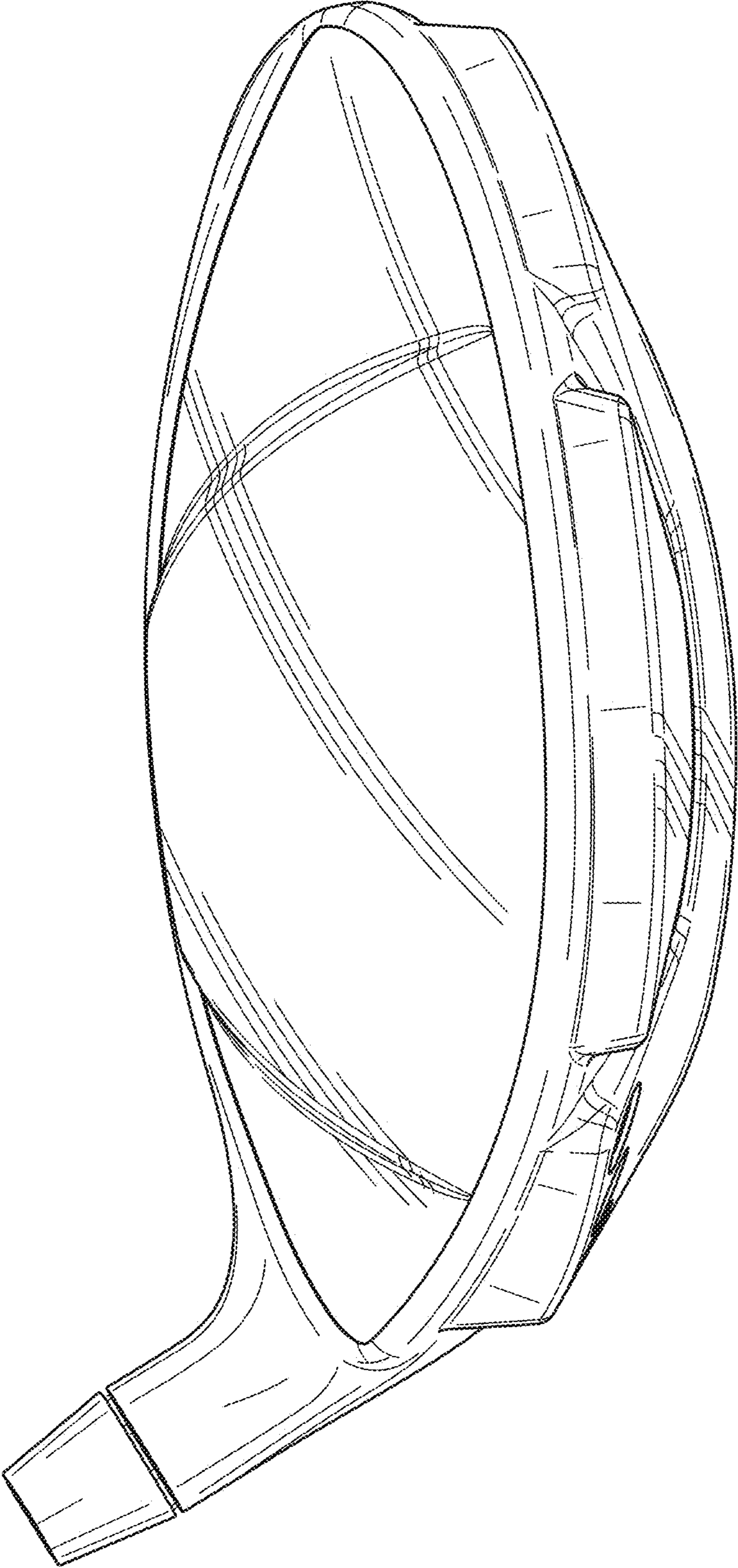

FIG. 12

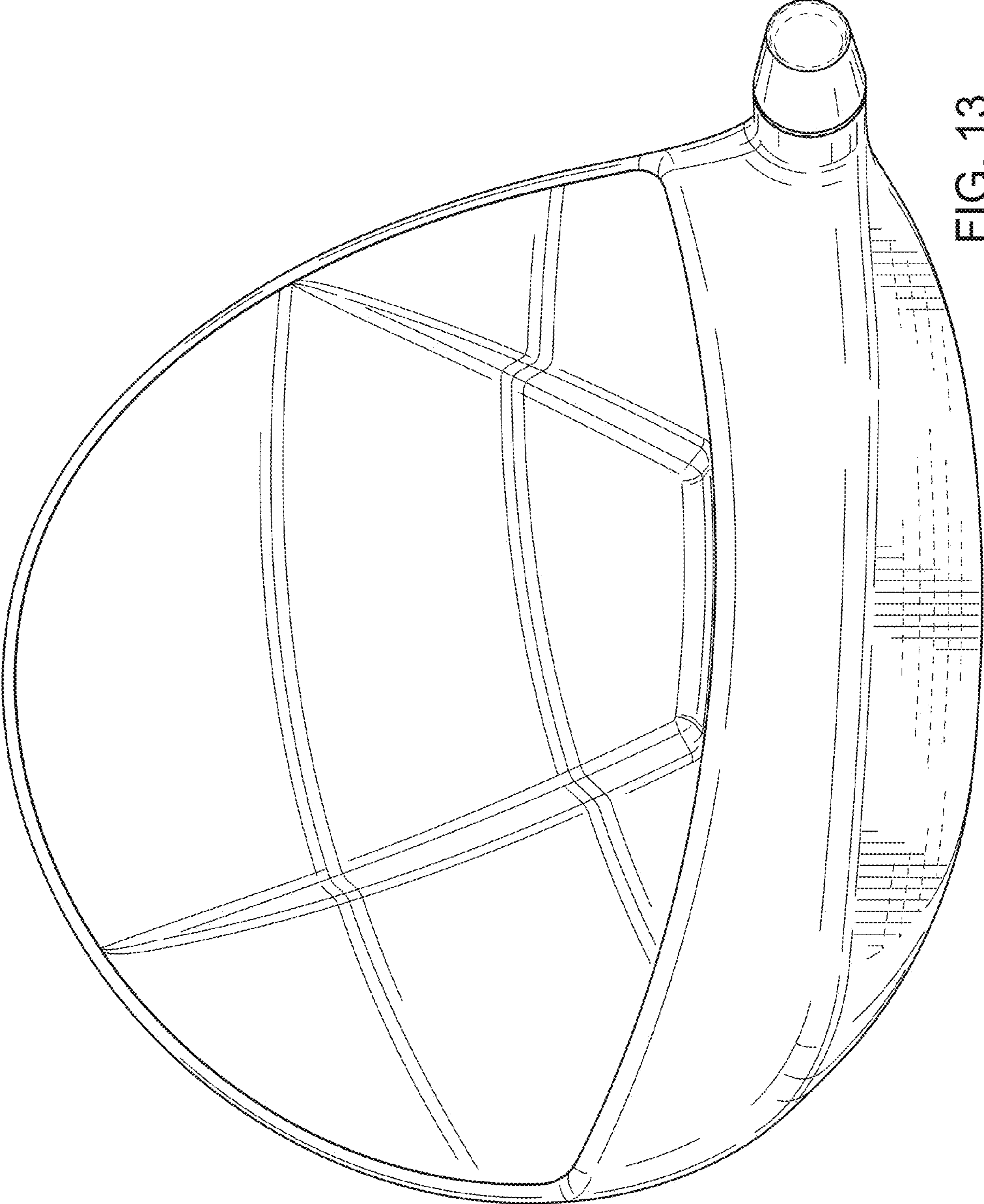

FIG. 13



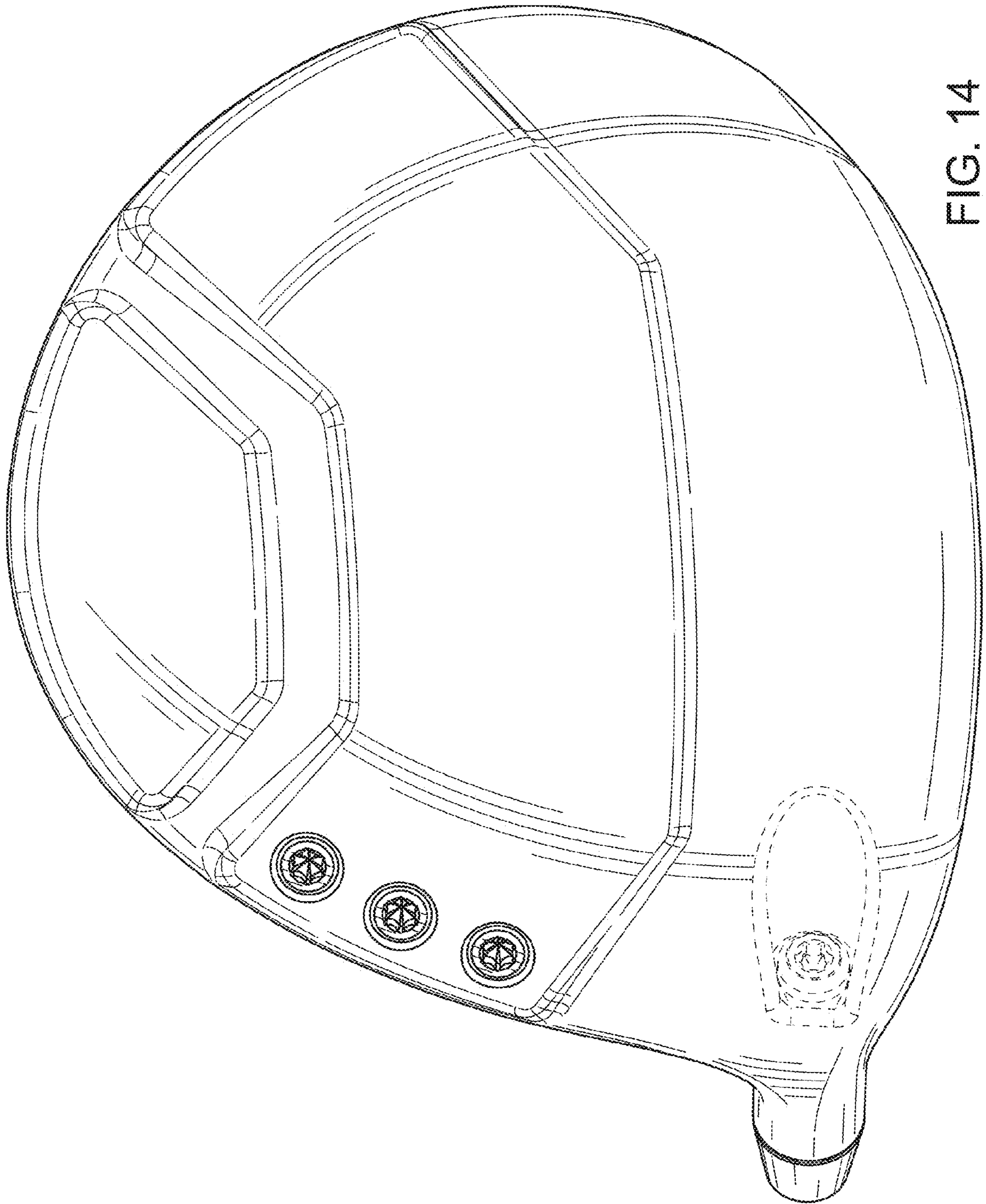

FIG. 14

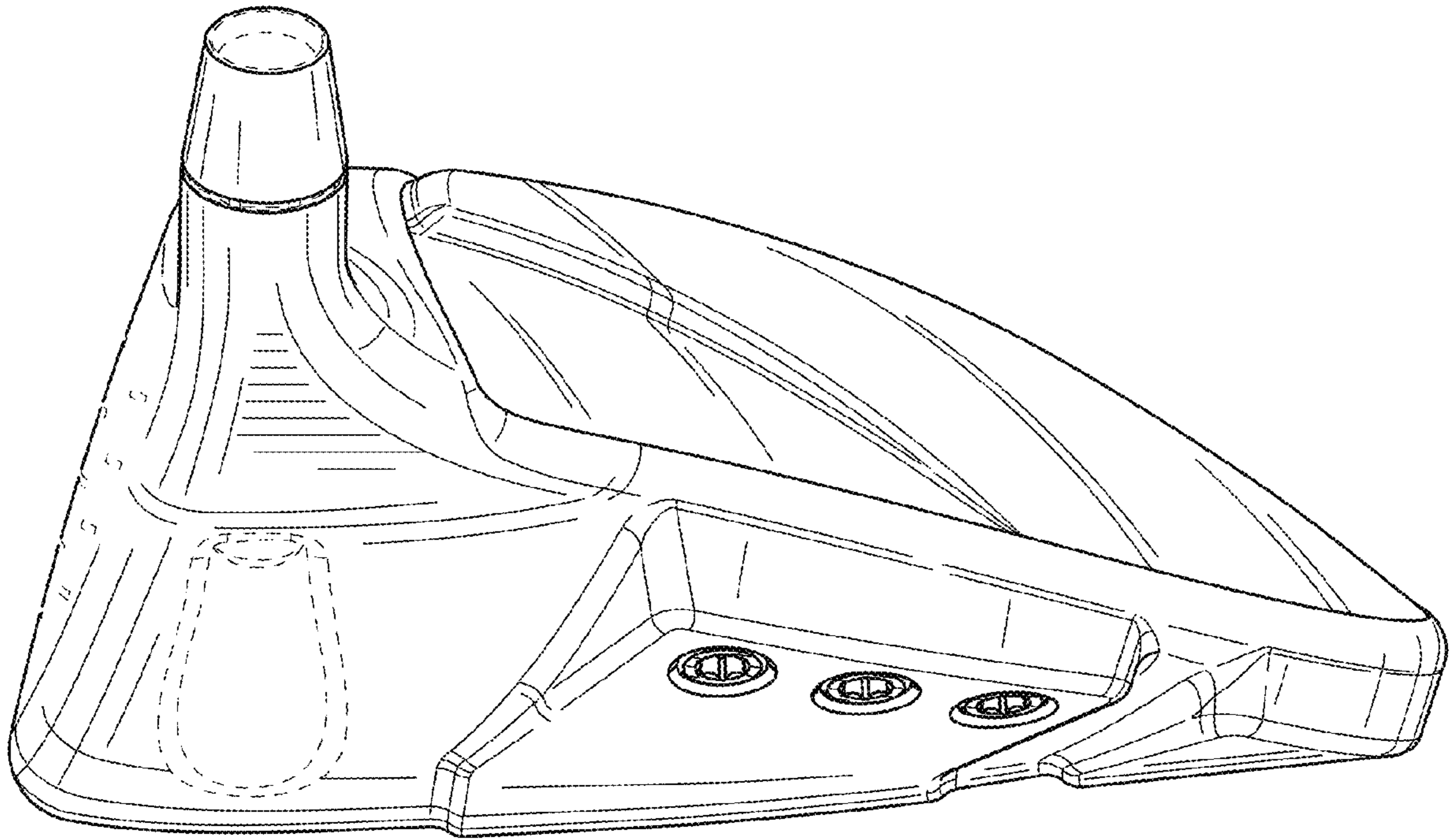

FIG. 15

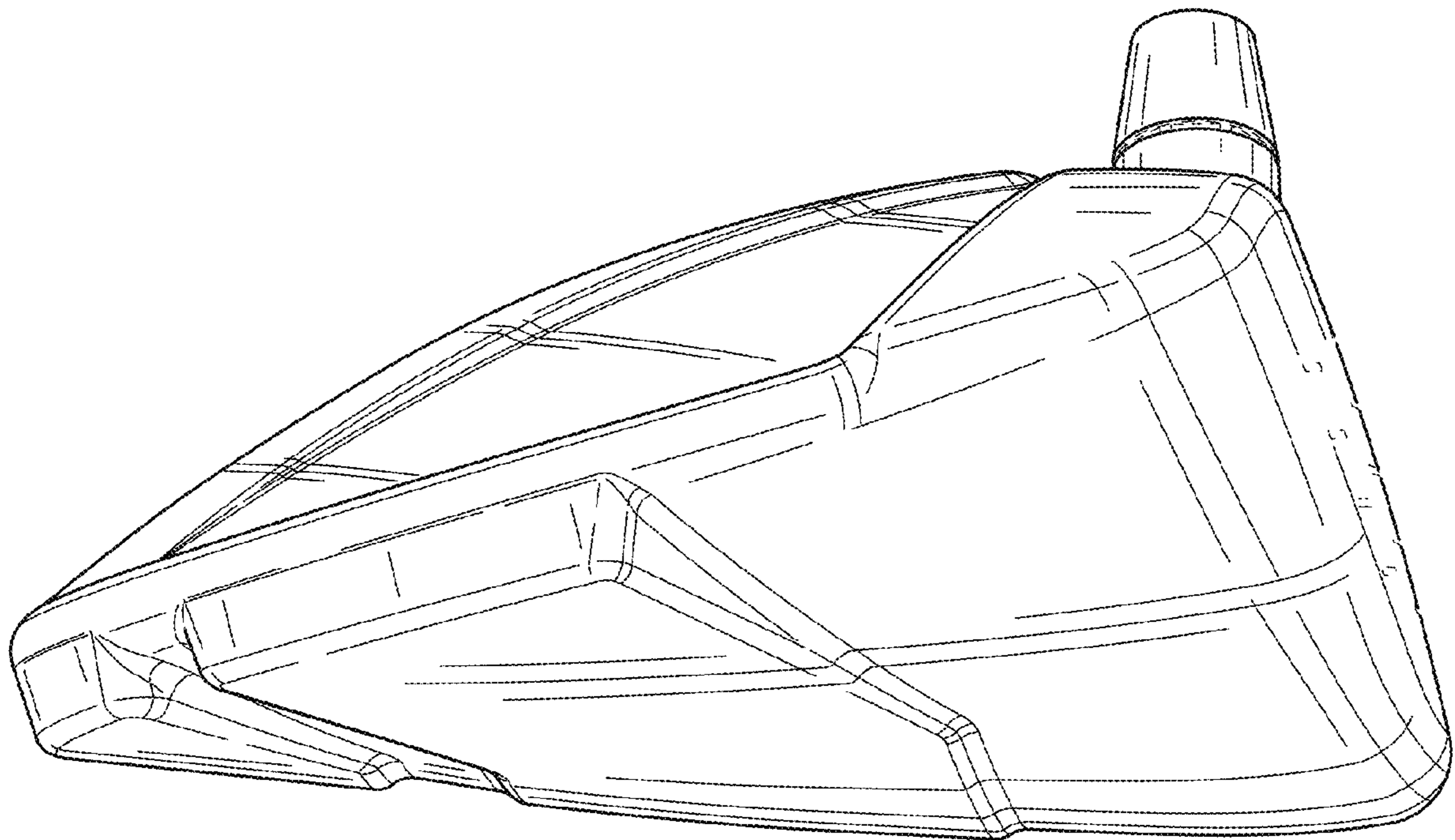

FIG. 16

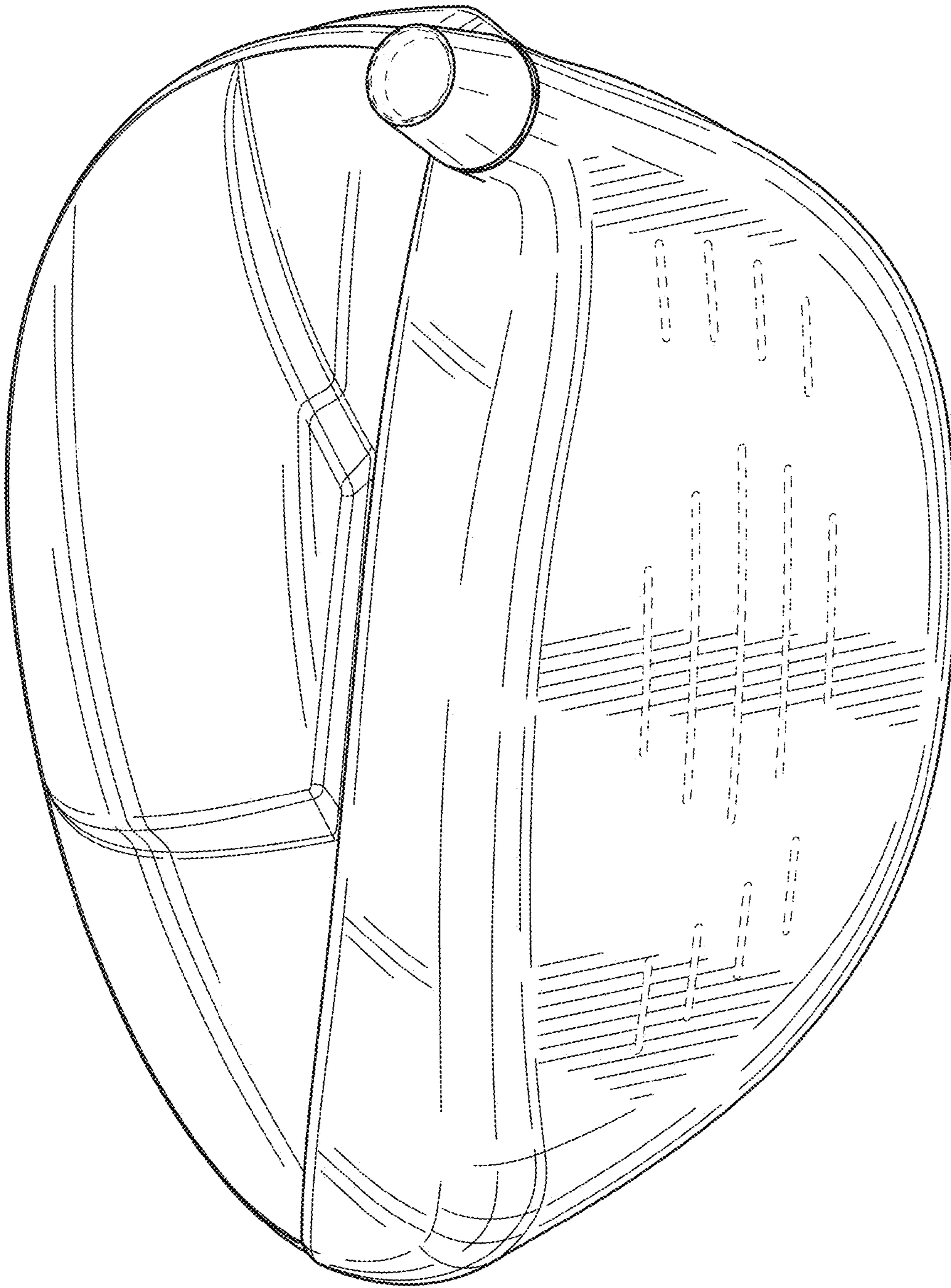

FIG. 17

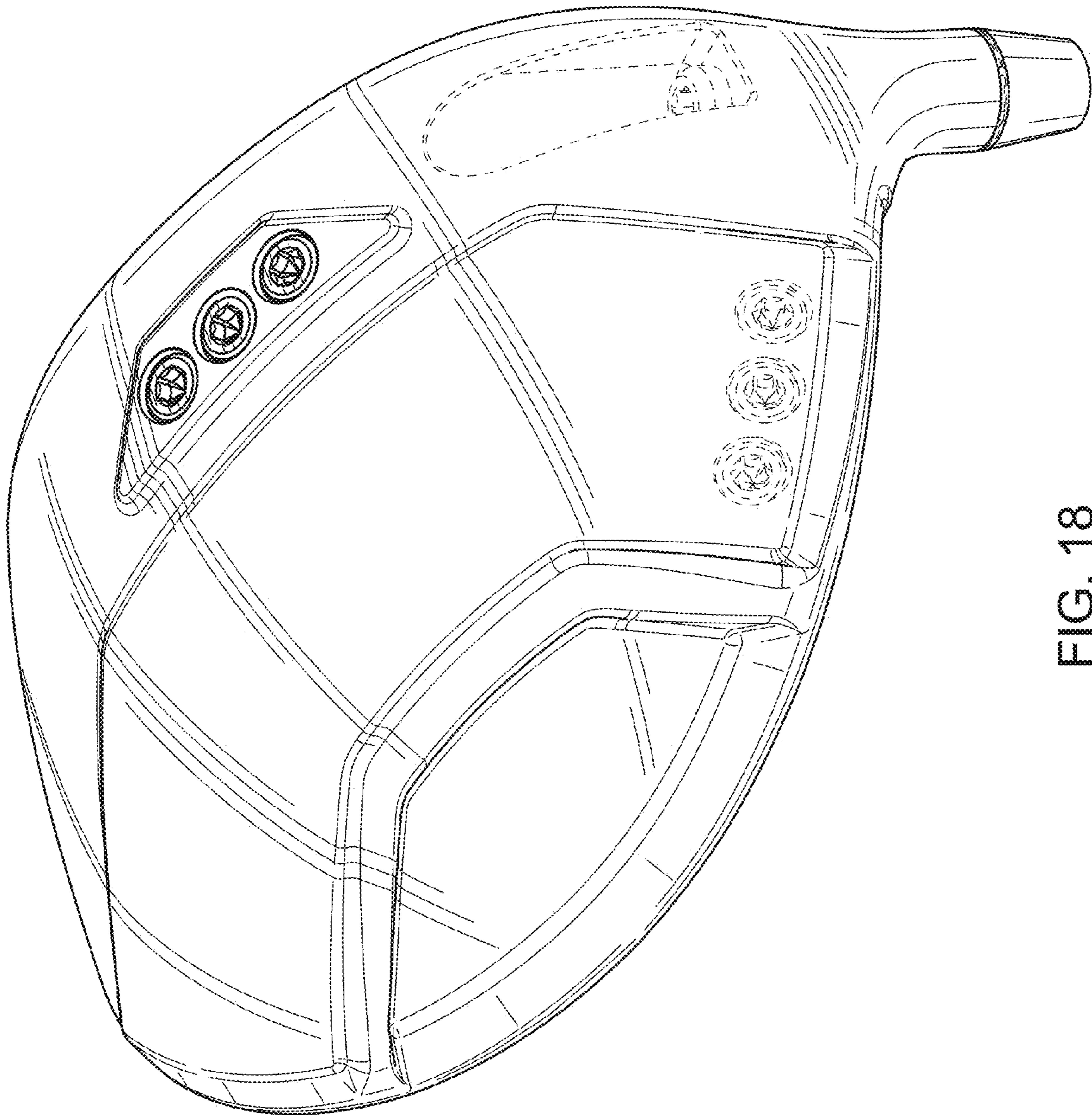

FIG. 18

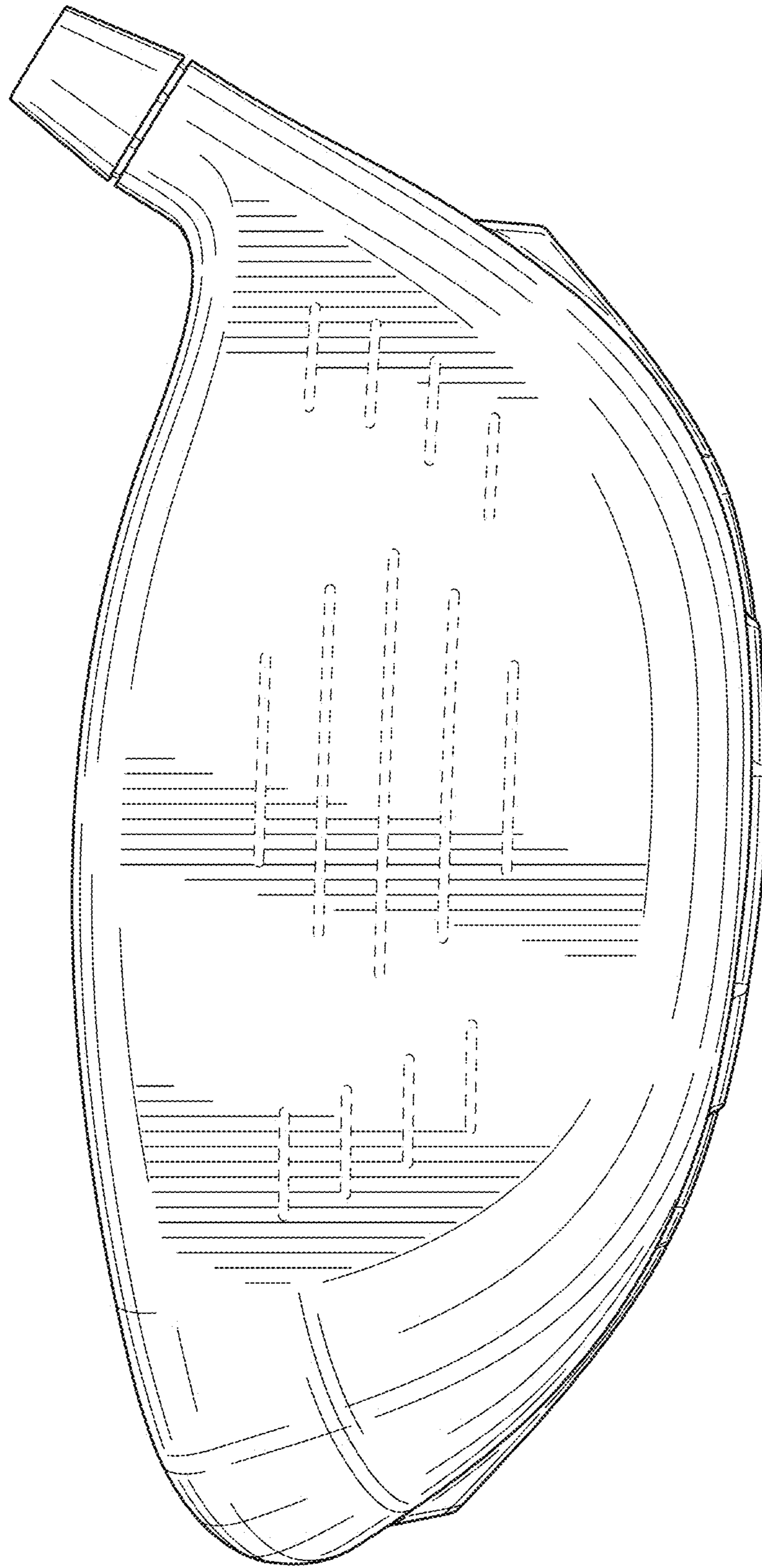

FIG. 19

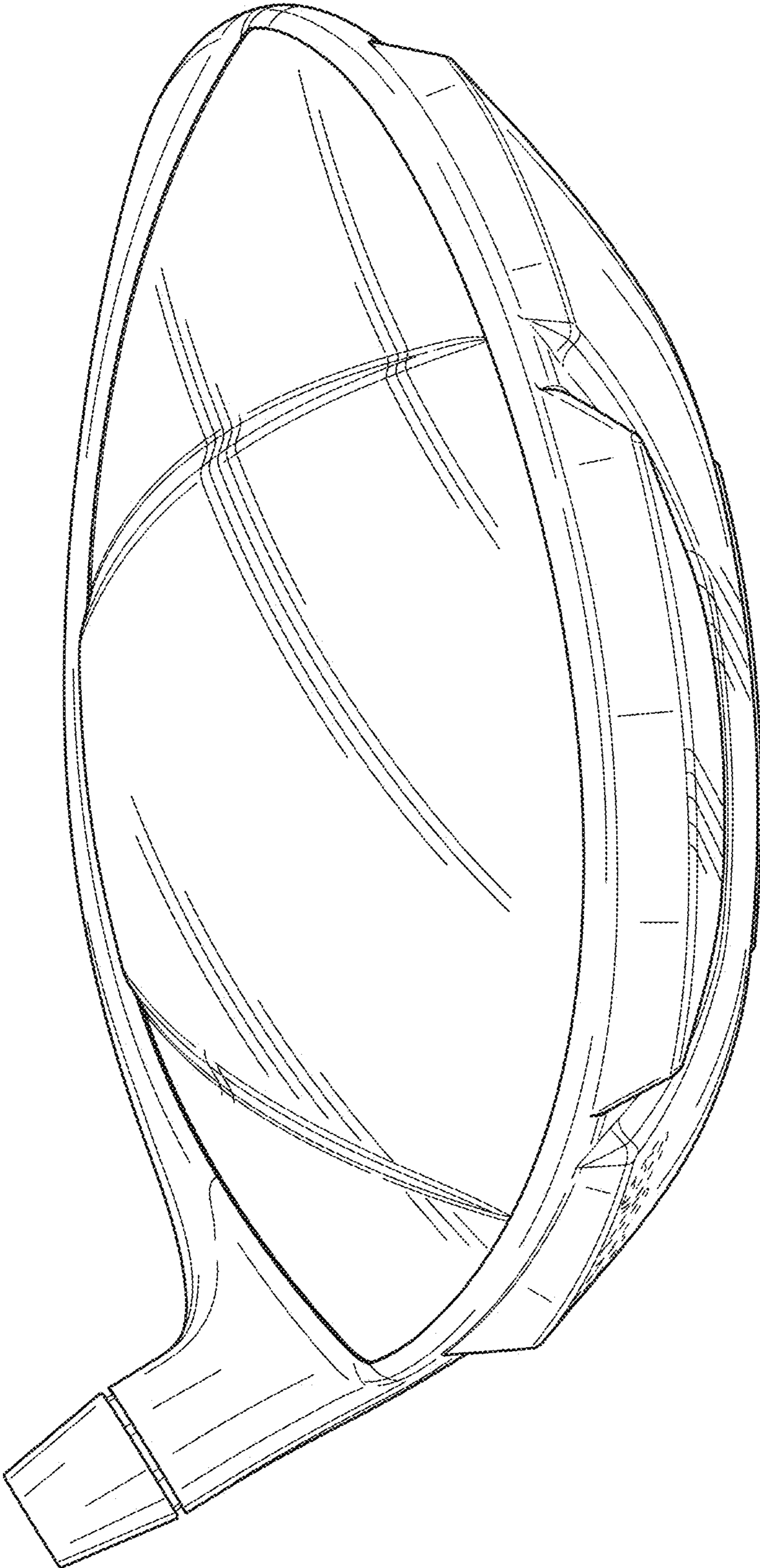

FIG. 20

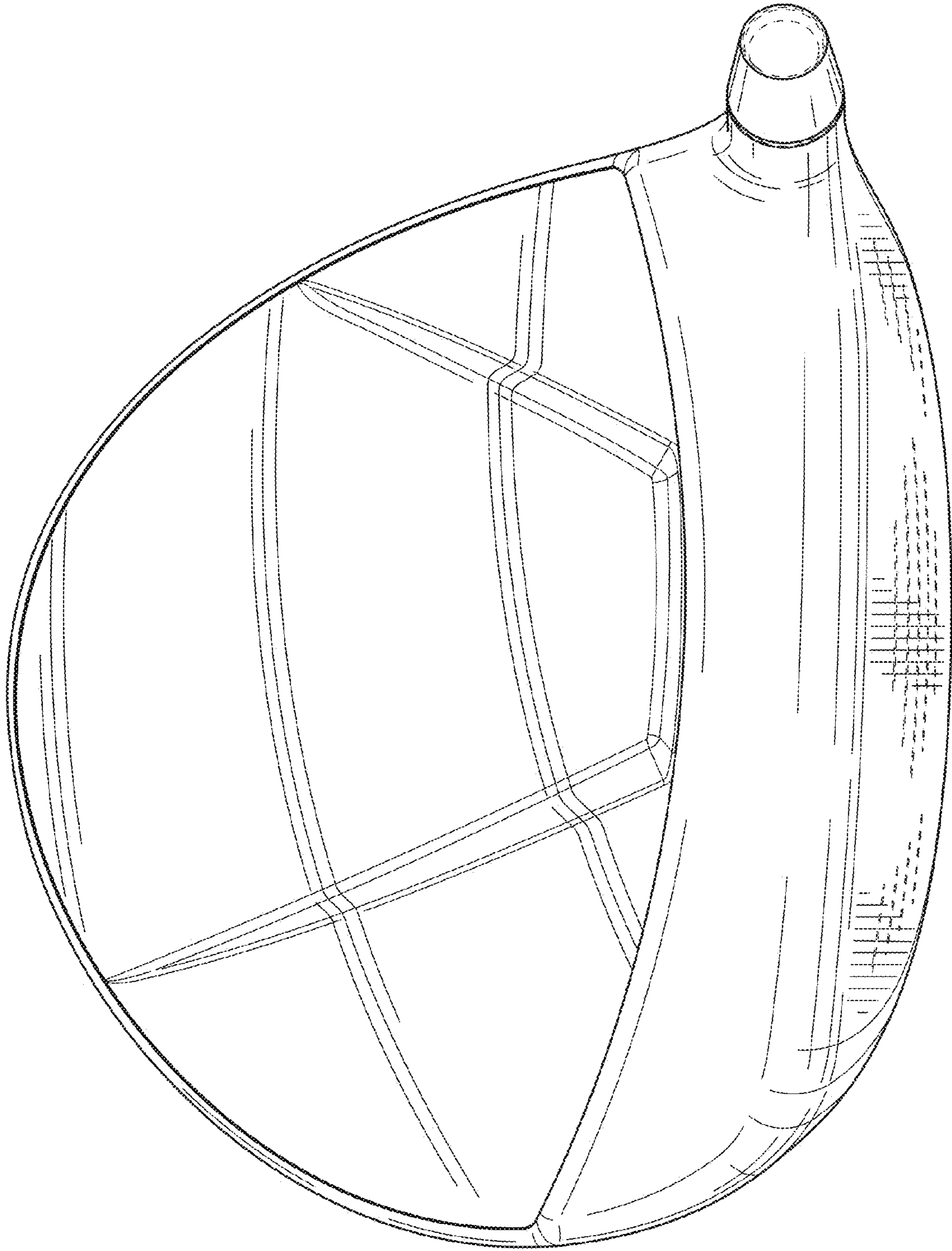

FIG. 21

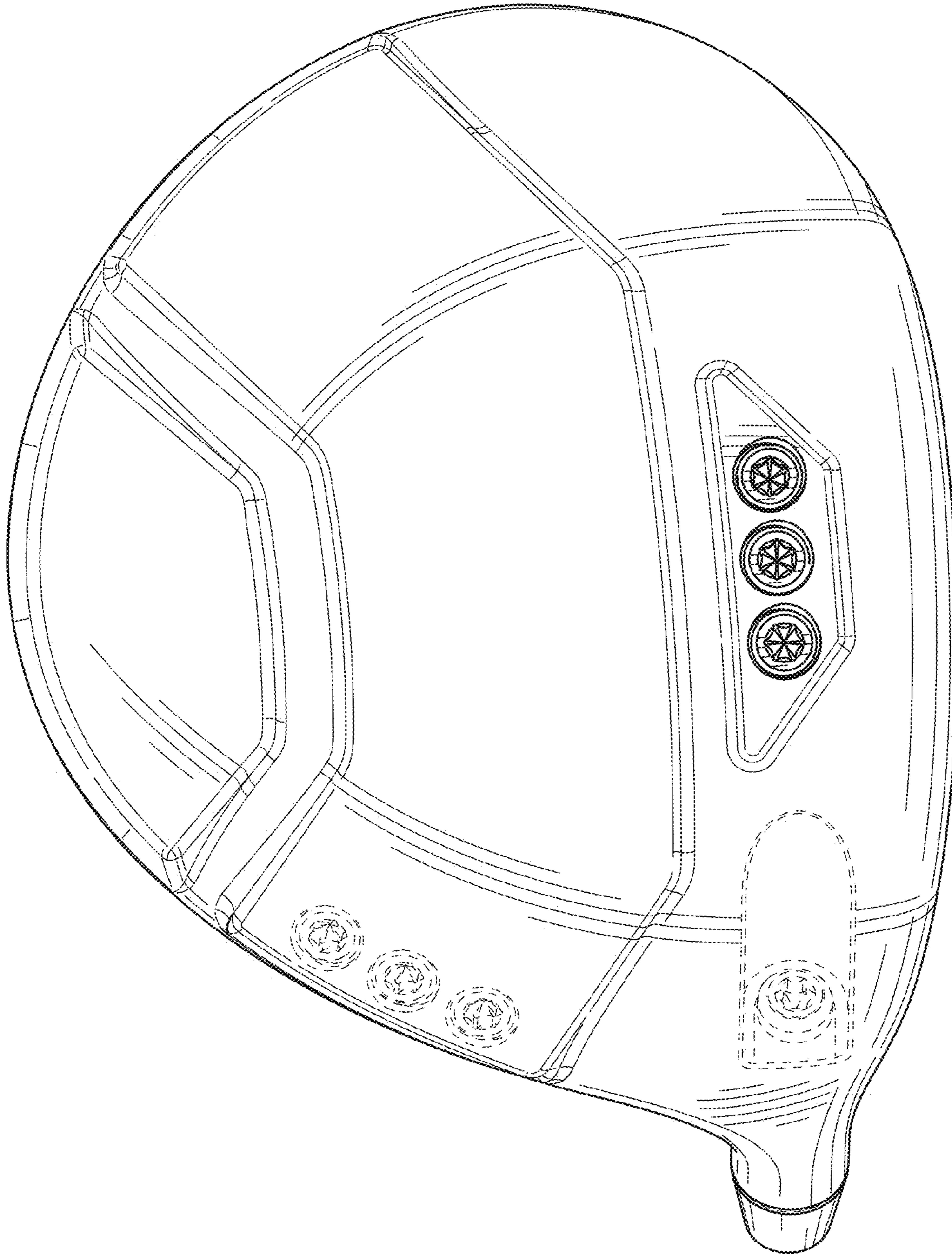

FIG. 22



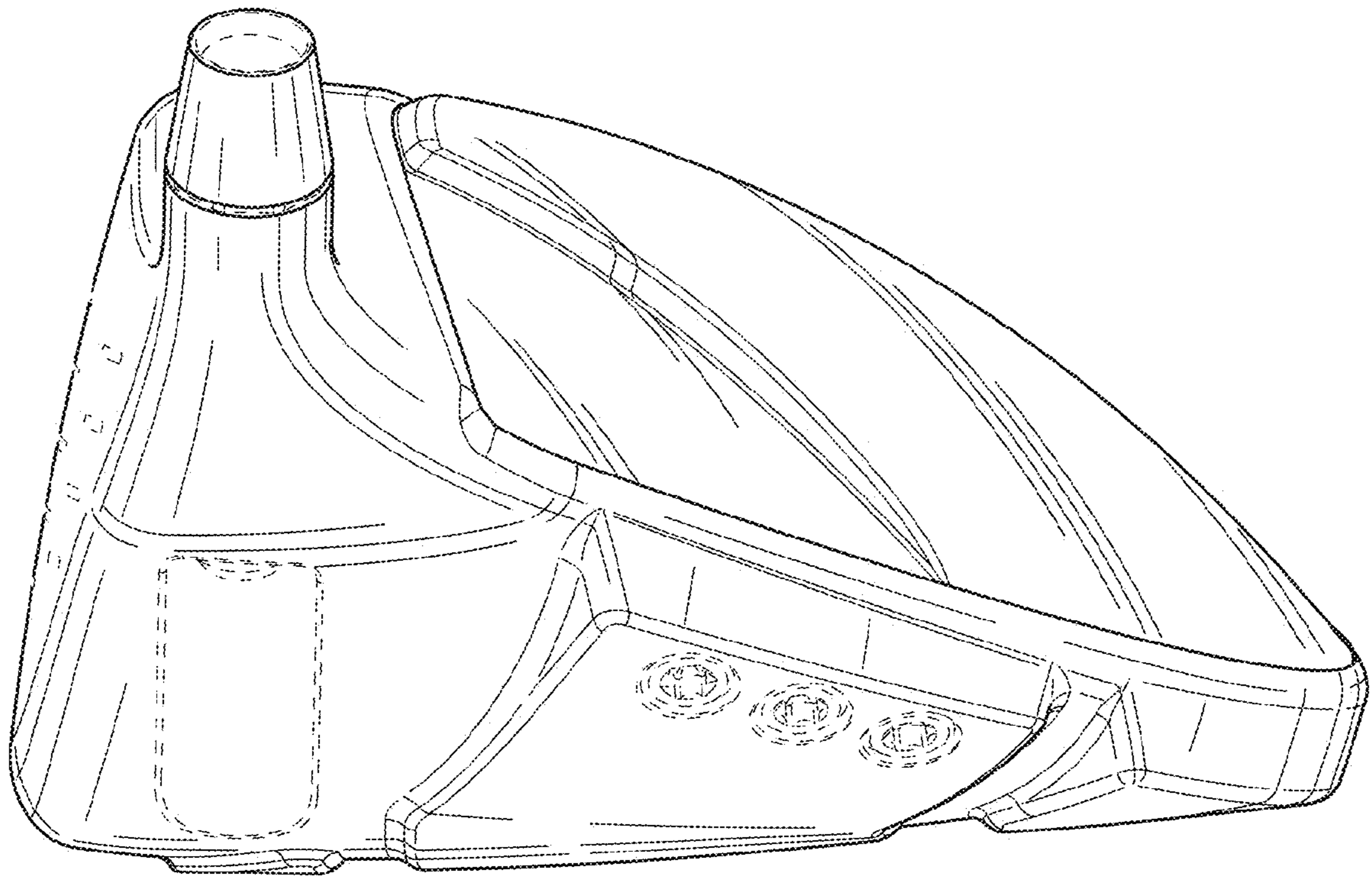

FIG. 22

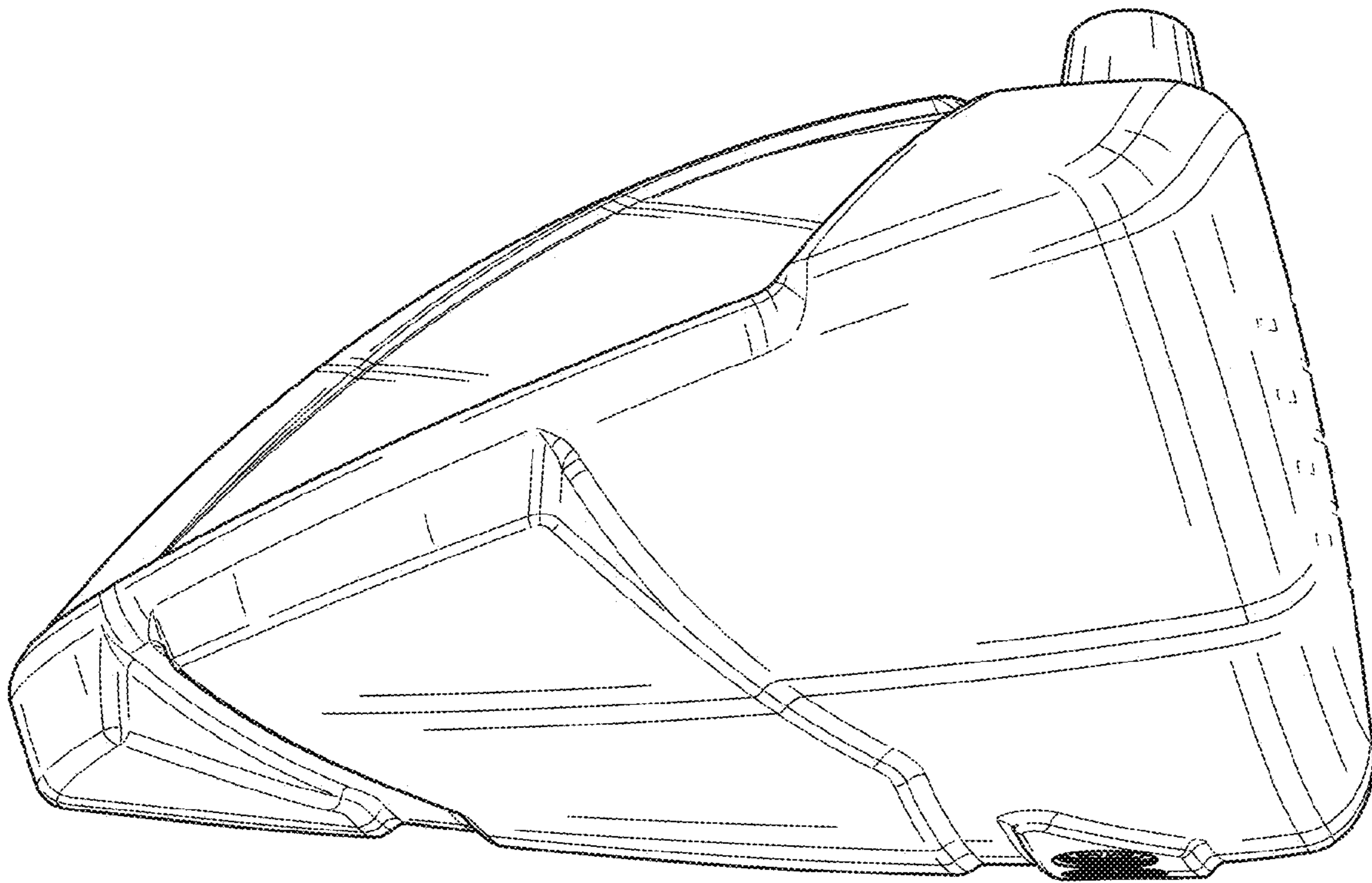

FIG. 24

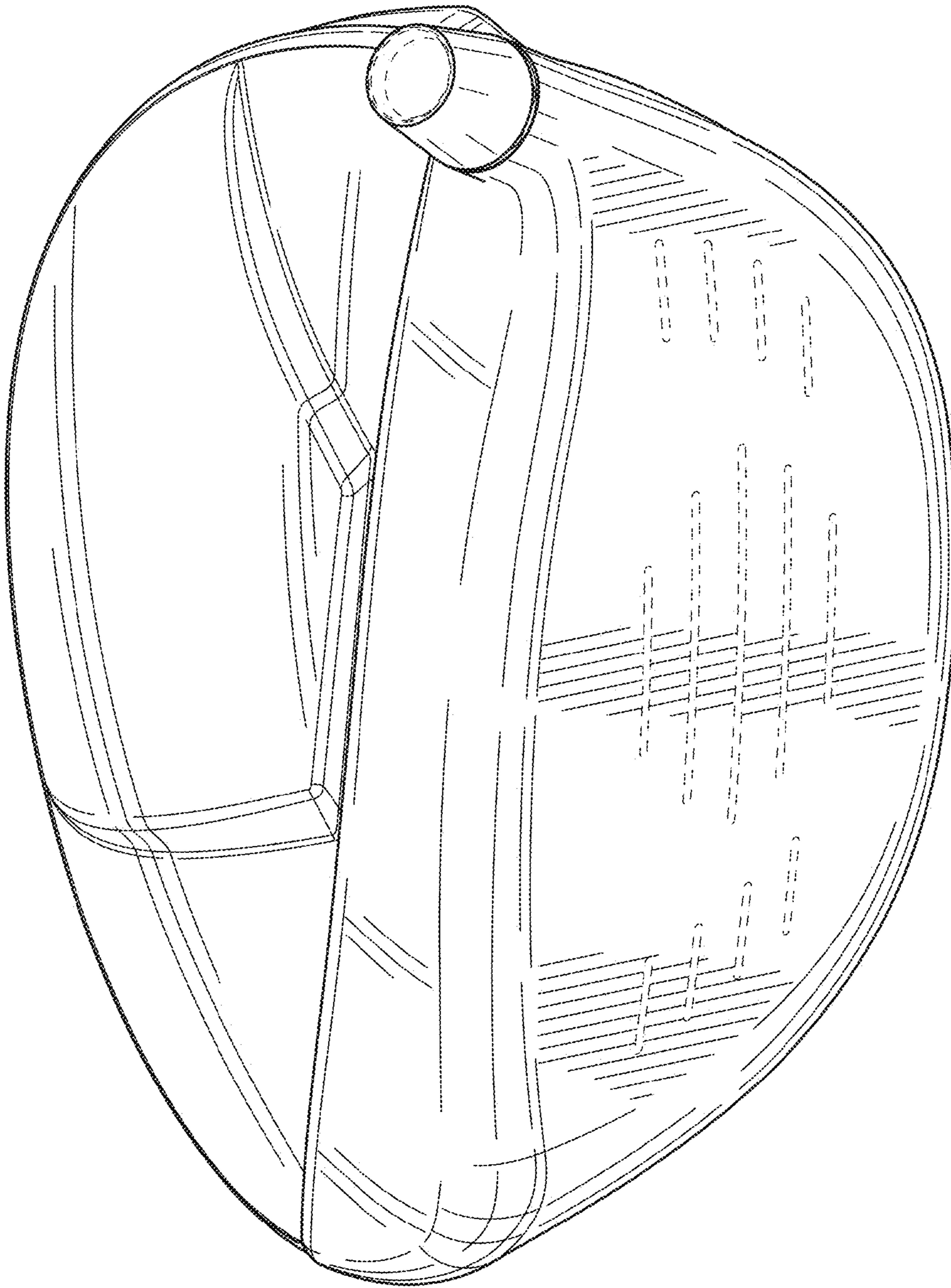

FIG. 25

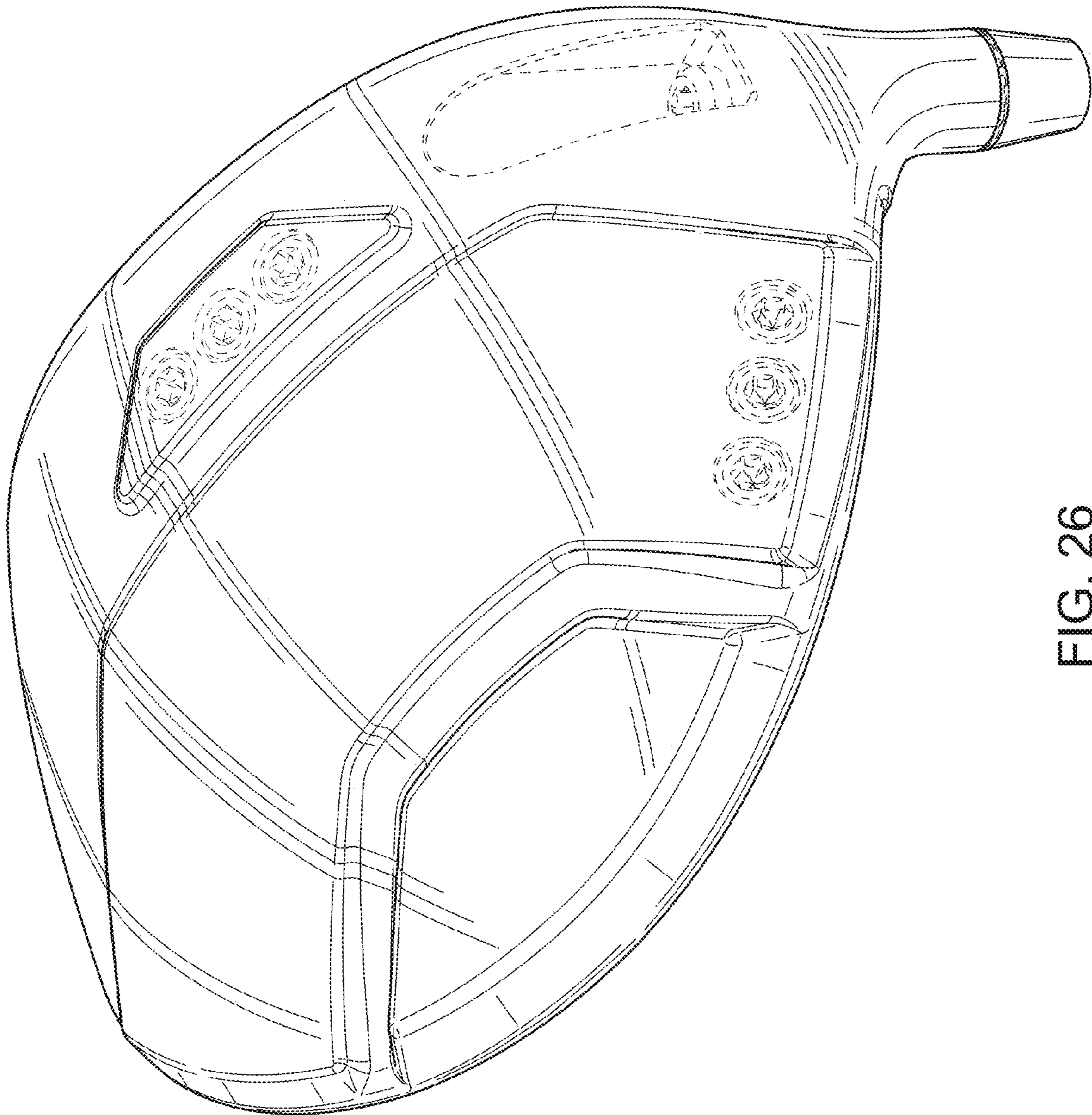

FIG. 26

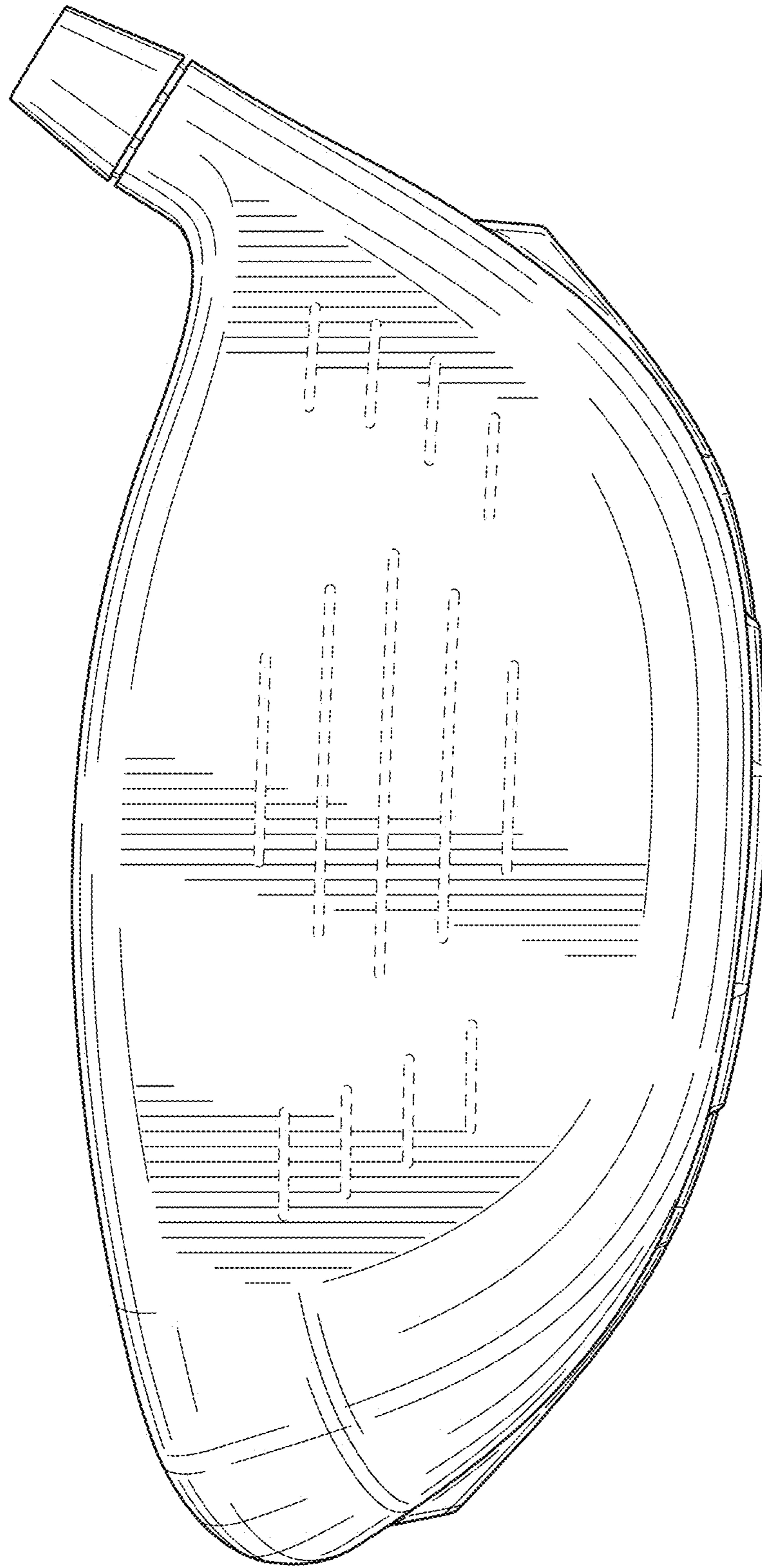

FIG. 27

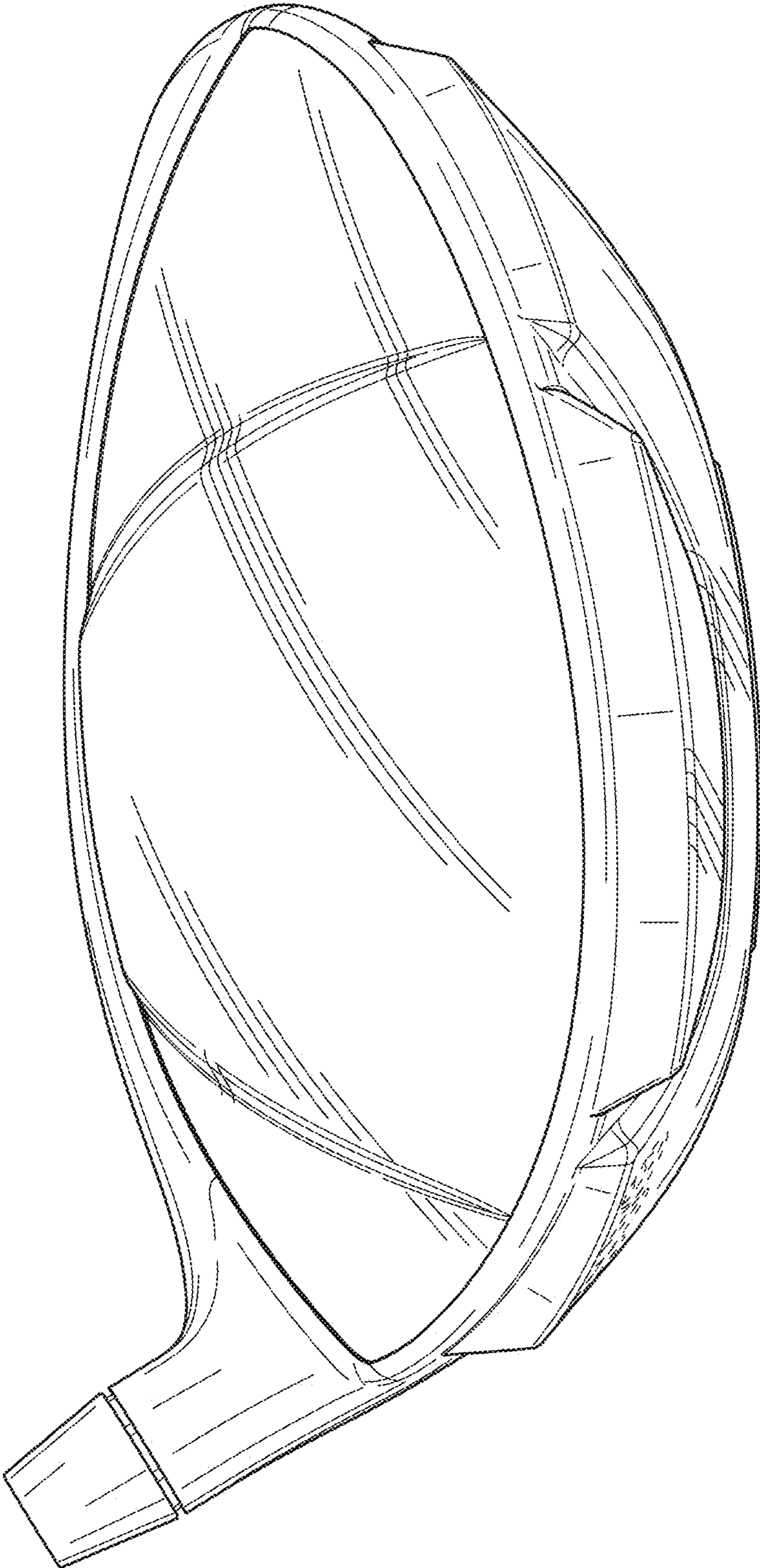

FIG. 28

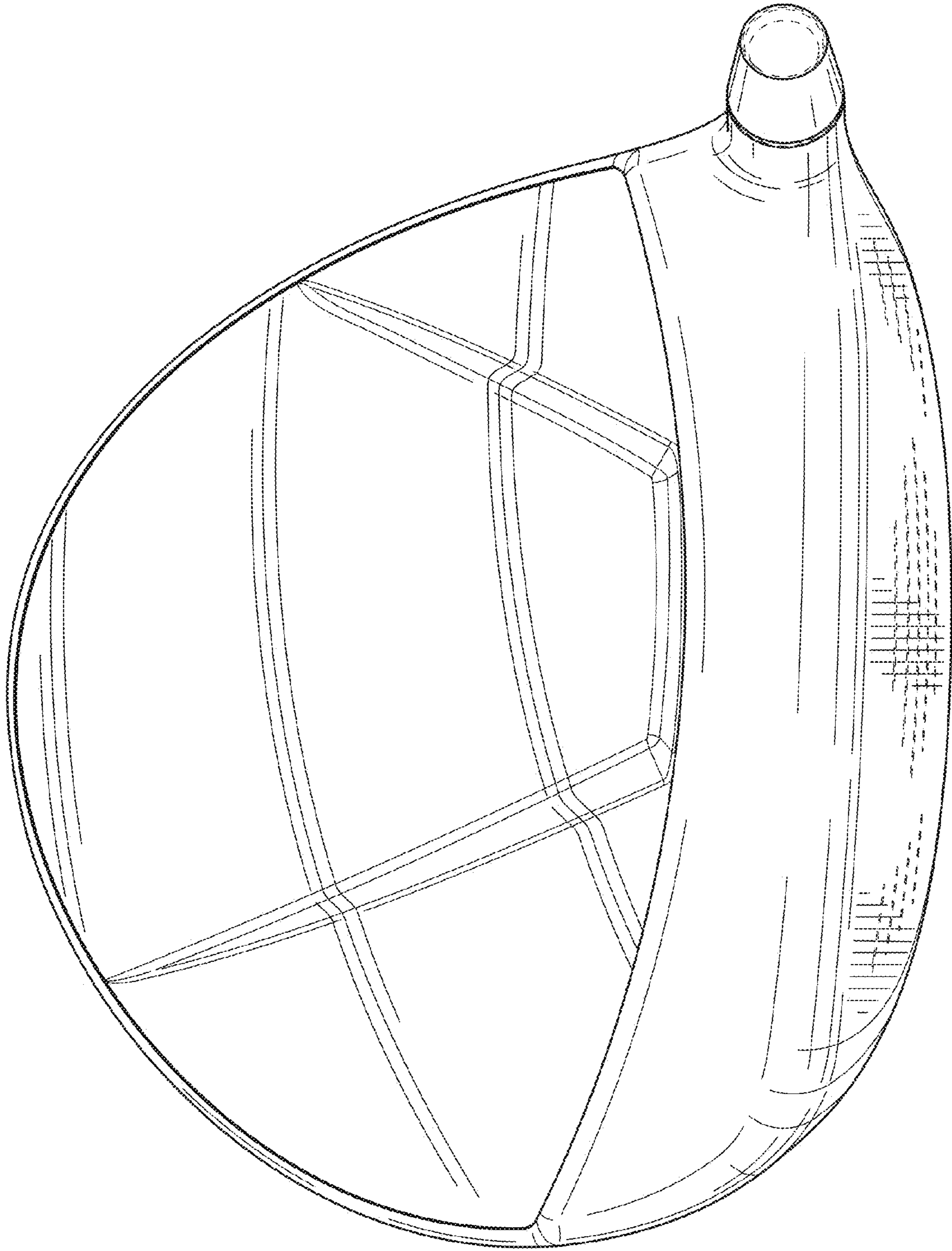

FIG. 29

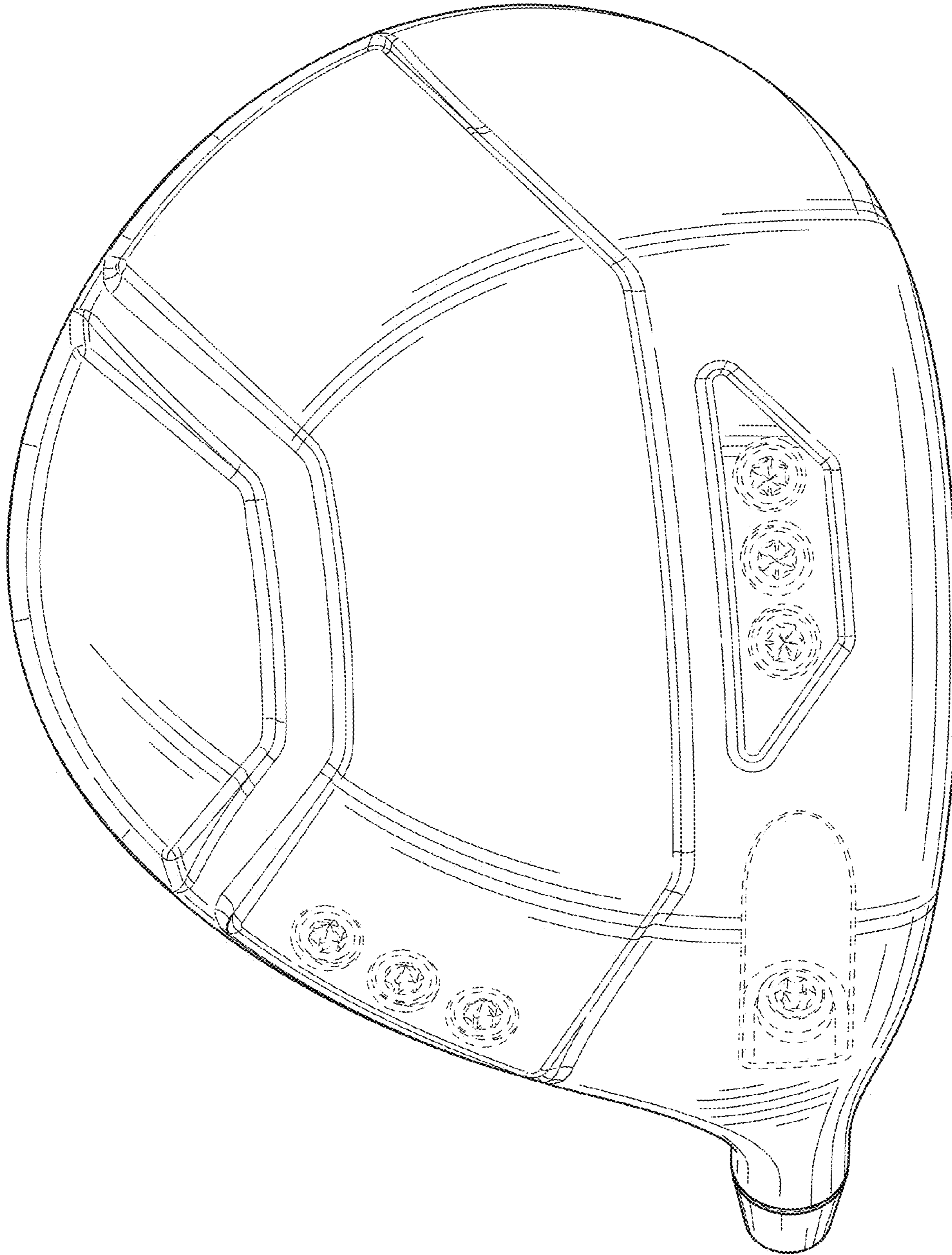

FIG. 30

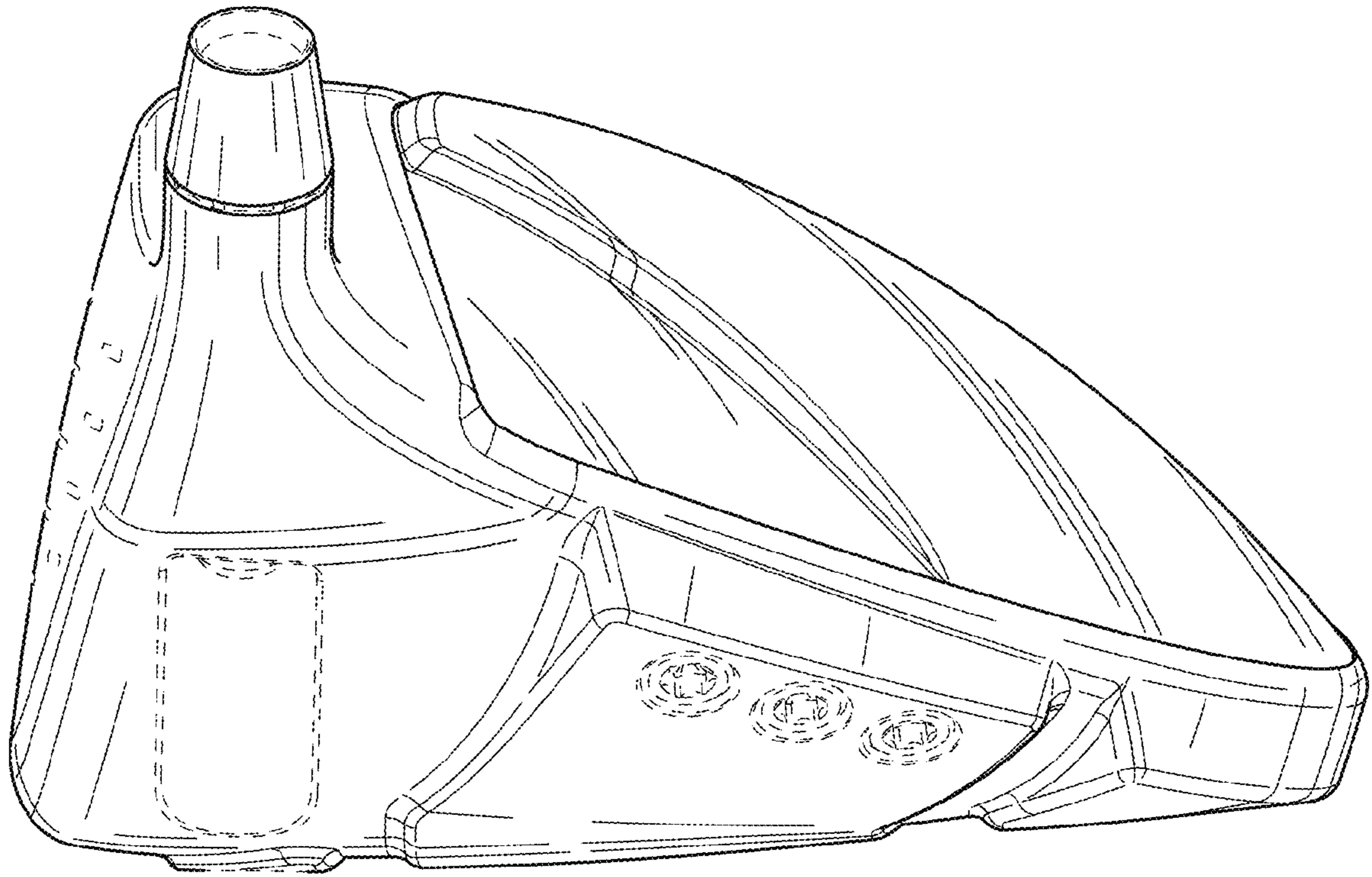

FIG. 31

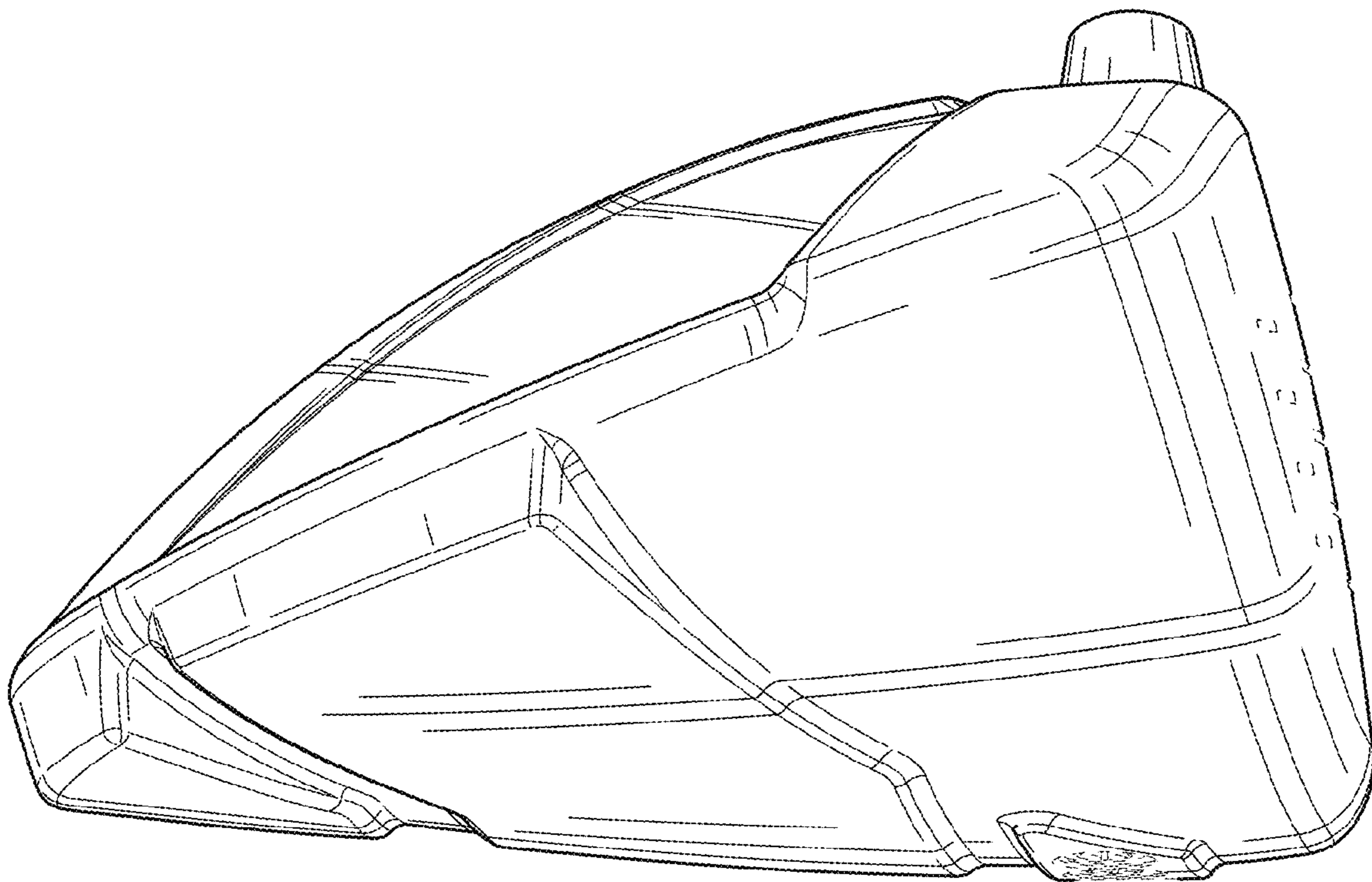

FIG. 32



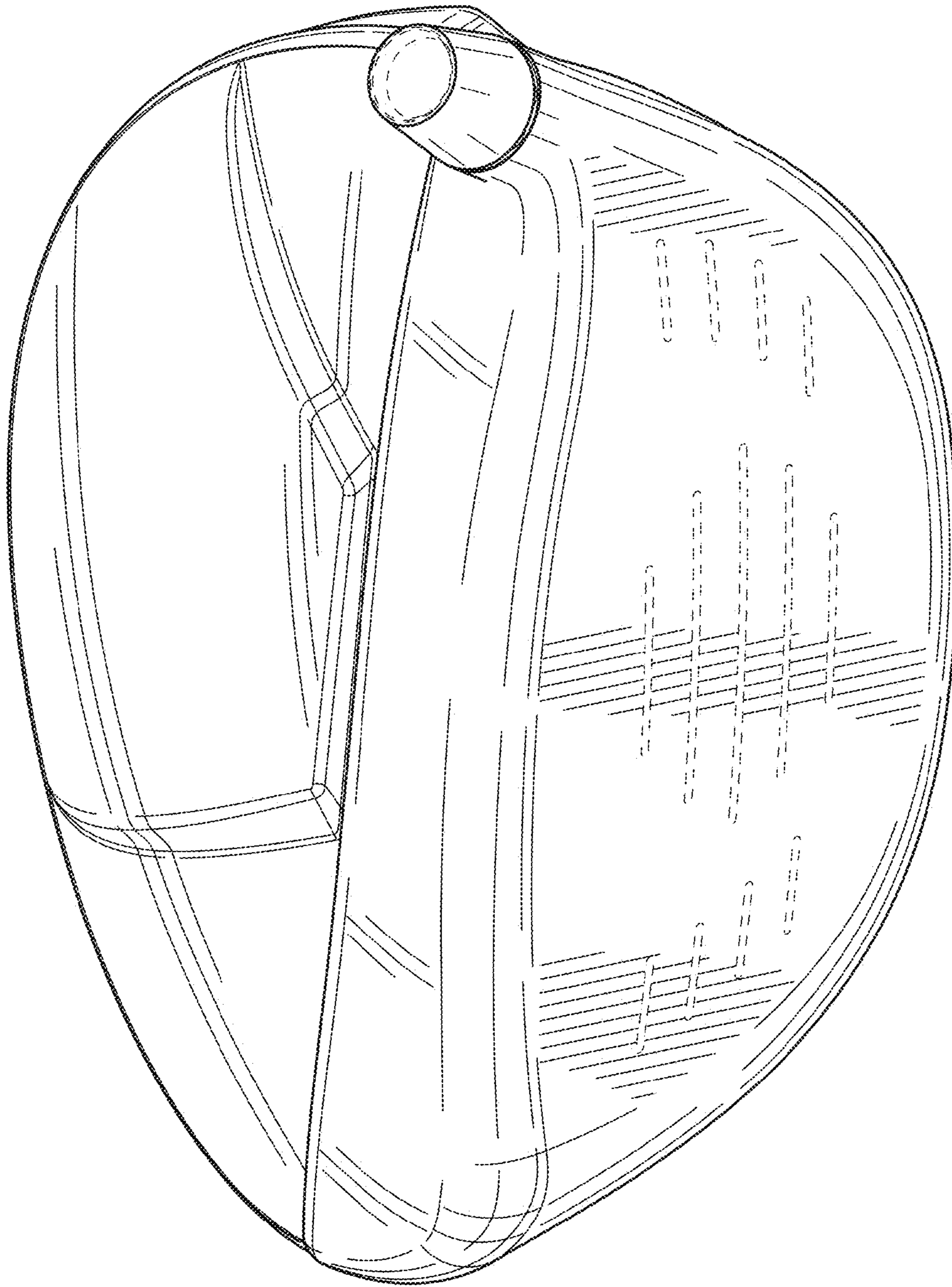

FIG. 33

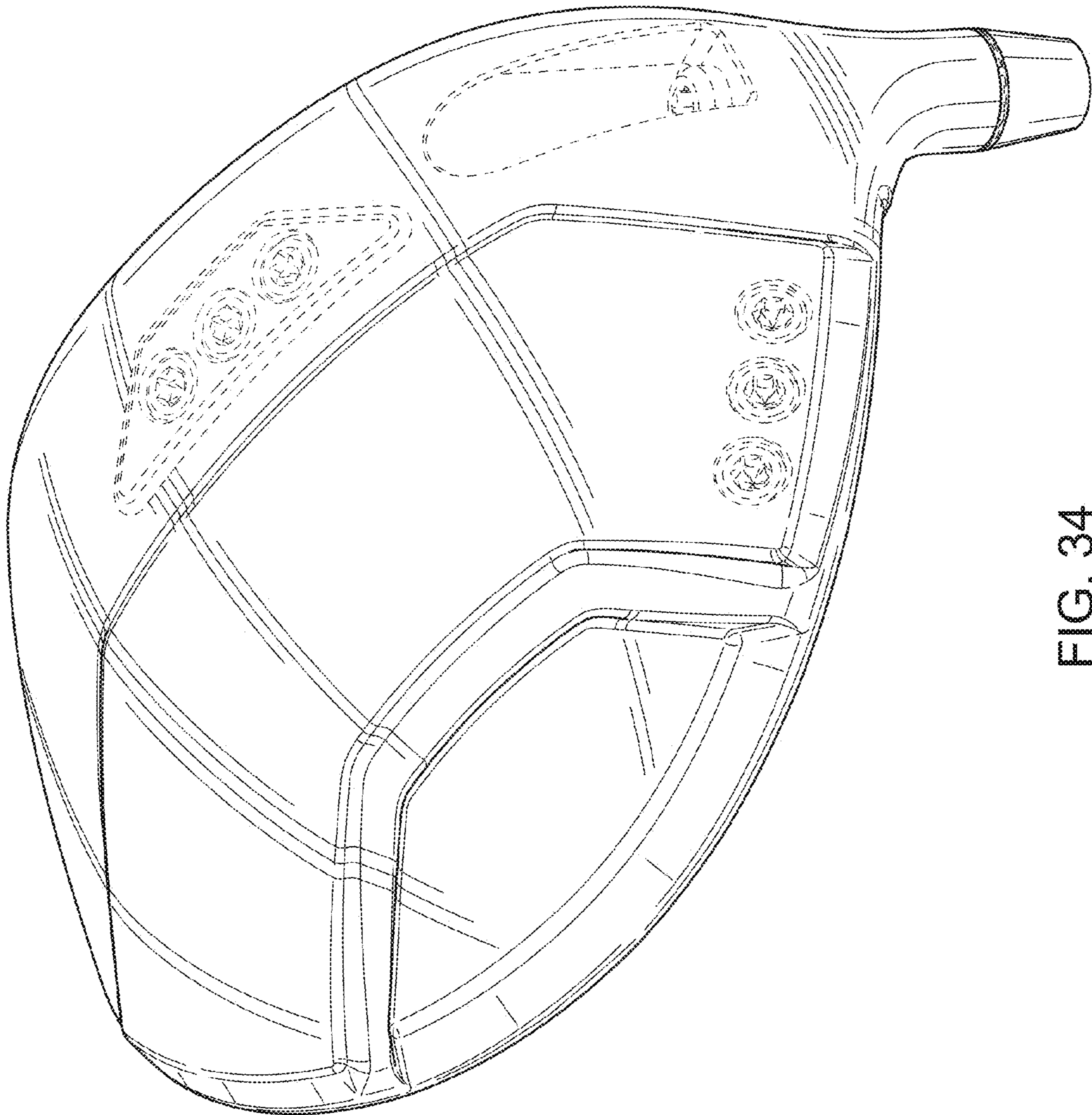

FIG. 34

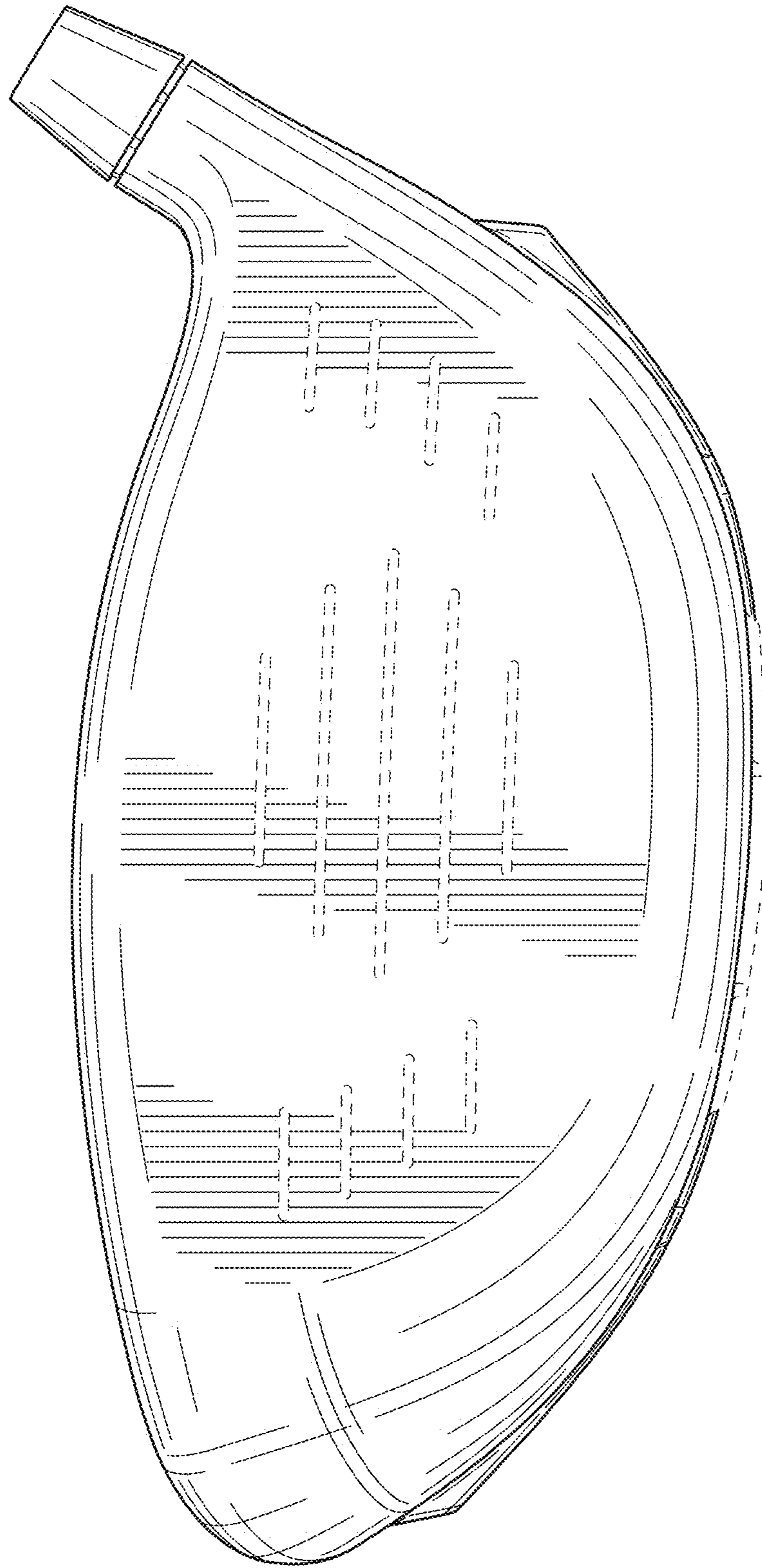

FIG. 35

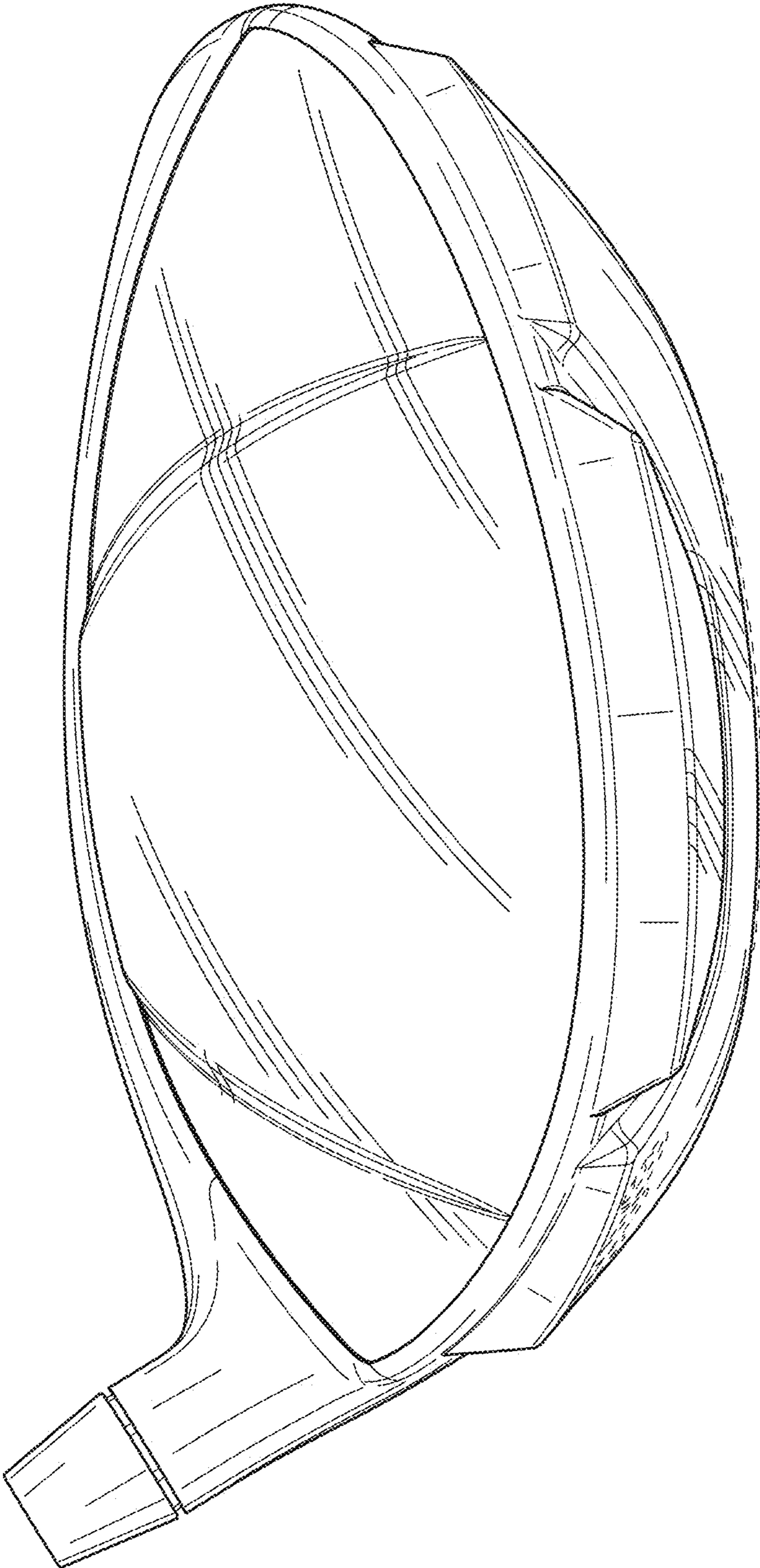

FIG. 36

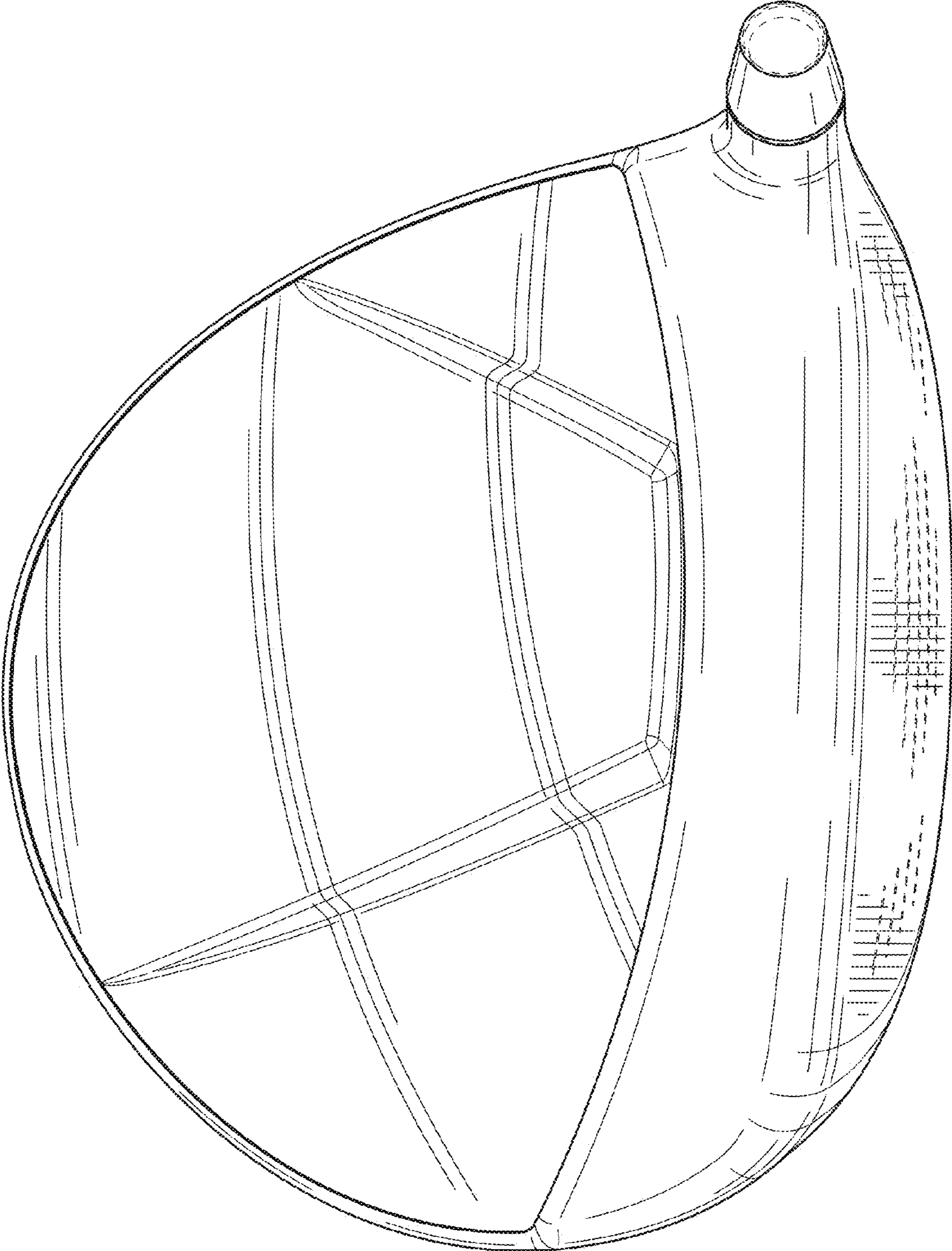

FIG. 37

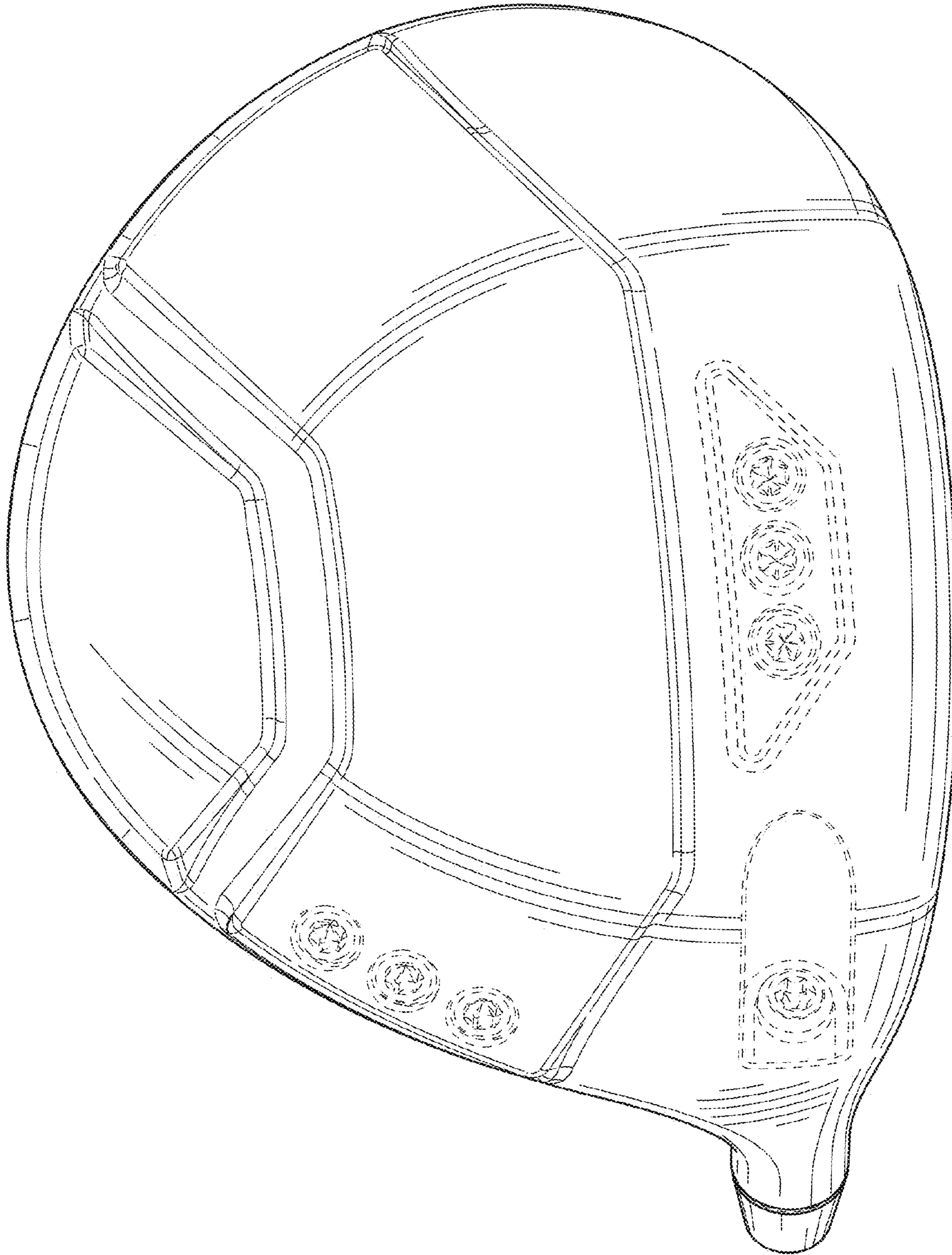

FIG. 38

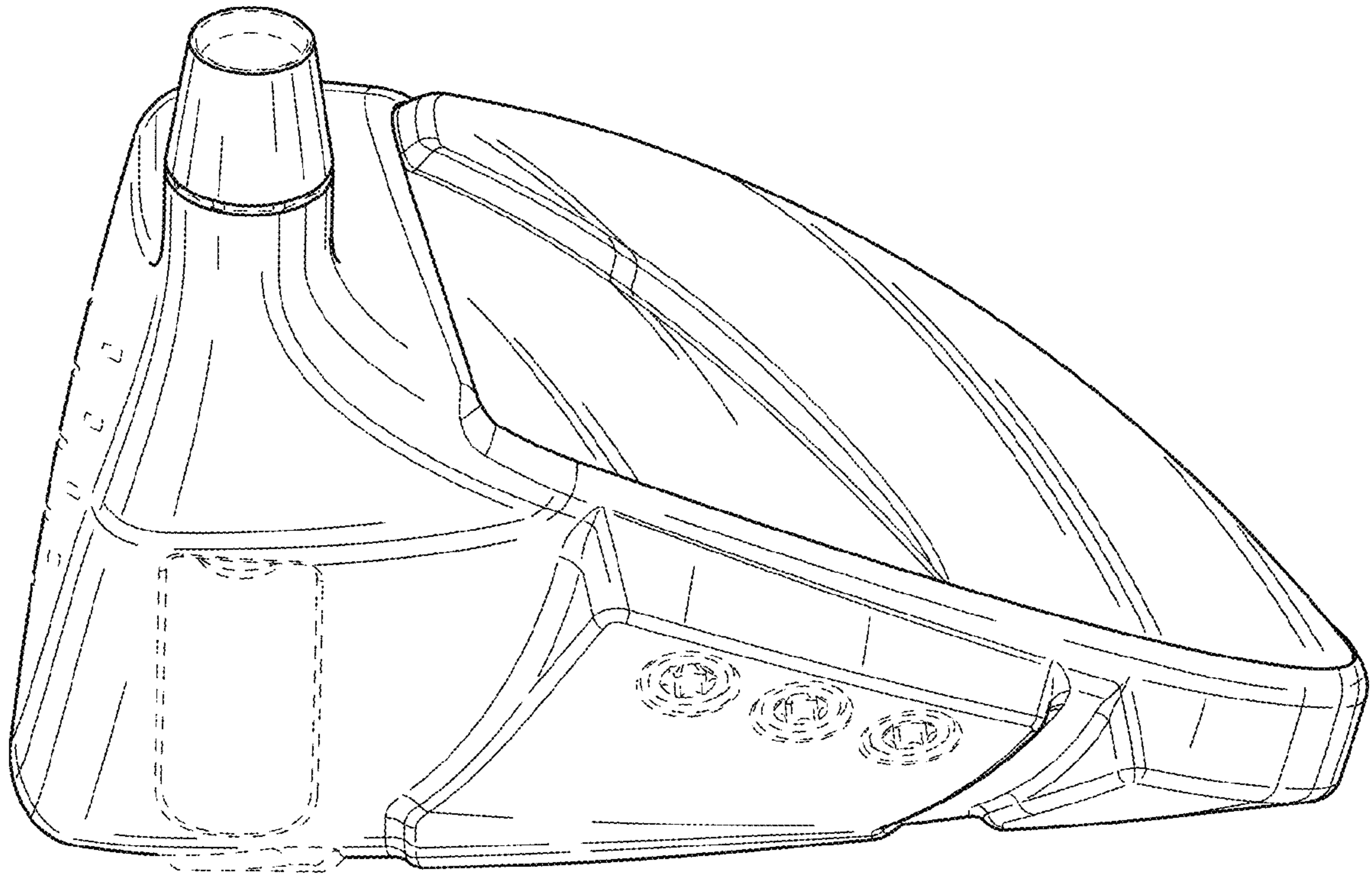

FIG. 39

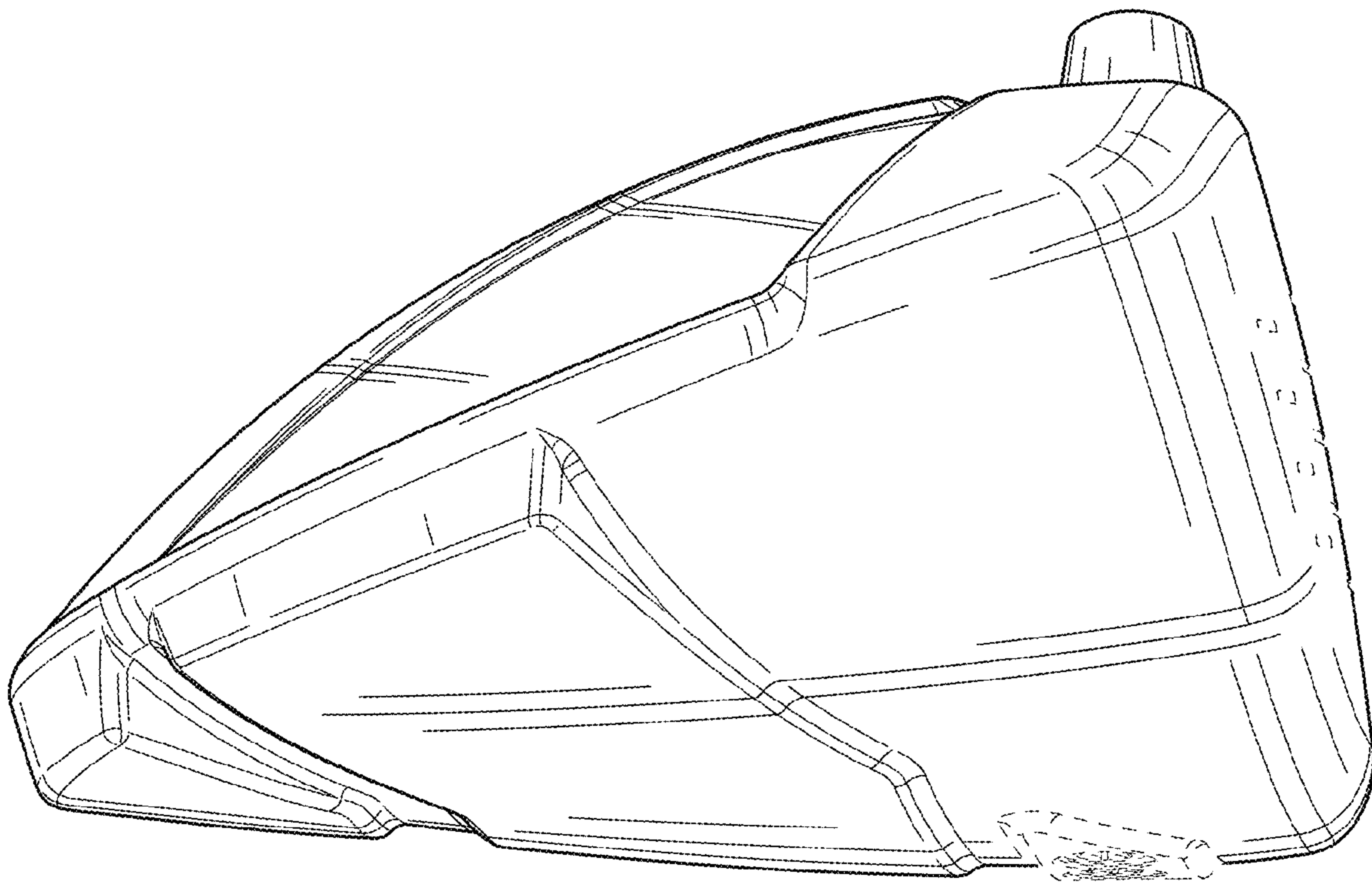

FIG. 40